

MOUNTING AND WIRING INSTRUCTIONS

- CAUTION:** 1-TURN OFF ELECTRICITY AT MAIN FUSE BOX BEFORE INSTALLATION.
 2-RISK OF FIRE. DO NOT LAMP FIXTURE GREATER THAN WATTAGE SHOWN ON MAXIMUM WATTAGE LABELS ON FIXTURE.
 3-IF YOU ARE UNFAMILIAR WITH ELECTRIC WIRING CALL A QUALIFIED ELECTRICIAN TO INSTALL THIS UNIT.

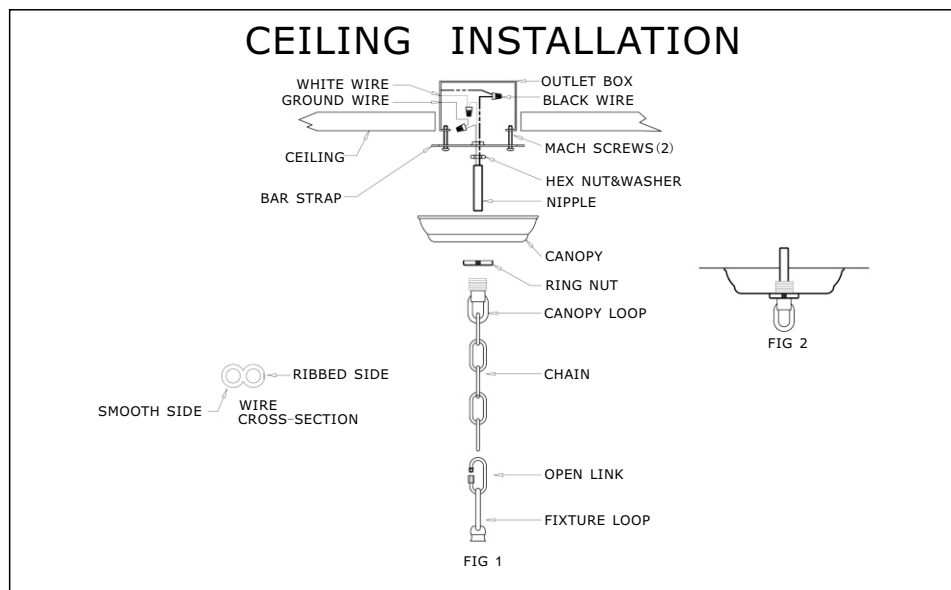

- 1-FASTEN BAR STRAP TO OUTLET BOX WITH (2) SCREWS.
- 2-ASSEMBLE NIPPLE AND HEX NUT TO BAR STRAP SO THAT THE LOOP WILL ASSEMBLE AS IN FIGURE 2. LOCK NIPPLE IN PLACE WITH HEX NUT.
- 3-DETERMINE THE LENGTH OF CHAIN YOU NEED FOR FIXTURE HEIGHT AND THEN CONNECT THE CHAIN TO THE FIXTURE USING THE OPEN LINK. CLOSE THE LINK (USE A CLOTH BETWEEN THE LINK AND PLIERS TO PROTECT FINISH).
- 4-LACE THE WIRES THROUGH THE CHAIN (EVERY OTHER LINK) AND STOP JUST BEFORE YOU REACH THE CANOPY LOOP.
- 5-PASS THE RING NUT AND CANOPY DOWN THE CHAIN.
- 6-A SECOND PERSON MAY BE NEEDED TO ASSIST IN THIS STEP. RAISE THE FIXTURE TO THE OUTLET BOX AND SCREW THE LOOP ONTO THE NIPPLE.
- 7-PASS THE REMAINDER OF THE WIRE THROUGH THE CANOPY LOOP AND PULL OUT OF OUTLET BOX.
- 8-SPLICE THE RIBBED SIDE OF THE PARALLEL WIRE TO THE WHITE SUPPLY WIRE FROM THE OUTLET BOX WITH WIRE CONNECTOR (NOT SUPPLIED). SPLICE THE SMOOTH SIDE OF THE PARALLEL WIRE TO THE BLACK SUPPLY WIRE FROM THE OUTLET BOX WITH WIRE CONNECTOR. SPLICE GROUND WIRE TO SUPPLY GROUND WIRE WITH WIRE CONNECTOR. PUSH ALL WIRES BACK INTO OUTLET BOX.
- 9-RAISE CANOPY AND SECURE WITH RING NUT. TURN ELECTRICITY BACK ON.

INSTALLATION

1. SCREW THE CENTER ROD [A] TO THE LIGHTING FIXTURE [B].
2. PUT THE GLASS SHADE [C] ONTO THE LIGHTING FIXTURE [B], THEN TIGHTEN BY SOCKET RING [D].
3. INSTALL BULB [E]. (BULB NOT INCLUDED)

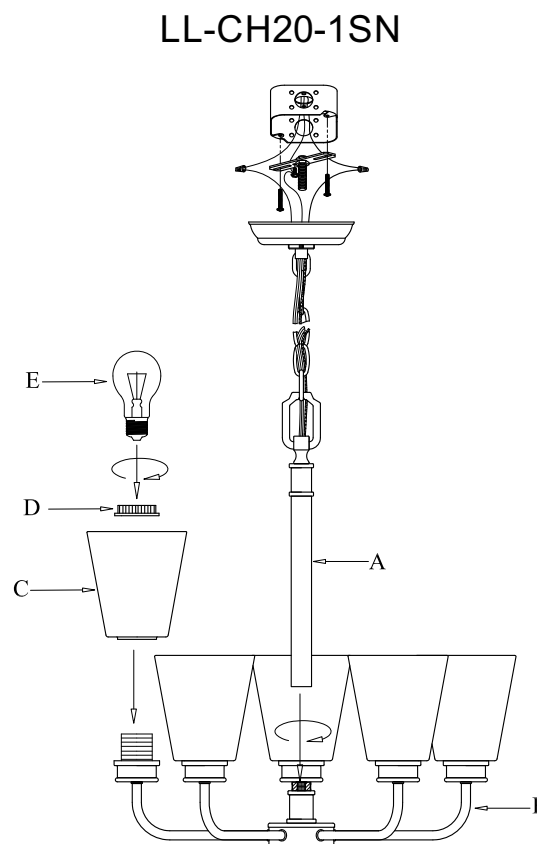

CAUTION: PULL ANY EXCESS WIRE THROUGH BOTTOM OF THE LAMP. PLEASE USE TYPE A/ CFL BULB. DO NOT USE LIGHT BULB RATED GREATER THAN 60W / 26W. OR THE LAMP MAY BURN AND CAUSE A FIRE! TO CLEAN, USE A SOFT CLOTH ONLY.

NOTE: TURN THE POWER OFF (UNPLUG FROM THE WALL OUTLET) BEFORE REPLACING THE BULB. MAKE SURE THE BULB HAS SUFFICIENT TIME TO COOL DOWN. DO NOT SUBJECT THE LAMP TO ANY SHOCK WHILE LIT AS SHATTERING OF LAMP MAY RESULT.



INSTALLATION INSTRUCTION FOR PENDANT LAMP

SAFETY PRECAUTIONS:

1. TURN OFF ELECTRICAL POWER BEFORE STARTING INSTALLATION OF LIGHT FIXTURE.
DO NOT REMOVE INSULATION FROM FIXTURE.
2. THIS PRODUCT MUST BE INSTALLED IN ACCORDANCE WITH THE APPLICABLE INSTALLATION CODE BY A PERSON FAMILIAR WITH THE CONSTRUCTION AND OPERATION OF THE PRODUCT AND THE HAZARDS INVOLVED.
3. CONNECT THE GROUND WIRE (BARE COPPER OR GREEN) FROM YOUR FIXTURE TO THE GROUND WIRE (BARE COPPER OR GREEN) OR GROUND SCREW IN THE ELECTRICAL OUTLET BOX.

INSTALLATION:

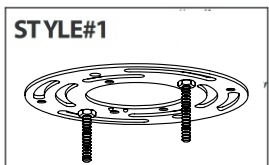

1. Refer to the mounting bracket style that matches the bracket that is included with your fixture.

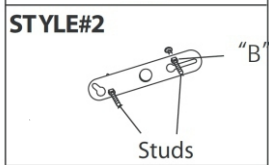

Style#1 -Loosen hex nut "A" and "B". Adjust stud so it clears the fixture once assembled. Hold in place with "A" and lock in place with "B".

Style#2 (Threaded holes) Loosen "B". Adjust stud to desired length and lock in place with "B".

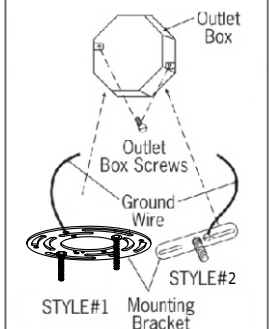

2. Attach the mounting bracket to outlet box using outlet box screws. (not included).

3. Adjusting the length of flexible cord. For safety, do not release the knot inside canopy.

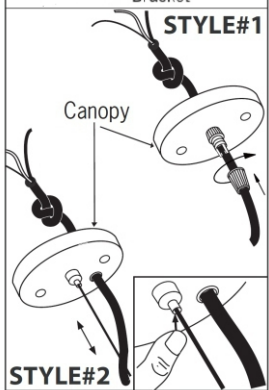

STYLE #1- Loosen the plastic screw for adjusting the length of flexible cord. Re-tighten plastic screw after adjusting.

STYLE #2- Adjust the height of the fixture by pushing the button. Ensure the cord does not touch the light bulb(s) when adjusting the height of the fixture or the steel cable(s).

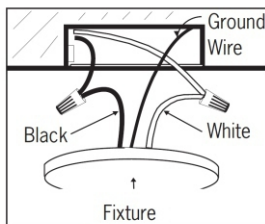

4. Connect the ground wire (bare copper or green) from your fixture to the ground wire (bare copper or green) or ground screw in the electrical outlet box. Connect the black wire (or wire with marketing) from the fixture to the black wire in the electrical box and connect the white wire from the fixture to the white wire in the electrical box.

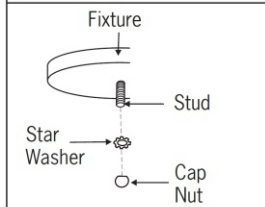

5. Tuck electrical wires into outlet box and position fixture over studs or nipple on mounting bracket assembly. Secure fixture in place with star washer(s) and cap nut(s).

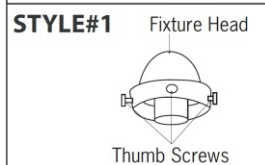

6. Mounting Glass To Fixture
NOTE: Refer to the style of assembly that matches the style of your fixture.

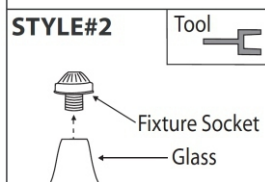

STYLE #1-Using thumb screws provided, attach the glass to the fixture head. Place the glass into the fixture head and tighten screws into the groove or holes in the glass.

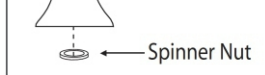

STYLE #2-Remove spinner nut from socket. Position glass on lamp and secure with spinner nut. On some fixtures, a tool is included to attach the spinner nut.

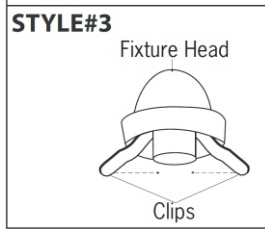

STYLE #3-Squeeze the two clips together around the socket. Slide the glass over the clips, then push the glass up snug to the fixture head.

7. If not already done, install proper bulb type and wattage (not included).

INSTALLATION

1. INSTALL BULBS. (BULBS NOT INCLUDED)
2. PUT THE GLASS SHADE [A] ONTO IRON PENAL [B], THEN PLACE DECORATIVE PART [C] ONTO GLASS SHADE [A] AND TIGHTEN BY SCREWS [D].
3. SCREW THE RODS [F] AND CANOPY TO THE FIXTURE [E].
4. ATTACH THE CIRCLE CROSS BAR TO THE OUTLET BOX USING OUTLET BOX SCREWS.
5. PLACE THE CANOPY ONTO THE CIRCLE CROSS BAR, THEN SCREW WITH FINIAL [G].

LL-CH319-3SB

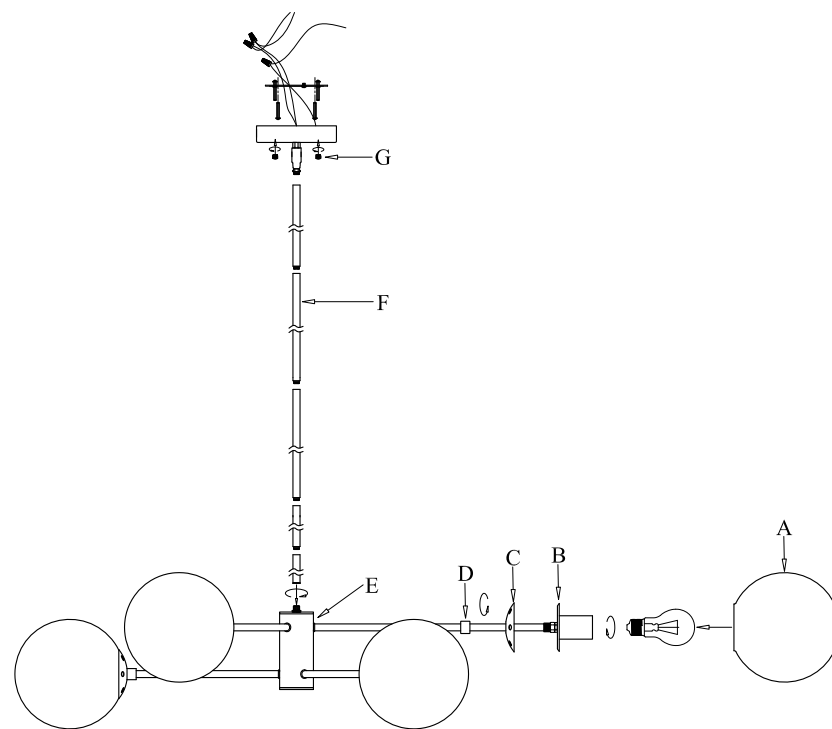

CAUTION: PULL ANY EXCESS WIRE THROUGH BOTTOM OF THE LAMP. PLEASE USE TYPE A / CFL BULB. DO NOT USE LIGHT BULB RATED GREATER THAN 60W / 18W OR THE LAMP MAY BURN AND CAUSE A FIRE! TO CLEAN, USE A SOFT CLOTH ONLY.

NOTE: TURN THE POWER OFF (UNPLUG FROM THE WALL OUTLET) BEFORE REPLACING THE BULB. MAKE SURE THE BULB HAS SUFFICIENT TIME TO COOL DOWN. DO NOT SUBJECT THE LAMP TO ANY SHOCK WHILE LIT AS SHATTERING OF LAMP MAY RESULT.

INSTALLATION INSTRUCTION FOR PENDANT LAMP

SAFETY PRECAUTIONS:

1. TURN OFF ELECTRICAL POWER BEFORE STARTING INSTALLATION OF LIGHT FIXTURE.
DO NOT REMOVE INSULATION FROM FIXTURE.
2. THIS PRODUCT MUST BE INSTALLED IN ACCORDANCE WITH THE APPLICABLE INSTALLATION CODE BY A PERSON FAMILIAR WITH THE CONSTRUCTION AND OPERATION OF THE PRODUCT AND THE HAZARDS INVOLVED.
3. CONNECT THE GROUND WIRE (BARE COPPER OR GREEN) FROM YOUR FIXTURE TO THE GROUND WIRE (BARE COPPER OR GREEN) OR GROUND SCREW IN THE ELECTRICAL OUTLET BOX.

INSTALLATION:

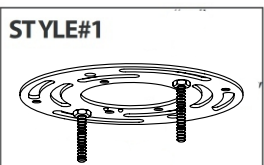

1. Refer to the mounting bracket style that matches the bracket that is included with your fixture.

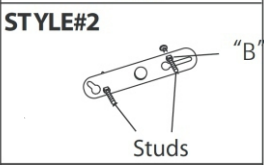

Style#1 -Loosen hex nut "A" and "B". Adjust stud so it clears the fixture once assembled. Hold in place with "A" and lock in place with "B".

Style#2 (Threaded holes) Loosen "B". Adjust stud to desired length and lock in place with "B".

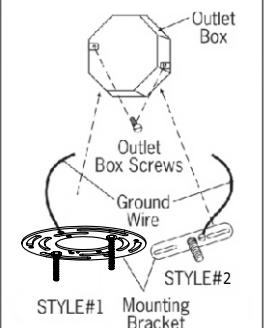

2. Attach the mounting bracket to outlet box using outlet box screws. (not included).

3. Adjusting the length of flexible cord. For safety, do not release the knot inside canopy.

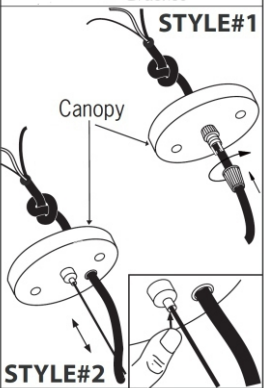

STYLE #1- Loosen the plastic screw for adjusting the length of flexible cord. Re-tighten plastic screw after adjusting.

STYLE #2- Adjust the height of the fixture by pushing the button. Ensure the cord does not touch the light bulb(s) when adjusting the height of the fixture or the steel cable(s).

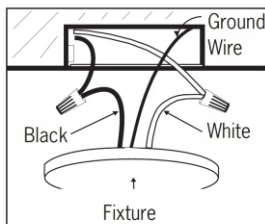

4. Connect the ground wire (bare copper or green) from your fixture to the ground wire (bare copper or green) or ground screw in the electrical outlet box. Connect the black wire (or wire with marketing) from the fixture to the black wire in the electrical box and connect the white wire from the fixture to the white wire in the electrical box.

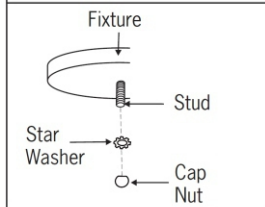

5. Tuck electrical wires into outlet box and position fixture over studs or nipple on mounting bracket assembly. Secure fixture in place with star washer(s) and cap nut(s).

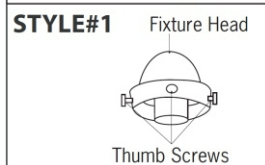

6. Mounting Glass To Fixture
NOTE: Refer to the style of assembly that matches the style of your fixture.

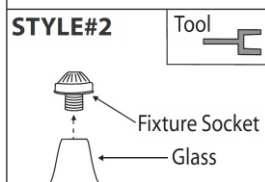

STYLE #1-Using thumb screws provided, attach the glass to the fixture head. Place the glass into the fixture head and tighten screws into the groove or holes in the glass.

STYLE #2-Remove spinner nut from socket. Position glass on lamp and secure with spinner nut. On some fixtures, a tool is included to attach the spinner nut.

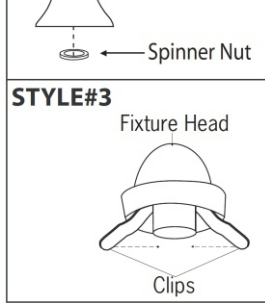

STYLE #3-Squeeze the two clips together around the socket. Slide the glass over the clips, then push the glass up snug to the fixture head.

7. If not already done, install proper bulb type and wattage (not included).

INSTALLATION

1. CAREFULLY PULL CORD [B] THROUGH HOLE IN UPPER BOX AND ADJUST THE CORD LENGTH.
2. CONNECT THE FIXTURE [A] TO THE UPPER BOX BY HOOKING EACH FIXTURE ARM [E1], [E2], [E3] INTO CORRESPONDING EYELETS [D].
3. SCREW THE RODS [F] AND CANOPY [G] TO THE SCREW ON UPPER BOX.
4. ATTACH THE CIRCLE CROSS BAR TO THE OUTLET BOX USING OUTLET BOX SCREWS.
5. PLACE THE CANOPY [G] ONTO THE CIRCLE CROSS BAR, THEN SCREW WITH FINIAL [H].
6. INSTALL BULBS. (BULBS INCLUDED)

LL-CH4-24-5BLK / LL-CH4-36-5BLK

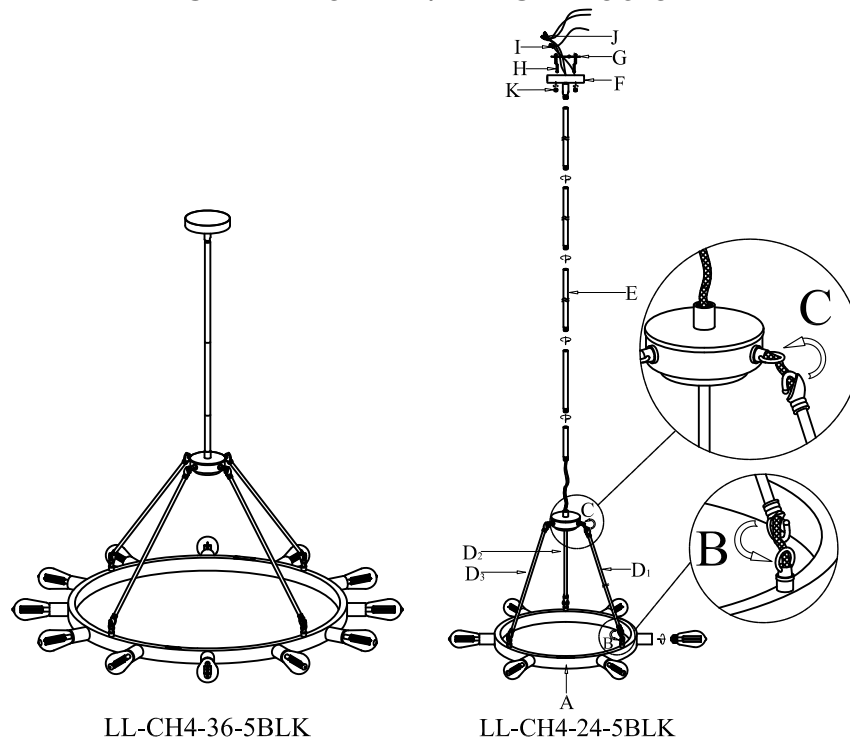

LL-CH4-36-5BLK

LL-CH4-24-5BLK

CAUTION: PULL ANY EXCESS WIRE THROUGH BOTTOM OF THE LAMP. PLEASE USE TYPE ST19 LED BULB. DO NOT USE LIGHT BULB RATED GREATER THAN 4 WATTS OR THE LAMP MAY BURN AND CAUSE A FIRE! TO CLEAN, USE A SOFT CLOTH ONLY.

NOTE: TURN THE POWER OFF (UNPLUG FROM THE WALL OUTLET) BEFORE REPLACING THE BULB. MAKE SURE THE BULB HAS SUFFICIENT TIME TO COOL DOWN. DO NOT SUBJECT THE LAMP TO ANY SHOCK WHILE LIT AS SHATTERING OF LAMP MAY RESULT.

INSTALLATION INSTRUCTION FOR PENDANT LAMP

SAFETY PRECAUTIONS:

1. TURN OFF ELECTRICAL POWER BEFORE STARTING INSTALLATION OF LIGHT FIXTURE.
DO NOT REMOVE INSULATION FROM FIXTURE.
2. THIS PRODUCT MUST BE INSTALLED IN ACCORDANCE WITH THE APPLICABLE INSTALLATION CODE BY A PERSON FAMILIAR WITH THE CONSTRUCTION AND OPERATION OF THE PRODUCT AND THE HAZARDS INVOLVED.
3. CONNECT THE GROUND WIRE (BARE COPPER OR GREEN) FROM YOUR FIXTURE TO THE GROUND WIRE (BARE COPPER OR GREEN) OR GROUND SCREW IN THE ELECTRICAL OUTLET BOX.

INSTALLATION:

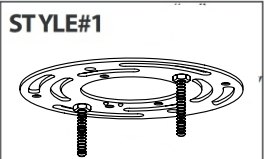

STYLE#1
1. Refer to the mounting bracket style that matches the bracket that is included with your fixture.

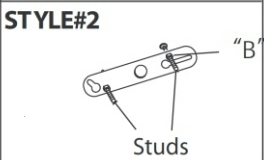

STYLE#2
Style#1 -Loosen hex nut "A" and "B". Adjust stud so it clears the fixture once assembled. Hold in place with "A" and lock in place with "B".

Style#2 (Threaded holes)
Loosen "B". Adjust stud to desired length and lock in place with "B".

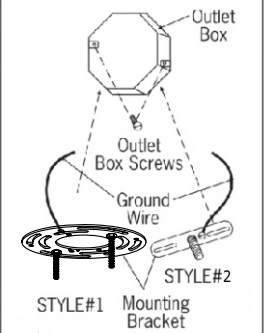

2. Attach the mounting bracket to outlet box using outlet box screws. (not included).

3. Adjusting the length of flexible cord. For safety, do not release the knot inside canopy.

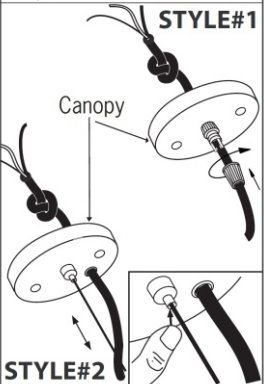

STYLE #1- Loosen the plastic screw for adjusting the length of flexible cord. Re-tighten plastic screw after adjusting.

STYLE #2- Adjust the height of the fixture by pushing the button. Ensure the cord does not touch the light bulb(s) when adjusting the height of the fixture or the steel cable(s).

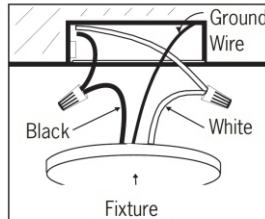

4. Connect the ground wire (bare copper or green) from your fixture to the ground wire (bare copper or green) or ground screw in the electrical outlet box. Connect the black wire (or wire with marketing) from the fixture to the black wire in the electrical box and connect the white wire from the fixture to the white wire in the electrical box.

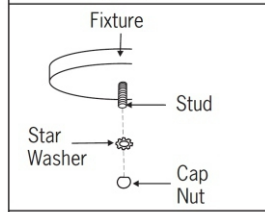

5. Tuck electrical wires into outlet box and position fixture over studs or nipple on mounting bracket assembly. Secure fixture in place with star washer(s) and cap nut(s).

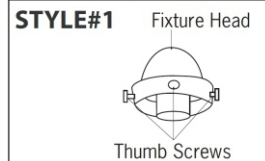

6. Mounting Glass To Fixture
NOTE: Refer to the style of assembly that matches the style of your fixture.

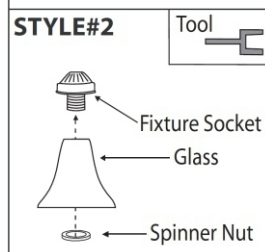

STYLE #1-Using thumb screws provided, attach the glass to the fixture head. Place the glass into the fixture head and tighten screws into the groove or holes in the glass.
STYLE #2-Remove spinner nut from socket. Position glass on lamp and secure with spinner nut. On some fixtures, a tool is included to attach the spinner nut.

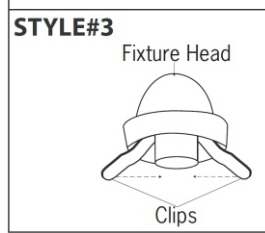

STYLE #3-Squeeze the two clips together around the socket. Slide the glass over the clips, then push the glass up snug to the fixture head.
7. If not already done, install proper bulb type and wattage (not included).

INSTALLATION

1. SCREW THE RODS [B] AND CANOPY [C] TO THE FIXTURE [A].
2. ATTACH THE CIRCLE CROSS BAR [D] TO THE OUTLET BOX USING OUTLET BOX SCREWS [E].
3. PLACE THE CANOPY [C] ONTO THE CIRCLE CROSS BAR [D], THEN SCREW WITH DECORATIVE NUT [H].
4. INSTALL BULBS. (BULBS INCLUDED)

LL-CH424-3SB / LL-CH424-1SN

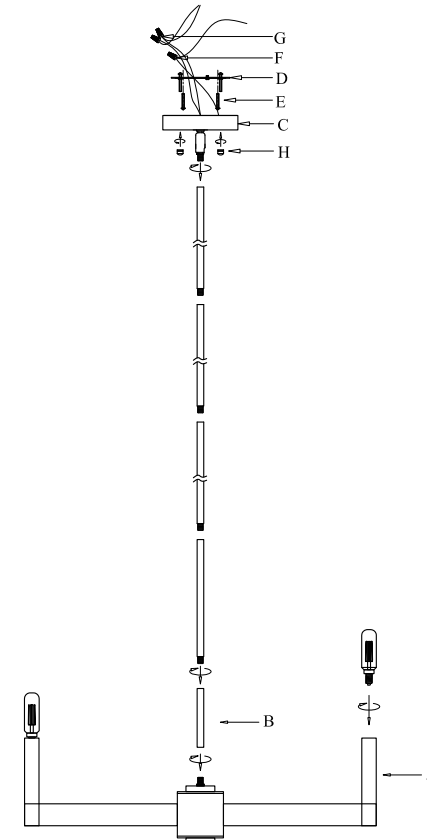

CAUTION: PULL ANY EXCESS WIRE THROUGH BOTTOM OF THE LAMP. PLEASE USE TYPE T8 BULB. DO NOT USE LIGHT BULB RATED GREATER THAN 3.5 WATT LED BULB. OR THE LAMP MAY BURN AND CAUSE A FIRE! TO CLEAN, USE A SOFT CLOTH ONLY.

NOTE: TURN THE POWER OFF (UNPLUG FROM THE WALL OUTLET) BEFORE REPLACING THE BULB. MAKE SURE THE BULB HAS SUFFICIENT TIME TO COOL DOWN. DO NOT SUBJECT THE LAMP TO ANY SHOCK WHILE LIT AS SHATTERING OF LAMP MAY RESULT.

INSTALLATION INSTRUCTION FOR PENDANT LAMP

SAFETY PRECAUTIONS:

1. TURN OFF ELECTRICAL POWER BEFORE STARTING INSTALLATION OF LIGHT FIXTURE.
DO NOT REMOVE INSULATION FROM FIXTURE.
2. THIS PRODUCT MUST BE INSTALLED IN ACCORDANCE WITH THE APPLICABLE INSTALLATION CODE BY A PERSON FAMILIAR WITH THE CONSTRUCTION AND OPERATION OF THE PRODUCT AND THE HAZARDS INVOLVED.
3. CONNECT THE GROUND WIRE (BARE COPPER OR GREEN) FROM YOUR FIXTURE TO THE GROUND WIRE (BARE COPPER OR GREEN) OR GROUND SCREW IN THE ELECTRICAL OUTLET BOX.

INSTALLATION:

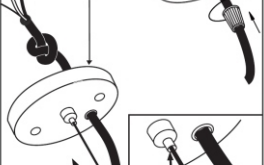
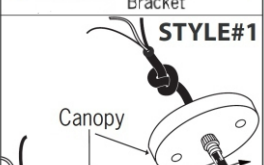
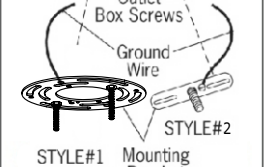
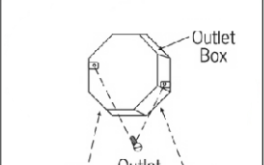
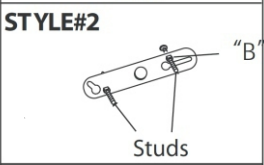
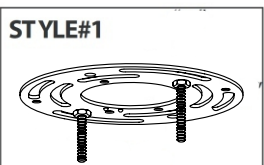

1. Refer to the mounting bracket style that matches the bracket that is included with your fixture.

Style#1 -Loosen hex nut "A" and "B". Adjust stud so it clears the fixture once assembled. Hold in place with "A" and lock in place with "B".

Style#2 (Threaded holes) Loosen "B". Adjust stud to desired length and lock in place with "B".

2. Attach the mounting bracket to outlet box using outlet box screws. (not included).

3. Adjusting the length of flexible cord. For safety, do not release the knot inside canopy.

STYLE #1- Loosen the plastic screw for adjusting the length of flexible cord. Re-tighten plastic screw after adjusting.

STYLE #2- Adjust the height of the fixture by pushing the button. Ensure the cord does not touch the light bulb(s) when adjusting the height of the fixture or the steel cable(s).

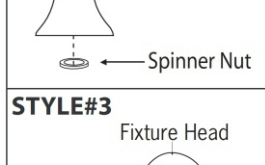
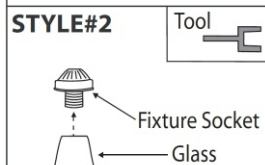
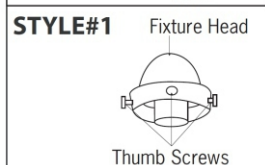
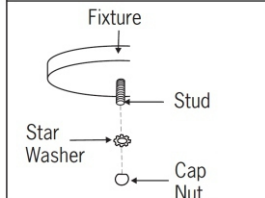
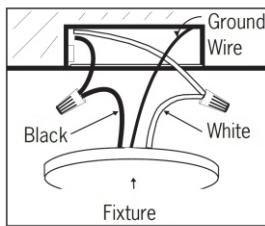

4. Connect the ground wire (bare copper or green) from your fixture to the ground wire (bare copper or green) or ground screw in the electrical outlet box. Connect the black wire (or wire with marketing) from the fixture to the black wire in the electrical box and connect the white wire from the fixture to the white wire in the electrical box.

5. Tuck electrical wires into outlet box and position fixture over studs or nipple on mounting bracket assembly. Secure fixture in place with star washer(s) and cap nut(s).

6. Mounting Glass To Fixture
NOTE: Refer to the style of assembly that matches the style of your fixture.

STYLE #1-Using thumb screws provided, attach the glass to the fixture head. Place the glass into the fixture head and tighten screws into the groove or holes in the glass.

STYLE #2-Remove spinner nut from socket. Position glass on lamp and secure with spinner nut. On some fixtures, a tool is included to attach the spinner nut.

STYLE #3-Squeeze the two clips together around the socket. Slide the glass over the clips, then push the glass up snug to the fixture head.

7. If not already done, install proper bulb type and wattage (not included).

INSTALLATION

1. CAREFULLY PULL CORD [B] THROUGH HOLE IN UPPER BOX AND ADJUST THE CORD LENGTH.
2. CONNECT THE FIXTURE [A] TO THE UPPER BOX BY HOOKING EACH FIXTURE ARM [D1], [D2], [D3] INTO CORRESPONDING EYELETS [C].
3. SCREW THE RODS [E] AND CANOPY [G] TO THE SCREW [F] ON UPPER BOX.
4. ATTACH THE CIRCLE CROSS BAR TO THE OUTLET BOX USING OUTLET BOX SCREWS.
5. PLACE THE CANOPY [G] ONTO THE CIRCLE CROSS BAR, THEN SCREW WITH FINIAL [H].
6. INSTALL BULBS. (BULB INCLUDED)

LL-CH5-26-5BLK / LL-CH5-38-5BLK / LL-CH5-50-5BLK / LL-CH5-1836-5BLK

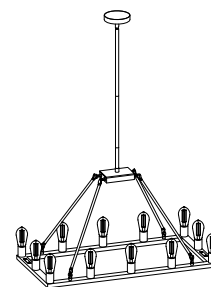

LL-CH5-1836-5BLK

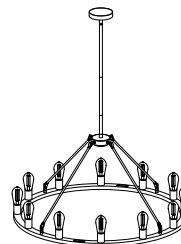

LL-CH5-38-5BLK

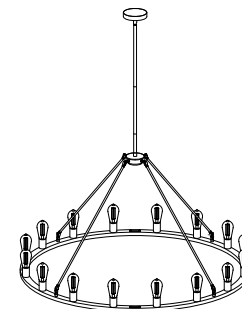

LL-CH5-50-5BLK

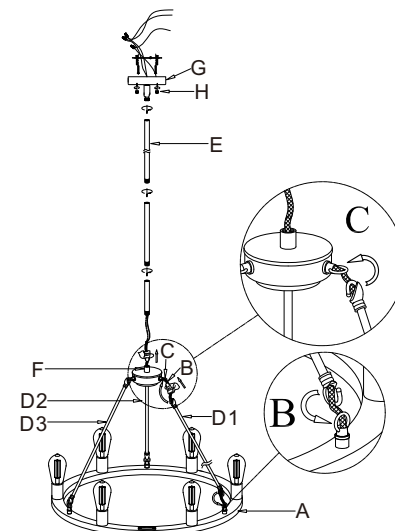

LL-CH5-26-5BLK

CAUTION: PULL ANY EXCESS WIRE THROUGH BOTTOM OF THE LAMP. PLEASE USE TYPE ST19 LED BULB. DO NOT USE LIGHT BULB RATED GREATER THAN 4 WATTS OR THE LAMP MAY BURN AND CAUSE A FIRE! TO CLEAN, USE A SOFT CLOTH ONLY.

NOTE: TURN THE POWER OFF (UNPLUG FROM THE WALL OUTLET) BEFORE REPLACING THE BULB. MAKE SURE THE BULB HAS SUFFICIENT TIME TO COOL DOWN. DO NOT SUBJECT THE LAMP TO ANY SHOCK WHILE LIT AS SHATTERING OF LAMP MAY RESULT.

INSTALLATION INSTRUCTION FOR WALL LAMP

1. PLEASE READ THE INSTRUCTIONS CAREFULLY BEFORE INSTALLATION OF YOUR LIGHTING FIXTURE.
2. REFERRING TO THE DRAWING BELOW, YOU HAVE TO DETERMINE THE TYPE OF FIXTURE WHICH YOU
3. HAVE PURCHASED "SINGLE STRAP MOUNTED" OR "SWIVEL STRAP MOUNTED" AND PROCEED ACCORDINGLY.

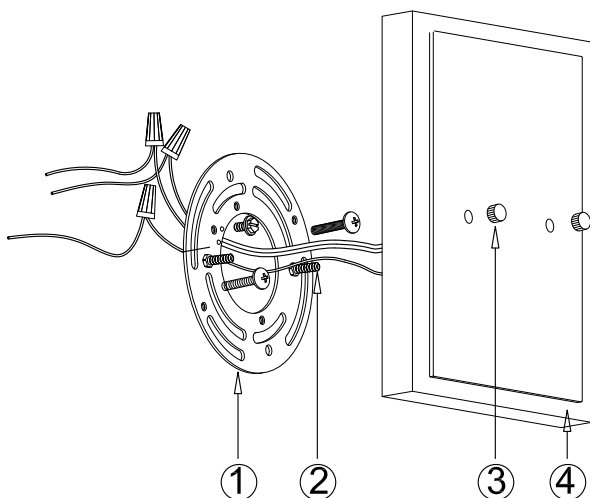

1. CROSS BAR
2. THREADED NIPPLE
3. THREADED CAP
4. BACK PLATE

INSTALLATION PROCEDURES

1. SWITCH OFF THE POWER SUPPLY TO THE OUTLET BOX ON WHICH YOU PLAN TO MOUNT THE LIGHTING FIXTURE (CAUTION DISCONNECT ALL POWER BEFORE SERVJING)
2. FIX THE CROSS BAR TO OUTLET BOX BY USING EXISTING OUTLET BOX SCREWS
3. CONNECT FIXTURE WIRES TO HOUSE WIRES ENSURE THE RIGHT MATCHING AS WHITE, SECURE HOUSE GROUND WIRE TO THE CROSS BAR GROUND WIRE SCREW (CAUTION, MAKE SURE CONNECTIONS ARE SECURED, IN RIGHT POLARITY AND IN GOOD INSULATION)
4. MOUNT LIGHTING FIXTURE ACCORDING TO THE DRAWING ABOVE
5. CAULL WITH SILICON OR SIMILAR CAULKING SUITABLE FOR OUTDOOR USE
6. MAKE A COMPLETE SEAL AROUND FIXTURE CANOPY AND MOUNTING SURFACE

INSTALLATION

1. REMOVE SOCKET RING [D] FROM SOCKET.
2. POSITION GLASS [C] ON LAMP. THEN SECURE WITH SOCKET RING [D].
3. INSTALL BULB [E]. (BULB NOT INCLUDED)

LL-WL20-1SN

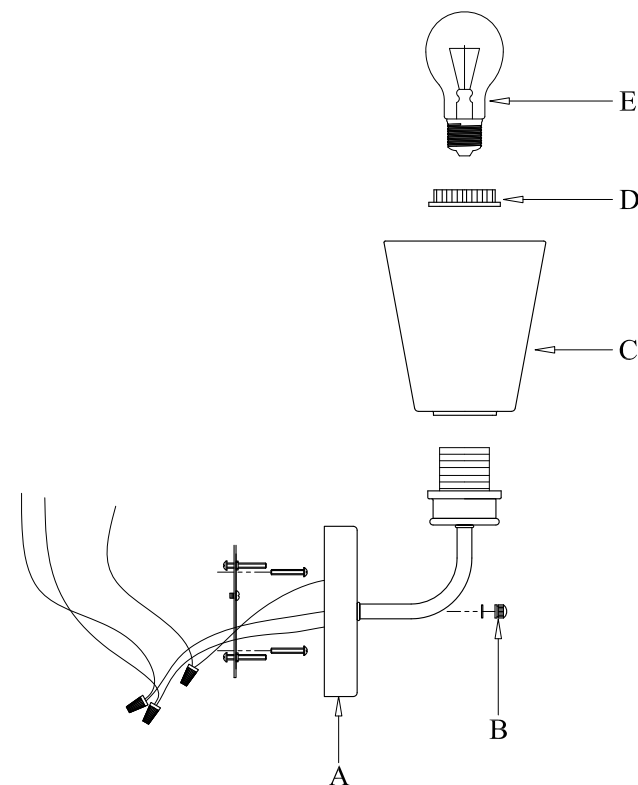

CAUTION: PULL ANY EXCESS WIRE THROUGH BOTTOM OF THE LAMP. PLEASE USE TYPE A BULB. DO NOT USE LIGHT BULB RATED GREATER THAN 60 WATTS OR THE LAMP MAY BURN AND CAUSE A FIRE! TO CLEAN, USE A SOFT CLOTH ONLY.

NOTE: TURN THE POWER OFF (UNPLUG FROM THE WALL OUTLET) BEFORE REPLACING THE BULB. MAKE SURE THE BULB HAS SUFFICIENT TIME TO COOL DOWN. DO NOT SUBJECT THE LAMP TO ANY SHOCK WHILE LIT AS SHATTERING OF LAMP MAY RESULT.