

Thermorail 12V Vertical Towel Rail

Electric Heated Towel Rails for use in bathrooms

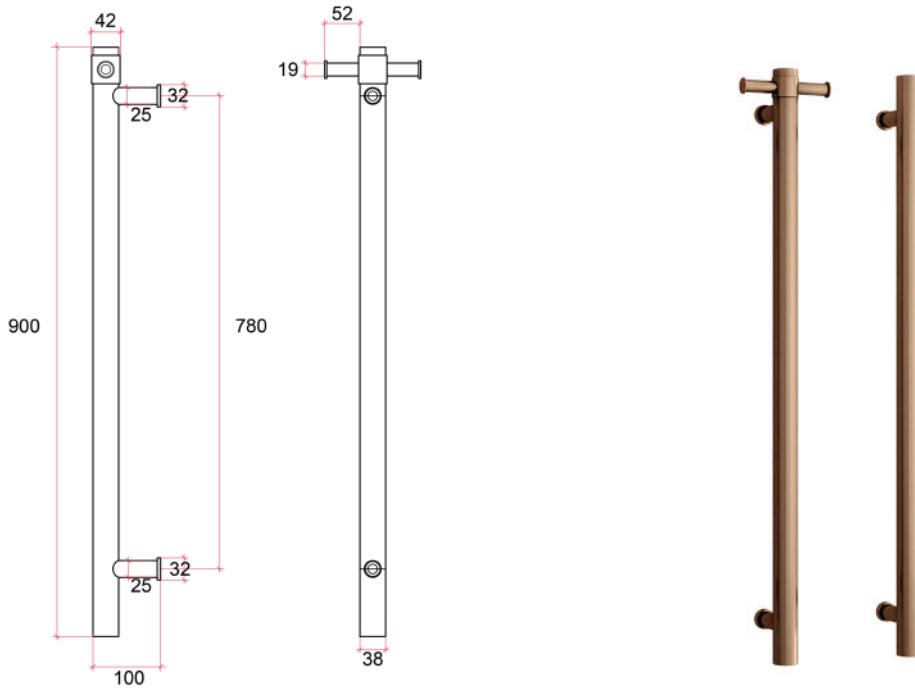

Note: All dimensions are in millimeters (mm)

Rails are sold individually. Hooks are removable.

Stock Code	Finish	Size (mm)	Output (W)	No. of Bars
VS900HBZ	Brushed Bronze	W142 x H900 x D100	22	1



Seven year warranty



Safe for use in bathrooms



Quality stainless steel

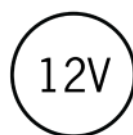

Safe for use in wet areas

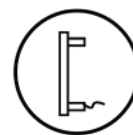

Concealed wiring only

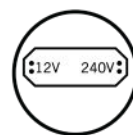

Transformer included
(12 month warranty)

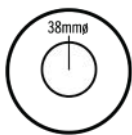

Vertical bar size

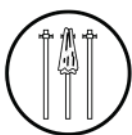

One towel per bar recommended

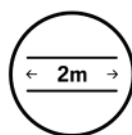

2m lead on rail

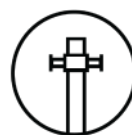

Optional removable hook



PLEASE NOTE: Specifications are for information purposes only. Whilst every effort has been made to ensure the product specifications are accurate, due to continuing product development and improvement the specifications are subject to change. Specifications can be used to rough in and fit timber supports in the wall however we recommend no holes are drilled without having the product on site or verifying the details with the manufacturer. Thermogroup cannot be held liable or responsible for errors due to updated specifications.