



180 Degree Glass To Glass Shower Hinge 10mm Glass



FEATURES

- Glass to glass hinge
- 180 degree glass to glass connection
- Suitable for 10mm glass
- 35kg max door weight per two hinges
- 52.5kg max door weight per three hinges
- 800mm maximum door width
- Hex head machine screws
- Hinges open in & out
- Self closing from approximately 30 degree
- Bevelled profile
- Manufactured from high quality brass

AVAILABLE FINISH

	GUN METAL NRSH102GM		BRUSHED GOLD NRSH102BG
	BRUSHED BRONZE NRSH102BZ		

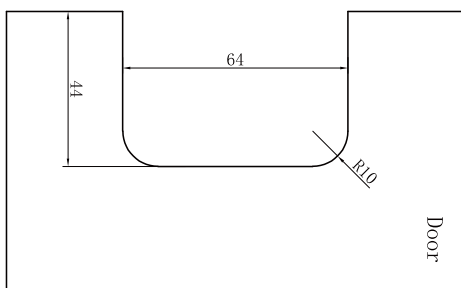
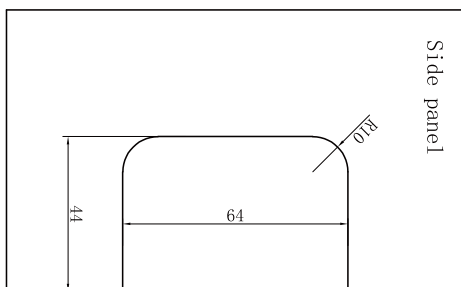

Glass Cutout

MAINTENANCE AND CARE

All surfaces should be cleaned with mild liquid detergent or soap and water.

Do not use cream cleaners or citrus based cleaning products, as they are abrasive.

Use of unsuitable cleaning agents may damage the surface. Any damage caused in this way will not be covered by warranty

Dimension

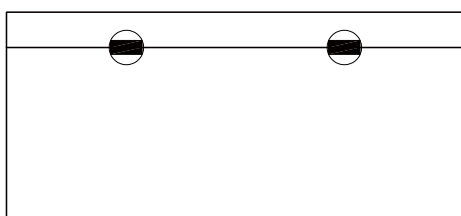
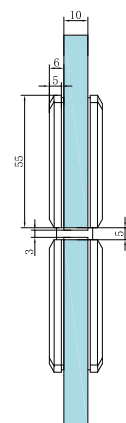
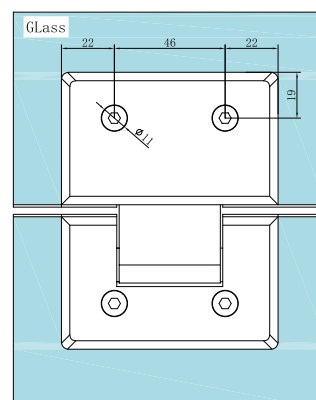

APPLICATION