

REVİZYON / REVISIONS

REV.	AÇIKLAMA / DESCRIPTION	TARİH / DATE	REV. EDEN / REVIZED BY
------	------------------------	--------------	------------------------

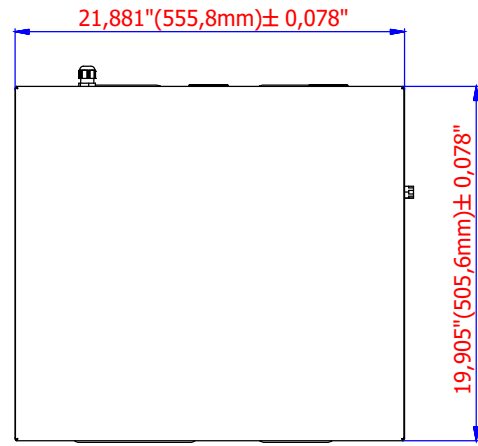

TOP VIEW

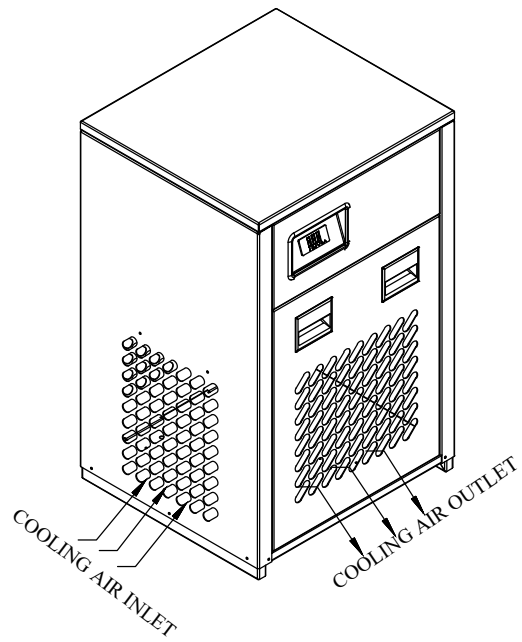
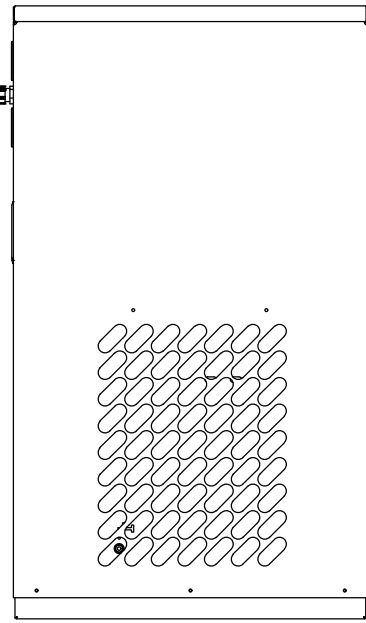

LEFT VIEW

DIGITAL CONTROLLER

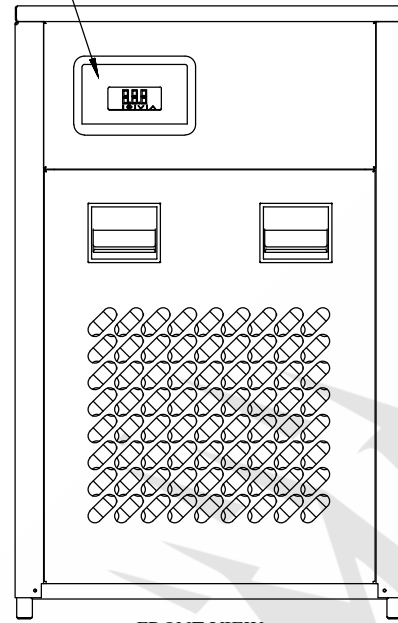

FRONT VIEW

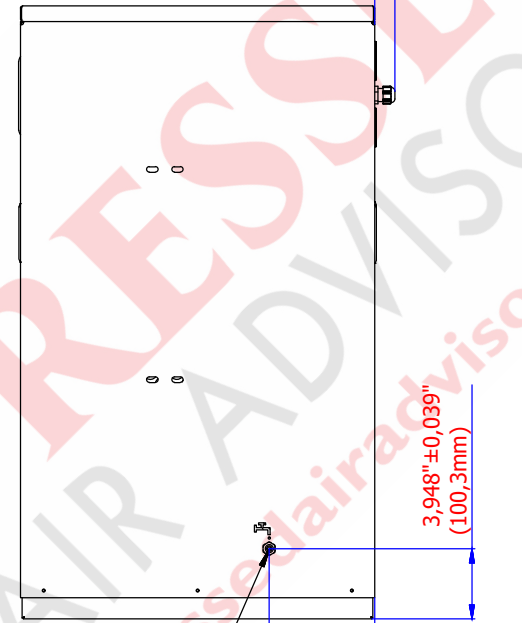

RIGHT VIEW

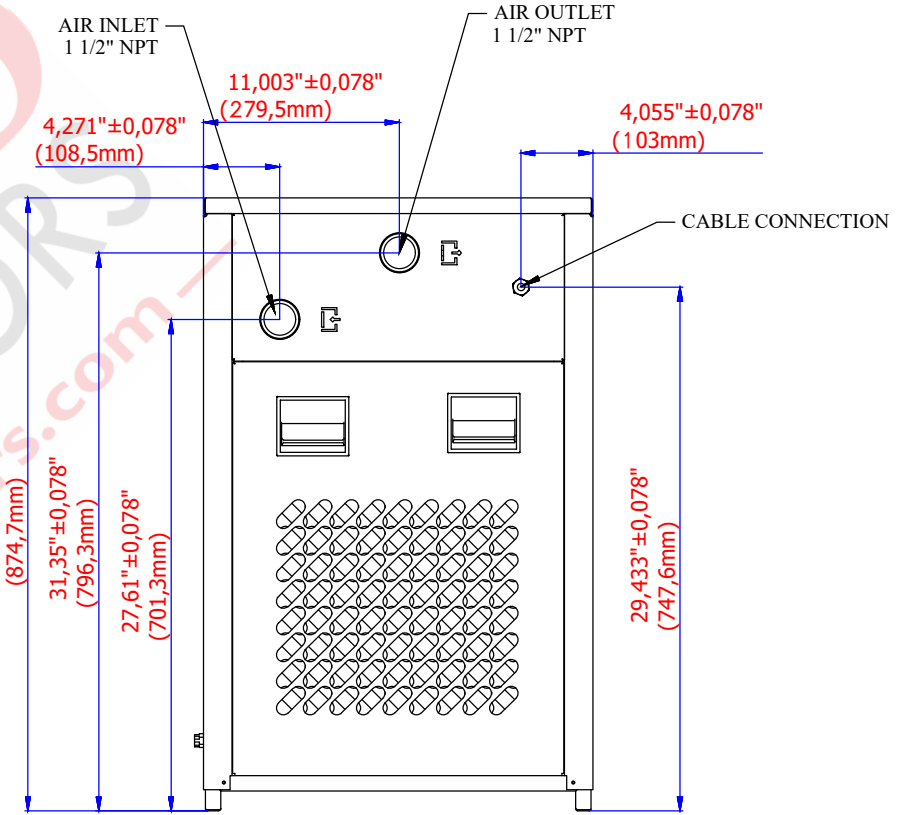

BACK VIEW

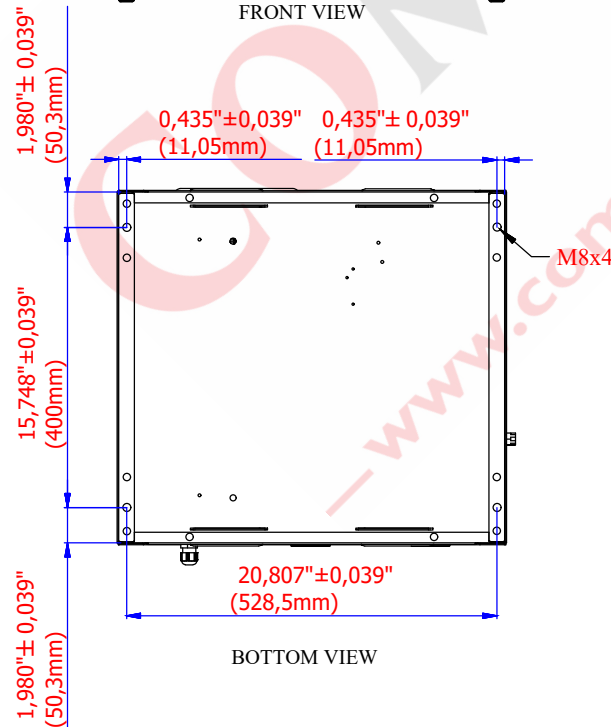

BOTTOM VIEW

UNLESS OTHERWISE SPECIFIED
DIMENSION ARE MILIMETERS
ANDTOLERANCES ON
DIMENSIONS ARE DECIMALS
X:±1.5
XX:±0.5
XXX:±0.25

COMPRESSED
AIR ADVISORS
Inc.

Compressed Air Advisors, Inc.

Phone: 877.247.2381

info@compressedairadvisors.com

www.compressedairadvisors.com

Name	Date	Signature	DRAWING NO	Rev.
Drawn by	M.Refik BÜYÜKOĞLAN	18.07.2019		05
Controlled by	Özden DELİGÖZ	18.07.2019		
Approved by	Burak ÖZTÜRK	18.07.2019		
Scale	1:1	DRYTEC NAME		
		SDE-US-115		
			1011827_ID	0/0