

REVİZYON / REVISIONS

REV.	AÇIKLAMA / DESCRIPTION	TARİH / DATE	REV. EDEN / REVIZED BY
------	------------------------	--------------	------------------------

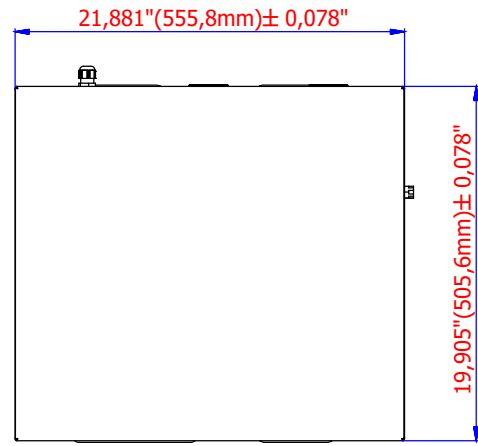

TOP VIEW

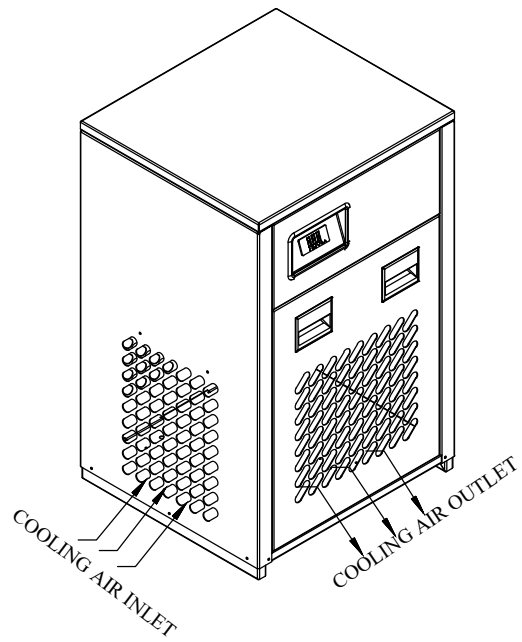
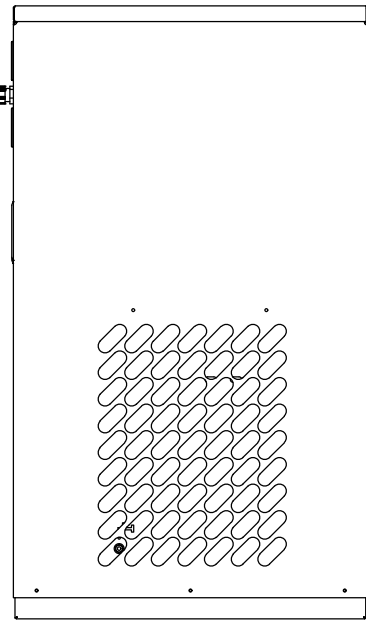

LEFT VIEW

DIGITAL CONTROLLER

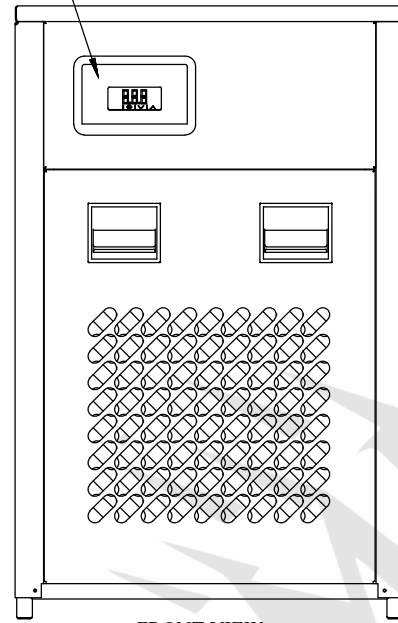

FRONT VIEW

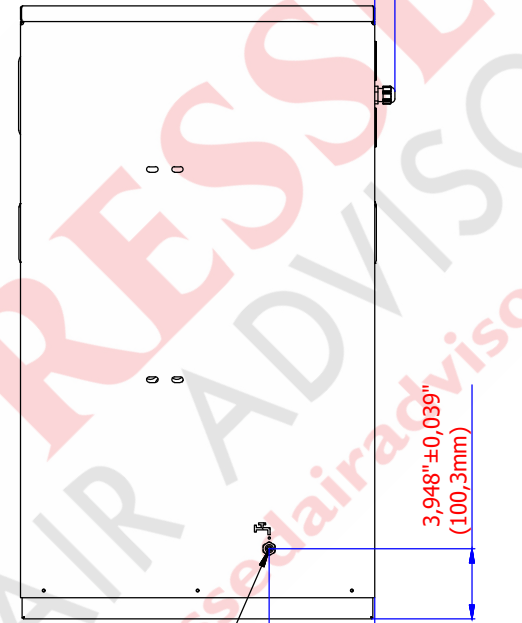

RIGHT VIEW

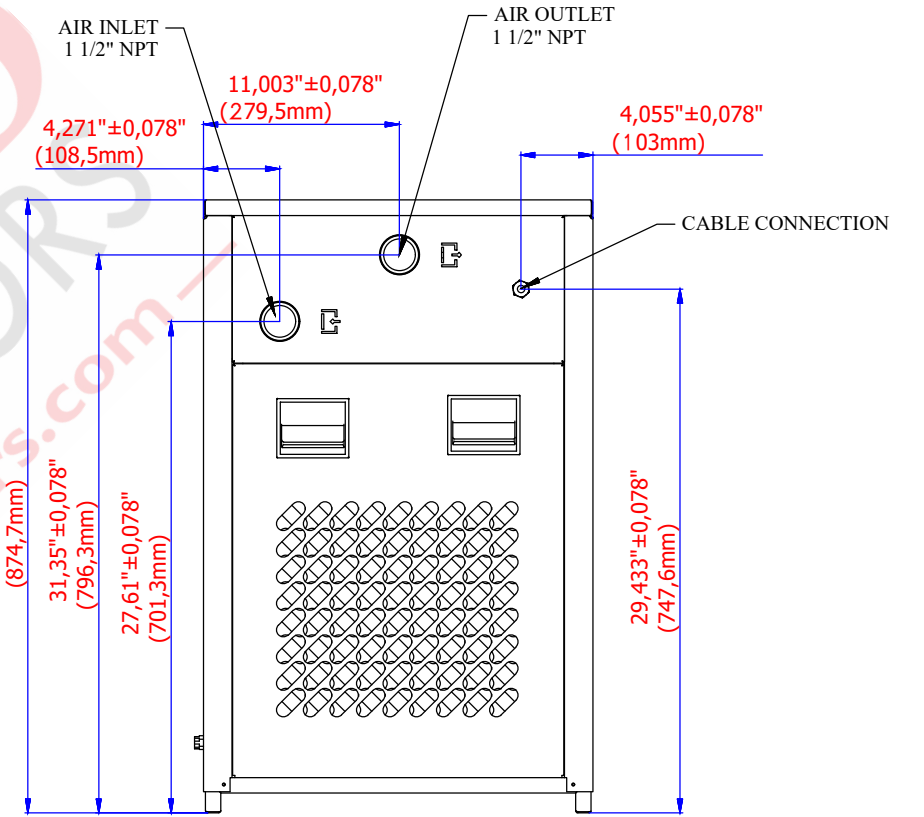

BACK VIEW

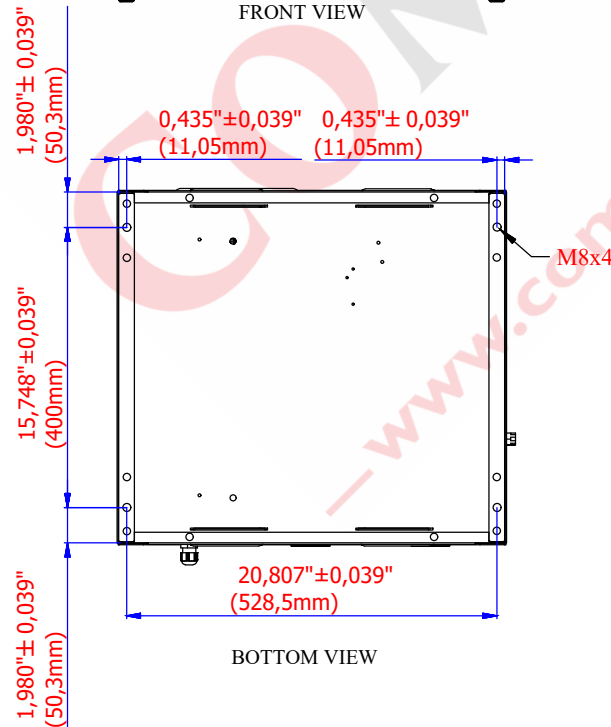

BOTTOM VIEW

UNLESS OTHERWISE SPECIFIED  
DIMENSION ARE MILIMETERS  
AND TOLERANCES ON  
DIMENSIONS ARE DECIMALS  
X:±1.5  
XX:±0.5  
XXX:±0.25

Name	Date	Signature		DRAWING NO	Rev.
Drawn by	M.Refik BÜYÜKOĞLAN	18.07.2019			
Controlled by	Özden DELİGÖZ	18.07.2019			
Approved by	Burak ÖZTÜRK	18.07.2019			
Scale	1:1			1011827_ID	Page
DRYTEC NAME SDE-US-115					0/0