

CHAMPION

R-SERIES

Air Compressors and Units

OPERATION & SERVICE MANUAL **Electric Drive Compressors & Units**

COMPRESSED
AIR ADVISORS
Inc.

Compressed Air Advisors, Inc.

Phone: 877.247.2381

info@compressedairadvisors.com

www.compressedairadvisors.com



R-10/15



R-30



R-40



R-70



WARNING

THIS MANUAL CONTAINS IMPORTANT SAFETY INFORMATION AND SHOULD ALWAYS BE AVAILABLE TO THOSE PERSONNEL OPERATING THIS UNIT. READ, UNDERSTAND AND RETAIN ALL INSTRUCTIONS BEFORE OPERATING THIS EQUIPMENT TO PREVENT INJURY OR EQUIPMENT DAMAGE.

MAINTAIN COMPRESSOR RELIABILITY AND PERFORMANCE WITH GENUINE CHAMPION® COMPRESSOR PARTS AND SUPPORT SERVICES

Champion® Compressor genuine parts, manufactured to design tolerances, are developed for optimum dependability . specifically for Champion compressor systems. Design and material innovations are the result of years of experience with hundreds of different compressor applications. Reliability in materials and quality assurance are incorporated in our genuine replacement parts.

Your authorized Champion Compressor distributor offers all the backup you need. A worldwide network of authorized distributors provides the finest product support in the air compressor industry. Your authorized distributor can support your Champion air compressor with these services:

1. Trained parts specialists to assist you in selecting the correct replacement parts.
2. A full line of factory tested CHAMPLUB® compressor lubricants specifically formulated for use in Champion compressors.
3. Repair and maintenance kits designed with the necessary parts to simplify servicing your compressor.

Authorized distributor service technicians are factory trained and skilled in compressor maintenance and repair. They are ready to respond and assist you by providing fast, expert maintenance and repair services.

To Contact Champion or locate your local distributor:

Visit: www.championpneumatic.com

Or

Call: (888)436-5499

INSTRUCTIONS FOR ORDERING REPAIR PARTS

When ordering parts, specify Compressor MODEL, HORSEPOWER and SERIAL NUMBER (see nameplate on unit). All orders for Parts should be placed with the nearest authorized distributor.

Order by part number and description. Reference numbers are for your convenience only.

Table of Contents

Introduction	4
Safety and Operation Precautions	4
Explanation of Safety Instructions, Symbols, and Decals	6
Safety and Operation Precautions	6
Unit Hazard Decal List – See Page 8	7
Pump Hazard Decal List – See Page 9	7
Unit Hazard Decals	8
Pump Hazard Decals	9
Installation	10
Air Receiver Installation	13
Operation	14
Low Oil Shutdown Control	16
Compressor Oil Specifications	18
Guide to Maintenance	20
Maintenance Checklist	26
Troubleshooting Chart	27
Maintenance Log	29

Introduction

Champion R Series compressors are the result of advanced engineering and skilled manufacturing. To be assured of receiving maximum service from this machine the owner must exercise care in its operation and maintenance. This book is written to give the operator and maintenance department essential information for day-to-day operation, maintenance and adjustment. Careful adherence to these instructions will result in economical operation and minimum downtime.

Standard Warranty R Series Compressor Packages

STANDARD WARRANTY

Champion (the Company) warrants to each original purchaser (Purchaser) of its new products from the Company or its authorized distributor that such products are, at the time of delivery to the Purchaser, free of defects in material and workmanship. **This Standard Warranty statement applies to compressors shipped after April 1st, 2018.**

STANDARD WARRANTY PERIOD

The Company's obligation under this warranty is limited to repairing or, at its option, replacing, during normal business hours at an authorized service facility of the Company, any part which in its judgment proved not to be as warranted within the applicable warranty period as follows. **Regular maintenance in accordance with the service manual is required. Use of genuine Champion OEM parts and lubricants are recommended to maintain warranty. If a component failure is deemed a result of using non-genuine Champion parts and lubricants, warranty will not be allowed.**

COMPONENT	STANDARD WARRANTY COVERAGE	DETAILS
Package	12 months from startup or 18 months from date of shipment from Company, whichever occurs first	All components within the package (ie pressure switch, starter, etc), excluding normal wear items
Pump – Package	24 months from startup or 30 months from date of shipment from Company, whichever occurs first	Applies to pump only, excludes head valves which are warranted for first year only.
Pump – Bare	12 months from startup or 18 months from date of shipment from Company, whichever occurs first	Applies to pumps purchased as bares only
Electric Motors	12 months from startup or 18 months from date of shipment from Company, whichever occurs first	For nonstandard motors, the original manufacturer's warranty will take precedence
Air Receivers	12 months from startup or 18 months from date of shipment from Company, whichever occurs first	Recommended to be installed properly with Company vibration isolators
Labor	<p>Package/Electric Motor/Air Receivers/Bare Pumps: 12 months from startup or 18 months from date of shipment from Company, whichever occurs first</p> <p>Pump (Package): 24 months from startup or 30 months from date of shipment from Company, whichever occurs first</p>	Service will be provided by Company representative or authorized service personnel, for repair or replacement of any product or part which in the Company's sole judgement is proved not to be as warranted. Labor shall be limited to the amount specified in the Company's labor rate schedule. All costs of transportation of product, parts, and repaired or replacement parts claimed not to be as warranted to and from such service facilities shall be borne by the Purchaser. The Company may require the return of any part claimed not to be as warranted to one of its facilities as designated by Company, to establish a claim under this warranty (Return freight eligible for consideration for reimbursement). Replacement Parts provided under the terms of the warranty are warranted for the remainder of the original warranty period.

NO WARRANTY IS MADE WITH RESPECT TO:

1. Any product which has been repaired or altered in such a way, in the Company's sole judgement, as to affect the product adversely
2. Any product which has, in the Company's sole judgement been subject to negligence, accident, improper storage, or improper installation or application
3. Any product which has not been operated or maintained in accordance with the recommendations of the company
4. Any reconditioned or prior owned product
5. Warranty is non-transferable

STANDARD WARRANTY DISCLAIMER

THE FOREGOING WARRANTY IS EXCLUSIVE AND IT IS EXPRESSLY AGREED THAT, EXCEPT AS TO TITLE, THE COMPANY MAKES NO OTHER WARRANTIES AND HEREBY EXPRESSLY DISCLAIMS ALL OTHER WARRANTIES, INCLUDING WITHOUT LIMITATION, EXPRESSED, IMPLIED OR STATUTORY WARRANTIES, INCLUDING ANY IMPLIED WARRANTY OF MERCHANTABILITY OR FITNESS FOR A PARTICULAR USE. THE REMEDY PROVIDED UNDER THIS WARRANTY SHALL BE THE SOLE, EXCLUSIVE AND ONLY REMEDY AVAILABLE TO PURCHASER AND IN NO CASE SHALL THE COMPANY BE SUBJECT TO ANY OTHER OBLIGATIONS OR LIABILITIES. UNDER NO CIRCUMSTANCES SHALL THE COMPANY BE LIABLE FOR SPECIAL, INDIRECT, INCIDENTAL OR CONSEQUENTIAL DAMAGES, EXPENSES, LOSSES OR DELAYS HOWSOEVER CAUSED. NO STATEMENT, REPRESENTATION, AGREEMENT, OR UNDERSTANDING, ORAL OR WRITTEN, MADE BY ANY AGENT, DISTRIBUTOR, REPRESENTATIVE, OR EMPLOYEE OF THE COMPANY WHICH IS NOT CONTAINED IN THIS WARRANTY WILL BE BINDING UPON THE COMPANY UNLESS MADE IN WRITING AND EXECUTED BY AN OFFICER OF THE COMPANY. THIS WARRANTY SHALL NOT BE EFFECTIVE AS TO ANY CLAIM WHICH IS NOT PRESENTED WITHIN 30 DAYS AFTER THE DATE UPON WHICH THE PRODUCT IS CLAIMED NOT TO HAVE BEEN AS WARRANTED. ANY ACTION FOR BREACH OF THIS WARRANTY MUST BE COMMENCED WITHIN ONE YEAR AFTER THE DATE UPON WHICH THE CAUSE OF ACTION OCCURRED. ANY ADJUSTMENT MADE PURSUANT TO THIS WARRANTY SHALL NOT BE CONSTRUED AS AN ADMISSION BY THE COMPANY THAT ANY PRODUCT WAS NOT AS WARRANTED. WARRANTY IS NOT TRANSFERABLE.

Safety and Operation Precautions

Because an air compressor is a piece of machinery with moving and rotating parts, the same precautions should be observed as with any piece of machinery of this type where carelessness in operation or maintenance is hazardous to personnel. In addition to the many obvious safety rules that should be followed with this type of machinery, the additional safety precautions as listed below must be observed:

1. Read all instructions completely before operating air compressor or unit.
2. For installation, follow all local electrical and safety codes, as well as the National Electrical Code (NEC) and the Occupational Safety and Health Act (OSHA).
3. Electric motors must be securely and adequately grounded. This can be accomplished by wiring with a grounded, metal-clad raceway system to the starter; by using a separate ground wire connected to the bare metal of the motor frame or other suitable means.
4. Protect the power cable from coming in contact with sharp objects. Do not kink power cable and never allow the cable to come in contact with oil, grease, hot surfaces, or chemicals.
5. Make certain that the power source conforms to the requirements of your equipment.
6. Pull main electrical disconnect switch and disconnect any separate control lines, if used, before attempting to work or perform maintenance on the air compressor or unit. "Lock out" or "Tag out" all power sources.
7. Do not attempt to remove any compressor parts without first relieving the entire system of pressure.
8. Do not attempt to service any part while machine is in an operational mode.
9. Do not operate the compressor at pressures in excess of its rating.
10. Do not operate compressor at speeds in excess of its rating.
11. Periodically check all safety devices for proper operation. Do not change pressure setting or restrict operation in any way.
12. Be sure no tools, rags, or loose parts are left on the compressor or drive parts.
13. Do not use flammable solvents for cleaning the air inlet filter or element and other parts.
14. Exercise cleanliness during maintenance and when making repairs. Keep dirt away from parts by covering parts and exposed openings with clean cloth or Kraft paper.
15. Do not operate the compressor without guards, shields and screens in place.
16. Do not install a shut-off valve in the discharge line, unless a pressure relief valve, of proper design and size, is installed in the line between the compressor unit and shut-off valve.
17. Do not operate compressor in areas where there is a possibility of ingesting flammable or toxic fumes.
18. Be careful when touching the exterior of a recently run motor - it may be hot enough to be painful or cause injury. With modern motors this condition is normal if operated at rated load - modern motors are built to operate at higher temperatures.
19. Inspect unit daily to observe and correct any unsafe operating conditions found.
20. Do not "play around" with compressed air nor direct air stream at body. This can cause injuries.
21. Compressed air from this machine absolutely must not be used for food processing or breathing air without adequate downstream filters, purifiers and controls.
22. Always use an air pressure regulating device at the point of use. Do not use air pressure greater than marked maximum pressure of attachment.
23. Check hoses for weak or worn condition before each use and make certain that all connections are secure.
24. Always wear safety glasses when using compressed air gun.

The user of any air compressor package manufactured by **Champion** – A Gardner Denver Co., is hereby warned that failure to follow the preceding Safety and Operation Precautions can result in injuries or equipment damage. However, **Champion** – A Gardner Denver Co., does not state as fact or does not mean to imply that the preceding list of Safety and Operating Precautions is all inclusive, and further that the observance of this list will prevent all injuries or equipment damage.

Explanation of Safety Instructions, Symbols, and Decals



Indicates immediate hazards which will result in severe injury or death.



Indicates hazards or unsafe practice which could result in severe injury or death.



Indicates hazards or unsafe practice which could result in damage to the Champion compressor or minor injury.

NOTICE

Notice is used to notify people of installation, operation, or maintenance information which is important but not hazard related.

Safety and Operation Precautions

OBSERVE, UNDERSTAND, AND RETAIN THE INFORMATION GIVEN IN THE SAFETY PRECAUTION DECALS AS SHOWN IN THE DECAL LIST SECTION.



This Oil-Lubricated Compressor must not be used for breathing air without adequate downstream filters, purifiers, and controls. To do so will cause serious injury whether air is supplied direct from the compressor source or to breathing tanks for later use. Any and all liabilities for damage or loss due to injuries, death and/or property damage including consequential damages stemming from the use of this compressor to supply breathing air will be disclaimed by the manufacturer.



The use of this compressor as a booster pump and/or to compress a medium other than atmospheric air is strictly non-approved and can result in equipment damage and/or injury. Non-approved uses will also void warranty.



This unit may be equipped with special options which may not be included in this manual. User must read, understand, and retain all information sent with special options.

Unit Hazard Decal List – See Page 8

PART NO.	DESCRIPTION
P10157A	PRODUCT LIABILITY DECAL SHEET - MASTER
1	Unit Pressure Setting
2	NOT USED
3	DANGER – Breathing Air
4	DANGER – Drain Tank Daily
5	WARNING – Pressure/Safety Valve
6	NOT USED
7	DANGER – Valve Maintenance
8	DANGER – High Voltage
9	WARNING – Hot Surfaces
10	WARNING – Do Not Remove Fan Guard
11a	NOTICE - Lubricant
11b	NOT USED
12	DECAL – Synthetic or Food Grade Inserts
13	NOT USED
14	DECAL – Pressure Setting: 95-125 PSIG
14	DECAL – Pressure Setting: 140-175 PSIG
15	NOTICE – Read and Retain Manuals
16	NOT USED
17	DECAL – Rotation Direction
18	NOT USED
P14677A	DECAL – Pressure Switch

Pump Hazard Decal List – See Page 9

PART NO.	DESCRIPTION
P13805A	PUMP DECAL SHEET – MASTER
A1	NOT USED
A2	NOTICE - Lubricants
B	DECAL – Rotation Direction
C	NOTICE – Read and Retain Manuals
D	DANGER – Breathing Air
E	DECAL – Made in the United States of America
F	IMPORTANT NOTICE – Motor Burn-Outs

P14677A

**DO NOT CONNECT
INCOMING POWER
SUPPLY TO PRESSURE
SWITCH.**

Unit Hazard Decals

1

UNIT PRESSURE FACTORY SET AT

1

UNIT PRESSURE FACTORY SET AT

2



WARNING

DO NOT START ENGINE UNLESS TANK PRESSURE IS BELOW 130 PSIG. TO REDUCE TANK PRESSURE, OPEN VALVE ADJACENT TO THIS DECAL.

3



DANGER

Air from this compressor must not be used for food processing or breathing without adequate filtering. Failure to comply will result in injury or death.

4



DANGER

DRAIN THIS TANK DAILY!
Failure to drain moisture will corrode tank material and lead to tank failure which will cause equipment damage, injury, or death.

5



WARNING

- RELIEVE TANK PRESSURE BEFORE SERVICING. Failure to do so can result in injury.
- DO NOT ADJUST PRESSURE SWITCH, PILOT VALVE, OR SAFETY VALVES. Exceeding factory settings can cause equipment damage and injury.

MODEL: **6**

SERIAL NO:

11a



NOTICE

FOR OPTIMUM PERFORMANCE USE ONLY GENUINE CHAMPION PARTS AND LUBRICANTS. CONTACT LOCAL DISTRIBUTOR FOR ADDITIONAL LUBRICANT AND REPLACEMENT PARTS.

Champion Lubricants

YOUR COMPRESSOR HAS BEEN TESTED AND SHIPPED WITH

11b



NOTICE

FOR OPTIMUM PERFORMANCE USE ONLY GENUINE GARMINER DENVER PARTS AND LUBRICANTS. CONTACT LOCAL DISTRIBUTOR FOR ADDITIONAL LUBRICANT AND REPLACEMENT PARTS.

AFDN

YOUR COMPRESSOR HAS BEEN TESTED AND SHIPPED WITH

12

SYNTHETIC

13

AC-SY AC-FG

14

85-115 PSIG
95-125 PSIG
130-165 PSIG
140-170 PSIG
140-175 PSIG
215-250 PSIG
20-40 PSIG
60-80 PSIG
60-90 PSIG
70-90 PSIG
70-100 PSIG
80-100 PSIG

18

RESET RESET

7



DANGER

Valves must be replaced in original position. Failure to do this will result in equipment damage, injury, or death. Do not disassemble valves.

9



WARNING

Do not touch hot surfaces! Contact with these surfaces can cause injury.

10



WARNING

DO NOT REMOVE BELT OR FAN GUARD. Removal will expose rotating parts which can cause severe injury and/or property damage.

8



DANGER

HIGH VOLTAGE. DISCONNECT POWER SOURCE BEFORE SERVICING.

9



WARNING

Do not touch hot surfaces! Contact with these surfaces can cause injury.

10



WARNING

DO NOT REMOVE BELT OR FAN GUARD. Removal will expose rotating parts which can cause severe injury and/or property damage.

15

NOTICE

Read, understand and retain all labels and Owners Manuals before using this equipment. **IMPORTANT:** Please keep the operating instructions with this compressor unit.

Master Decal Set
P/N P10157A

16

INSTRUCTIONS DUAL CONTROL

This unit is equipped with a dual control valve. Open valve completely for continuous run operation. Close valve completely for start-stop operation.

17

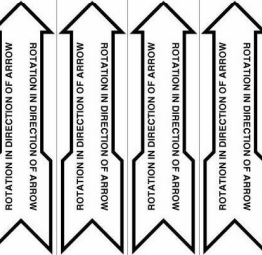

R-Series Electric
Operation & Service

8

CQF3473 v.01
April 17, 2018

Pump Hazard Decals

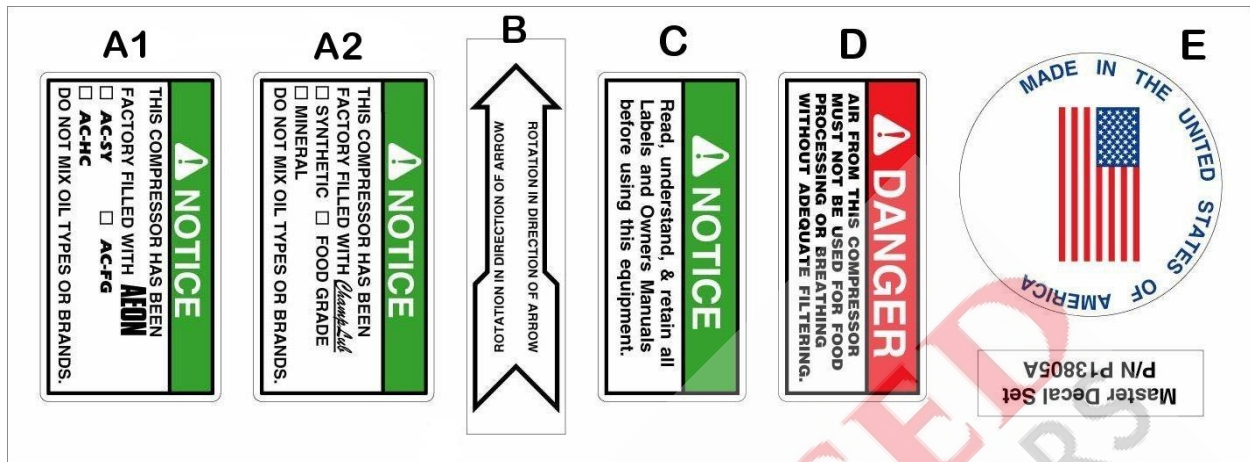

F IMPORTANT NOTICE!

THIS UNIT IS WIRED FOR AN AC CIRCUIT OF

<input type="checkbox"/> 115 VOLT	<input type="checkbox"/> 60 CYCLE	<input type="checkbox"/> 1 PHASE
<input type="checkbox"/> 230 VOLT	<input type="checkbox"/> OTHER	<input type="checkbox"/> 3 PHASE
<input type="checkbox"/> 460 VOLT		

OTHER ELECTRICAL SPECS _____

P05257A

IMPORTANT

MOTOR BURN-OUTS ARE NOT COVERED BY WARRANTY - Unless Motor is Equipped with Factory Installed thermal overload protection (in either motor or starting device)

P05257A

Installation



Do not operate unit if damaged during shipping, handling or use. Operating unit if damaged may result in injury.

1. Permanently installed compressors must be located in a clean, well ventilated dry room so compressor receives adequate supply of fresh, clean, cool, and dry air. It is recommended that a compressor, used for painting, be located in a separate room from that area wherein body sanding and painting is done. Abrasive particles or paint, found to have clogged the air intake filters and intake valves, shall automatically void warranty.
2. Compressors should never be located so close to a wall or other obstruction that flow of air through the fan-bladed flywheel, which cools the compressor, is impeded. Permanently mounted units should be installed so that the belt guard is at least 12" from wall.
3. Place stationary compressors on firm level ground or flooring. Permanent installations are required to be anchored to floor. Bolt holes are provided in the air receiver or base feet. Use shims to level the compressor unit. It is recommended that optional vibration isolator pads be installed with the unit. Tanks anchored directly to a concrete floor without vibration isolator pads will not be warranted against cracking. Champion vibration isolator pads must be used for extended warranty to apply to ASME air receivers. See "Air Receiver Installation" section.



Do not tighten the anchor screws/nuts down completely – this will result in undesirable stress on the tank foot. This can cause abnormal vibration and possible cracking of the air receiver, resulting in injury or equipment damage.

4. If installing a bare pump or a base-mounted unit, make certain the system has adequate pressure limiting controls. Controls could be a pressure switch for start/stop operation or a pilot valve for continuous operation. If a pilot valve is used, the compressor must be equipped with head unloaders. Control air must be piped from the air receiver to the pilot valve.
5. A properly sized air check valve must be installed in the discharge piping, between the compressor outlet and the inlet of any receiver tank(s) in the system.



Do not install isolating valves between compressor outlet and air receiver. This will cause excessive pressure if valve is closed, and cause injury and equipment damage.

Installation (continued)



Always use an air pressure regulating device at the point of use. Failure to do so can result in injury or equipment damage.



- Do not install in an area where ambient temperature is below 32°F or above 104°F.
- Do not install unit in an area where air is dirty and/or chemical laden.
- Unit is not to be installed outdoors.

ELECTRICAL POWER SUPPLY

It is essential that the power supply and the supply wiring are adequately sized and that the voltage corresponds to the unit specifications. Branch circuit protection must be provided at installation as specified in the National Electrical Code.

All wiring should be performed by a licensed electrician or electrical contractor. Wiring must meet applicable codes for area of installation. The table gives recommended wire sizes based on the 2017 NEC.

WIRE SIZE (AWG) - 75°C COPPER - 40°C AMBIENT

MOTOR HP	3 PHASE				1 PHASE		
	200/208V	230V	460V	575V	115V	208V	230V
2	14 (12)	14 (12)	14 (14)	14 (14)	8 (4)	12 (8)	12 (10)
3	12 (10)	14 (10)	14 (14)	14 (14)	6 (3)	10 (6)	10 (8)
5	10 (6)	12 (8)	14 (12)	14 (12)	--	8 (4)	8 (4)
7-1/2	8 (4)	10 (6)	14 (10)	14 (10)	--	4 (1)	6 (2)
10	8 (3)	8 (4)	12 (8)	14 (10)	--	--	--
15	4 (1)	6 (2)	10 (6)	10 (6)	--	--	--
20	3 (00)	4 (0)	8 (4)	10 (6)	--	--	--
25	1 (0000)	2 (000)	6 (3)	8 (4)	--	--	--
30	0 (250)	1 (0000)	6 (2)	8 (4)	--	--	--

Values in () for Duplex Unit w/one incoming power line to both motors.

All models require a properly sized magnetic starter as specified in the National Electric Code (NEC). See Control Panel Manual for details.

If ordered with a factory mounted control panel, compressor is wired at factory. It is necessary only to bring lines from a properly sized disconnect switch to the control panel mounted on the unit.

Installation (continued)



Wiring must be such that when viewing compressor from opposite shaft end, rotation of shaft is clockwise as shown by arrow on guard. Wrong direction rotation for any length of time will result in damage to compressor.

GROUNDING INSTRUCTIONS

This product should be connected to a grounded, metallic, permanent wiring system, or an equipment-grounding terminal or lead on the product.

AIR LINE PIPING

Connection to air system should be of the same size, or larger, than discharge pipe out of unit. The table gives recommended minimum pipe sizes. A union connection to the unit and water drop leg is recommended. Install a flexible connector between the discharge of the unit and the plant air piping. Plant air piping should be periodically inspected for leaks using a soap and water solution for detection on all pipe joints. Air leaks waste energy and are expensive.

Minimum Pipe Sizes For Compressor Air Lines
(Based on clean Smooth Schedule 40 Pipe)

MODEL	25'	50'	100'	200'	300'
R10D	3/4" (1")	3/4" (1")	3/4" (1")	3/4" (1")	3/4" (1")
R15B	3/4" (1")	3/4" (1")	3/4" (1")	1" (1-1/4")	1" (1-1/4")
R30D	3/4" (1-1/4")	1" (1-1/4")	1" (1-1/4")	1" (1-1/2")	1" (1-1/2")
R40A	1-1/4" (1-1/2")	1-1/4" (1-1/2")	1-1/4" (1-1/2")	1-1/4" (1-1/2")	1-1/4" (1-1/2")
R70A	1-1/4" (1-1/2")	1-1/4" (1-1/2")	1-1/4" (1-1/2")	1-1/2" (2")	1-1/2" (2")

Values in () are for duplex unit.



Never use plastic pipe or improperly rated metal pipe. Improper piping material can burst and cause injury or property damage.

Air Receiver Installation

Vibration isolator pads can be purchased from your local authorized distributor. Installation hardware items (studs, screws, nuts, shims) are not provided. It is the compressor owner's responsibility to provide a suitable foundation and isolator installation.



Do not tighten the anchor screws/nuts down completely – this will result in undesirable stress on the tank foot. This can cause abnormal vibration and possible cracking of the air receiver, resulting in injury or equipment damage.

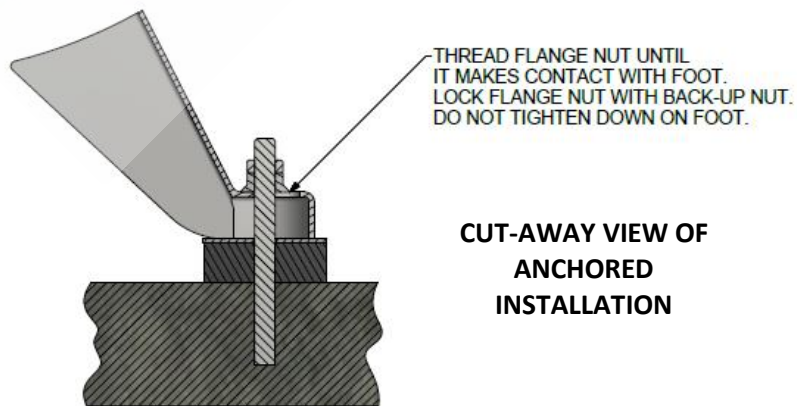
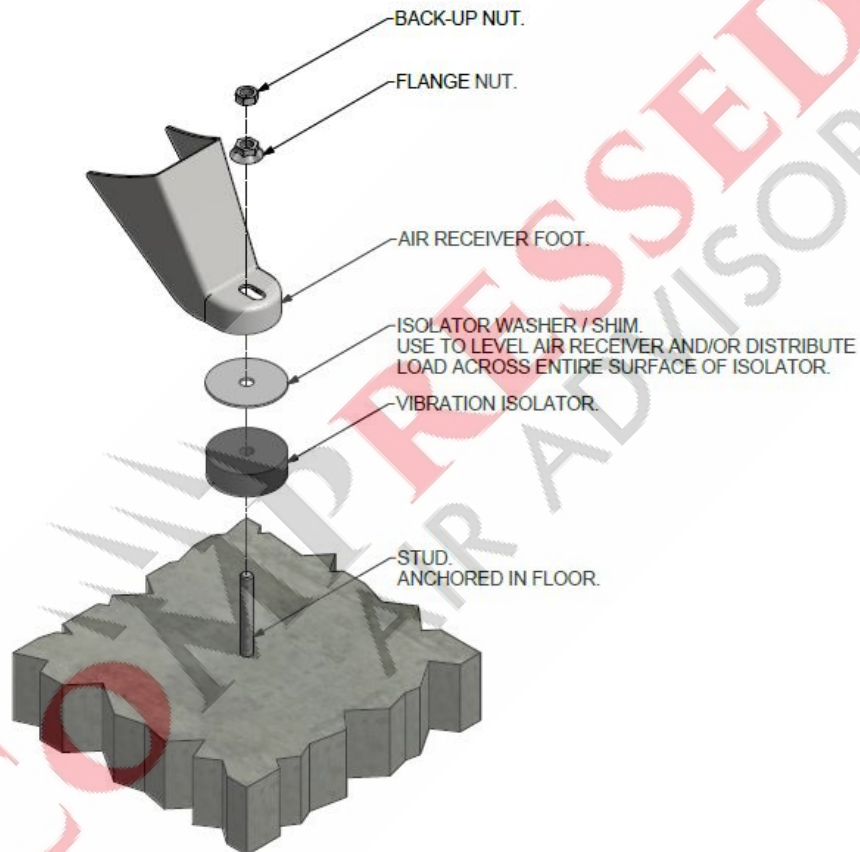

CUT-AWAY VIEW OF ANCHORED INSTALLATION

TEN011442-00
(Ref. Drawing)

Operation

This compressor has been inspected, thoroughly tested and approved at the factory. For this unit to give long satisfactory service it must be installed and operated properly. This compressor has been designed for an 80%/ON – 20%/OFF duty cycle.

SIMPLEX UNITS have a pressure switch that senses changes in receiver pressure and automatically starts and stops the compressor at preset pressure limits. If the receiver pressure falls below the cut-in pressure setting of the pressure switch the compressor will run until the cut-out pressure setting of the pressure switch has been reached.

DUPLEX UNITS have lead (PS1) and lag (PS2) pressure switches and an automatic alternating system to evenly distribute the load between the two compressors. The pressure switches sense changes in receiver pressure and automatically start and stop the compressor at preset pressure levels. If the receiver pressure falls below the cut-in pressure setting of the lead (PS1) pressure switch but remains above the cut-in pressure setting of the lag (PS2) pressure switch, only one compressor will run until receiver pressure reaches the cut-out pressure of the lead (PS1) pressure switch. The next time the pressure in the receiver drops, the system automatically starts the compressor that was idle. If the receiver pressure falls below the cut-in pressure setting of the lag (PS2) pressure switch, both compressors run until receiver pressure reaches the cut-out pressure setting of the lead (PS1) pressure switch.

CONTINUOUS RUN units are equipped with a ball valve, pilot valve and head unloaders to provide continuous run capabilities. The pilot valve acts as an automatic air switch allowing air to flow from the receiver to the head unloader mechanism, thus actuating it. To operate unit in continuous run, open ball valve located next to pilot valve. The pilot valve is now able to sense receiver pressure. When the receiver pressure reaches the cut-out pressure setting of the pilot valve, the pilot valve opens and air is released to the unloader mechanism. The compressor stops compressing air and runs unloaded until the cut-in pressure setting of the pilot valve has been reached. At this time air released from the unloader mechanism and the compressor starts compressing again. Continuous run is recommended if motor starts exceed 8 starts/hour.

INITIAL START UP – ELECTRIC MOTOR UNITS

1. Inspect unit for any visible signs of damage that would have occurred in shipment or during installation.
2. Pull main disconnect switch to unit to assure that no power is coming into the unit. “Lock Out” or “Tag Out” switch. Connect power leads to start.



Do not attempt to operate compressor on voltage other than that specified on order or on compressor motor and control panel. Voltage conversion kits are available if alternate operating voltage is required.

Operation (continued)

3. Check compressor oil level. Add oil as required. See “Compressor Oil Specifications” Section.
NOTE: Do not mix oil type, weights, or brands.
4. Activate main disconnect switch.
5. “Jog” motor and check for proper rotation by direction arrow. If rotation is wrong, reverse input connections on the magnetic starter.
6. Close receiver discharge ball valve and start the compressor.
7. With receiver ball valve closed, let the machine pump up to operating pressure.
8. Check for proper operation of the pressure switch.
 - a. When the air receiver pressure reaches the cut-out setting of the pressure switch, the machine will stop.
 - b. Open the receiver ball valve slowly, allowing pressure in the receiver to drop.
 - c. When the air receiver pressure drops to the cut-in setting of the pressure switch, the machine will start.
 - d. Repeat steps a. thru c. three times.
9. Check for proper operation of the head unloaders (if equipped).
 - a. Open the ball valve located next to the pilot valve.
 - b. When the air receiver pressure reaches the cut-in setting of the pilot valve, the head unloaders will activate. The air compressor continues to run, but air compression is stopped.
 - c. Open the receiver ball valve slowly, allowing pressure in the receiver to drop.
 - d. When the air receiver pressure drops to the cut-out setting of the pilot valve, the head unloaders will de-activate. Air compression will resume.
 - e. Repeat steps b. thru d. three times.
10. Check for proper operation of any options.
11. When the initial run period has shown no operating problems, shut unit down and recheck oil level.
12. Open receiver ball valve. The air compressor unit is now ready for use.



This unit can start automatically without warning.

Low Oil Shutdown Control

(optional equipment)

The oil monitor must be used in conjunction with a magnetic starter (see wiring diagram for details). The oil monitor is installed on the outside of the air compressor crankcase with a port that allows oil to feed into it's float bowl chamber and maintain the same level as in the crankcase. The float moves vertically up or down as the oil level changes. If the oil level is below minimum allowable operating level, the reed switch will open, thus stopping the motor. A magnet holds the float and prevents the compressor from starting. In order to start the compressor the following steps must be taken:

1. Fill crankcase to recommended capacity as indicated when level reaches the middle of the oil sight glass.
2. Turn cam reset knob 90° clockwise.

IMPORTANT NOTE: The Oil Monitor does not eliminate the compressor owner's responsibility for periodically checking oil level. Refer to maintenance instructions.

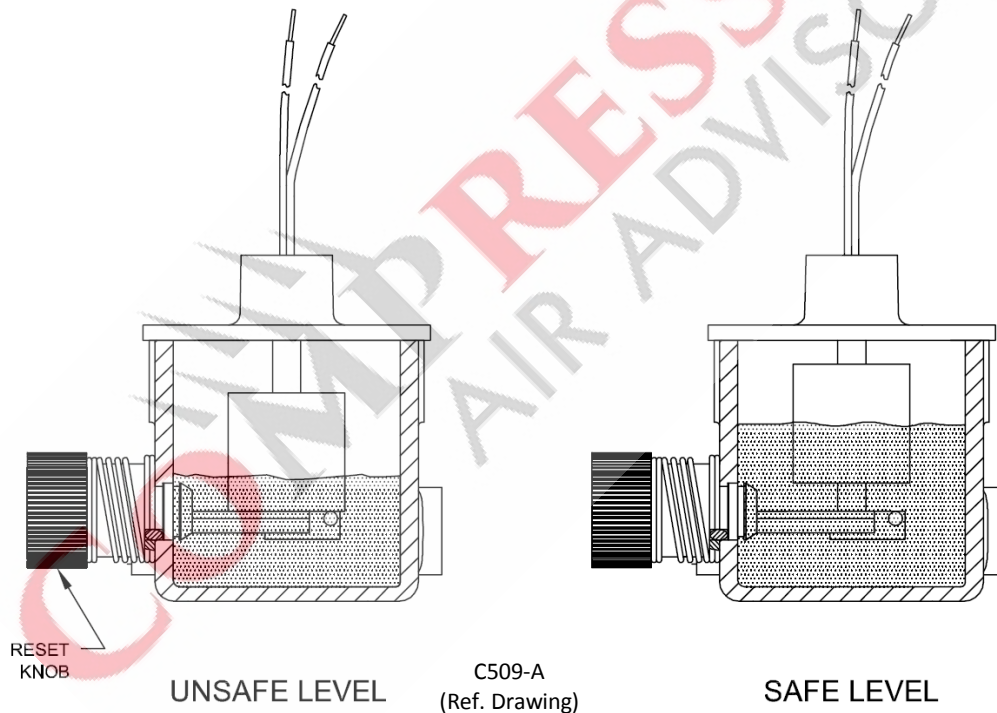

WIRING DIAGRAM: The oil monitor is wired into the control panel as shown below. Refer to the Control Panel User Manual for complete wiring diagrams.

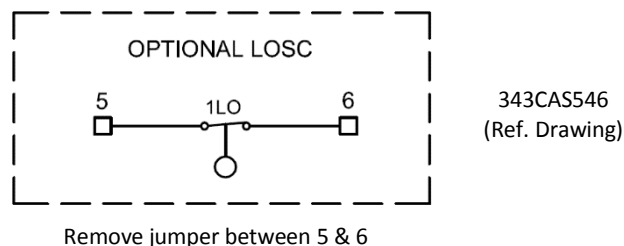

Low Oil Shutdown Control (continued)

(optional equipment)

TROUBLESHOOTING & SERVICING



Always disconnect unit from power supply and relieve all pressure from air tank before performing any maintenance. “Lock Out” or “Tag Out” all power sources. Failure to do so may result in personal injury or death.

NOTICE

Do not disassemble LOSC switch. Disassembly will void warranty.

No adjustments are required for the oil monitor.

If the oil monitor does not operate properly, check the items listed below to determine the cause.

1. Crankcase Oil

- a. Check sight glass to insure proper oil level in crankcase, when compressor is shut off.
- b. Check crankcase oil for proper viscosity. This is particularly important for temperature conditions below 32°F. Oil which is too thick can slow the response of the mechanism, causing float to register a low level.
- c. Change oil regularly. Clean oil insures proper operation of the Oil Monitor, as well as compressor. See Compressor Oil Specification and Maintenance sections for details.

2. Vent Tube

- a. Check vent tube to insure it is not clogged.
- b. Check the gasket between valve body and bowl for leaks. This will cause a pressure rise in the crankcase which will give a false safe oil level indication.
- c. Check the fittings at ends of vent tube for tightness and leaks.

3. Reset

- a. Check that reset return spring is in proper working order.
- b. Verify that reset knob is in fully counterclockwise position.

Compressor Oil Specifications

Compressors are factory filled with CHAMPLUB hydrocarbon-based recip lubricant. This is an ISO 100 non-detergent industrial lubricant with rust and oxidation inhibitors specially formulated for reciprocating compressors. It is recommended this compressor be maintained using this oil for ambient temperatures above 32°F.

CHAMPLUB synthetic is a premium grade diester based synthetic lubricant providing excellent performance in high temperature applications.

Do not mix oil types, weights or brands.

Emulsification of oil (white milky substance) indicates unsafe accumulation of moisture and may be evidence compressor is oversized for application. Failure to promptly consult your local distributor, or Champion Customer Service, can be grounds to deny warranty.

LUBRICANT - ISO 100 MINERAL

CHAMPLUB ISO 100

DESCRIPTION	PART NUMBER
1 – Quart Case (12/case)	P09479A
1 – Gallon Case (4/case)	P08909A
5 – Gallon Pail	P08908A
55 – Gallon Drum	P08907A

LUBRICANT - SYNTHETIC DIESTER

CHAMPLUB SYNTHETIC

DESCRIPTION	PART NUMBER
1 – Quart Case (12/case)	P13179A
1 – Gallon Case (4/case)	P13180A
5 – Gallon Pail	P11506A
55 – Gallon Drum	P13181A

Compressor Oil Specifications (continued)

LUBRICANT LEVEL:

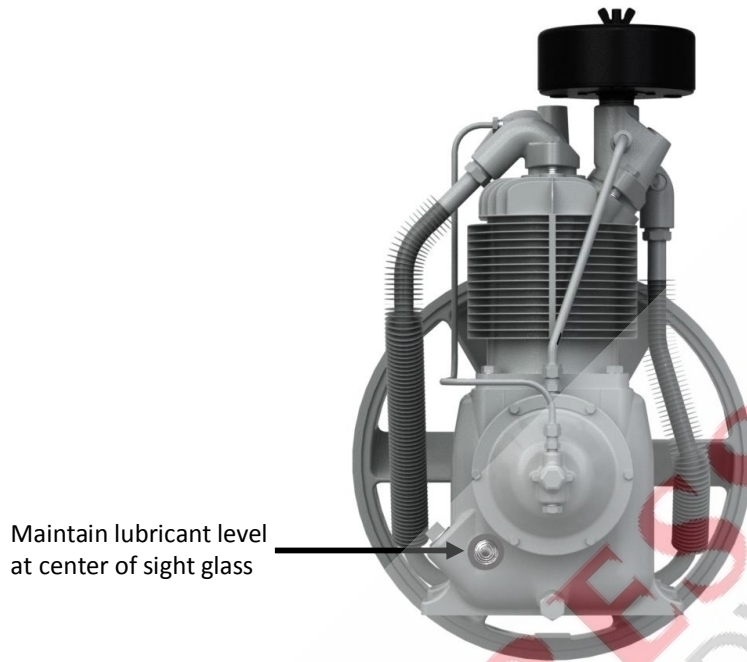

BREAK-IN PERIOD: 100 hours of operation or 3 months, whichever comes first.

1. Compressor must run for the break-in period using CHAMPLUB ISO 100 lubricant.
2. During the break-in period, a careful and regular check of the oil level should be made. Maintain oil level at the full line.
3. After the break-in period, thoroughly drain existing oil from crankcase.
4. Add a full charge of CHAMPLUB ISO 100 lubricant.

CHANGING TO SYNTHETIC DIESTER BASED LUBRICANT

If changing to synthetic lubricant, the following steps must be completed.

1. Compressor must run for the break-in period using CHAMPLUB ISO 100 lubricant.
2. During the break-in period, a careful and regular check of the oil level should be made. Maintain oil level at the full line.
3. After the break-in period, thoroughly drain existing oil from crankcase.
4. Add a full charge of CHAMPLUB SYNTHETIC lubricant.
5. Run compressor for 200 hours.
6. Stop compressor and thoroughly drain the synthetic lubricant.
7. Add a full charge of CHAMPLUB SYNTHETIC lubricant.
8. Compressor is now ready to run for extended period before next lubricant change. Maintain oil level at the full line.

Guide to Maintenance

To obtain reliable and satisfactory service, this unit requires a consistent preventive maintenance schedule. Maintenance schedule pages are included in the back of this manual to aid in keeping the proper records.



Before performing any maintenance function, switch main disconnect switch to "off" position to assure no power is entering unit. "Lock Out" or "Tag Out" all sources of power. Be sure all air pressure in unit is relieved. Failure to do this may result in injury or equipment damage.



Do not exceed 15 PSIG nozzle pressure when cleaning element parts with compressed air. Do not direct compressed air against human skin. Serious injury could result. Never wash elements in fuel oil, gasoline or flammable solvent.



Never operate unit without belt guard in place. Removal will expose rotating parts which can cause injury or equipment damage.



Valves must be reinstalled in original position. Valve gaskets should be replaced each time valves are serviced.

PRESSURE RELIEF VALVE: The pressure relief valve is an automatic pop valve. Each valve is properly adjusted for the maximum pressure permitted by tank specifications and working pressure of the unit on which it is installed. If it should pop, it will be necessary to drain all the air out of the tank in order to reseal properly. Do not adjust.

TANK DRAIN VALVE: Drain valve is located at bottom of tank. Open drain valve daily to drain condensation. Do not open drain valve if tank pressure exceeds 25 PSIG. The electric tank drain-equipped compressor requires draining manually once a week.

PRESSURE SWITCH: The pressure switch is automatic and will start compressor at low pressure and stop when the maximum pressure is reached. It is adjusted to start and stop compressor at the proper pressure for the unit on which it is installed. Only a certified field service technician should make adjustments to the pressure switch.

Guide to Maintenance (continued)

PILOT VALVE: The pilot valve actuates the head unloader mechanism to provide a means of stopping or starting the compression of air by the compressor without stopping or starting the engine.



The pilot valve is pre-set from the factory, according to the order specification. Only a certified field service technician should make adjustments to the pilot valve.

PILOT VALVE PRESSURE ADJUSTMENT

Proceed with the following instructions while compressor is running:

1. Loosen locknut (4) and back off several turns. Do not turn differential pressure adjustment nut (3).
2. Check reading on the tank pressure gauge. Set the compressor maximum pressure by turning threaded cap (1) clockwise to increase pressure or counter clockwise to decrease pressure.
3. After pressure is set, tighten locknut (4). Be careful not to move threaded cap (1).

PILOT VALVE DIFFERENTIAL PRESSURE ADJUSTMENT

Proceed with the following instructions while compressor is running:

1. Loosen locknut (2) and back off several turns.
2. Check reading on the tank pressure gauge. Set the pressure to 30 psig differential (unload at 170 psig, reload at 140 psig). Turn nut (3) clockwise to increase differential pressure or counterclockwise to decrease differential pressure.
3. After pressure is set, tighten locknut (2). Be careful not to move nut (3).

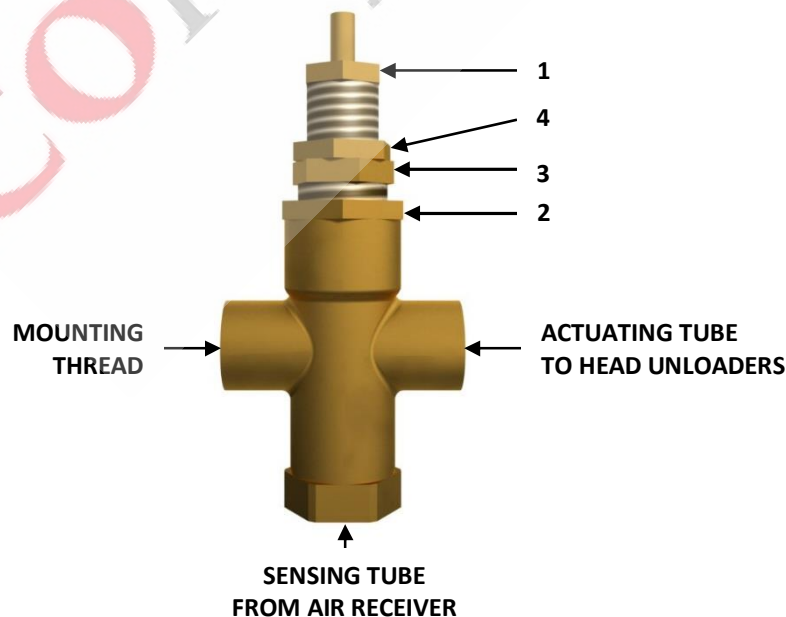

Guide to Maintenance (continued)

COMPRESSOR VALVES: If compressor fails to pump air or seems slow in filling up tank, disconnect unit from power source and remove valves and clean thoroughly, using compressed air and a soft wire brush. After cleaning, exceptional care must be taken that all parts are replaced in exactly the same position. All joints must be tight or the compressor will not function properly. When all valves are replaced and connections are tight, close ball valve at tank outlet for final test. Valve gaskets should be replaced each time valves are removed from pump.

CENTRIFUGAL UNLOADER AND UNLOADER PRESSURE RELEASE VALVE: The centrifugal unloader is operated by two governor weights. It is totally enclosed and lubricated from the crankcase of the compressor. When compressor starts, the governor weights automatically open, compressing the main spring, allowing the unloader pressure release valve to close. When the compressor stops, the main spring returns the governor weights to normal position, opening the unloader pressure release valve and unloading the compressor. This prevents overloading the motor when starting. If air continues to escape through the governor or unloader pressure release valve while operating, this is an indication that the unloader pressure release valve is not closing tightly and may be held open by a foreign substance which has lodged against the seat. In order to correct this, remove the governor release valve cap, allowing access to unloader pressure release valve spring and ball. Clean thoroughly and return parts in the same order in which they were removed. See Centrifugal Unloader section in parts list for diagram. Loose drive belts can also cause unloader to leak by preventing the compressor from reaching proper speed. (See "BELTS" page 24).

CHECK VALVE: The check valve closes when the compressor stops operating, preventing air from flowing out of the tank through the pressure release valve. After the compressor stops operating, if air continues to escape through the release valve, it is an indication that the check valve is leaking. This can be corrected by removing check valve and cleaning disc and seat. If check valve is worn badly, replace it.



Before removing check valve, be sure all air is drained out of tank and power is disconnected. Failure to do so may result in injury or equipment damage.

THE INTERSTAGE PRESSURE RELIEF VALVE is provided to protect against interstage over pressure and is factory set for maximum pressure of 75 PSIG. **DO NOT RESET.** If the pressure relief valve pops, it indicates trouble. Shut down the unit immediately and determine and correct the malfunction. Inspect the head valves. Serious damage can result if not corrected and can lead to complete destruction of the unit. Tampering with the interstage pressure relief valve or plugging the opening destroys the protection provided and voids all warranty.

COMPRESSOR LUBRICATION: Fill crankcase to proper level as indicated by oil sight gauge. Keep crankcase filled as required by usage. It is recommended that only Champlub recip lubricant be used. This is an ISO 100, non-detergent industrial oil with rust and oxidation inhibitors specially formulated for reciprocating compressors. Do not mix oil types, weights, or brands.

Guide to Maintenance (continued)

MOTOR LUBRICATION: Long life satisfactory operation of an electric motor depends in large measure on proper lubrication of the bearings. Bearing grease will lose its lubricating ability overtime, not suddenly. Refer to the motor manufacturer's instructions for the type of grease and lubrication intervals.

TORQUE VALUES:

Component	Fastener Size & Thread	Model	Torque
Governor Housing	3/8-16	R10, R15	400 Inch-lb.
Governor Housing	7/16-20	R30, R40, R70	550 Inch-lb.
Cylinder Flange	7/16-20	R10, R15, R30	400 Inch-lb.
Cylinder Flange	1/2-13	R40, R70	900 Inch-lb.
Governor Spindle Screw	7/16-20	R10, R15, R30, R40, R70	470 Inch-lb.
Rod Bolt	5/16-18	R10, R15, R30	230 Inch-lb.
Rod Bolt	7/16-20	R40, R70	400 Inch-lb.
Manifold Cap Screw	3/8-16	R10, R15, R30	200 Inch-lb.
Manifold Cap Screw	7/16-14	R40, R70	230 Inch-lb.
Flywheel Pinch Bolt	1/2-13	R10, R15, R30	600 Inch-lb.
Flywheel Cap Screw	7/16-20	R40, R70	600 Inch-lb.

Guide to Maintenance (continued)

SETTING BELT TENSION

1. Proper setting of the belt tension requires a belt tension checker (part number TEN011452).
2. Measure the belt span.
3. On the belt tension checker, position the o-ring on the span scale at the measured belt span.
4. Position the o-ring on the deflection force scale to zero.
5. Place a straight edge across the outside diameters of the motor pulley and compressor flywheel.
6. Place the tension checker squarely on one belt at the center of the belt span. Apply a force on the plunger, perpendicular to the belt span until the bottom of the large o-ring is even with the bottom of the straight edge.
7. Remove the tension checker and read the force applied from the bottom of the small o-ring on the deflection force scale.
8. Compare the force you have applied with the values given in the table on page 25. The force should be between the minimum (used belt) and maximum (new belt) shown.
9. Make adjustments to the location of the motor to achieve proper tension.

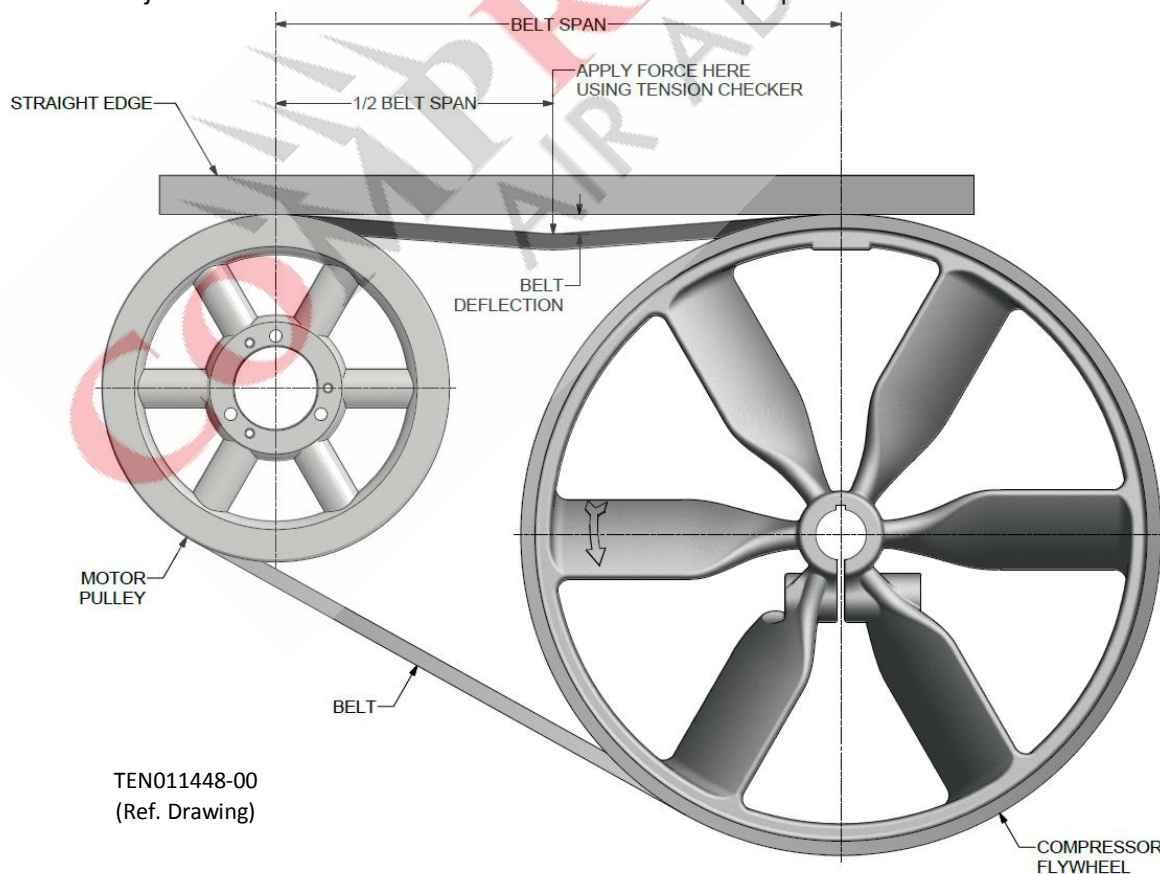

Guide to Maintenance (continued)

BELT DEFLECTION FORCE

MODEL	H.P.	PSI	RPM	MOTOR PULLEY O.D.	BELT SECTION	BELT NUMBER	QTY OF BELTS	USED BELT DEFLECTION FORCE (lbs. min)	NEW BELT DEFLECTION FORCE (lbs. max)
R10	2	125	503	5.15	A	62	1	3.4	4.9
R10	2	175	411	4.35	AX	61	1	4.1	6.0
R10	3	125	800	7.75	A	64	1	3.2	4.6
R10	3	175	754	7.35	A	64	1	3.4	4.9
R15	5	125	780	7.35	B	65	1	5.3	7.7
R15	5	175	736	6.95	B	65	1	5.6	8.1
R15	7.5	125/175	959	8.95	B	67	1	6.3	9.2
R30	7.5	125	646	7.00	B	80	2	4.3	6.2
R30	7.5	175	568	6.20	B	79	2	4.8	6.9
R30	10	125	777	8.35	B	81	2	4.8	6.9
R30	10	175	758	8.15	B	81	2	4.8	7.0
R30	15	125/175	1049	11.15	B	85	2	5.4	7.8
R40	15	125	919	11.40	B	103	2	5.3	7.7
R40	15	175	782	9.75	B	100	2	5.9	8.5
R70	20	125	715	8.95	B	100	3	5.7	8.2
R70	20	175	665	8.35	B	100	3	6.0	8.7
R70	25	125	919	11.40	B	103	3	5.7	8.3
R70	25	175	782	9.75	B	101	3	6.4	9.3
R70	30	125/175	919	11.40	B	103	3	6.6	9.6

1. The values given in the “BELT DEFLECTION FORCE” table are calculated for nominal conditions and are provided for reference only. The required tension may vary due to application, manufacturing variances, component wear, etc. Drive belts must be kept tight enough to prevent slipping. If belts slip or squeak, they need to be tightened.
2. Belt cross-section can be found printed on the outside surface of the belt.



If belts are too tight, overload will be put on motor and motor bearings.

Maintenance Checklist

DAILY MAINTENANCE	
1	Check oil level of both compressor and engine if equipped. Add quality lubricating oil as required. See Section on "Oil Specifications".
2	Drain moisture from tank by opening tank drain valve located in bottom of tank. Do not open drain valve if tank pressure exceeds 25 PSIG.
3	Turn off compressor at the end of each day's operation. Turn off power supply at wall switch.

WEEKLY MAINTENANCE	
1	Clean dust and foreign matter from cylinder head, motor, fan blades, air lines, intercooler, and tank.
2	Remove and clean intake air filters.
3	Check V-belts for proper alignment and tightness:
a	Remove bolts and guard to access compressor drive.
b	See "Setting Belt Tension" Section for details on how to check and set proper tension.
c	If necessary, loosen mounting hardware which secures motor to base. Slide motor within slots of baseplate to achieve proper tension.
d	Check the alignment of pulleys. The compressor flywheel and motor sheave should be aligned within $\pm 1/2^\circ$ with notched belts and $\pm 2^\circ$ with wrapped belts. Adjust if necessary.
e	Tighten mounting hardware to secure motor on base.
f	Re-install guard and secure with bolts.

EVERY 90 DAYS OR 500 HOURS MAINTENANCE	
1	Change crankcase oil. Use type and grade oil as specified in the section on "Compressor Oil Specifications".
2	Check entire system for air leakage around fittings, connections, and gaskets, using soap solution and brush.
3	Tighten nuts and capscrews as required. See "Torque Values" section.
4	Check and clean compressor valves. Replace valves when worn or damaged. Replace valve gaskets after each inspection.
5	Pull ring on all pressure relief valves to assure free movement.





Troubleshooting Chart



Always disconnect unit from power supply and relieve all pressure from air tank before performing any maintenance. Failure to do so may result in personal injury or death. "Lock Out" or "Tag Out" all power sources.

Never operate unit without belt guard in place.

Never use gasoline or flammable solvent on or around compressor unit. Explosion may result.

Symptom	Possible Cause(s)	Corrective Action
Motor will not start.	<ol style="list-style-type: none"> 1. Main switch and fuses open. 2. Starter magnetic coils open. 3. Thermal overload tripped. 4. Defective pressure switch-contacts will not close 5. Low voltage. 	<ol style="list-style-type: none"> 1. Check all fuses and switches. Check for loose or faulty wires. 2. Check overload relay in starter. Reset starter. 3. Reset starter. If starter trips repeatedly, have electrical system inspected by an electrician. 4. Repair or replace pressure switch.  Warning – Relieve tank pressure before servicing. 5. Check with voltmeter. Be sure voltage corresponds to unit specifications.
Starter trips repeatedly.	<ol style="list-style-type: none"> 1. Improperly adjusted pressure switch. 2. Faulty check valve. 3. Incorrect fuse size or magnetic starter coil. 4. Low voltage. 5. Defective motor. 	<ol style="list-style-type: none"> 1. Adjust or replace.  Warning – Relieve tank pressure before servicing. 2. Clean or replace  Warning – Relieve tank pressure before servicing. 3. Be sure that fuses and coils are properly rated. 4. Check with voltmeter. Be sure voltage corresponds to unit specifications. 5. Replace motor.
Tank pressure builds up slowly.	<ol style="list-style-type: none"> 1. Air leaks. 2. Dirty air filter. 3. Defective compressor valves 	<ol style="list-style-type: none"> 6. Tighten fittings. 7. Clean or replace. 8. Install new valves.
Tank pressure builds up quickly.	<ol style="list-style-type: none"> 1. Excessive water in tank. 	<ol style="list-style-type: none"> 1. Drain tank.
Discharge pressure relief valve pops off while compressor is running.	<ol style="list-style-type: none"> 1. Wrong pressure switch setting. 2. Defective ASME relief valve. 	<ol style="list-style-type: none"> 1. Adjust to correct setting. 2. Replace valve.  Warning – Relieve tank pressure before servicing.
Compressor will not unload (Units with head unloaders)	<ol style="list-style-type: none"> 1. Wrong pilot valve setting. 2. Defective pilot valve. 3. Lack of air to pilot valve. 	<ol style="list-style-type: none"> 1. Adjust to correct setting. 2. Replace pilot valve. 3. Open ball valve to pilot valve.
Excessive belt wear.	<ol style="list-style-type: none"> 1. Pulley out of alignment. 2. Belts too tight or too loose. 	<ol style="list-style-type: none"> 1. Realign motor pulley. 2. Adjust belt tension.
Compressor runs hot.	<ol style="list-style-type: none"> 1. Improper flywheel rotation 2. Defective compressor valves. 3. Dirty air filter. 4. Dirty cylinder and/or intercooler. 	<ol style="list-style-type: none"> 1. Check for correct rotation. (Counter clockwise when viewed from drive side.) 2. Install new valve plate assembly. 3. Clean or replace. 4. Clean cylinder fins and/or intercooler.

Troubleshooting Chart (continued)

Symptom	Possible Cause(s)	Corrective Action
Interstage pressure relief valve pops off.	<ol style="list-style-type: none"> 1. Defective compressor valves. 2. Improper valve installation. 	<ol style="list-style-type: none"> 1. Install new valves. 2. Verify proper valve placement.
Excessive oil consumption.	<ol style="list-style-type: none"> 1. Dirty air filter. 2. Wrong oil viscosity. 3. Oil leaks. 4. Worn piston rings. 5. Scored cylinder 	<ol style="list-style-type: none"> 1. Clean or replace. 2. Refill with proper viscosity oil. 3. Tighten bolts. Replace gaskets. 4. Replace rings. 5. Replace cylinder.
Air escapes from centrifugal unloader when unit is running	<ol style="list-style-type: none"> 1. Centrifugal unloader release valve dirty or defective. 	<ol style="list-style-type: none"> 1. Clean or replace valve
Air escapes from centrifugal unloader when unit is stopped.	<ol style="list-style-type: none"> 1. Check valve stuck in open position. 	<ol style="list-style-type: none"> 1. Replace check valve. <p> Warning – Relieve tank pressure before servicing.</p>
System does not alternate (Duplex units only)	<ol style="list-style-type: none"> 1. Starter tripped. 2. Loose wiring in alternator. 3. Defective alternator. 4. Defective motor. 	<ol style="list-style-type: none"> 1. Reset starter. If starter trips repeatedly, have electrical system inspected by an electrician. 2. Check and tighten all wiring connections. 3. Replace alternator. 4. Replace motor.



* C Q F 3 4 7 3 V E R 0 1 *
CQF3473VER01

CHAMPION

COMPRESSED
AIR ADVISORS

Inc.

Compressed Air Advisors, Inc.

Phone: 877.247.2381

info@compressedairadvisors.com

www.compressedairadvisors.com



 Please recycle after use.