

Edge iO28 Specifications (Hardware V1.5)

Power Options and Requirements:	
Via Terminal	Power Supply: 24VAC +/- 3% or 24VDC +10%/-10% Consumption 100 mA
Connectivity:	
Ethernet	2x Ethernet (Switch) Ethernet 10/100base-T auto-selection
Communication Options:	
SSH over IP	Edge iO28 gets IP address via DHCP via default, can be configured as Static
Edge Connect Module	Provides power and breakout for I2C, UART and GPIO add-on modules

Available IO	
Universal Inputs	7
Digital Inputs	7
Universal Outputs	7
Digital Outputs	5
Relays	2

Edge Connect Module	
I2C Channels	2
UART Channels	2
GPIO	1
Power	5V DC wired or 24V serial connection

Input/Output Details

Name	Tolerance	Usage
Digital Inputs	Dry Contact	Detecting the closing or opening of circuit
Universal Input	0-10V DC, 4-20ma, 10/20K Resistor	Measuring 0-10V Sensors, Voltage, Temperature and current
Universal Output	0-12V @ 50ma Max	Controlling voltage variable equipment. Can drive a slim-line relay
Digital Output	0V - 12V On-Off	Controlling relays, enabling equipment
Relays	Max 24V/2amp Capable of switching 3.3VDC to 48VDC and VAC	NO dry contact



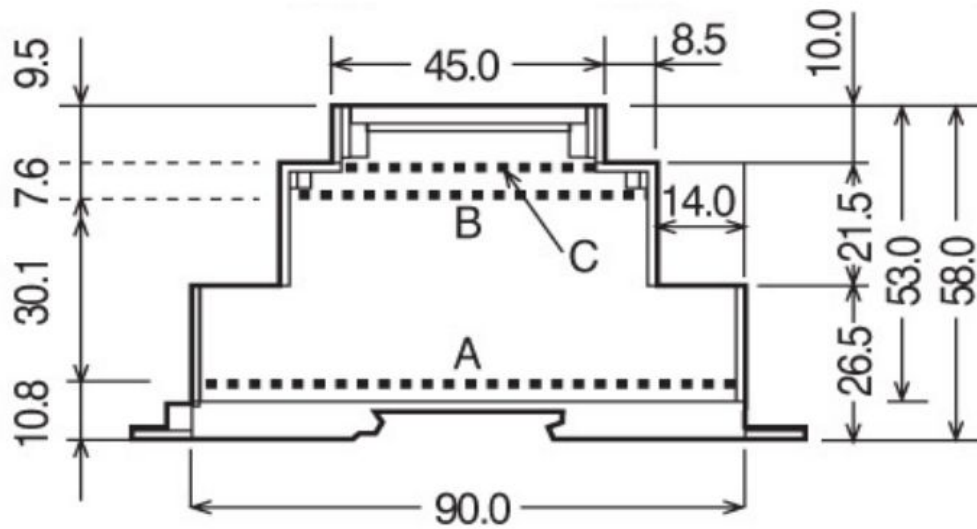
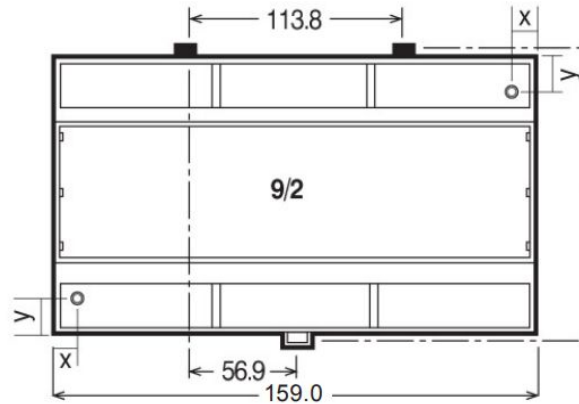

Dimensions

Length	159 mm
Width	90 mm
Height	58 mm
Material Type	Plastic (Polycarbonate)
UL Rating	UL94-V0
IP Rating	IP20
Mounting	DIN mount
Weight	335 gms



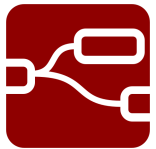

Computing and Programming

Physical Specs		Processor: AM335x 1GHz ARM® Cortex-A8 512MB DDR3 RAM 4GB 8-bit eMMC on-board flash storage NEON floating-point accelerator 2x PRU 32-bit microcontrollers USB client for power & communications USB host Optional storage of an SD card upto 64Gb
OS Software		Debian based OS
Software		JVM and node-js are default installed on the device
Programming		Local Flow Based Programming On-board API Node Red

Universal Input Jumper Settings:

The Universal Inputs of the Edge are used to set the configuration from 10/20K Resistor, 0-10V DC and 4-20ma. There are three settings to configure universal input type, set with a 2-pin **jumper**.



Mode	Purpose	Setting
10/20K Resistor	Connect a thermistor to the input and common.	
4-20 ma	Using 4-20 ma sensitive sensors.	
0-10 VDC	Measuring 0-10 VDC.	

Overview

The Nube-iO Edge iO-28 is a general purpose ethernet based building controller. There are 28 onboard inputs and outputs. The controller can be setup as a master and or slave configuration for IO expansion.

The Edge iO-28 can be programmed as remote IO via flow based programming. Alternatively, for application specific control, the logic code can be loaded directly onto the Edge iO-28.

Feature Spotlight	<ul style="list-style-type: none"> ● Equipment condition monitoring, HVAC, lighting, temperatures, and occupancy. ● Collection, storage, and analysis of large amounts of data. ● Structured export of data for use with other analysis tools. ● Browser based programming. No need for expensive software and licensing. ● Support for low cost hardware and sensors. ● Compatibility and integration with third party products. ● Remote Monitoring via system alarms, email, and SMS notifications, allows you to respond to issues as they occur. This reduces equipment downtime and can prevent unnecessary service calls.
Potential Data Exchange Methods	<ul style="list-style-type: none"> ● MQTT ● Onboard database storage ● Obix (Can push data to an Obix Server) ● Inbuilt Modbus TCP Server ● JSON ● XML ● CSV ● LoRa (Long Range/Low Power Wireless sensors) ● KNX (Read and write to KNX device)
Compatible Security Options	<ul style="list-style-type: none"> ● TLS or SSL Security ● AES256 remote access encryption ● Payload encryption ● Device blacklisting ● Device SSL certificates

About Nube iO

Designed by HVAC controls experts, Nube iO provides a reliable and economical platform to control and monitor your HVAC system. With emphasis on utilizing open platforms and device security Nube iO allows you to break free from restrictive BMS platforms without the huge cost of having to replace existing controllers.

Born in the age of IoT, Nube iO provides you with the ability to access your data from the web. No longer do you need hundreds of sensors or a huge budget in order to get your data online. Whether you have one sensor or thousands, the scalability of the platform makes it economical regardless of the size of your system.

To learn more about our products and solutions, visit: nube-io.com

