

XV-A1

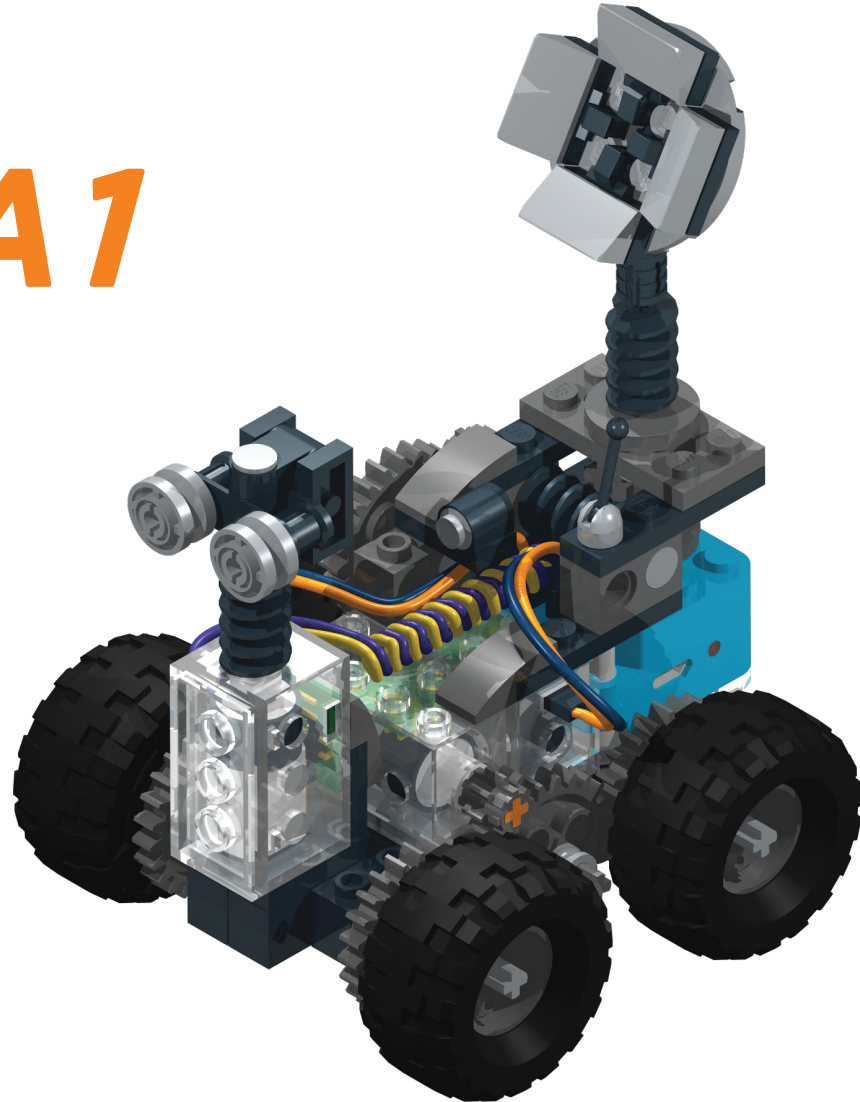

1

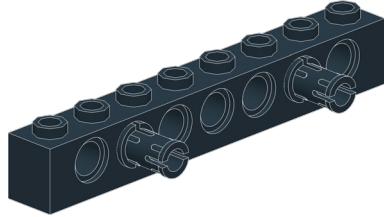

1

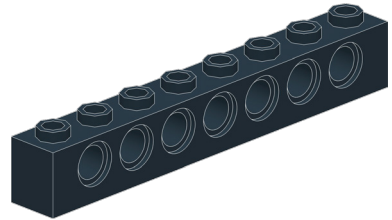

2

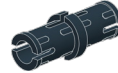

2

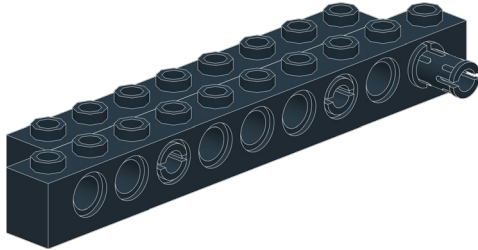

1

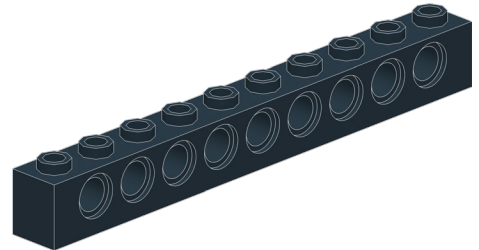

1



3

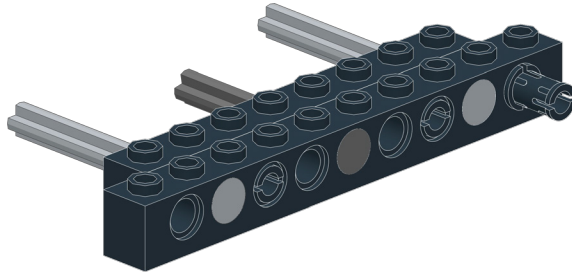

2

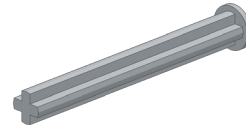

5

1

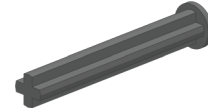

4

1:1 SCALE



1:1 SCALE



4

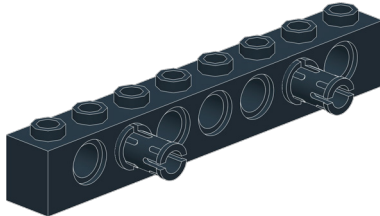

1

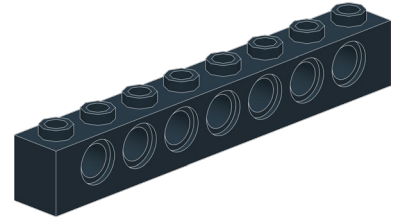

2



5

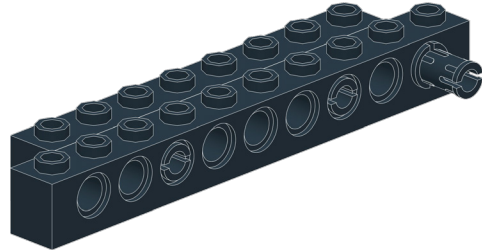

1

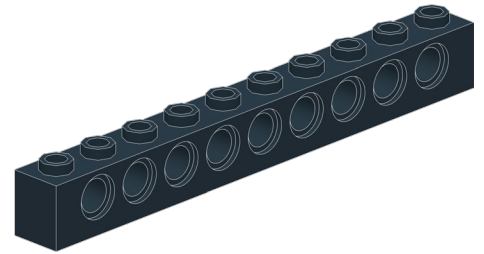

1



1:1 SCALE



1:1 SCALE



6

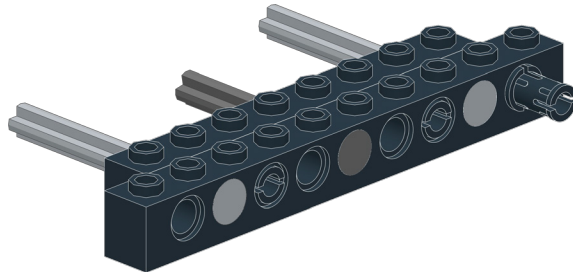

2

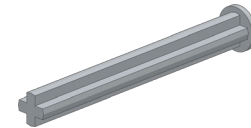

5

1

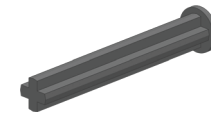

4

7

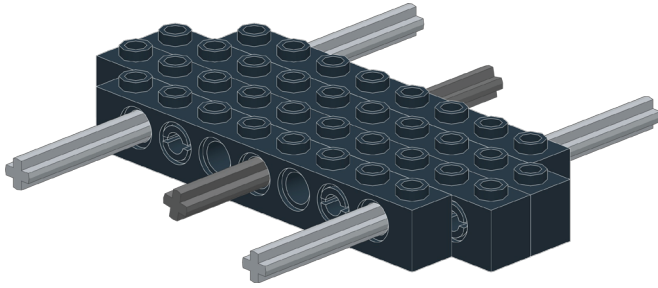

2

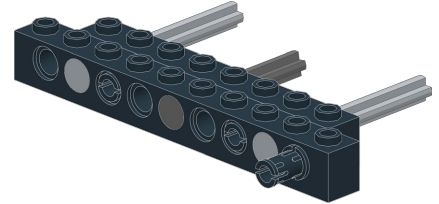

8

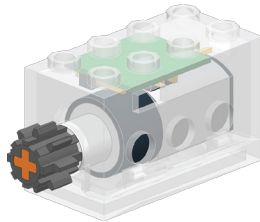
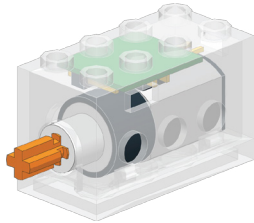

2x

2

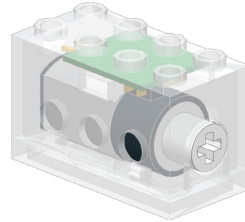

2



2



9

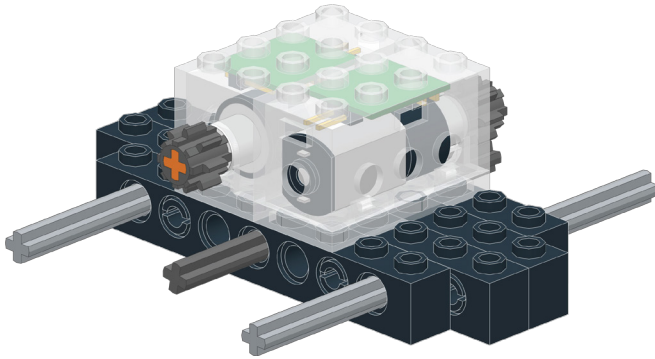

2

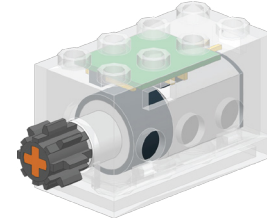

10

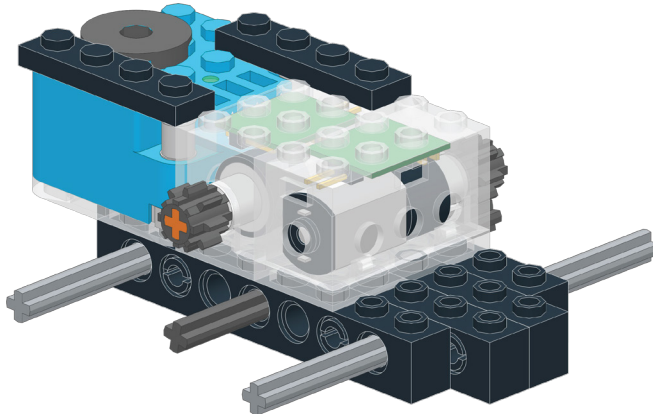

1

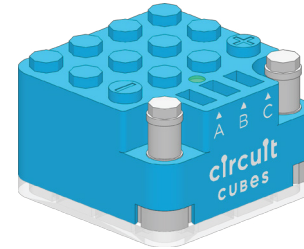

1



2

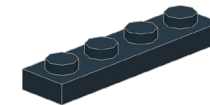

11

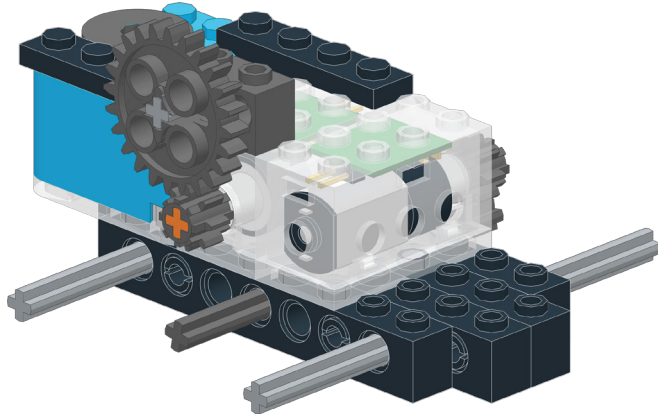

1

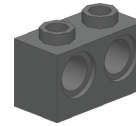

1

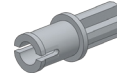

1

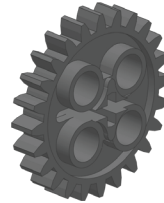

12

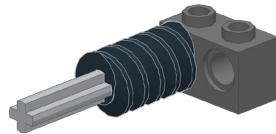

1

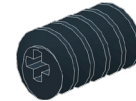

1

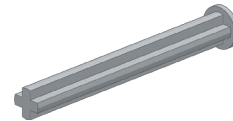

5

1

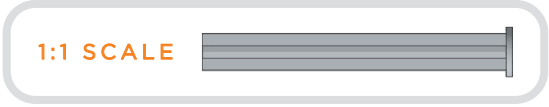
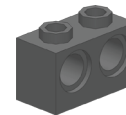

13

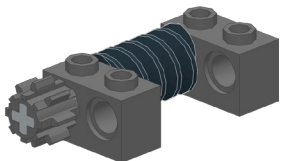

1

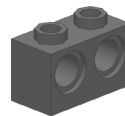

1



14

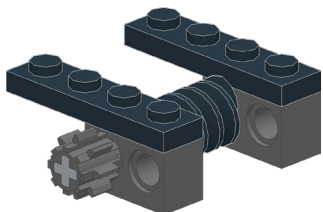

2

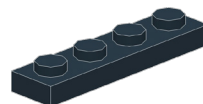

15

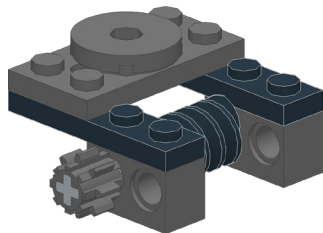

1

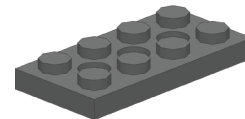

1



16

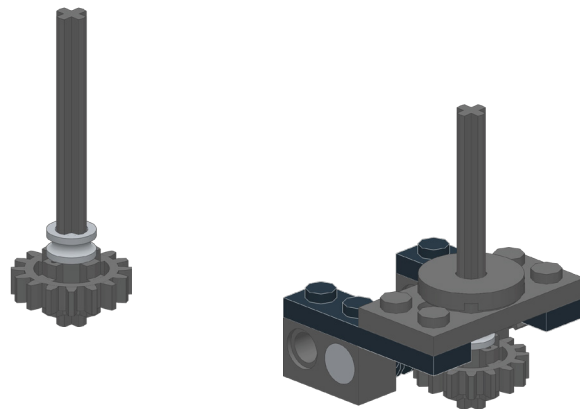

1



1



1



17

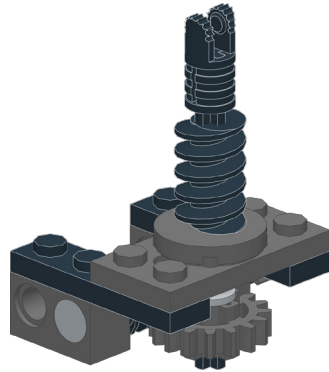

1

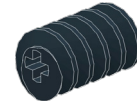

1



18

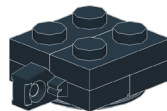
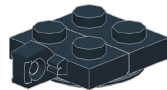

1



1

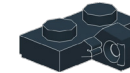

3

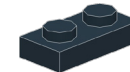

19

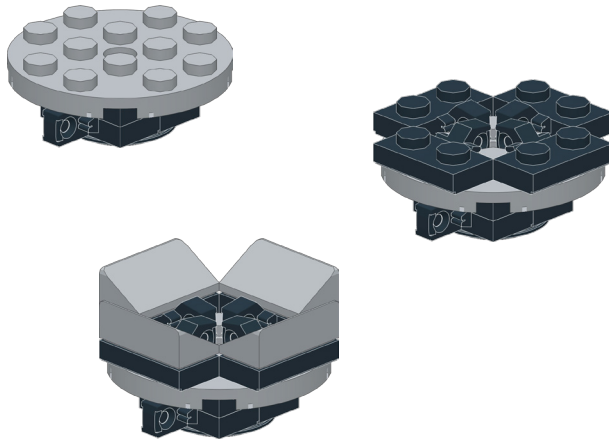

- 1
- 1
- 4
- 4

20

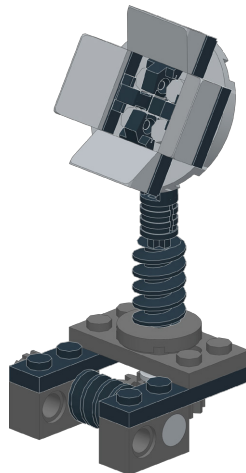

- 1
- 1

21

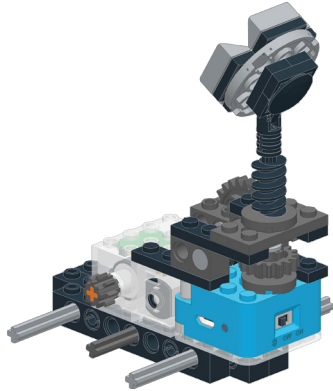

1

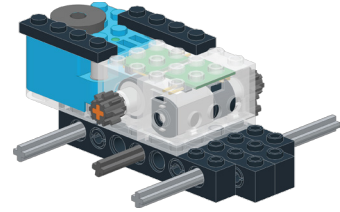

1



22

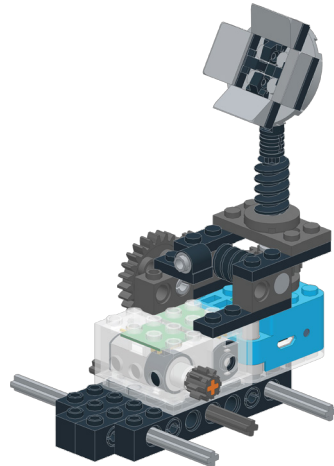

1



1

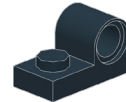

23



2



1



24

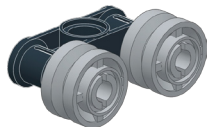
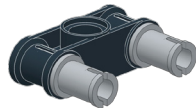

2

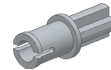

1



2



25

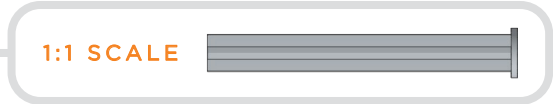
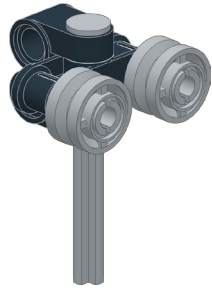

26

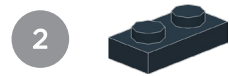
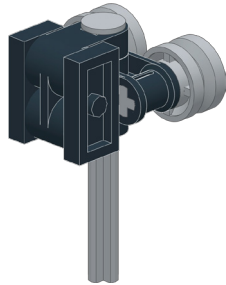

27

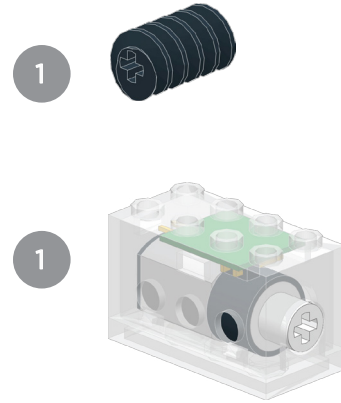
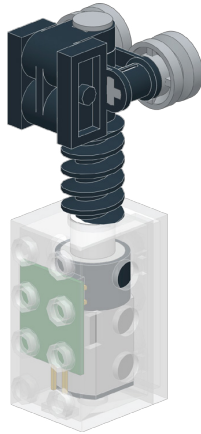

28

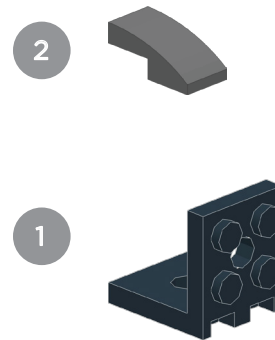
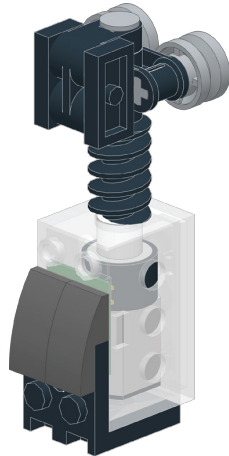

29

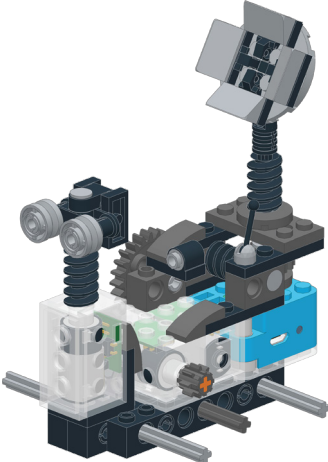

1

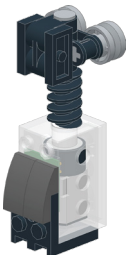

30

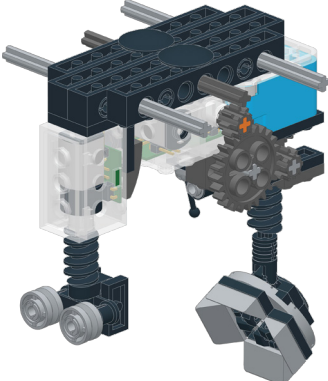

2



31

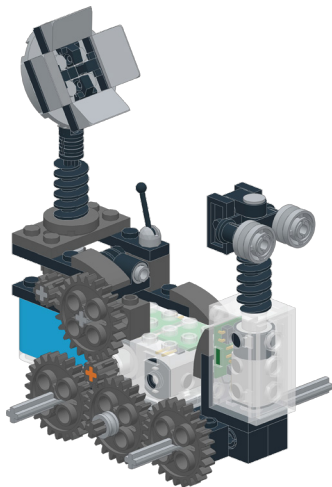

3

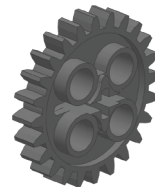

1



32

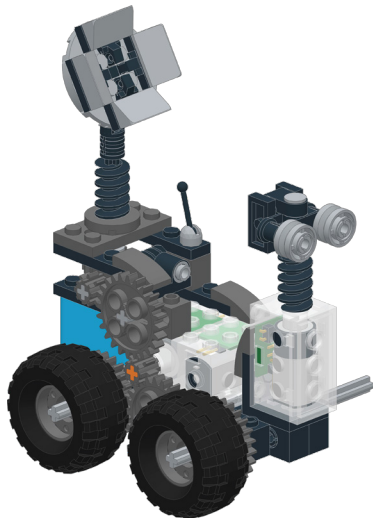

2



2



33

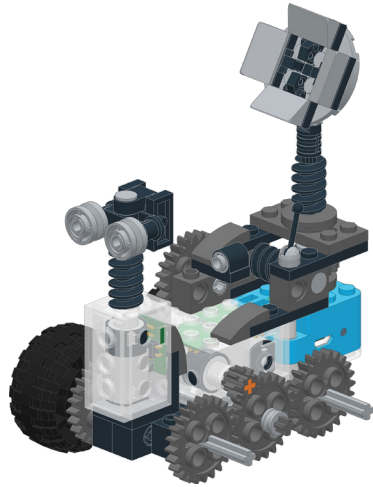

3

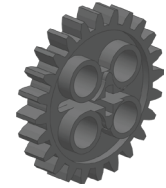

1



34

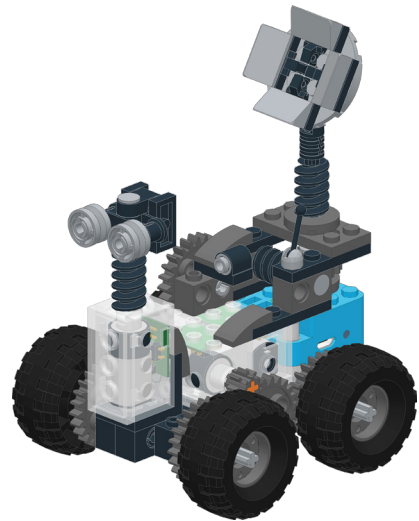

2



2



35

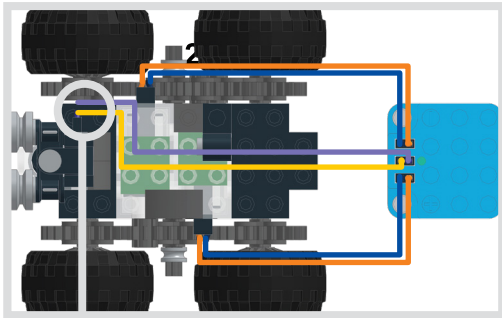

1

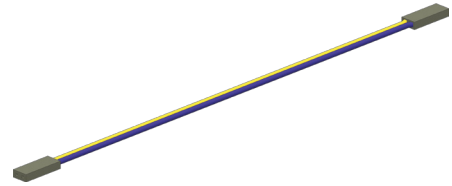

2

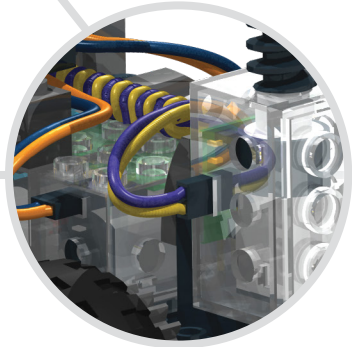

36

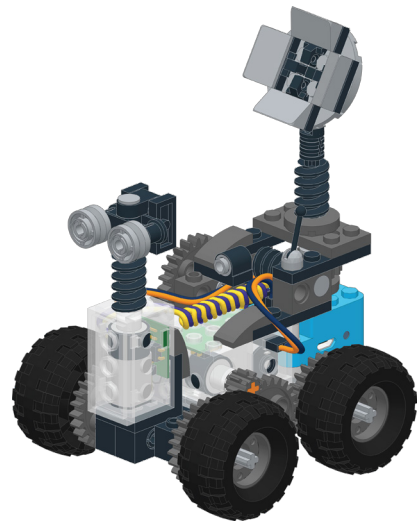

XV-A1 CONTROLS

