

# *XR-B4*

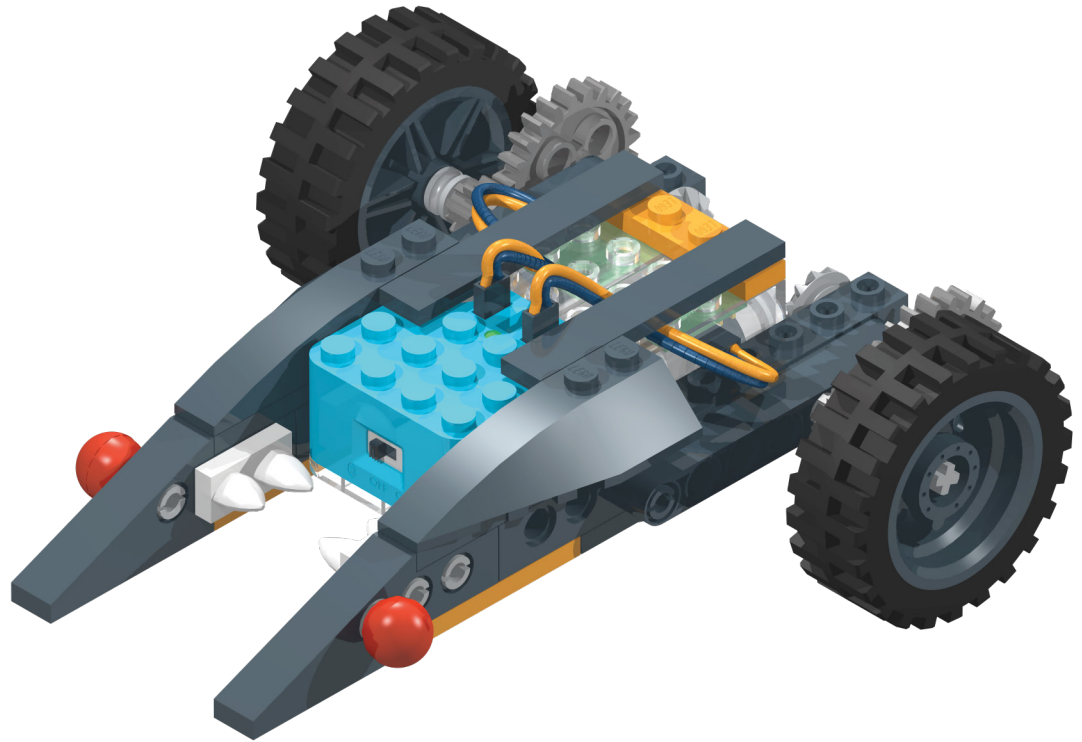

1

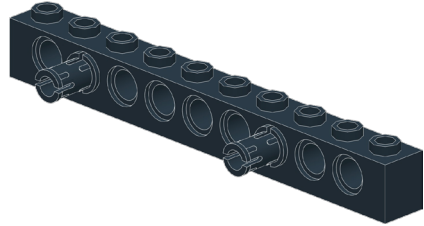

1

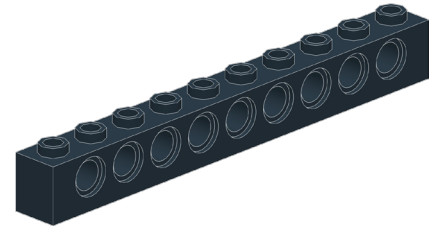

2



2

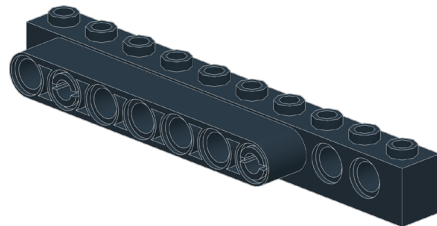

1

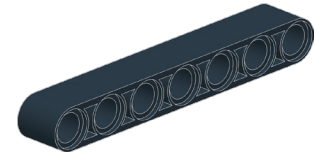

3

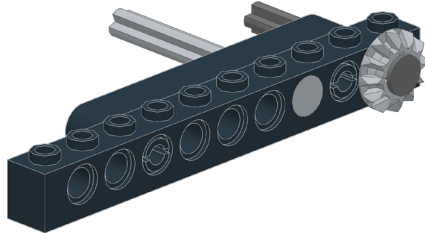

1



4

1

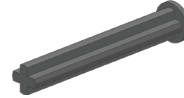

5

1

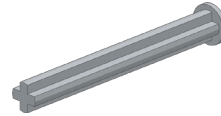

1:1 SCALE



1:1 SCALE



4

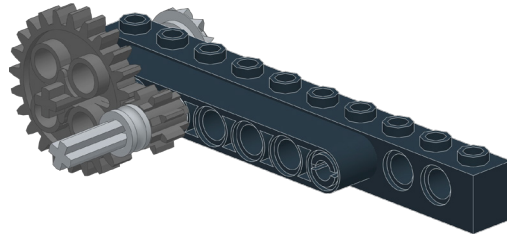

1

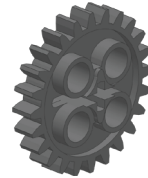

1



1



5

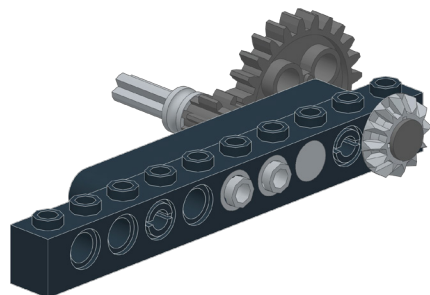

2



6

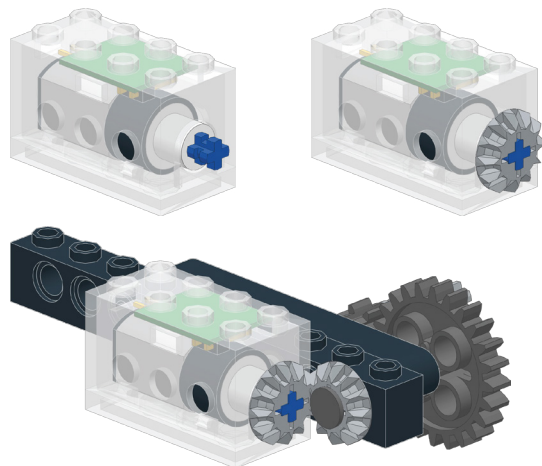

1

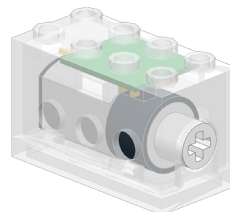

1



1



7

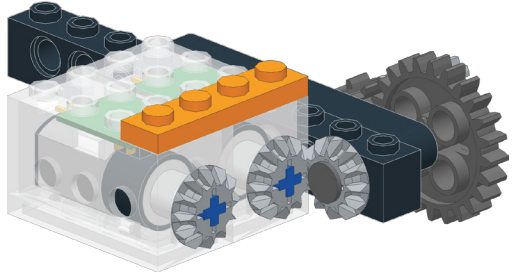
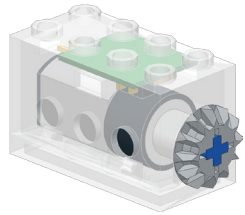

1

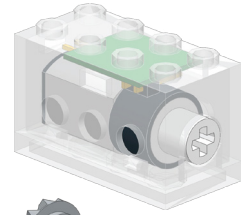

1



1



1

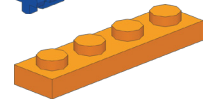

8

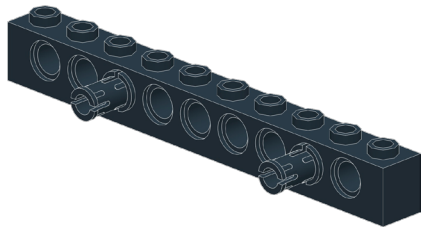

1

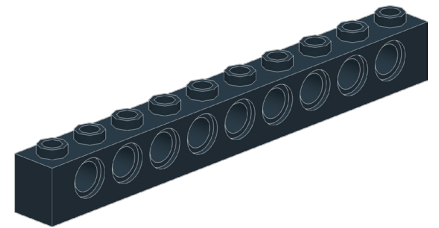

2



9

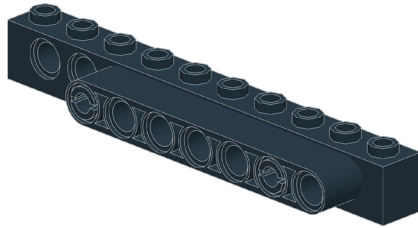

1

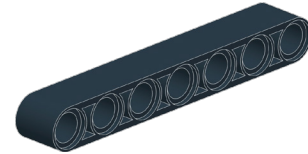

1:1 SCALE



1:1 SCALE



10

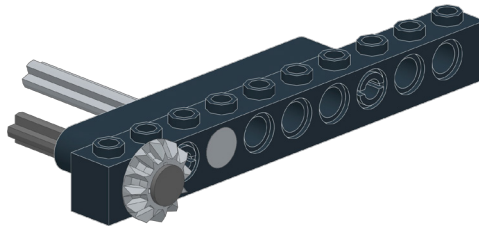

1



4

1

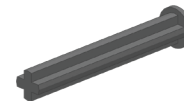

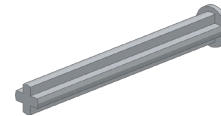

5

1

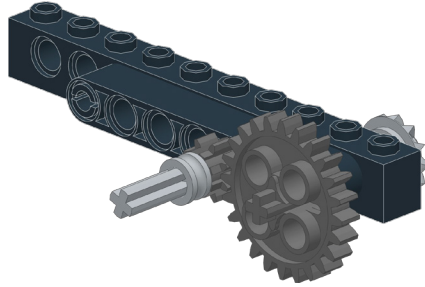

11

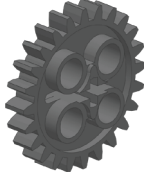

- 1 
- 1 
- 1 

12

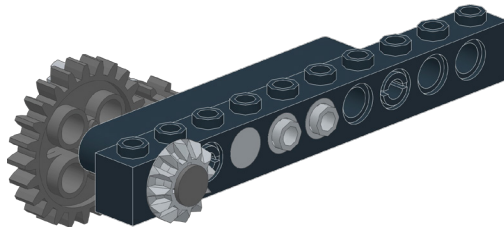

- 2 

13

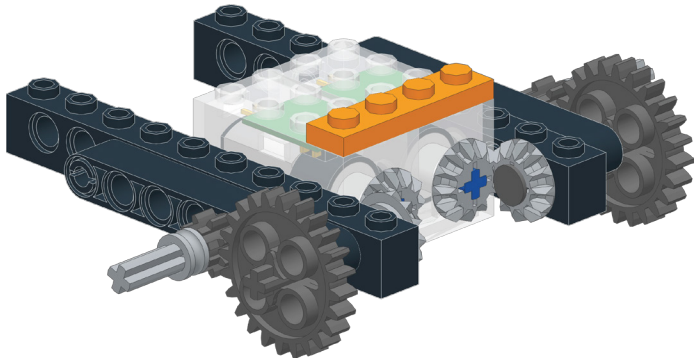

1

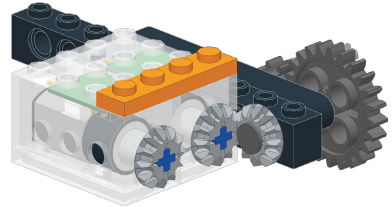

1

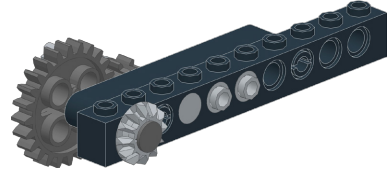

14

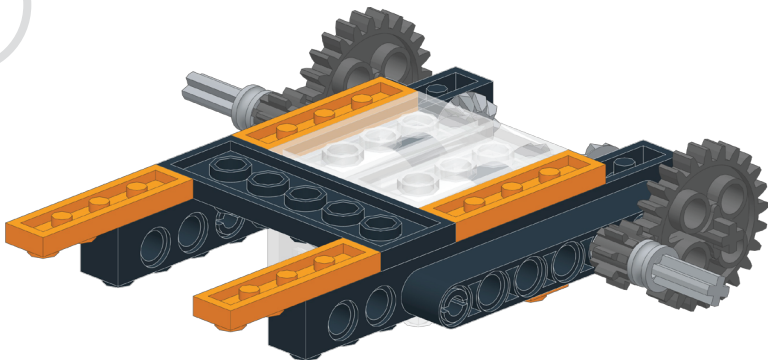

4

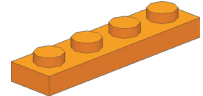

1

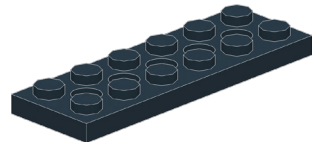



15

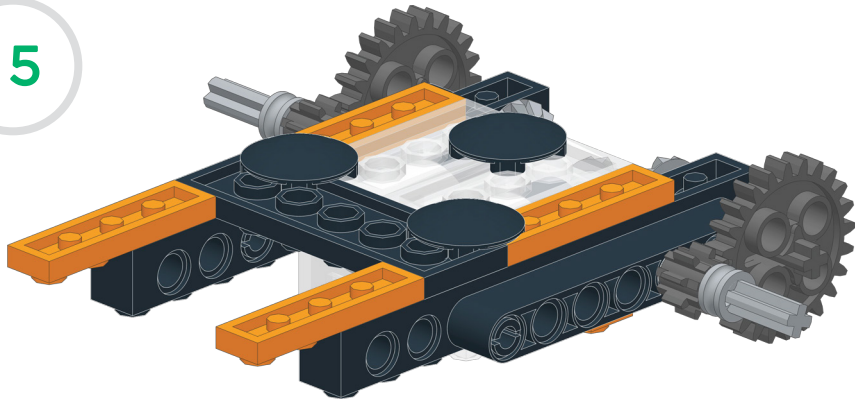

3



16

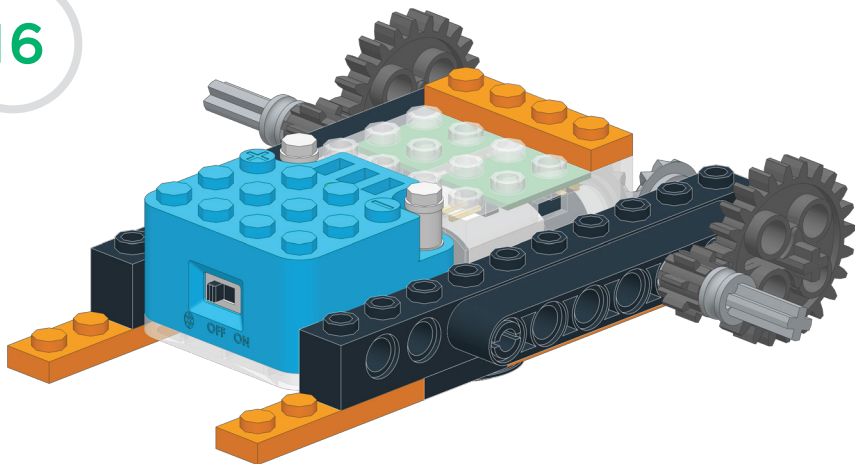

1

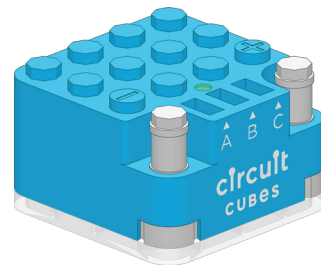

17

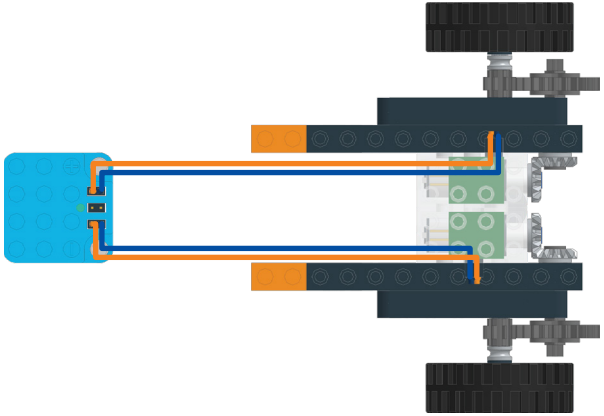

2



18

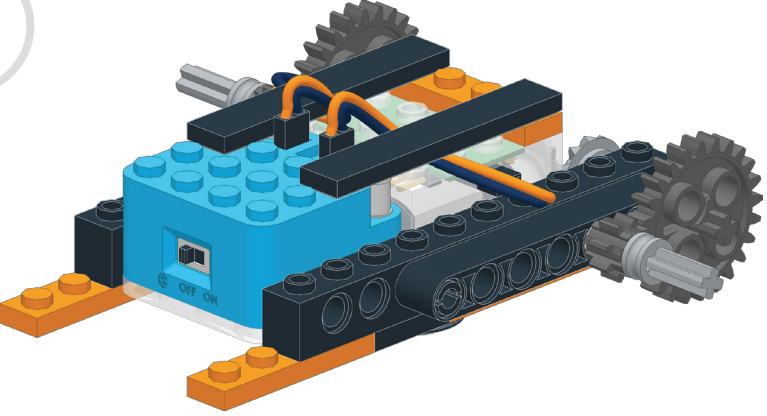

2

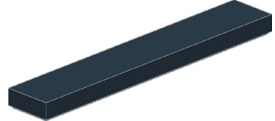

19

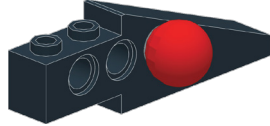
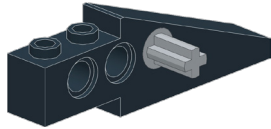

- 1
- 1
- 1

20

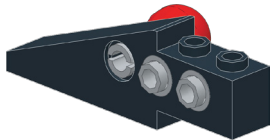
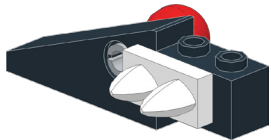

- 2
- 1

21

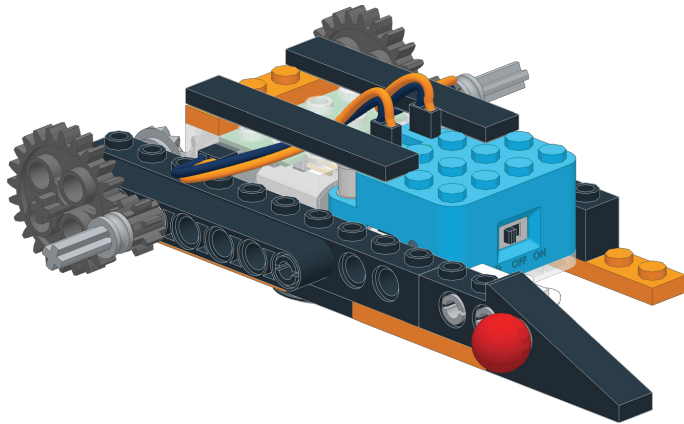

1

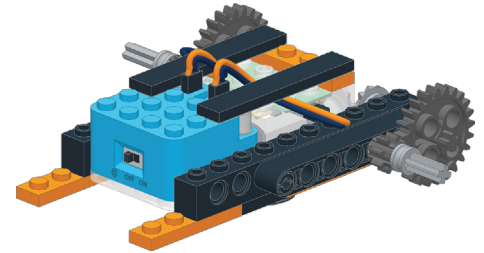

1

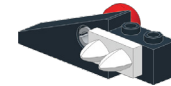

22

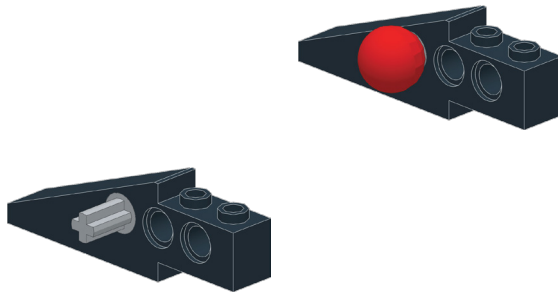

1

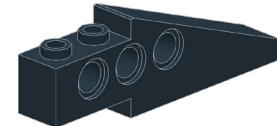

1

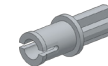

1



23

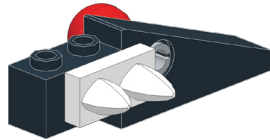
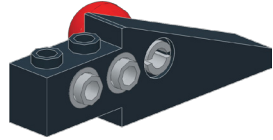

2



1

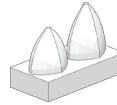

24

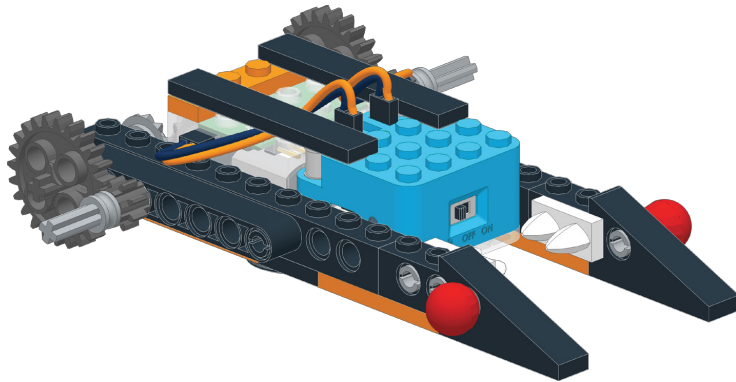

1

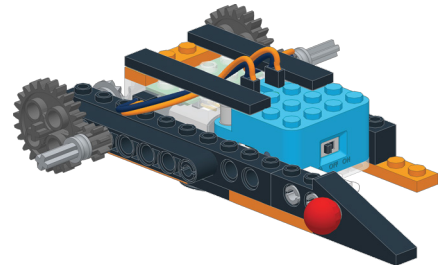

1

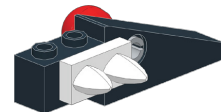

25

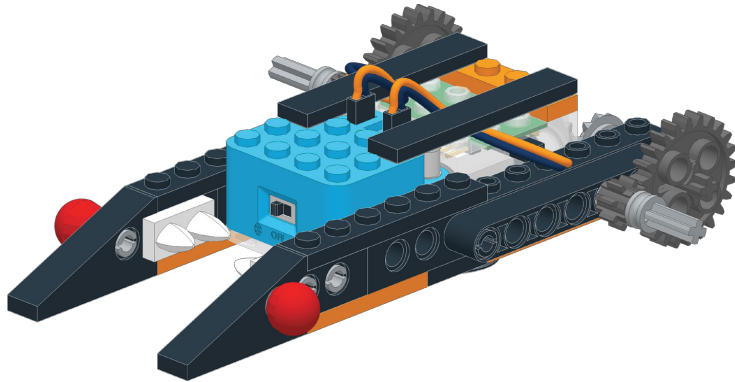

2

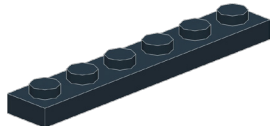

26

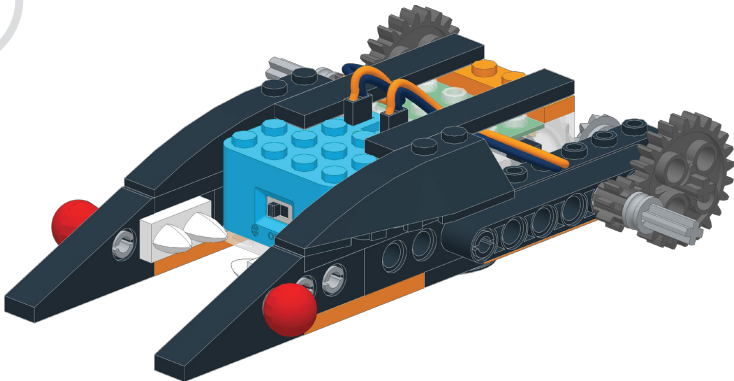

1

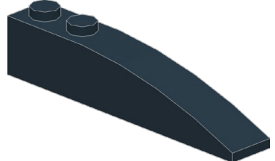

1

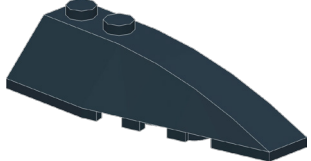

27

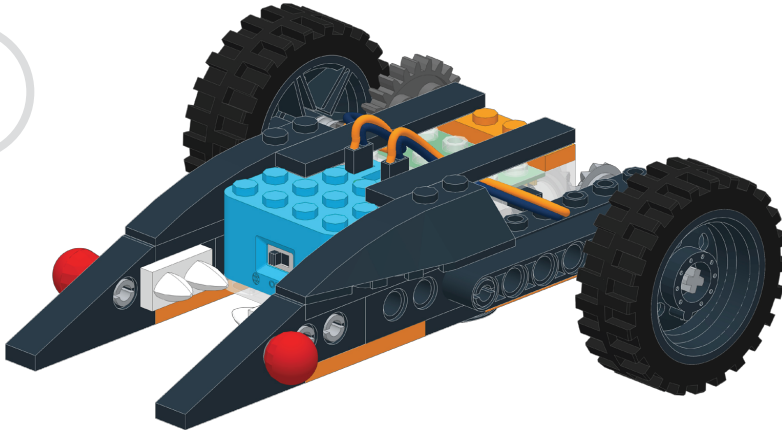

2



2



## XR-B4 CONTROLS

