

XM-A3

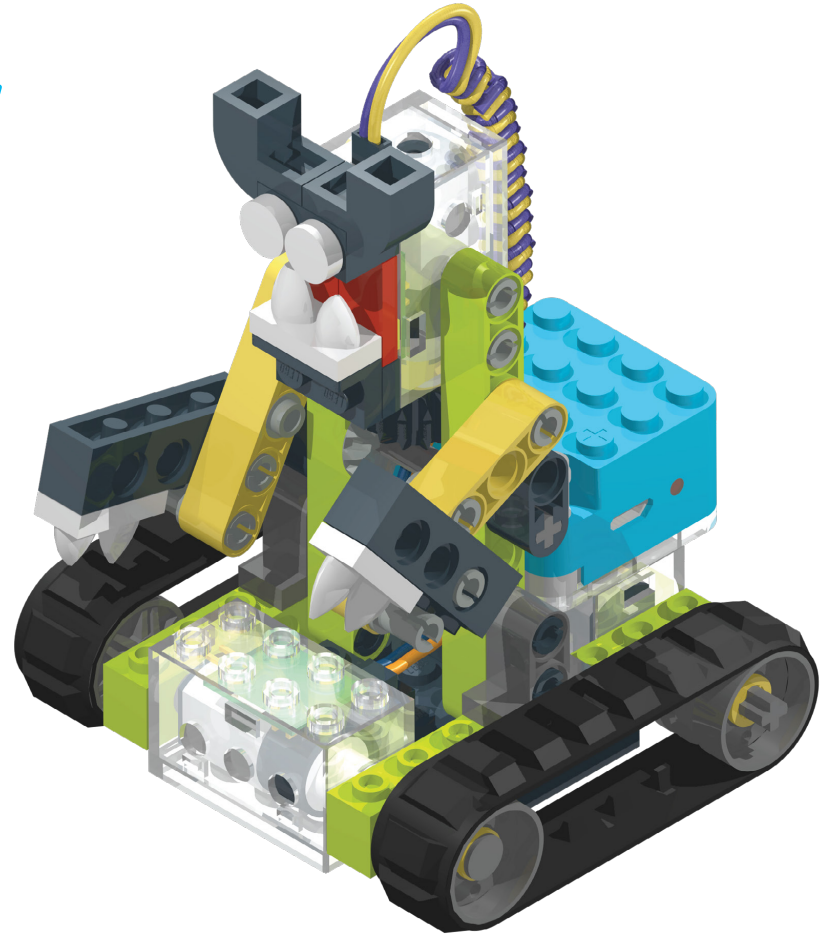

1

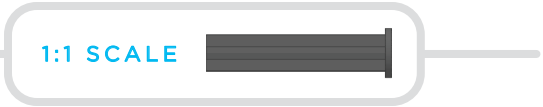
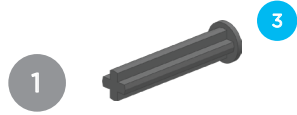
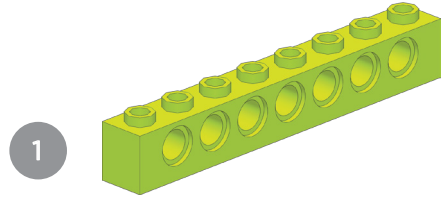
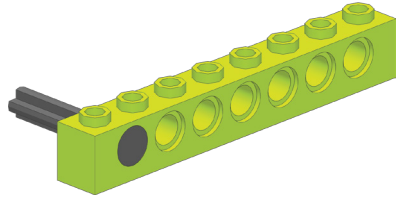

2

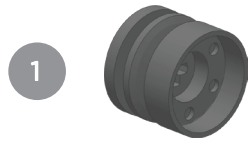
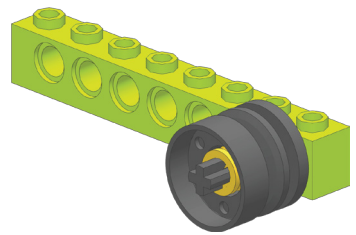

3

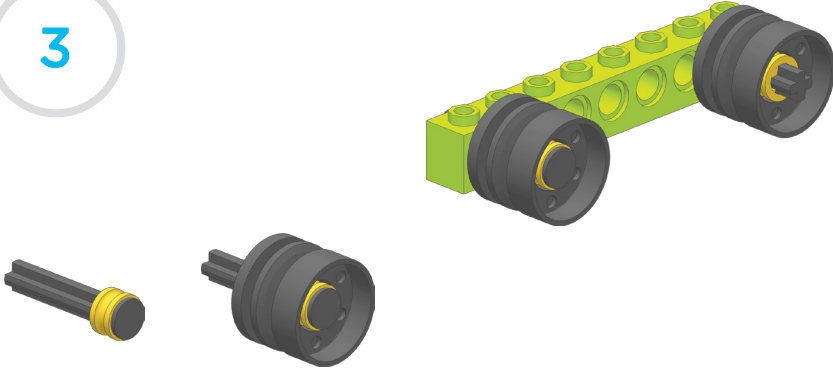

1



1

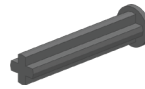

3

1

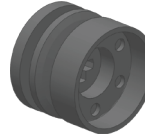

1:1 SCALE



4

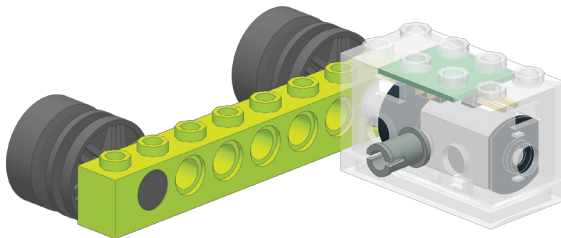

1

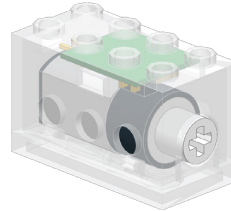

1



7

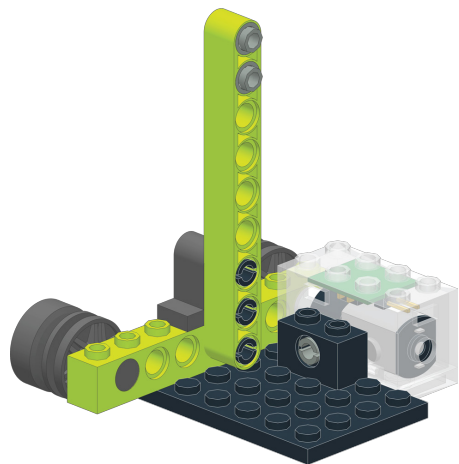

1

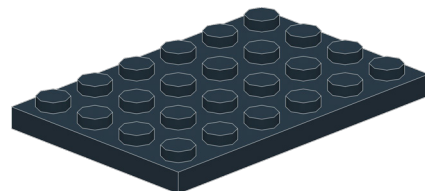

8

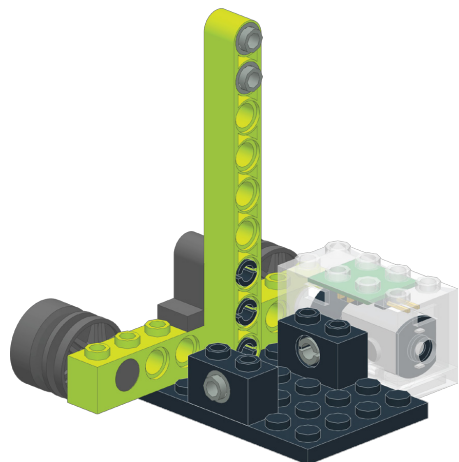

1

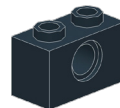

1



9

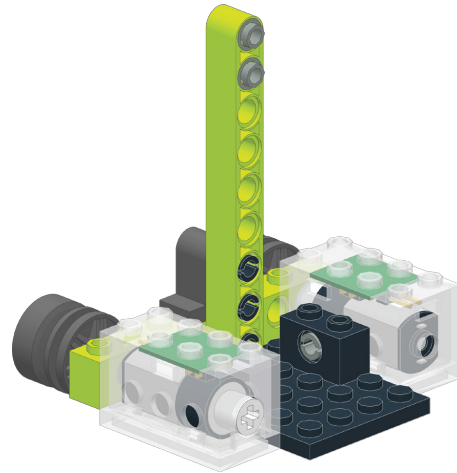

1

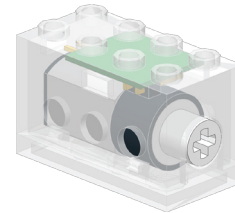

10

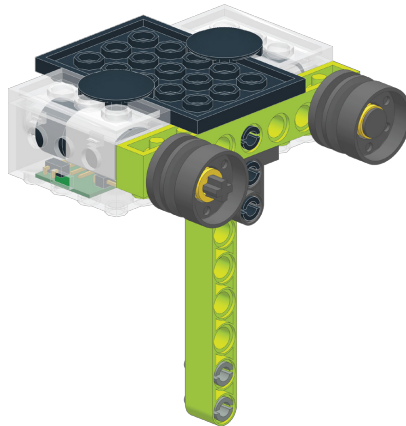

2



11

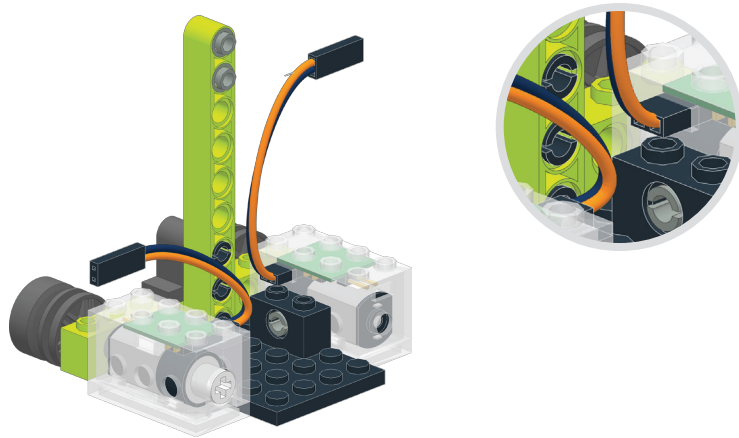

2



1:1 SCALE

12

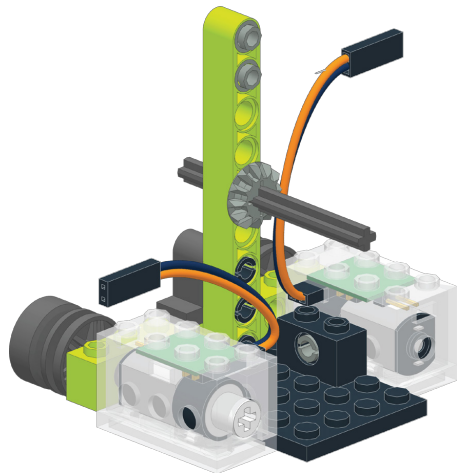

1



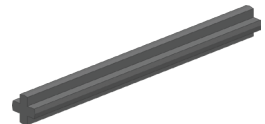

6

1



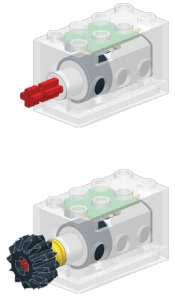
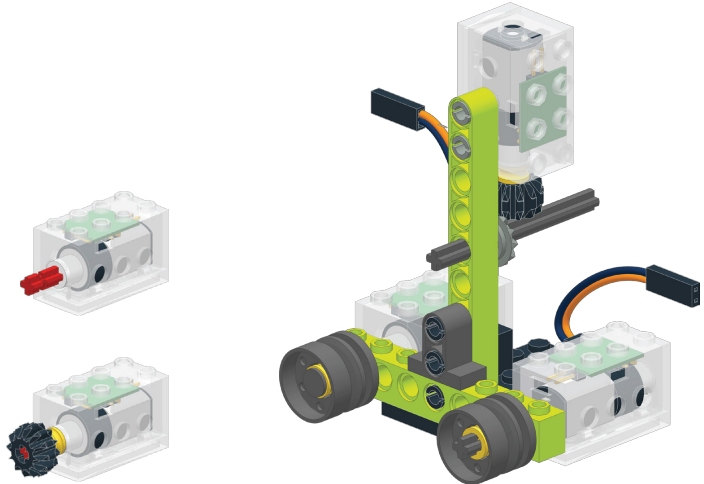

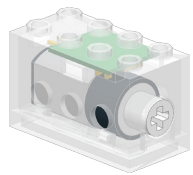
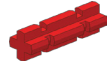
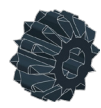
13

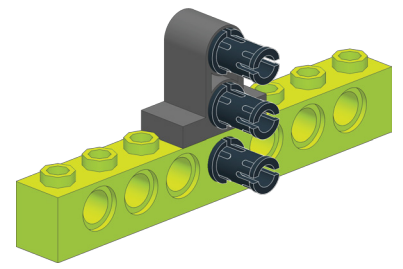

- 1 
- 1 
- 1 
- 1 

14

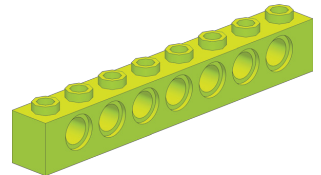
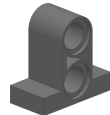

- 1 
- 1 
- 3 

15

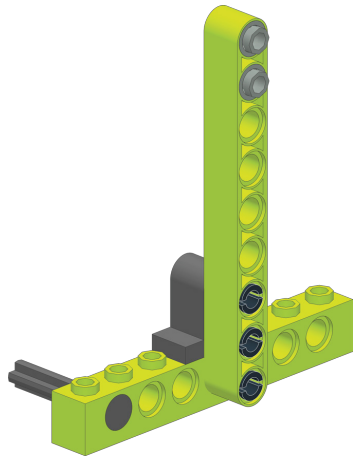

- 1
- 1
- 2

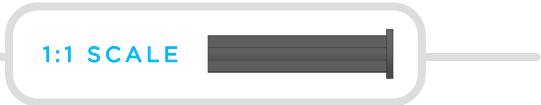

16

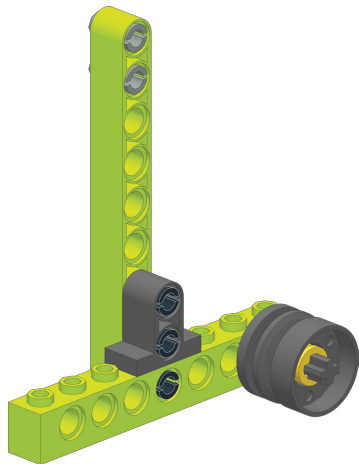

- 1
- 1

17

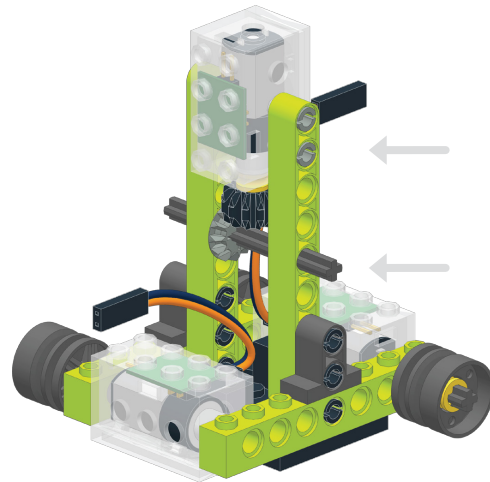

1

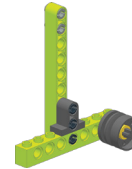

1

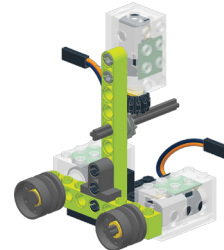

1:1 SCALE



18

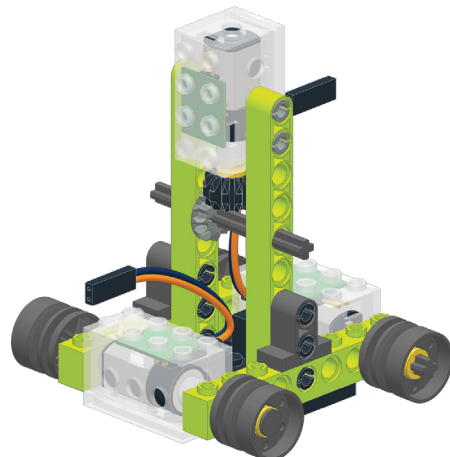
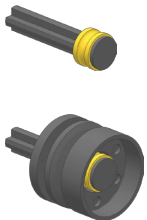

1



1

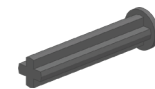

3

1



19

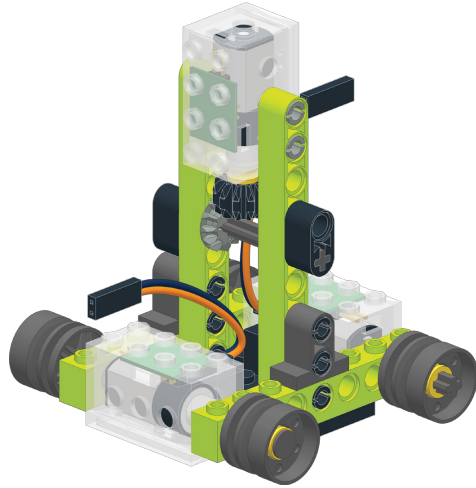

2



20

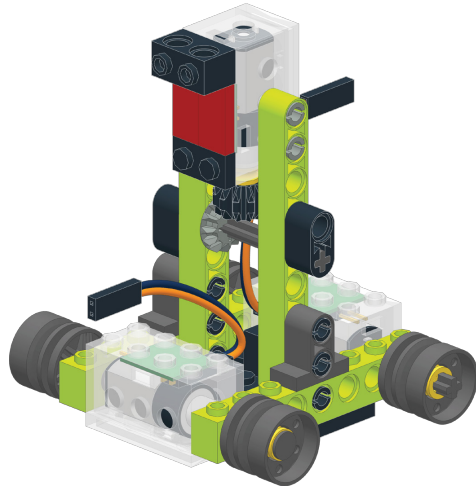

1

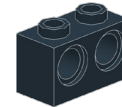

1

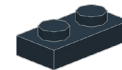

2

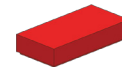

21

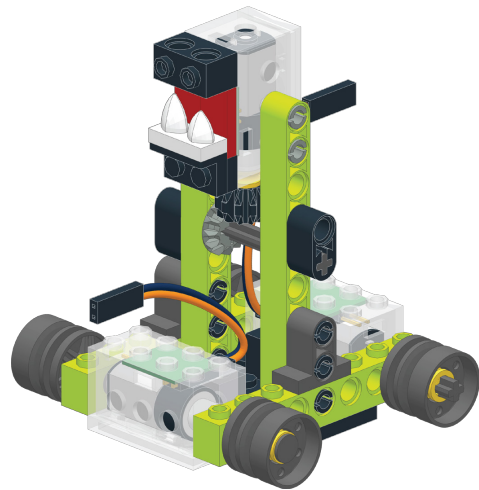

1

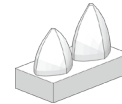

1

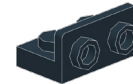

22

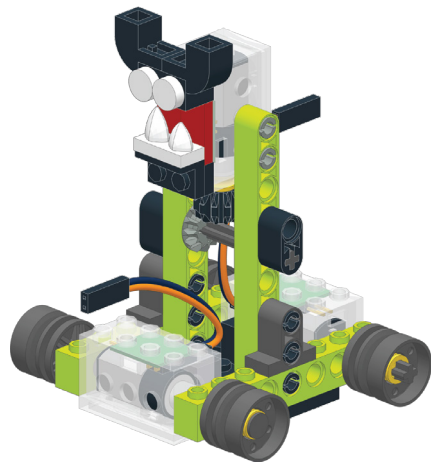

2

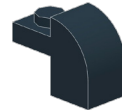

2



23

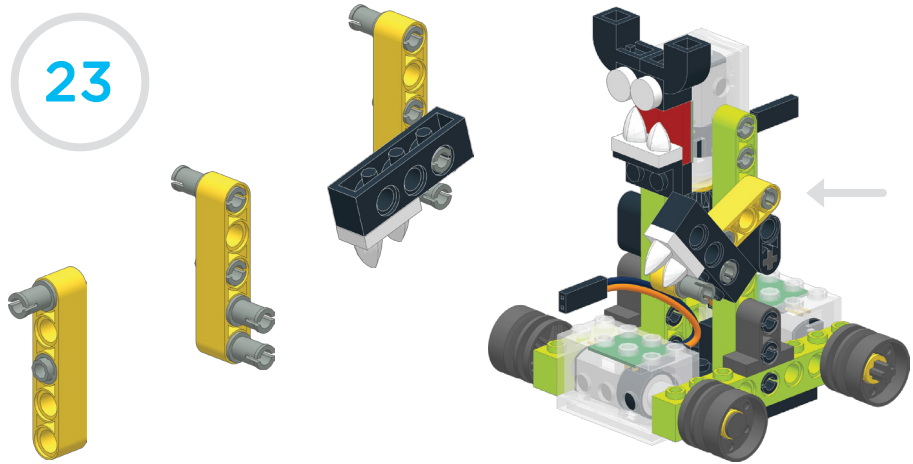

- 3
- 1
- 1
- 1
- 1

24

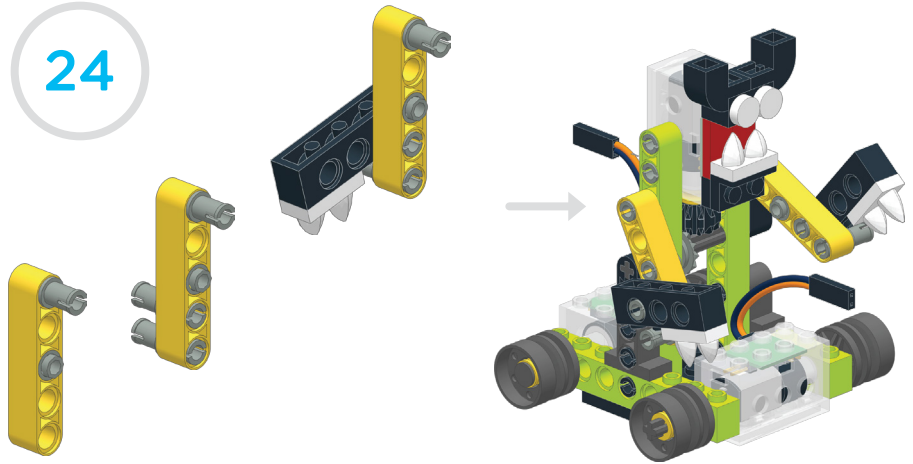

- 3
- 1
- 1
- 1
- 1

25



2



26

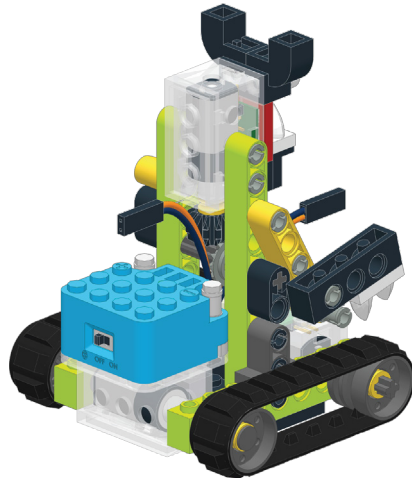

1

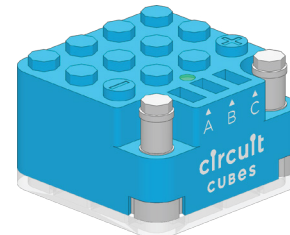

27

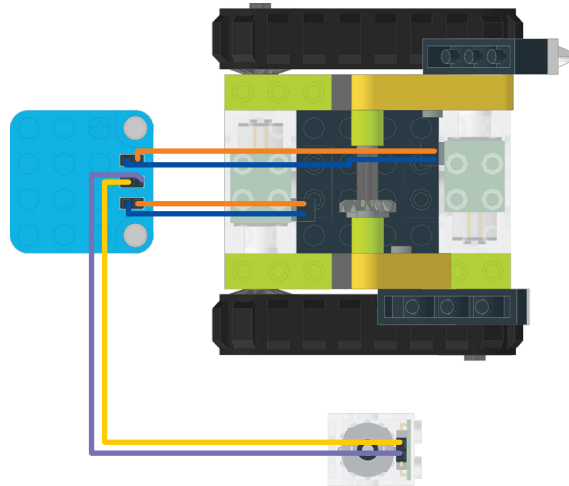

1

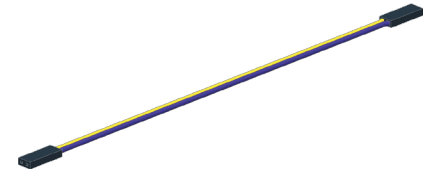

XM-A3 CONTROLS

