

# *XM-A1*

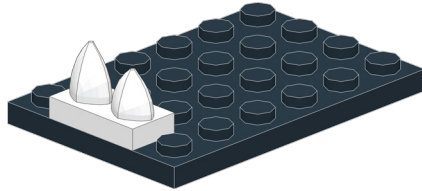

1



1

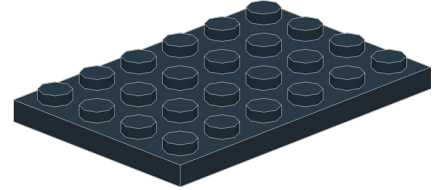

1

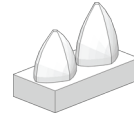

1:1 SCALE



2

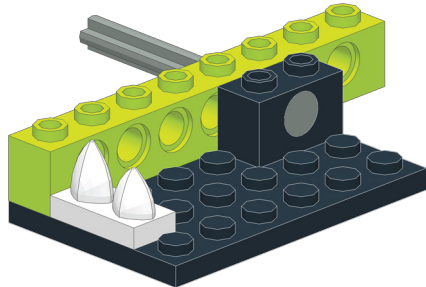

1

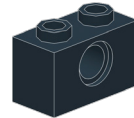

1

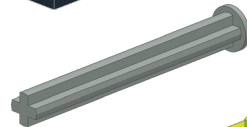

5

1

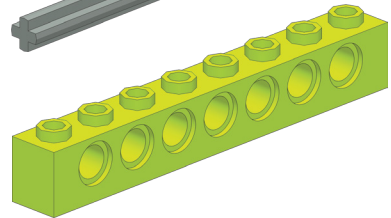

3

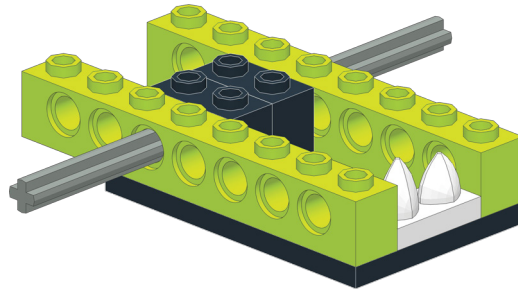

1

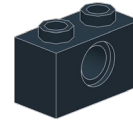

1

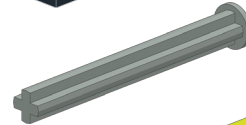

5

1

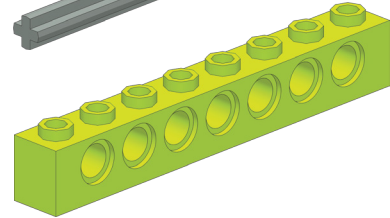

1:1 SCALE



4

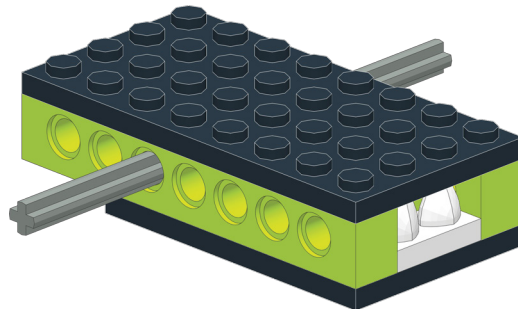

1

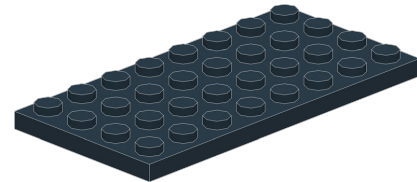

5

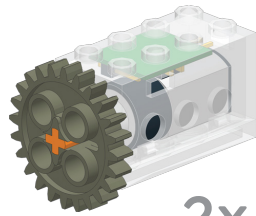

2x

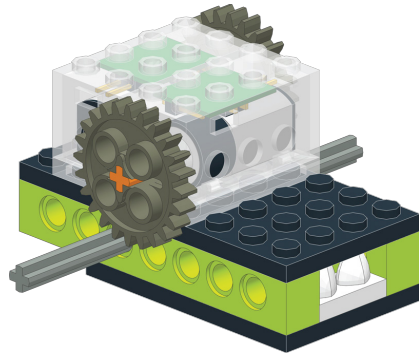

2

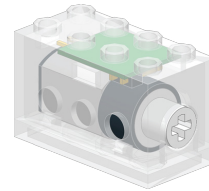

2

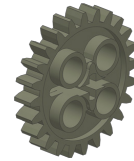

2



6

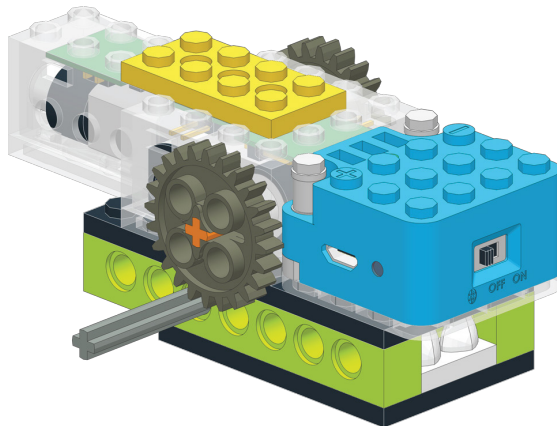

1

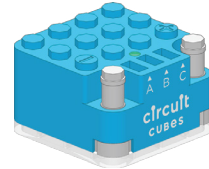

1

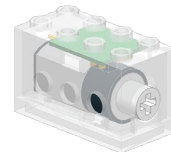

1

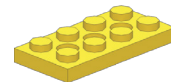

7

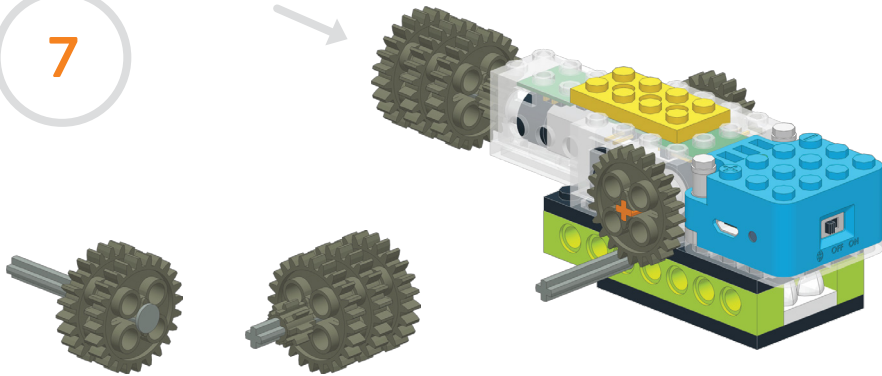

1



3

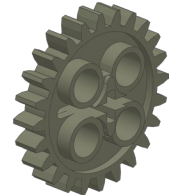

5

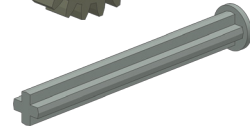

1

1:1 SCALE



8

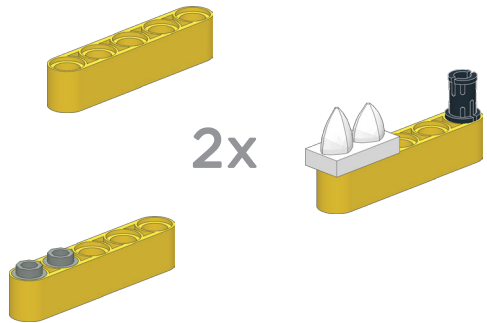

2x

4



2



2

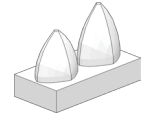

2

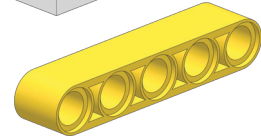

9

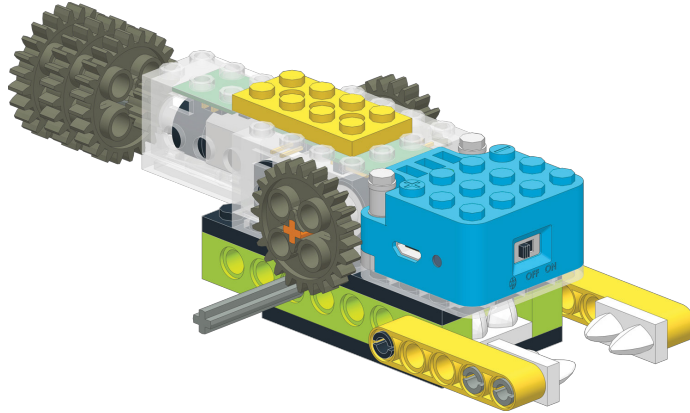

2

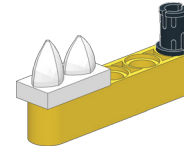

1

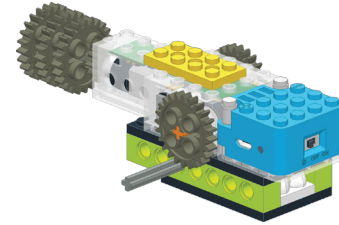

10

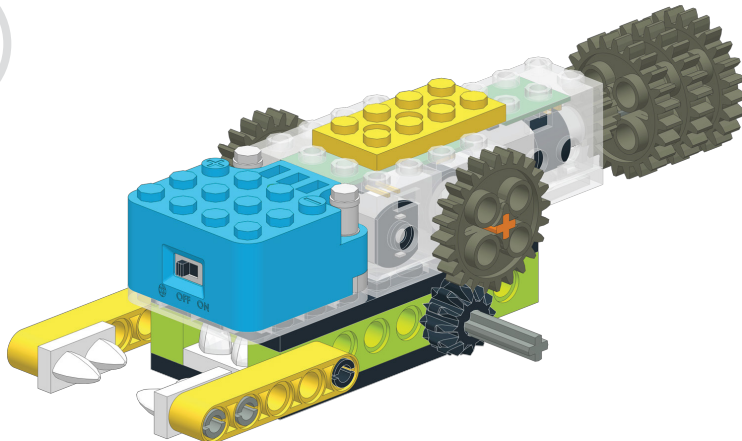

1

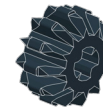

11

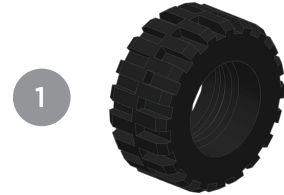
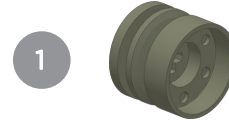
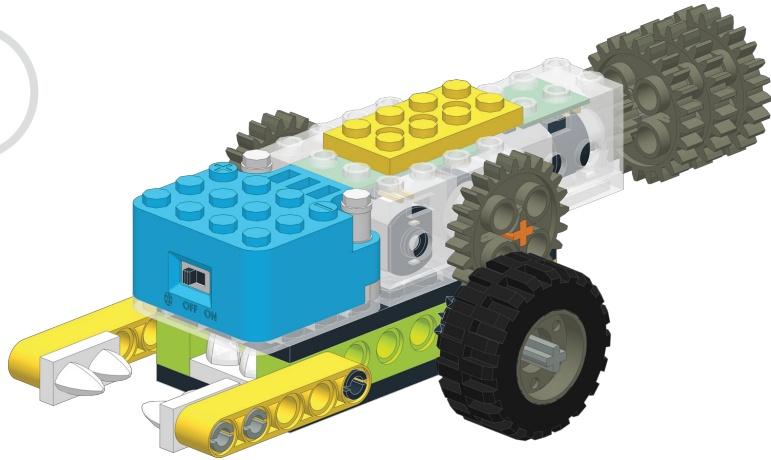

12

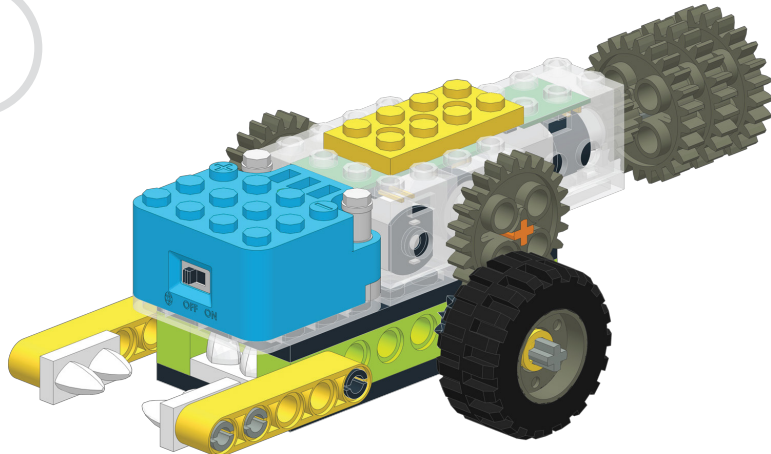

13

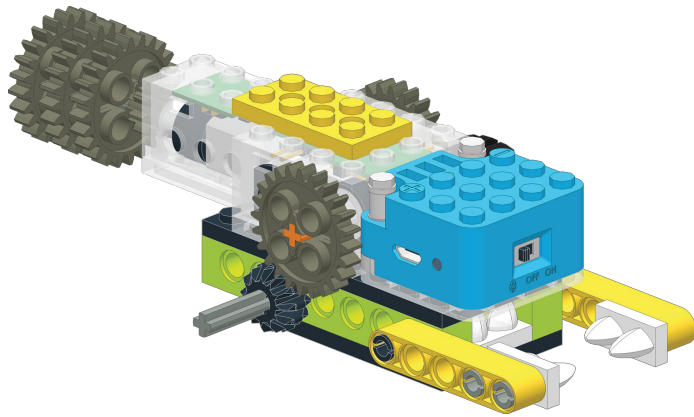

1

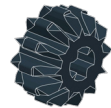

14

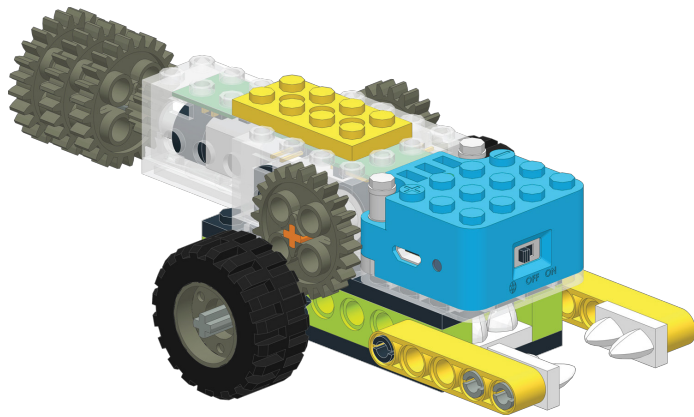

1

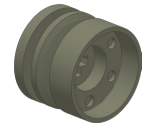

1





15

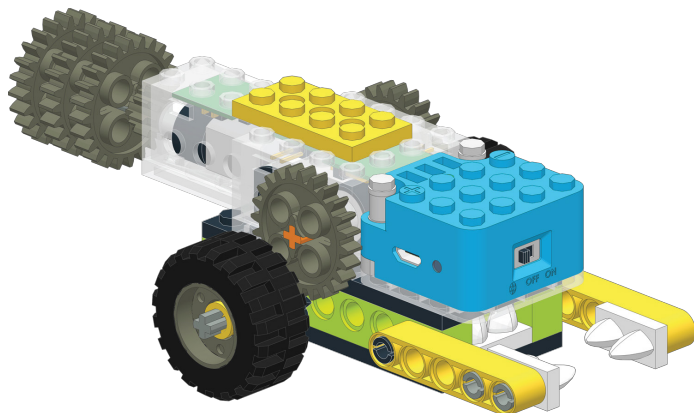

16

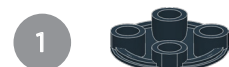

17

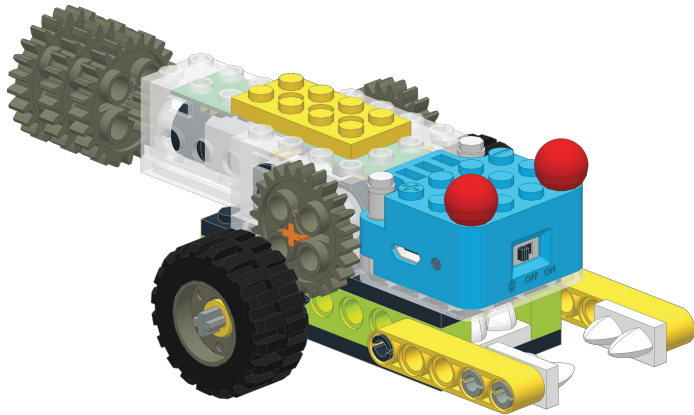

2



18

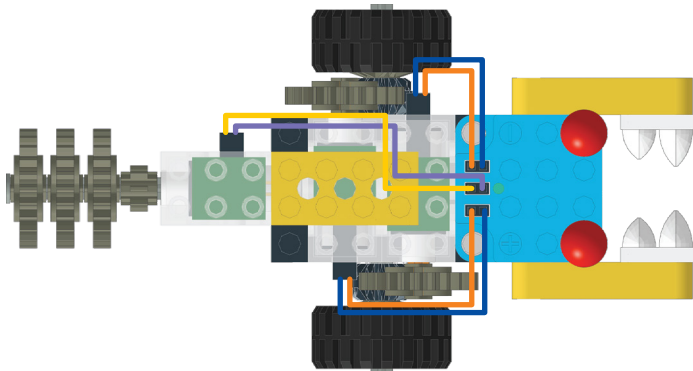

1

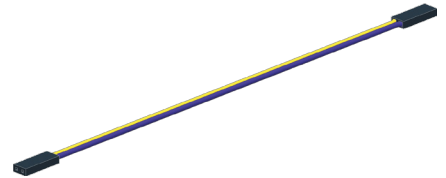

2



# *XM-A1 CONTROLS*

