

MaxShine[®]

All For Detailing

Maxshine HQ

📍 3rd. Floor, 1# Building, No.1 Fuyuan Road Jiujiang EDZ,
Wuhu, 241000 China

☎ +86 553 4996 266

✉ sales@maxshine.cn

🌐 [Http://www.maxshine.cn](http://www.maxshine.cn)

DETAILING HANDBOOK NO 2203

ABOUT US

Maxshine began 16 years ago with the idea that quality and durability must come first in the detailing industry.

With that in mind, we dedicated ourselves to designing and manufacturing the best long throw dual action polishers, pads, and a vast library of products that remain the best in the business to this day. With innovation leading our development in creating quality products, Maxshine has become a trusted brand in the detailing world; with distributors and product sales in more than 100 different countries and regions around the world.

Our dedicated and sincere love for the detailing industry will never change, no matter what circumstances surround us.

Founder

TABLE OF CONTENTS

PAGES	PRODUCT
1 - 8	Dual Action Polishers
9 - 13	Rotary Polishers and Backing Plates
14 - 22	Storage Solutions
23 - 30	Polishing Pads
31 - 39	Towels
40 - 45	Wash Mitts and Pads
46 - 50	Foam Applicators and Sand Paper
51 - 55	Clay Products
56 - 70	Detailing Brushes
71 - 94	Detailing Accessories

DUAL ACTION POLISHERS

Technical Data

Art.N°	Disc Size	Orbit	Rated Voltage	Input	Spindle Thread	No Load Speed
M8 Pro	125mm, 5"	15mm	220-240V AC	1000W/9A	5/16"-24	2600-6800/min
M15 Pro	125mm, 5"	15mm	220-240V AC	1000W/9A	5/16"-24	2200-5000/min
M15 Pro G	125mm, 5"	15mm	220-240V AC	1000W/9A	5/16"-24	2200-5000/min
M21 Pro	150mm, 6"	21mm	220-240V AC	1000W/9A	5/16"-24	2200-5000/min

Included: PU Hook & Loop Backing Plate, D Handle, Wrench, Carbon Brush, Manual.

Features

- Powerful 1000-watt motor, for fast and easy defect removal.
- Soft-start feature ensures no product sling.
- Ergonomically shaped, non-slip rubber grips on both the horn and handle make the machine a pleasure to use and hold.
- Speed control dial features large font, with a tactile "click" with each speed selection.
- Progressive trigger enables precise, variable, user-defined machine speed.
- Removable grills enable easy cleaning of debris and compound build-up from the inside of the machine.
- CNC-machined stainless-steel counterweight.
- Machine head features integrated heat dissipation technology.

1000W Long Throw Dual Action Polisher
ENHANCED POWER



550W Long Throw Dual Action Polisher ENHANCED PERFORMANCE



Features

- **POWERFUL ENGINE:** Maxshine's 12mm orbit 550W DA polisher improves efficiency and guarantees more power and torque on any surface.
- **ADVANCED SYSTEM:** Soft Start for easy use and application. Constant speed control and a CNC Machined Counterweight built in.
- **PERFECT BALANCE:** The perfect balance of the components makes polishing comfortable and vibration free. This ensures an optimum transfer of power to the surface, and makes even hard-to-reach spots accessible.
- **EXCELLENT POWER CORD:** 4m extension to strengthen the power cord.
- **IMPROVED SPEED CONTROL SYSTEM:** Adjustable speed dial from 2000 to 5500 oscillations per minute.

Technical Data

Art.N°	Disc Size	Orbit	Rated Voltage	Input	Spindle Thread	No Load Speed
M312	75mm, 3-3.5"	12mm	220-240V AC	550W/5A	5/16"-24	2000-5500/min

Included: PU Hook & Loop Backing Plate, Wrench, Carbon Brush, Manual.



Non-Slip, Rubber-Coated Grip

Self-locking On/Off Switch
Lock the power switch in place for constant power.

Speed Control Dial
Constant 6 speed variable control.



CNC-Machined Counterweight

INTRODUCING THE ALL NEW



Concave Rubber Contact Point
The concave rubber contact points absorb vibration and enhance control force.

Black Rubber Balance Block
Black rubber balance block is perfect balance of the components makes polishing comfort and efficiency, easy to place and not leaned.

External Carbon Brush
External carbon brush is beneficial to replace and use, save time and facilitate disassembly.

Head The Machine
The head shell of the machine is made of plastic instead of iron, which is light, convenient and easy to operate



1000W Powerful Dual Action Polisher

Technical Data

Art.N°	Disc Size	Orbit	Rated Voltage	Input	Spindle Thread	No Load Speed
M8S V2	125mm, 5"	8mm	220-240V AC	1000W/9A	5/16"-24	2500-6500/min

Included: PU Hook & Loop Backing Plate, Wrench, Carbon brushes, Handle.



Features

- **POWERFUL ENGINE:** Maxshine's NEW M8S 8mm 1000W Dual Action/DA Polisher has improved efficiency and guarantees more power and torque on any surface.
- **ERGONOMIC DESIGN:** The concave rubber contact points absorb vibration and enhance control. Exquisite design and soft-touch head cover makes your car detailing experience more comfortable and convenient.
- **PERFECT BALANCE:** Perfectly balanced internal components make this tool easy to operate, and eliminates strain on the user. The black rubber balance bar on top allows the user to rest the tool on any surface.
- **CONSTRUCTION:** The external carbon brush simplifies replacement without disassembly.
- **DESIGN:** The head shell of the machine is made of plastic instead of iron, which is light, convenient and easy to operate.



5" / 6" Foam Pads
 2071148G/ 2072148Y/ 2073148R
 2071170G/ 2072170Y/ 2073170R
 2031140G/ 2032140Y/ 2033140R
 2031165G/ 2032165Y/ 2033165R



5" / 6" Backing Pad
 3013125/ 3013150

MAXSHINE polisher accessories are designed to complement the M8S V2.

MN01 Cable: 1.5m Thread: M14

The MN01 is designed to be used in tight areas like car headlamps, fog lights, brake lights, door handles, emblems, glass, interior console panels and other small areas. The universal locking mechanism makes it extremely easy to lock-in all of your favorite accessories. Specifically designed for polishing small areas, the MN01 is proficient in gently removing debris, scratches and other surface imperfections on the recessed areas of your vehicles. A variety of mini-custom accessories are included that allow you to work on different surfaces. It comes ready to connect to a M14 connector - which are the industry standard outputs for rotary polishers.

EXCLUDED
RO POLISHER



INCLUDED

- Red Finishing Pad
Ø1.5x1cm (3pcs) Ø2.6x1.2cm (3pcs)
- Green Polishing Pad
Ø1.5x1cm (3pcs) Ø2.6x1.2cm (3pcs)
- Felt Polishing Pad
Ø1.5x0.5cm (3pcs)
- Long Wool Pad
Ø2.5cm (3pcs)
- Orange Polishing Pad
Size: 3x4.5cm (3pcs)
- Orange Polishing Pad
Size: 3x3cm (3pcs)
- Backing Pad
Ø1.5cm (1pc) Ø2.5cm (1pc)
- Adaptor M14 (1pc)
- Small Wrench (1pc)
- Small Bag (1pc)



MINI CORDLESS POLISHER

Description:

- The Maxshine Mini Cordless Polisher is a compact 12v cordless dual action machine polisher.
- This hand-held mini polisher can be used as a dual action or rotary polisher simply by swapping out the dual action module and attaching the backing plate directly to the head of the machine.
- Both 1.5" and 2" backing plates are included, as well as extension bars to help reach intricate areas.
- Enjoy continuous use with two 2300mAh battery packs provided, one can be used in the machine whilst the other is on charge, ensuring the polisher is always ready to use.
- The battery charger features an international battery charger also meaning it can be charged wherever you are in the world. and an LED display will show the battery life.

Features:

- 80W Mini Cordless Polisher, Rotary, 3mm, 12mm orbit DA polisher
- 3mm(counterweight set), 12mm(counterweight set) Dual Action Throw and Rotary
- 6 Speed Settings (2500 - 6000opm)
- Digital Screen for battery life
- 2 Batteries (2300mAh)
- 2" and 1.5" Backing Plates
- Extension Bars Included

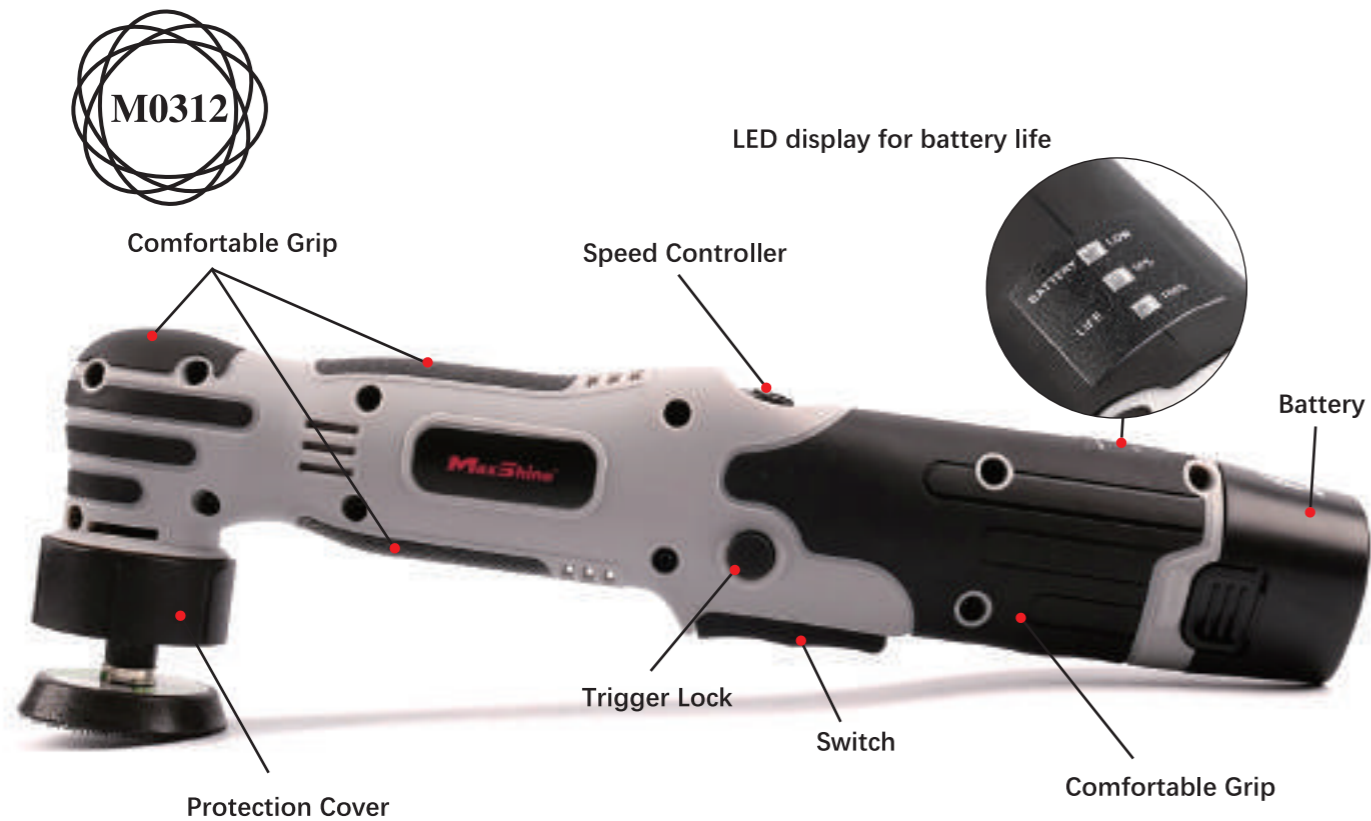

PACKAGE INCLUDING:



Hard Case with color box



Mini Cordless Polisher

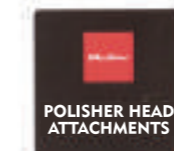

2300mAh 12v Battery (2pcs)

Polisher Head Attachments



Wrench (2pcs)



76.5mm Extension Bar



International Wall Charger

ROTARY POLISHERS

550W Rotary Polisher

Features

- **POWERFUL:** Maxshine has designed the M550 rotary with a highly-efficient, 550-watt motor to guarantee more power and torque on any surface, making your detailing experience easier and more efficient.
- **ADVANCED:** In the event of overheating, the M550 features an auto shut-off carbon brush to prevent motor damage. All ball bearings are sealed as well for a longer service life.
- **PERFECTLY BALANCED:** The internal components have all been designed and arranged to provide perfect weight distribution for polishing, taking stress off of the user.
- **POWER CORD:** A 4-meter (13") extension cord ensures free range of motion, while reinforcements around the base of the cord guarantee durability.
- **USER DEFINABLE SPEED CONTROL:** Adjustable speed from 1000 to 3500 rpm provides the user the ability to cut quickly and finish delicately.

Technical Data

Art.N°	Disc Size	Rated Voltage	Input	Spindle Thread	No Load Speed
M550	75mm, 3"	220-240V AC	550W/5A	M14	1000-3500/min

Included: PU Hook & Loop Backing pad, Wrench and Carbon brushes.

Best for spot polishing, very light!



1000W Rotary Polisher

Features

- **POWERFUL:** Maxshine has designed the M1000 rotary with a highly-efficient, 1000-watt motor to guarantee more power and resistance to stalling.
- **ADVANCED:** In the event of overheating, the M1000 features an auto shut-off carbon brush like the M550 to prevent motor damage. All ball bearings are sealed as well for a longer service life.
- **PERFECTLY BALANCED:** The internal components have all been designed and arranged to provide perfect weight distribution for polishing, taking stress off of the user.
- **POWER CORD:** A 4-meter (13") extension cord ensures free range of motion, while reinforcements around the base of the cord guarantee a long service life.
- **USER DEFINABLE SPEED CONTROL:** Adjustable speed from 800 to 3300 rpm provides the user the ability to cut quickly and finish delicately.



Technical Data

Art.N°	Disc Size	Rated Voltage	Input	Spindle Thread	No Load Speed
M1000	125mm, 5"	220-240V AC	1000W/9A	M14	800-3300/min

Included: PU Hook & Loop Backing Plate, Wrench, Carbon Brush, Manual, Handle, Side Handle.

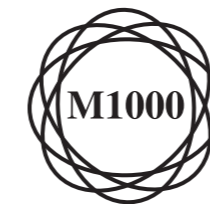

MAXSHINE accessories are designed to complement M1000



5" RO Backing Pad
3071125

BACKING PLATES

DA POLISHER BACKING PAD

Flexible and durable in design, the Maxshine Dual Action Polisher Backing Plate is made from high quality materials to ensure the user has a comfortable experience while polishing. With a thick cushioning foam interface, the Dual Action Backing Plates will ensure paint safety and consistent polishing results time after time. With built in cooling passages, the backing plate will keep pads and machines cooler for longer and the hook and loop backing plate material grips to all pad types, ensuring pads stay centered and balanced.



3013125 5" (125mm)
Max OPM: 12000 Thread: 5/16"-24 Hole: 6



3013150 6" (150mm)
Max OPM: 12000 Thread: 5/16"-24 Hole: 6

PRO SERIES

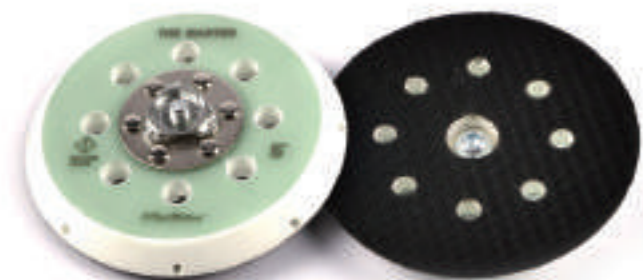

3011125 5" (125mm)
Max OPM: 12000 Thread: 5/16"-24 Hole: 8



3011150 6" (150mm)
Max OPM: 12000 Thread: 5/16"-24 Hole: 8



Designed to complement M15 Pro & M21 Pro polishers

3" DUAL ACTION BACKING PAD



3013070 3" (70mm)
Max OPM: 12000 Thread: 5/16"-24



Designed to complement M312 polisher

RO POLISHER BACKING PAD

5" ORIGINAL RO POLISER BACKING PAD

3071125 (M14) 5" (125mm)

Max OPM: 12000

MATERIAL: Imported PU with soft edge which protects the painted surface.

Flexible and durable in design, the Maxshine rotary polisher backing plate is made from high quality materials to ensure the user an even, comfortable feel while polishing. With a thick cushioning foam interface, the Maxshine rotary backing plate will ensure safety and consistent polishing results.



Designed to complement M1000

3051075 (M14) 3" (75mm)

3051125 (M14) 5" (125mm)

3051150 (M14) 6" (150mm)

3051178 (M14) 7" (178mm)

Max OPM: 12000

MATERIAL: Imported PU with soft edge which protects the painted surface.

Shaped by injection moulding with high elasticity and durability.

Suited for high speed polishing with high temperature resistance.

Recommended for polishing small intricate areas with a RO polisher.



STORAGE SOLUTIONS

Maxshine's Storage Solutions are an exceptional addition to any garage or mobile detailing set up. The unique, durable construction is capable of mounting large/small Dual Action and Rotary Polishers. For added function, our polisher holders come equipped with a storage compartment to hold power cords and keep them off the ground.

H01 SINGLE STATION

Size: 7.5 x 25 x 3in
MADE OF QUALITY IRON



H01M SINGLE STATION

GOOD FOR MOBILE VAN

Size: 9 x 17 x 3in
MADE OF QUALITY IRON



H02 DOUBLE STATION

Size: 14 x 25 x 3in
MADE OF QUALITY IRON



H02M DOUBLE STATION

GOOD FOR MOBILE VAN

Size: 14 x 17 x 3in
MADE OF QUALITY IRON



FOAM PADS HOLDER

The Maxshine Foam Pad Holder holds various size foam pads and is constructed with High Quality Iron to ensure that it is built to last and is resistant to rust. High Corrosion Resistance keeps your pad holders looking new for years to come!

Upgrade your garage and mobile detailing setup with our systematic Pad Holders.

H04M

3" Foam Pads Holder
Dia: 105mm Height: 205mm



H05M

5" Foam Pads Holder
Dia: 160mm Height: 205mm



H06M

6" Foam Pads Holder
Dia: 180mm Height: 205mm

SPRAY BOTTLE AND COMPOUND HOLDER

Quickly store and organize your spray bottles and compounds for efficient detailing on the go or in your garage!



H03H SUITABLE 32OZ & 16OZ BOTTLE



Length: 540 mm Width: 190 mm
High: 185 mm Material: Iron 5 Holes
MADE OF QUALITY IRON

H03BH SUITABLE 16OZ BOTTLE



Length: 464 mm Width: 100 mm
High: 170 mm Material: Iron 5 Holes
MADE OF QUALITY IRON

H03EH 34 OZ IK TRIGGER SPRAYER HOLDER SUITABLE FOR IK HAND SPRAY



Length: 540 mm Width: 135 mm
High: 200 mm Back height: 11cm
MADE OF QUALITY IRON



MULTIFUNCTIONAL HOLDER

Store multiple tools and chemicals in one place, with space for brushes and bottles. Keep your area organized and looking professional with the Brush and Trigger Bottle Holder.

The Perfect Addition to Your Garage.



H06

Length: 410 mm
Width: 55mm
High: 240 mm
Material: Iron 10 Holes
MADE OF QUALITY IRON

SPRAY BOTTLE HANGER

Maxshine's ALL-NEW Trigger Bottle Holder is the simplified, space-saving companion to the Trigger and Brush Holder. Featuring 3 extended slots to place anywhere from 5 to 6 Bottles at a time, keeping them organized and safe from damage and cracking.

Features:

- 3 Trigger Slots-Holds 5-6 Spray Bottles
- Durable Iron Construction
- High Corrosion Resistance
- Corresponding Screws Included



H03D

PHONE AND HEADPHONE HOLDER



H11

Tired of carrying your phone, wallet, keys, and headphones around the garage? Well, Maxshine has you covered! Match the style of your Maxshine Storage Solutions with the All New Maxshine Phone and Headphone Holder. Mounts easily and securely to the wall and helps keep you organized and stylish!

Size:121 x 89 x 217mm
Maximum Weight: 3.3lbs



DETAILING BRUSH HANGER

The ALL-NEW Maxshine Detailing Brush Holder is the next innovative solution in our line of Storage Solutions. Featuring 6 Hooks attached at the base, this Brush Holder is capable of holding an entire fleet of brushes to keep your detailing accessories close and easily accessible! Works great with Brushes, Telescopic Poles, Rakes, Leaf Skimmers, Vacuum Hoses, etc. Keeping your brushes hung assists in the prevention of damaged bristles and contamination, keeping them in working shape and saving you money on replacements!



H06B

DETAILING BRUSH HOLDER

The Ultimate Solution to complement our Trigger Bottle and Brush Holder.

Store up to 10 Brushes at a time in a sturdy, stylish, and sleek designed organizational holder!

Features:

- Iron Construction
- Wall Mount with Screws Provided
- No Assembly Required
- Sleek Design



H06A

CERAMIC COATING HOLDER

The ALL-NEW Ceramic Coating Holder allows users to place bottles and product on walls, vans, and anywhere your detailing business is conducted! Discover new efficient ways to keep your jobs running smoothly and prevent leaks and wasted materials in the process!

Features:

- Wall Mount with Screws
- Easy Mount
- Iron Construction
- Designed to Hold 50ml-100ml Bottles



H03C

FOAM CANNON HOLDER

Perfectly designed for optimal organization and style, the Foam cannon holder will upgrade any garage or mobile detailing set-up. Prevent spills and leaks with style!

Size: 39X18cm

Suitable for 1/4 inch plug, 1/4" Quick Connect



H08A

GLOVE BOX HOLDER

Keep your gloves right where you need them. This Glove Box Holder will keep your space clean and organized. It's the perfect accessory for any industry where gloves are used regularly.

Features:

- Made of high-quality resistant steel
- Powder coating finish to provide additional protection against oxidation.
- Designed to fit most sized boxes of gloves.
- Keep your gloves right where you need them.
- Easy wall mounting installation



H13

SNOW MASTER FOAM CANNON HOLDER

Perfectly designed for optimal organization and style, the Snow Master Foam Cannon Holder will upgrade any garage or mobile detailing set-up.

Size: 120 x 120 x 175mm
Compatible with SMFC002

H08



FOAM CANNON BUCKET MOUNT

Foam Cannon Mount allows you to attach your Maxshine Snow Master or Lance Foam Cannons to your wash bucket. Keep all your detailing products together and organized while washing your vehicle.

Size: 60 x 91 x 82mm
Compatible with SMFC001 & SMFC002

H09



HIGH PRESSURE SPRAY GUN HOLDER

Keep your pressure washer gun handy with its own wall-mounted holder. A perfect upgrade to any garage or mobile detailing setup.

H10



WHEEL & TIRE DETAILING STAND



Cleaning, polishing, and protecting your heavy car and truck wheels has never been more efficient or effective than now. Introducing Maxshine's Wheel Stand Tire Roller; by removing the wheels from the vehicle and placing them on the durable and easy-to-roll rail system, you can reduce strain on your body and place the wheel at any comfortable level to ensure simple and effective detailing evenly across the surface.

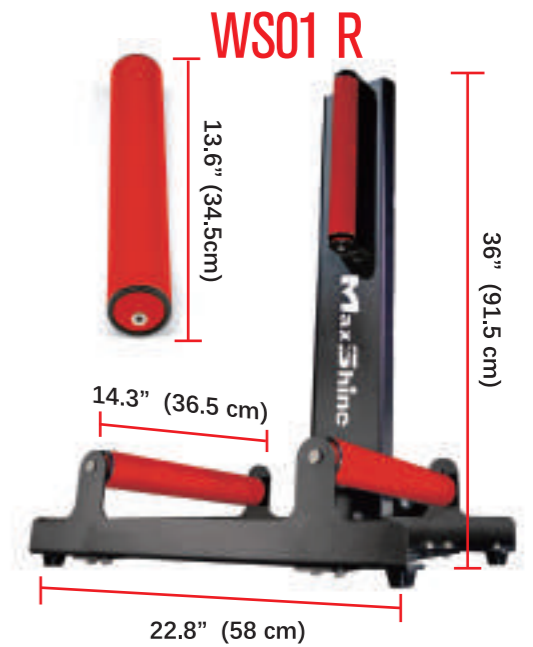
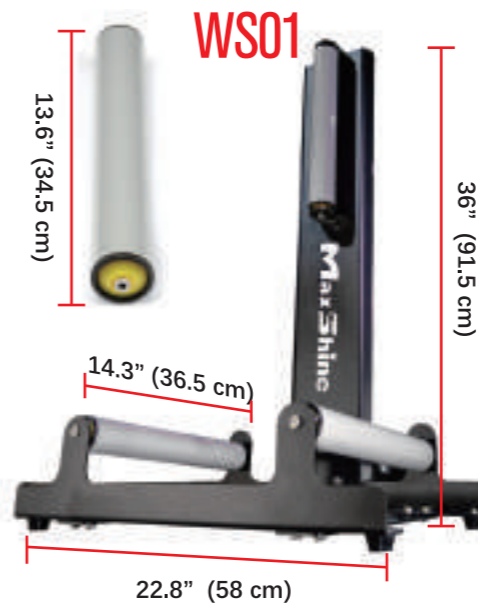

FOAM POLISHING PADS

PAINT REFINISHING SYSTEM

Features

- Center cut heat dispersion hole.
- High strength hook and loop backing material and high heat resistant backing adhesive.
- Non-shred, easy to clean.
- Small angled edge design to simplify accurate polishing around the edges of panels.

CROSS CUT FOAM PADS

CUTTING PAD	POLISHING PAD	FINISHING PAD	SIZE
2001090G	2002090Y	2003090R	80-90X25mm (3")
2001135G	2002135Y	2003135R	125-135X25mm (5")
2001160G	2002160Y	2003160R	150-160X25mm (6")
Green Foam with Black Velcro	Yellow Foam with Black Velcro	Red Foam with Black Velcro	



LOW-PRO DA FOAM PADS

CUTTING PAD	POLISHING PAD	FINISHING PAD	SIZE
2071148G	2072148Y	2073148R	125-148X(6+12)mm (5")
2071170G	2072170Y	2073170R	150-170X(6+12)mm (6")
Green Foam+EVA with Black Velcro	Yellow Foam+EVA with Black Velcro	Red Foam+EVA with Black Velcro	



FLAT FOAM PADS

CUTTING PAD	POLISHING PAD	FINISHING PAD	SIZE
2031085G	2032085Y	2033085R	75-85X25mm (3")
2031140G	2032140Y	2033140R	130-140X25mm (5")
2031165G	2032165Y	2033165R	155-165X25mm (6")
Green Foam with Black Velcro	Yellow Foam with Black Velcro	Red Foam with Black Velcro	



THIN ALL PURPOSE FOAM PADS

HEAVY CUTTING PAD	CUTTING PAD	POLISHING PAD	FINISHING PAD	SIZE
2020148G	2021148B	2022148Y	2023148R	130-148X20mm (5")
2020165G	2021165B	2022165Y	2023165R	150-165X20mm (6")
Green Foam with Black Velcro	Blue Foam with Black Velcro	Yellow Foam with Black Velcro	Red Foam with Black Velcro	



HIGH-PRO DA FOAM PADS

HEAVY CUTTING PAD	CUTTING PAD	POLISHING PAD	FINISHING PAD	SIZE
2020155G	2021155B	2022155Y	2023155R	130-150X30mm (5")
2020175G	2021175B	2022175Y	2023175R	155-175X30mm (6")
Green Foam with Black Velcro	Blue Foam with Black Velcro	Yellow Foam with Black Velcro	Red Foam with Black Velcro	

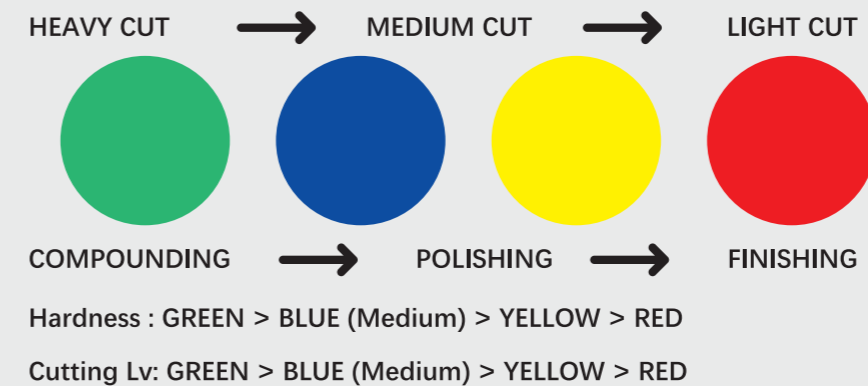

NOTE

Higher Cutting Levels
Determine The Intensity and
Ability to Remove Scratches,
Defects or Oxidation!

AIO FOAM PADS (ONE-STEP CORRECTIONS)

- 20911300 (5") Ø130-145x25mm
- 20911500 (6") Ø150-165x25mm

Maxshine AIO Foam pad is suited for one-step corrections, applying waxes and sealants. This foam was chosen for its perfect balance of cutting and polishing.



Maxshine Foam Pads are designed to work flawlessly with other Maxshine products!

MINI FOAM POLISHING KIT

The Mini Foam Polishing Kit simplifies cutting and buffing on oxidized surfaces in hard-to-reach areas. Remove fine scratches and swirls from painted surfaces that are caused by improper washing and drying techniques. These small pads are an essential tool for small, detailed areas around the vehicle, including near fragile emblems and surfaces.

2040001

1" Mini Foam Polishing Kit
Plate Backing Pad: 1"
Wool Pad : Ø40mm
Green Cutting Foam Pad
Yellow Polishing Foam Pad
White Finishing Foam Pad: Ø32x15mm



2040002

2" Mini Foam Polishing Kit
Plate Backing Pad: 2"
Wool Pad : Ø56mm
Green Cutting Foam Pad
Yellow Polishing Foam Pad
White Finishing Foam Pad: Ø52x20mm



2040003

3" Mini Foam Polishing Kit
Plate Backing Pad: 3"
Wool Pad : Ø80mm
Green Cutting Foam Pad
Yellow Polishing Foam Pad
White Finishing Foam Pad: Ø76x25mm



2050001

1" Foam Polishing Kit
Green Cutting Foam Pad (2 pcs)
Yellow Polishing Foam Pad (2 pcs)
White Finishing Foam Pad (2 pcs)
Ø32x15mm

6pcs/ pack



2050002

2" Foam Polishing Kit
Green Cutting Foam Pad (2 pcs)
Yellow Polishing Foam Pad (2 pcs)
White Finishing Foam Pad (2 pcs)
Ø52x20mm

6pcs/ pack



2050003

3" Foam Polishing Kit
Green Cutting Foam Pad (2 pcs)
Yellow Polishing Foam Pad (2 pcs)
White Finishing Foam Pad (2 pcs)
Ø76x25mm

6pcs/ pack



ORANGE PEEL REMOVAL PAD

2000 GRIT BLACK DENIM PAD

The Maxshine Black Denim Pad utilizes a unique, aggressive denim material to offer maximum leveling power. This pad is designed to remove heavy orange peel from resprayed (thick) paint systems.



2pcs/ pack

2071080P Ø80mm

2071135P Ø135mm



3000 GRIT PURPLE VELVET PAD

The Maxshine Purple Velvet pad uses a roped, corduroy velvet that is less aggressive than the Maxshine Denim Pad. This pad is designed to remove orange peel from OEM (thin) paint systems.



2pcs/ pack

2072080P Ø80mm

2072135P Ø135mm



FOAM INTERFACE PAD

Designed for in-between and final sanding involving finer grain. Does not work with interface for rough sanding involving coarse grain and when using sanding fleece.

3090075 Ø75mm (no hole)

3099125 Ø125mm (8+1 holes)

3099150 Ø150mm (8+1 holes)

Made with extra-soft foam layer.



WOOL POLISHING PADS

WOOL CUTTING PAD

Knitted Wool Pads are made from 100% Wool, with strategic manufacturing techniques that produce consistent fiber thickness, height, and density. This technique allows Maxshine Wool Pads to maintain their shape and produce less lint and debris. Premium performance and heat-resistant construction allows the user to perform aggressive scratch and swirl removal while leaving a glossy finish.

Options:

1. Bevel Edge(Popular)
2. Straight Edge.



2061080R Ø80x(6+8)mm

2061125R Ø125x(6+8)mm

2061150R Ø150x(6+8)mm

100% Wool

GLASS WOOL POLISHING PAD

The Maxshine Glass Wool Polishing Pad provides a flat, textured surface to effectively level scratches and imperfections without leaving a distorted finish. The textured surface allows for faster cutting and efficient, effective results every time. Conveniently attach to a variety of tools based on user preference.

2065080 Ø80x5mm

2065130 Ø130x5mm

2065150 Ø150x5mm

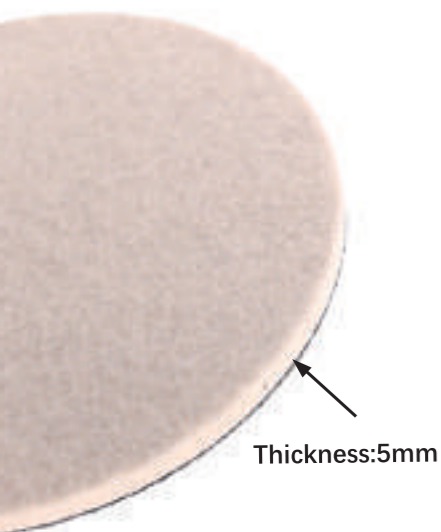

PREMIUM WOOL CUTTING PAD



Made from 100% Natural Wool, this Premium Wool Cutting Pad uses a strong adhesive to secure wool to the backing of the pad, ensuring less lint and debris on your surface. Excellent cutting & polishing results that remove heavy defects and imperfections.

2063080 Ø80mm 2063125 Ø125mm

2063150 Ø150mm

100% Wool



WOOL CUTTING PAD

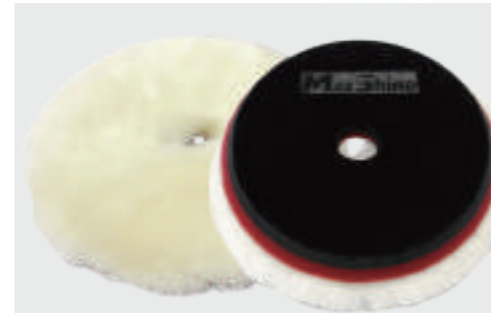

The Maxshine Wool Cutting Pad is the standard pad design, capable of resisting chemical-based corrosion and providing a heat-resistant breathable foam backing. Made from specifically selected Wool directly from Australia, and the highest quality EVA Foam material to prevent damage to the surface and stabilize the polishing process. For best results, match with Maxshine Compounds and Polishing tools.

2064075R Ø78-90x(6+6)mm 2064125R Ø125-150x(6+6)mm 2064150R Ø150-170x(6+6)mm

SYNTHETIC WOOL CUTTING PAD

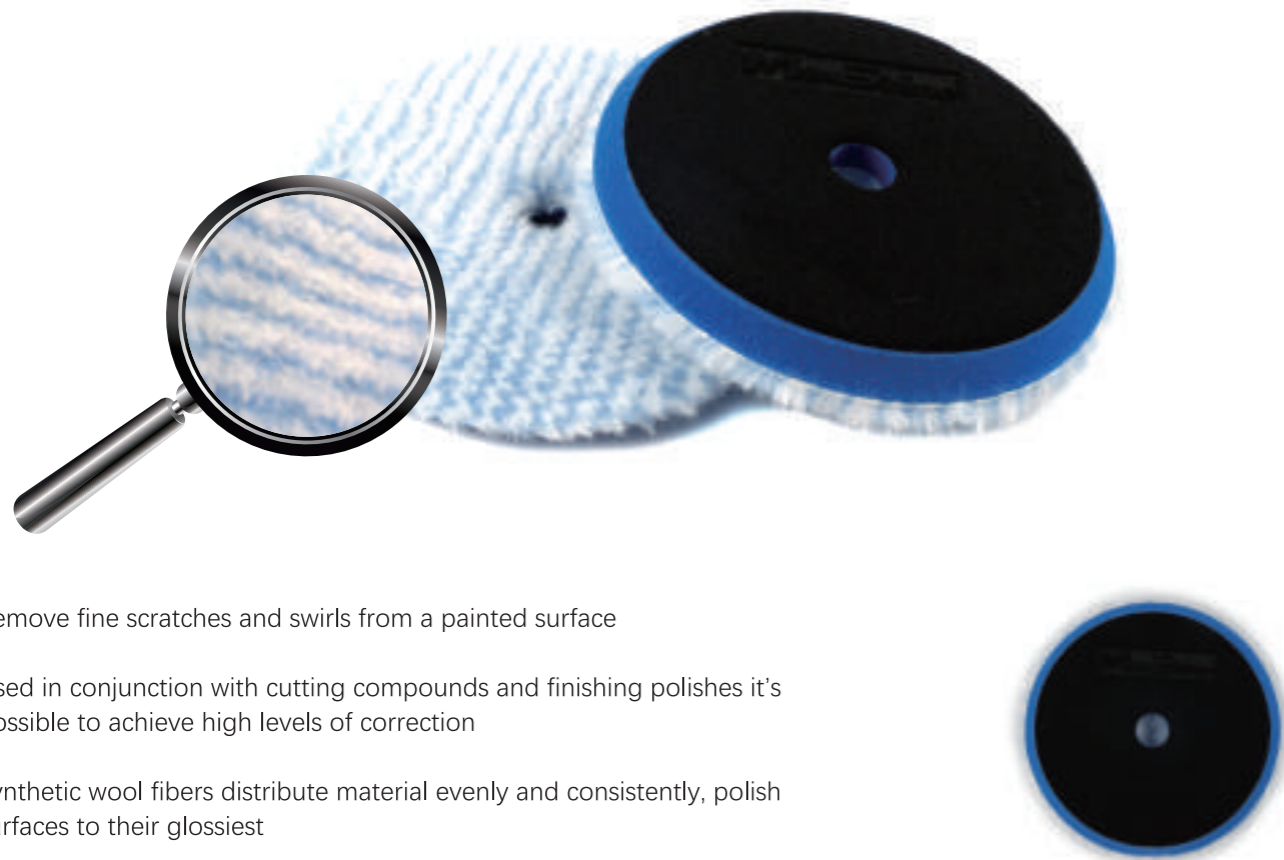

Remove fine scratches and swirls from a painted surface

Used in conjunction with cutting compounds and finishing polishes it's possible to achieve high levels of correction

Synthetic wool fibers distribute material evenly and consistently, polish surfaces to their glossiest



- 2052080B** (3") Ø 78-90x10mm
- 2052130B** (5") Ø 130-146x12mm
- 2052150B** (6") Ø 150-165x12mm

Material: Blue Foam with Black Velcro

MICROFIBER DA PADS



Designed for compatibility with Dual Action Polishers to remove swirl marks and scratches from painted surfaces. The Dual Action Microfiber System is an innovative development in the paint correction process.



Cutting

- 2051080B** (3") Ø 80x10mm
 - 2051130B** (5") Ø 130x10mm
 - 2051155B** (6") Ø 155x10mm
- Blue Foam With Black Hook & Loop



Finishing

- 2053080R** (3") Ø 80x10mm
 - 2053130R** (5") Ø 130x10mm
 - 2053155R** (6") Ø 155x10mm
- Red Foam With Black Hook & Loop



Heavy Aggressive



- 2050125BL** (5") Ø 125-145x(6+8)mm
 - 2050150BL** (6") Ø 150-170x(6+8)mm
- (Red Foam + Black EVA) With Black Microfiber

Designed for compatibility with Maxshine Dual Action Polishers.

EXTREME PREMIUM MICROFIBER TOWEL

A true Detailing Routine is not complete without proper steps to ensure no scratches or swirls are left behind. Premium Microfiber Towels & Applicators are the finest available and reduce chances of leaving behind imperfections that will add to the workload later. Easy to use, and safer than the rest!



VORTEX TOWEL

Maxshine Vortex is designed for a faster, more thorough dry than conventional drying towels. Extra soft and absorbent, it gently and quickly wicks away moisture while also quick drying between uses.

1166090G 24"x 36" (60x90cm)
Green
Thickness: 1000gsm

1165060G 20"x 24" (50x60cm)
Green
Thickness: 1000gsm



1200GSM DUO TWISTED COLORFUL TOWEL

Maxshine Duo Twisted Colorful Towel is specially designed for achieving the best results in drying. "Duo" comes from the unique twist-loop material being applied to both sides of the towel. This technique as well as the 1200g/m² thickness provides strong absorption allowing for faster, more thorough drying.

1176090GP 24"x 36" (60x90cm)
Pink+Grey
Thickness: 1200gsm

1175060GP 20"x 24" (50x60cm)
Pink+Grey
Thickness: 1200gsm



DUO TWISTED LOOP DRYING TOWEL



The Maxshine Duo Twisted Loop Drying Towel is by far the best drying towel available in the market today. These towels are made with unique, ultra-soft microfiber material that holds up under multiple uses and is structured to ensure the absorption of a large amount of water. Featuring rounded corners and microfiber material from end to end, this towel holds up as one of the best, and is now available in 2 sizes!

1196090P
24"x 36" (60x90cm)
Purple
Thickness: 1200gsm

1195060P
20"x 24" (50x60cm)
Purple
Thickness: 1200gsm



SINGLE TWISTED LOOP DRYING TOWEL

Offering the highest level of shine with any heavy task, the Maxshine 600GSM Single Purple Twisted Loop Drying Towel is the perfect alternative to its counterpart, the Duo Twisted Drying Towel. Great at removing grime from the exterior, as well as cleaning any interior. Reusable and Machine Washable, with an Eco-Friendly construction!

1pc/ pack

1186090P 24"x 36" (60x90cm)
Purple
Thickness 600gsm

3pcs/ pack

1184040P 16"x 16" (40x40cm)
Purple
Thickness 600gsm



EDGELESS ULTRA PLUSH 500GSM MICROFIBER TOWEL

The Maxshine Edgeless Ultra Plush 500GSM Microfiber Towels are the perfect solution for waterless washes and quick detailing when multiple towels are needed. The Ultra Soft fibers pull particles away from the surface as they are wiped, preventing scratches and swirl marks. Rated at 500GSM, these towels are the perfect way to stock up on limitless towels for your washes.

Blend: 70% Polyester / 30% Polyamide.

Border / Edging: Edgeless Knife-Cut.

Material Weight: 600 GSM (Grams per Square Meter).

3pcs/ pack

10104040G 16"x 16" (40x40cm)

10104060G 16"x 24" (40x60cm)



3pcs/ pack

10104040O 16"x 16" (40x40cm)

10104060O 16"x 24" (40x60cm)



DRYING MICROFIBER TOWEL

Blend: 80% Polyester / 20% Polyamide.

Border / Edging: Black Silk-Lined Border.

Material Weight: 800 GSM (Grams per Square Meter).

1pc/ pack

1014040W 16"x 16" (40x40cm)



GLASS CLEANING 300GSM MICROFIBER TOWEL

The Maxshine Glass Cleaning Towel features a low pile that is ideal for cleaning windows, mirrors, and chrome. Extremely tight weaving grabs onto oils, dust, dirt, and other debris to leave a flawless shine on the finished product. No more fingerprints and dirt!

Blend: 80% Polyester / 20% Polyamide.

Border / Edging: Green Sewn Border.

Material Weight: 300 GSM (Grams per Square Meter).



5pcs/ pack

1094040G 16"x 16" (40x40cm)



"BIG RED" MICROFIBER DRYING TOWEL

"Big Red" Microfiber Drying Towel is next in line as one of the best drying towels on the market. The waffle-weave construction traps water more efficiently than standard, low GSM, towels available, and can be used multiple times. It can absorb over 7 times its weight in water, and a single towel can dry an entire car in one pass!

Blend: 80% Polyester / 20% Polyamide.

Border / Edging: Red Border.

Material Weight: 1000 GSM (Grams per Square Meter).



1085070R 20"x 28" (50x70cm)

DRYING 1000 MICROFIBER TOWEL



Black silk border



1pc/ pack
10640400
16"x 16" (40x40cm)

The Maxshine Drying 1000 Microfiber Towel is the most recent advancement in common microfiber towels, with an undated thickness and the ability to hold far more water than its counterparts. The high pile pulls dirt away from surfaces, preventing scratches and leaving a delightful finish. Features 1000 GSM microfiber with a deep pile surrounded by a bold silk border.

Blend: 80% Polyester / 20% Polyamide.
Border / Edging: Black Silk-Lined Border.
Material Weight: 1000 GSM (Grams per Square Meter).

GLASS "CLEAN AND DRY" MICROFIBER TOWEL



3pcs/ pack
1043535W
14"x14" (35x35cm)

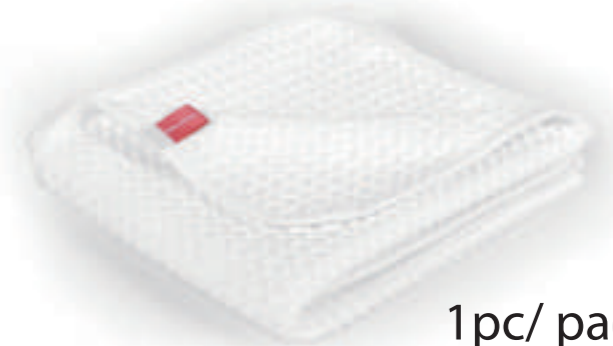

1pc/ pack
1046090W
24"x36" (60x90cm)

The Clean and Dry Glass Microfiber Towel is the ultimate towel for efficient glass cleaning. Streaks and residue are a thing of the past, with the all new glass towel featuring 400GSM and a tightly woven fabric that makes wiping away oily fingerprints and dirt simple and easy.

Blend: 80% Polyester / 20% Polyamide.
Border / Edging: White Border.
Material Weight: 400 GSM (Grams per Square Meter).

GENERAL PURPOSE MICROFIBER TOWEL

General Purpose Towels are commonly found in Car Care Products, but quality makes all of the difference! Featuring a double-sided medium pile, and high absorbency material, these towels are the perfect tool to keep nearby during a detail or simply to have around the house. Looped fibers make picking up dust, dirt, wax residue and more, a simple task.

Blend: 80% Polyester / 20% Polyamide.
Border / Edging: Edgeless Knife-Cut.
Material Weight: 330 GSM (Grams per Square Meter).



5pcs/ pack
1104040B 16"x 16" (40x40cm)
1104060B 16"x 24" (40x60cm)



SOFT CARBON FIBER TOWEL

The Soft Carbon Fiber Towel offers the highest-level shine under any task. Designed to clean difficult exteriors and removing dirt and grime build up on interiors. Safe and usable on clear coats and can be used multiple times with proper care. This towel truly does it all, and even features 360GSM, making it easy to pick up liquids if needed!

Blend: 67% Polyester / 18% Carbon Fiber/ 15% Nylon.
Border / Edging: Dark Grey with Red Silk Border
Material Weight: 360 GSM (Grams per Square Meter).

SAFE ON CLEAR COATS

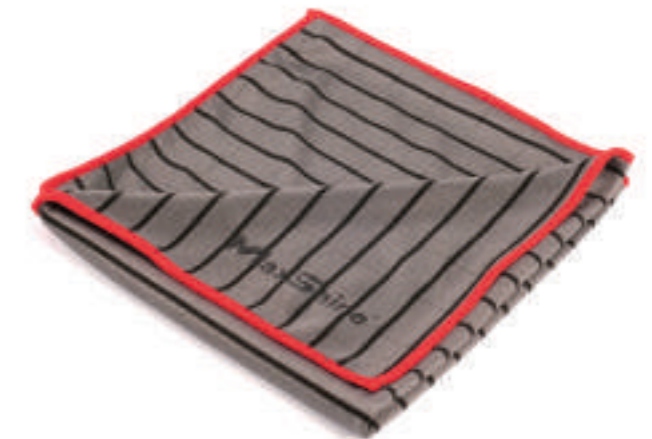

3pcs/ pack
1034040G
16"x16" (40x40cm)

SHAMMY PVA MESH TOWEL

Shammy Mesh Towel is the vastly superior alternative to terrycloth towels, with a uniform sponge-like pore structure. Capable of holding water for more than 4 hours, this towel is the perfect sidekick for any detailer looking to dry a vehicle in no time at all.

1pc/ pack

1106643G
26"x 17" (66x43cm)



COMPOUND REMOVAL MICROFIBER TOWEL

The Compound Removal Towel features a closed-loop construction designed for wiping away polish and wax residue. Soft fabric and non-stitched edges make it safe for using on most delicate surfaces with no scratches left behind!

Blend: 80% Polyester / 20% Polyamide.
Border / Edging: Edgeless Knife-Cut.
Material Weight: 350 GSM (Grams per Square Meter).

3pcs/ pack

10504040R
16"x 16" (40x40cm)

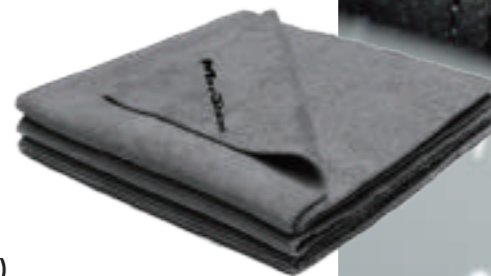

MICROFIBER EDGELESS UTILITY TOWEL

Edgeless Utility Towels offer high value durability and absorption for minimal cost, allowing you to utilize them without the guilt of ruining high value towels. The tight, densely woven 260GSM microfiber material is extremely absorbent, and make general purpose cleaning a breeze! Use them on the toughest, dirtiest jobs, or to generally wipe down surfaces after spills and applications.

50pcs/ pack

1103030G
12"x 12" (30x30cm)



POLISH REMOVAL TOWEL

These Polish Removal Towels are constructed of a unique super-soft, long lasting microfiber material. They have high water absorption and are scratch-free, lint-free, and swirl-free. With their medium pile they can be used effectively both wet and dry.

5pcs/ pack

1240405Y-SET 16"x 16" (40x40cm)
1240605Y-SET 16"x 24" (40x60cm)

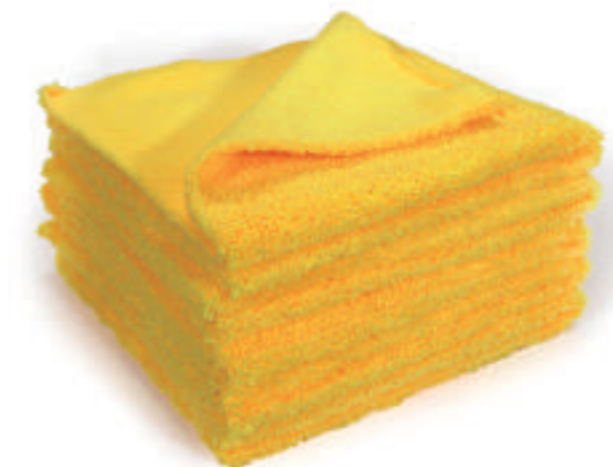

SUEDE COATING CLOTH

The small and convenient suede microfiber detailing coating cloth is resistance to wash induced marring, bird dropping damage, stains, high or low temperatures, and traffic film. The used coating cloth must be cleaned before coating again.

10pcs/ pack

1101010G
4"x 4" (10x10cm)

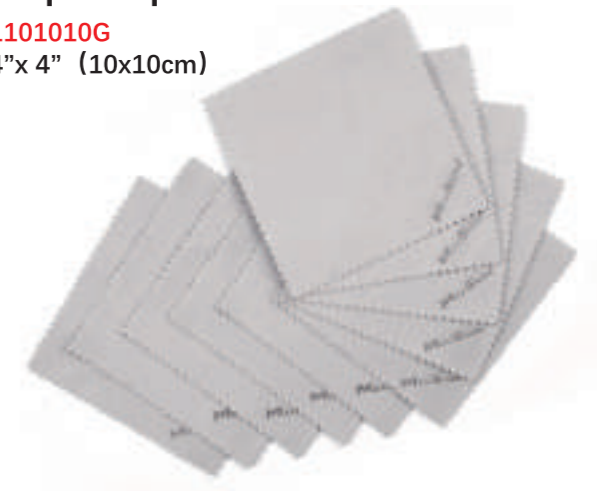

REUSABLE DETAILING MICROFIBER TOWELS WITH DISPENSER BOX

180GSM

- Contains 20 soft cleaning cloths
- Safe to use on any surfaces; streak-free and scratch-free
- Perfect for many detailing tasks
- Can be used for general cleaning, easily replaces disposable paper towels
- Machine washable
- Dispenser box is compatible with Maxshine's Glove Box Holder (H13)

1102222G

Size: 8.66 x 8.66 inches (22x22cm)

Thickness: 180g/m²

Material: 70% polyester, 30% polyamide

20 cloths/box



WOOL WASH MITTS

PREMIUM SHEEPSKIN WOOL MITT

Made from the very same Australian Merion wool as our wool pads, this mitt features a very dense pile, making it ideal for every wash! Durable, easy to clean, and great absorption makes this wash mitt virtually unbeatable in the prevention of scratches.

Not Machine Washable. Rinse and Air Dry.

8011005 Size: 24x15x4cm



LAMBSWOOL WASH MITT

Made from Ultra Soft Lambswool with a natural hide backing. The dense pile featured on this mitt makes it ideal for any wash and prevents scratching from beginning to end. Easily remove dirt and dust from your vehicle and enjoy the freedom of the attached thumb design making comfort and function a priority!

Not Machine Washable. Rinse and Air Dry.

8011003 Size: 32x19cm



LAMBSWOOL WASH MITT

Made from the super-soft wool with natural hide backing as most sheepskin mitts it consists of a very dense soft pile, making it an ideal wash mitt. Sheepskin wash mitts make the perfect choice for washing your vehicle. this wash mitt will not scratch paint.

8011004 Size: 16x24cm



LAMBSWOOL WASH PAD

Made from the same Ultra Soft Lambswool as the Lambswool Mitts, the dense pile featured on this Pad makes it ideal for any wash. Easily removes dirt and dust from your vehicle without scratching or damaging the surface.

Not Machine Washable. Rinse and Air Dry.

8011002 Size: 23x23cm



MICROFIBER WASH MITTS

PLUSH MICROFIBER WASH MITT

The Ultra Plush Microfiber Wash Mitts are the softest and most durable mitts yet! The improved design lubricates the surface better than ever, and still will not scratch or damage the painted surface. Usable on all vehicles, including cars, boats, RVs, planes, and more! Remove grime, and see it shine!



1140001B

Ultra-Plush Microfiber Car Wash Mitt with Thumb



1140002B

Ultra-Plush Microfiber Car Wash Mitt



MICROFIBER WASH MITT

The Black and White Microfiber Wash Mitt is designed for multiple uses, including assisting in the washing of bodywork, wheels, wheel wells, tires and grills. The thick-spun strands feature dense fibers that absorb water and soap, making this an ideal mitt for general washing and detailing. The durable construction prevents lint and debris from being discarded during the wash, and will leave a shocking shine upon completion use!

1130004W



MICROFIBER WASH GLOVES

Maxshine Plush Microfiber Gloves assist in reaching hard to access areas around your vehicle and are great for pre-delivery finishing touches. Easy to see dirt, and easy to replace or clean before starting the next vehicle.

2pcs/ pack

1130005R



MICROFIBER CHENILLE WASH MITT

Micro Chenille Wash Mitt is 24x17cm with longer microfiber strands to cover more area. You'll be able to work faster, and the long, plump microfibers will hold even more soapy water for superior lubrication. The microfiber fingers agitate the vehicle's surface to release dirt particles and gather them between the deep strands. Loosened dirt will gather in the mitt, rather than being rubbed against the paint.

Note: For the best results, rinse your mitt in a bucket of water before reloading it with soapy water.

Micro Chenille Wash Mitt is designed for multiple uses. Use it for washing the bodywork, wheels, wheel wells, tires, and grill. The superior durability of this mitt allows it to hold up to rigorous use.



1120003G

Chenille Microfiber Wash Mitt
Double-sided Chenille

1120003Y

Chenille Microfiber Wash Mitt
Single-sided Chenille

CHENILLE WASH PAD

Double Sided Chenille Wash Pad allows you to utilize 2 great tools in one! Use the Microfiber Chenille Sponge side to apply large amounts of soap, while using the strands side to lift dirt and experience a truly superior wash!

1130003R



RUBBER SCRUBBING GLOVES

Our Multi-Function silicone gloves are designed to remove dirt and grime buildup and assist in scrubbing difficult areas. Combined comfort and durability make these gloves a must have for scrubbing all areas of the vehicle, including the wheel wells, tires, and anywhere that has contamination built up.

2pcs/ pack

1130001B



PLUSH MICROFIBER WASH PAD

Maxshine Ultra-Plush Microfiber Car Wash Sponge traps and removes dirt, dust, and debris and will safely clean the surface. Using this high-quality wash sponge ensures you won't have more scratches and swirls when you are done washing. Ergonomic size is easy to grasp with the palm of your hand offers extreme comfort. The microfiber materials used for this sponge is safe on all surfaces and effective with dry and wet applications.



1140003B

Ultra-Plush Microfiber Car Wash Sponge



2pcs/ pack

1140004B

Wheel Microfiber Wash Pad With Sling

MICROFIBER WASH PAD

Made from the same material as its Wash Mitt counterpart, the Microfiber Wash Pad is perfect for any car wash, and can even be used to apply waxes and dressings if necessary. Prevent scratches and swirls with the soft and dense fibers, keeping your vehicle shining!

1120004W



FOAM APPLICATORS

Easily apply wax and polish to your vehicle without Wax and Sealant Applicator damaging the surface! These ultra-soft applicators are entirely nonabrasive and will deliver an even coat of wax or sealant across the entire surface of your vehicle. Featured on the left are microfiber covered foam applicators, and the right features EVA Foam applicators; both of which are perfect for applying your protection!

MICROFIBER WAXING/ SEALANT APPLICATOR

These gentle, yet strong fabric applicators are wrapped snugly around a durable sponge core. The innovative combination of materials allows wax, polish, interior/exterior dressings, and sealants to spread evenly across the entire surface of a vehicle, resulting in maximum coverage.

4pcs/ pack

9011005 Size: 13x8.5x4cm



FOAM WAXING APPLICATOR

4pcs/ pack

9011002 Ø7.4cm (2.5cm + 1.5cm)



Black EVA

TIRE DRESSING APPLICATOR

These new and innovative foam applicators are contoured to spread tire dressing smoothly and evenly while eliminating dripping. Their dual-density foam design allows for durable handle, keeping your hands clean. The contoured applicator perfectly spreads the dressing on your tire's sidewall.

Rinse and Air Dry.

4pcs/ pack

9011003 Size: 10x4cm



Red EVA

SOFT FOAM UFO WAXING/ SEALANT APPLICATOR



8pcs/ pack

9011006 Ø11cm

MICROFIBER COATING APPLICATOR

- Ergonomic design, finger style coating applicator
- Perfect for intricate areas, designed for use on all surfaces
- Smooth and even coverage, makes application comfortable
- Great with any coating, sealant, or wax



9011020

Size: 10cm W x 12.5 cm L

Contents: (2pcs) Microfiber Applicators

Color: Grey

CERAMIC COATING APPLICATOR



12pcs/ pack

9011009 Size: 90x40x(16+5)mm

HYDRO-TECH TIRE GEL APPLICATOR

The Hydro-Tech Tire Gel Applicator is the optimal applicator when it comes to applying waxes and tire shine! Distribute compounds evenly and reach between small cervices on the walls of the tire while applying compounds.

9011014

Size: 8.3x9.5x(2.5+3.5)cm



UFO APPLICATOR

Ultra-soft fabric that allows for cleaning minor areas around vehicle, these applicators are designed for cleaning in mind!

2pcs/ pack

9011010 Ø13cm



INTERIOR SCRUBBING SPONGE

- All-in-one Scrubbing Sponge removes dirt, dust, fingerprints, and stains from interior surfaces
- Bristle-like fibers reach deep to remove the toughest of stains
- Soft microfibers will apply an even coat of protectant
- Perfect for leather, vinyl, soft plastics, and upholstery

Keep all interior vehicle surfaces clean with Maxshine's Interior Scrubbing Sponge. The firm but gentle fibers scrub deep into fabric pores and contours so you won't miss any spots, while keeping your delicate interiors scratch-free.



112000GW

Size: 13.5x8x1.8cm



FOAM WAXING APPLICATOR

The Foam Waxing Applicator is extremely durable, and contoured to fit your hand perfectly while applying waxes, dressings, and more to your vehicle. The soft, high density foam is designed for ultimate softness, absorbency, and longevity, and is specially crafted with the user in mind. Comfort and Efficiency is guaranteed!

9011021 Ø9.04cmx12.16cm

Color:Red+Black



RED HEX GRIP APPLICATOR

The ALL-NEW Red Hex Grip Foam Applicator is extremely durable, and contoured to fit your hand perfectly while applying waxes, dressings, and more to your vehicle. The soft, high density foam is designed for ultimate softness, absorbency, and longevity, and is specially crafted with the user in mind. Comfort and Efficiency is guaranteed!

9011017 Ø10.5x6cm



MICROFIBER COATING APPLICATOR

- Soft and Absorbent: Made with a high-density foam for ultimate softness, absorbency, and longevity.
- Scratch Free: These premium wax applicator pads are precisely stitched to ensure that the edges never touch the surface of your paint which eliminates surface scratches and improves the application of product.

- Absorbent premium microfiber delivers a soft feel and long-lasting quality
- Ideal for interior and exterior car cleaning
- Easily apply polishes, waxes, sealants, and protectants
- Machine washable, durable, eco-friendly, and reusable

4pcs/ pack

9011018

Size: 8.5x1cm



HOOK & LOOP SANDPAPER



Introducing the ALL-NEW Maxshine Hook & Loop Sandpaper, featuring 1200, 1500, 2000, 3000 grit 6in sanding discs. The Hook and Loop Backing makes grit change easy and efficient, and extends the life of the disc. The open coat produces an even and consistent scratching pattern, assisting in the creating an even polish in the final stages of paint correction. Higher grit sand paper is ideal for polishing and finishing non-metal surfaces, as well as wood, paint, rubber, plastic, and other soft materials.

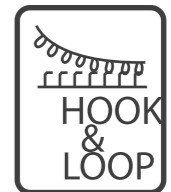

7571200 6 Inch Sanding Discs 1200 Grit



7571500 6 Inch Sanding Discs 1500 Grit



7572000 6 Inch Sanding Discs 2000 Grit



7573000 6 Inch Sanding Discs 3000 Grit

CLAY BAR PRODUCTS

DETAILING CLAY BAR

Clay Bars are an essential tool of the trade, that efficiently remove contaminants from a painted vehicle surface. Contaminants could be Tree Sap, Bug Residue, Tar, Dust, and stubborn Dirt. After cleaning the surface of your vehicle, apply a clay bar (with Maxshine Clay Lube) to efficiently remove any contaminants that create a rough surface and scratches. The final result leaves your vehicle feeling as smooth as glass and brings out the true shine of your paint!

- 2041150P** Heavy Grade (Purple) 3x50g
- 2043150W** Fine Grade (White) 3x50g
- 2044100G** Heavy Grade (Green) 2x50g
- 2042100R** Fine Grade (Orange) 2x50g



DETAILING CLAY TOWEL

Efficiency is key when maintaining a quick timeframe on washing vehicles, which is why Maxshine introduced the Detailing Clay Towel. Easily remove surface contaminants with the advanced, imported rubber polymer coating that achieves smooth, scratch-free results. Rinse after use, and this Clay Towel can be used time and time again.

2043030R Size: 30x30cm



SYNTHETIC CLAY APPLICATOR

The clay/polymer composition allows for faster decontamination
Lasts 3 times longer than traditional clay
Ergonomic grip for comfortable use

204004CA
Size:10.5x6cm (4.13" x 2.36")



BREATHABLE WORK GLOVES

- Breathable polyester construction keeps hands cool and dry.
- Stretchy seamless knitwork provides flexibility and dexterity with a long cuff to keep out unwanted dirt & debris out.
- Durable rubber palm offers extra protection and a non-slip grip.
- Soft micro foamed latex coating reduces hand fatigue.
- Perfect for detailing, automotive work, construction, in the house and in the garden.
- Machine washable.

- 1130001S** SMALL
- 1130001M** MEDIUM
- 1130001L** LARGE
- 1130001XL** X-LARGE

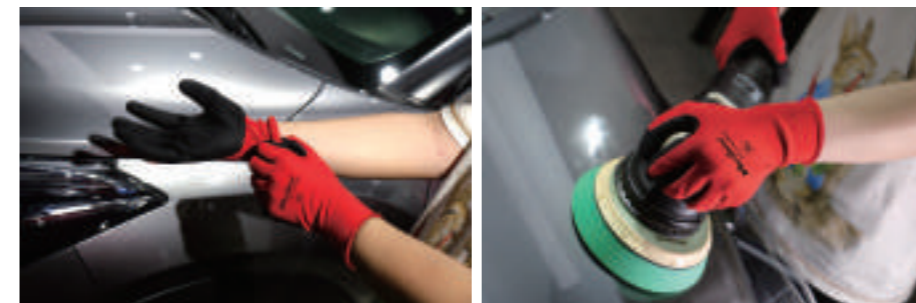

5pairs/ pack

MICROFIBER CLAY MITT - FINE GRADE CLAY

Maxshine's Microfiber Clay Mitt uses advanced Polymer Technology to remove contamination from various surfaces without the use of chemicals.

- Faster, Reliable Clay Usage
- Re-Usable on up to 20-50 cars.
- Removes harmful particles from paint without scratching or damaging the surface.

Step 1: Clean off paint surface with water to begin.

Step 2: Apply Microfiber Clay Mitt to car with Wash Shampoo to remove particles.

Step 3: Wipe surface dry and repeat as necessary.

Step 4: Cleaning Microfiber Clay Mitt – Place in water and allow product to soak overnight for dirt to come off naturally.

204003MT Size:21x16cm Weight: 450gsm



CHENILLE DETAILING CLAY MITT

The Maxshine Detailing Clay Mitt is the ultimate combination of a standard chenille wash mitt, and the innovative magic clay mitt. Designed for multiple uses, and softer than average clay mitts due to the high quality, absorbent microfiber used on the backside of the mitt. Offering an 80/20 blend of re-washable microfiber that delivers a professional finish through numerous washes.

204001MT Size: 22x14x1.3cm



CLAY SPONGE

Clay Sponge is the first step in removing above-surface contaminants from your vehicle's paint, and achieving a smooth, glossy surface. Spend less time with a clay bar and utilize the long-lasting sponge as your essential tool in painted surface protection.

204003CS
Size:11.2×6.2x3cm



DA CLAY PAD

The Dual Action Clay Pad is designed to speed up your clay barring process significantly, with advanced rubber polymer technology in place of originally clay bar formulas. This innovative new pad allows for application with the use of a Dual Action Polisher, picking up contaminants far quicker than its predecessors.

2042125 Ø12.5cm
2042150 Ø15cm



HAND CLAY PAD AND GRINDING POLISHING BLOCK SET

Introducing Maxshine's Clay Pad Grinding Block, an innovative upgrade to traditional clay, allowing the user to manually wax and lightly remove blemishes on the paint. Textured backing allows for an easy application of the pad and features an ergonomic grip for easy use.

Red Polishing Foam Pad specially designed for removing surface defects, swirls, grime, stains, dirt, dust, chemical oxidation, etc.

- Gentle, Non-Scratch Material
- Lasts up to 10x longer than traditional clay!
- Durable Construction
- Clay Pad/Grinding Block/ Polishing Foam Pad Included

2042075S

Package Includes:

- 1pc Polishing Sanding Block
- 1pc Clay Pad
- 1pc Red Polishing Foam Pad



TIRE SCRUB BRUSH



The Tire Scrub Brush is ergonomically designed to ensure a deep clean on tires, ridding them of excess dirt and grime buildup. Its light-weight design and stiff nylon bristles maximize scrubbing power with minimal user fatigue.

7011003 Size: 21x6.4cm Hair Length: 2.5cm

MAXSHINE WHEEL BRUSH

The Maxshine Wheel Brush is the most advanced wheel detailing brush today! Built for quick, effective cleaning on all wheels, the Maxshine Wheel Brush has a state-of-the-art design that cleans any wheel surface and any wheel design without scratching!

7011012 Length: 40cm Handle Length:12cm Hair Length: 15cm

7011013 Length: 45cm Handle Length:18cm Hair Length: 25cm



DUAL ACTION CARPET BRUSH

The 3.5in Dual Action Carpet Brush is great for cleaning and removing deep stains from carpet, upholstery and other surfaces. The durable bristles are 100% polypropylene and resist corrosive chemicals. Use on tires, floor mats, rubber, and other surfaces for a superior deep clean. Attaches to an existing DA polisher with the 5/16 steel shaft.

7012009 3.5" / 85mm

Hair Length: 1 Inch/25 mm

Panel Thickness: 0.43 Inches/11 mm

85mm



DRILL CARPET DETAILING BRUSH

The Heavy-Duty Drill Carpet Brush utilizes the power of your drill to deep clean carpet and upholstery! Use to cut the time it takes to clean carpets. The Heavy-Duty Drill Carpet Brush features deep 3mm nylon bristles that are stiff enough to remove stains, and gentle enough not to damage delicate surfaces.



7011009 5" Thread M8 7011010 4" Thread M8 7011011 2" Thread M8

DRILL CARPET BRUSH COMBO

7011100 2" Thread M8
4" Thread M8
5" Thread M8

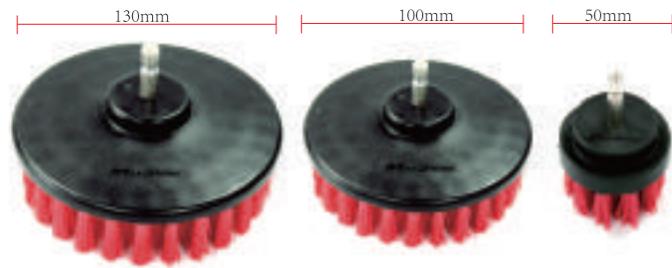

SOFT LEATHER&FABRIC DRILL BRUSH SET

- Made of 100% polypropylene - the most durable material for brushes
- Stiff enough to remove old stains, but soft enough to prohibit damage
- Perfect for light duty scrubbing of cloth or vinyl convertible roofs

7012010

1pc-50mm/2", Thread M8
1pc-100mm/4", Thread M8
Bristle Dia: 0.2mm
Material: Soft Transparent Bristle

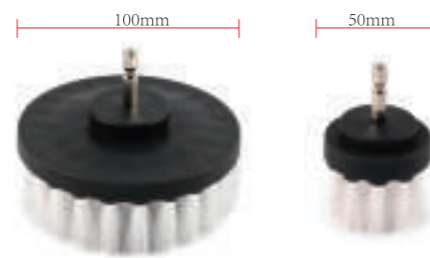

DRILL BRUSH EXTENSION

Drill brush extension is very effective at cleaning hard to reach areas. By adding length and torque to your drill brush you can easily remove deep stains, dust and dirt from the interior of your vehicle and home.

7011021



ERGONOMIC INTERIOR DETAILING BRUSH

Clean and condition delicate interiors and fabrics with this Detailing Brush. The design of the handle allows you to hold the brush in a position that is most natural when scrubbing, creating faster work of your detailing.

7012003

Size: 12.5cm x 5.5cm
Bristle length: 1.5cm
Bristle Material: Horse Hair with Mixed PP
Handle Material: Wooden Handle



ERGONOMIC TIRE BRUSH

This brush is comprised of a durable and scratch resistant wooden handle with strong PP bristles. Gently scrub and lift dirt and grime from wheels for a scratch-free shine. Easily clean away brake dust, dirt, oil, road grime, and more.

7012004

Size: 12.5cm x 5.5cm
Bristle length: 1.5cm
Bristle Material: PP
Handle Material: Wooden Handle



INTERIOR HORSEHAIR DETAILING BRUSHES

Constructed from beautifully stained wood, the Maxshine Interior Horsehair Brush exudes quality without compromising their excellent cleaning abilities. Gentle horsehair is non-marring but provides plenty of structure to ensure proper agitation. Horsehair is uniquely suited for leather, fabrics, vinyl and plastics, or anywhere with a delicate surface.

7022007 Size: 12x4cm
Hair Length: 2cm Wood Thickness: 1cm
7033007 Size: 17x5.5cm
Hair Length: 2.5cm Wood Thickness: 1.3cm
Material: Wooden Handle+Horsehair



LEATHER AND ALCANTARA CLEANING BRUSH



The Leather and Alcantara Cleaning Brush scrubs dust, dirt, and debris from carpets, floor mats, and upholstery. This gentle scrubbing brush is made with an injection molded wooden handle and soft nylon bristle that stand up to years of detailing use. The ergonomic handle transfers powerful scrubbing action into the sensitive fabrics and light stains and contamination in your carpet. Easily scrub and remove light dirt and grime, and pet, mud, grass, or food stains from interior carpets, seats, and floor mats.

7011007 Size: 12x4x1cm Hair length: 2cm
Material: Wooden Handle + Soft Nylon Bristle

LEATHER AND TEXTILE CLEANING BRUSH



The durable and ultra-soft boar bristles are designed for heavy cleaning without the risk of scratching your interior. Its ergonomic design and compact size provide the ability to clean hard to reach areas. Safe on leather, alcantara, vinyl, rubber and fabric.

7012002 Size: 10x3cm
Material: Wooden Handle + Boar Bristle



DETAILING BRUSH SET

The Maxshine Detailing Brush Set features our most versatile brushes, used for a wide variety of cleaning such as dusting air vents, agitating cleaner used on interiors, and more aggressive cleaning on engine bays and wheels. The strong, yet gentle hairs allow for these brushes to dislodge dirt and grime from practically any surface, and are one of the most popular around!



704610 4# (25mm), 6# (30mm), 10# (40mm)

PREMIUM EXTERIOR DETAILING BRUSH



The Premium Exterior Detailing Brush is a more aggressive, strong bristled brush that is still gentle enough to not leave scratches. Designed to clean the dirtiest of areas, to lift dirt and grime that has built up of a long period of time and needs aggressive agitation. Works great on engine bays, fuel doors, and other hard to reach, forgotten areas.



704609
Handle Length: 9"/28.5 cm Bristle Length: 2"/5.5 cm

PREMIUM FLAT MICROFIBER WHEEL BRUSH WITH REPLACEABLE COVER

- Removable Brush Head for easy cleaning and replacement.
- Metal-Free Construction ensures safe, scratch-free wheel cleaning.
- Heavy-Duty Microfiber Sponge Compresses for greater flexibility.

Package Includes:

- 1pc black & white mixed microfiber wheel brush
- 1pc purple & white mixed replaceable brush cover

704622
Total Length:50cm Microfiber Cover Diameter:5.5cm Microfiber Cover Length:18.5cm



ULTIMATE WOOL WHEEL BRUSH -3PACK

The Maxshine Ultimate Wool Wheel BrushKit features three different size brushes all manufactured with chemical resistant, ultra-soft wool heads and non-scratch flexible handles to increase safety and access when cleaning deep-dished intricate wheel designs. Simply spray the wheel with the wheel cleaner of your choice, then dip the brush into water and agitate the wheel. The synthetic wool gently removes brake dust and grime from all types of wheels. Rinse each wheel and dry it with a soft towel to avoid spotting.

704601
Length: 35cm, 40cm, 45cm



ULTIMATE WOOL WHEEL BRUSH -ANGLE REACH HEAD

Manufactured with chemical resistant microfiber that allows for simple and effective removal of dirt and grime from in and around your tires, without scratching the surface of high end rims.

704602
Length: 55cm



45 DEGREE ANGLE MICROFIBER WHEEL BRUSH

Utilizes high-density microfiber for great cleaning ability and durability and features a 45 degree bend for easier access to hard-to-reach areas around the wheel.

704604



MICROFIBER WHEEL BRUSH KIT



Features three brush sizes, suited for cleaning all types of wheels. Excellently designed to clean wheels and vehicle grills, spokes, door jams, engine areas, and other tight locations.

704603
Length: 35cm, 45cm , 50cm



TIRE AND CARPET SCRUB BRUSH

The Tire & Carpet Scrub Brush combines the ideal strength and shape to give you a powerful cleaning tool for your wheels and carpet. Safe on wheels and tough on dirt and grime build up. This brush is the perfect tool to keep on hand when scrubbing is needed.

7011014 Length: 19cm



WHEEL & TIRE SCRUB BRUSH



The Maxshine Wheel and Tire Scrub Brush is the perfect accessory to apply dressings and get a deep clean on your wheels. The soft bristles provide enough durability to scrub away dirt and grime, while maintaining creating enough surface area to apply dressings efficiently.

7011016 Size: 27x9x10cm
Material: PP handle & PVC bristles

WHEEL & ENGINE BRUSH



Modern wheels and engine bays can introduce many areas that are hard to reach and collect dirt, dust and road debris. The brush head is fully covered by bristles making it easier for precision clean intricate areas.

7011017 Size: 30x7.5cm
Material: PP handle and PP bristles

SILICONE INTERIOR DETAILING BRUSH

Modern wheels and engine bays can introduce many areas that are hard to reach and collect dirt, dust and road debris. The brush head is fully covered by bristles making it easier for precision clean intricate areas.



7011030 Size: 29x8cm
Material: Silicone

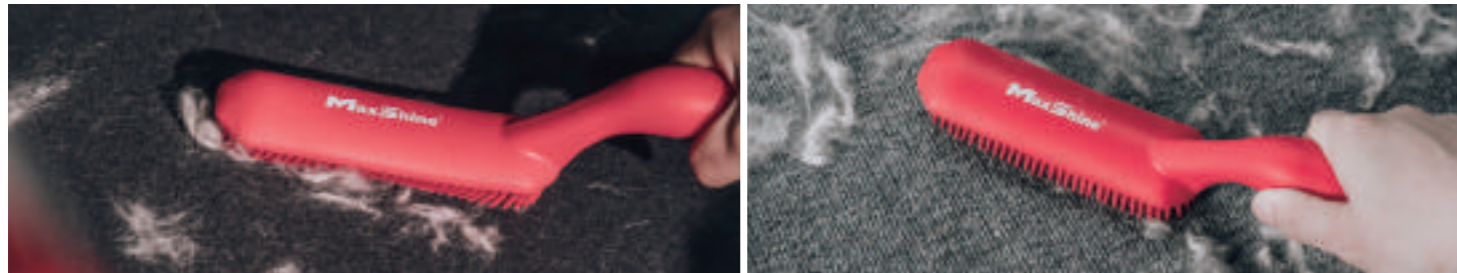

CAR CARPET LINT & HAIR REMOVAL RUBBER BRUSH

The ALL-NEW Maxshine Carpet Lint and Hair Removal Brush is the perfect accessory for anyone with pets! Removing hair and lint has never been easier than now, with the innovative technology built into the rubber bristles that attract fibers with magnetic-like power. Pet hair is a thing of the past!



7011023
Brush Material: PP with TPR
Color: Red and Black

MINI PET HAIR CAR CARPET BRUSH

The mini brush's powerful cleaning blade removes stubbornly trapped pet hair from carpets and fabrics with minimal effort. Use for car details, home cleaning, and removing lint and hair from clothing. Remove even the most persistent hair with this cat and dog hair brush. It's easy-to-use and extremely effective in cleaning even the most difficult of embedded pet hair!



7011028N
Brush Material: ABS+Silicone
Color: Red and Black

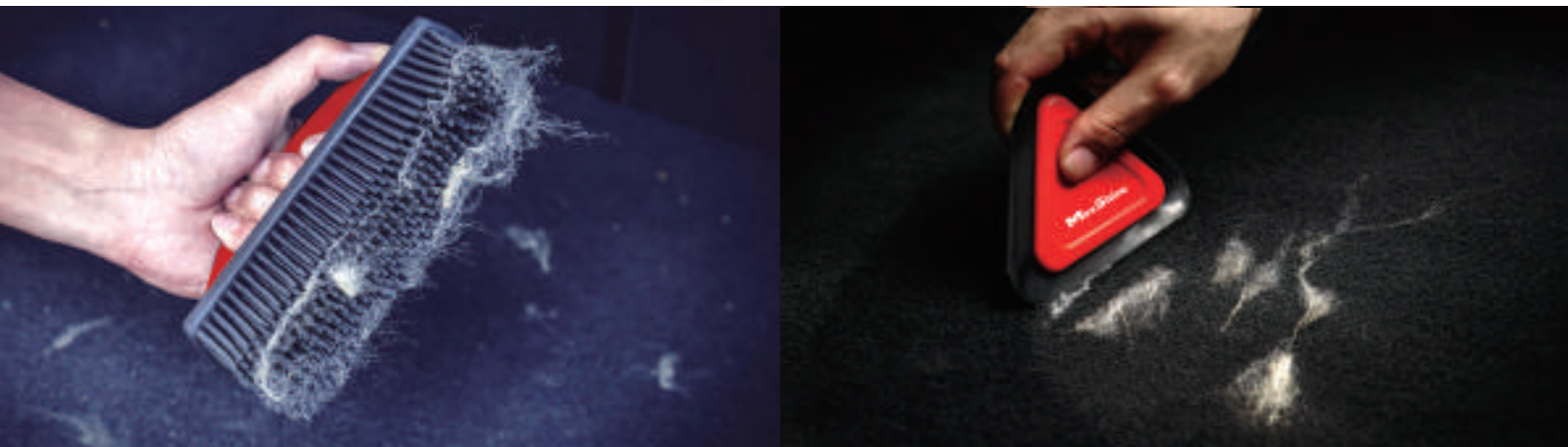

EVER SO SOFT BRUSHES



The Maxshine ESS Brushes are one of the hottest on the market, featuring the softest bristles around and a sleek, ergonomic design that makes holding them feel like a true pleasure. These brushes are the perfect accessory to keep around, allowing you to efficiently clean badges, instrument panels, and delicate areas around the car without ever leaving a scratch or damage. The Maxshine ESS brush is non-slip with high-quality rubber handle.

Small Model:
Bristle Length: 1.77"/4.5 cm
Handle Length: 5.12"/13 cm

Large Model:
Bristle Length: 1.77"/4.5 cm
Handle Length: 9"/23 cm



704606
Maxshine ESS Brush

704607
Maxshine ESS Plus Brush

704608
Maxshine Ess Brush Combo

A true classic in detailing brushes used worldwide, the Boar Hair Detailing Brush is an all-purpose brush that will continue making a huge difference in your detailing experience. Clean all around your vehicle, on interiors and exteriors, and watch built up dirt and grime disappear forever!

- 100% Boar's Hair Bristles
- Ergonomic Designed Non-Slip Handle
- Easy to use and safe on all surfaces

704611 #14
Total Length: 22.5cm
Dia: 27mm

704612 #10
Total Length: 22cm
Dia: 18mm



BOARS HAIR DETAILING BRUSH



ULTRA SOFT DETAILING BRUSHES

Ultra-Soft brushes are specifically designed for light duty cleaning around scratch-prone areas on an automotive surface, such as interior panels in more modern vehicles. They are great tool for any detailer in need of a dusting option, or cleaning around badges and emblems when boar's hair isn't an option!



704616
Detailing Brush
Size: 6 x 4 x 5cm

704615
Detailing Brush Combo

Small
Handle Length: 14cm
Hair Length: 2cm

Medium
Handle Length: 15.5cm
Hair Length: 3.5cm

Large
Handle Length: 16cm
Hair Length: 4.5cm



DETAILING SWABS

Designed for the smallest crevices and spaces in both the interior and exterior of your vehicle. Conveniently removes dust and dirt in those tough to reach areas of your vehicle to keep your car looking fresh and rejuvenated!

704613

Package Includes:

- 2pcs x Large Square Foam
- 2pcs x Large Square Microfiber
- 2pcs x Long-Reach Microfiber
- 2pcs x Dual-Head Microfiber
- 2pcs x Fine-Point Foam



LAMBSWOOL DUSTER

Constructed of a 100% lambswool head and a finished bamboo shaft, the Maxshine Lambswool duster is perfect for removing light dust from a clean, garaged vehicle before a show. Intelligently designed and outmached by its competition, the lambswool duster safely removes dust by relying on a static charge rather than scratch-inducing friction. The duster is designed for repeat use, and can be cleaned with a mild soap.

704605
Length: 62cm
Wool Covered Length: 30cm



FLOW-THRU EXTENDABLE WASH BRUSH

Designed with large vehicles and RV's in mind, the Maxshine Flow-Thru Wash Brush is an extendable scrubbing brush with a hose attachment to keep water flowing near hard to reach areas. This brush features multiple padded grips for added comfort and extends up to 94 inches, making it perfect for tall vehicles. The bustles are tough yet gentle, ensuring that no scratches or imperfections are left behind, like that of its competition.



7011020
FLOW-THRU 10" WASH BRUSH
with 47"- 94" Aluminum Extension Pole

ULTRA SOFT HANDLED DETAILING BRUSH

These Ultra-Soft brushes are specifically designed for light duty cleaning on scratch-prone automotive surfaces. Featuring an ergonomically designed and balanced handle, you will be able to clean longer, safer, and more comfortably.

Whether for an exterior or interior car detail, MaxShine's Detailing Brushes are essential for an efficient car cleaning. Mobile detailers, detail shops, and home users can get a car interior clean faster and those extremely dirt exterior spots shining with ease. Get a hand car wash without tiring or jamming your fingers. MaxShine Detailing Brushes are the perfect companion in any auto detailing.



704621



FOAM PAD CLEANING BRUSH & PAD REMOVAL TOOL

Foam Pad Cleaning Brush and Pad Removal Tool features an innovative wedge on one end and a brush with semi-stiff nylon bristles on the other. This handy tool can fit into a pocket or belt for quick access during a job. The wedge side allows for easy pad removal, greatly reducing the risk for accidental tears and damage to the pad during removal. The bristles are designed to help you clean your pad safely and easily, no matter if it is still attached to the backing plate or removed and ready for cleaning.

7011029

Material: PP+Polycarbafil+Nylon yarn Size: 165x34.5x13mm



FOAM PAD CLEANING BRUSH

The Maxshine Foam Pad Cleaning brush is made of polypropylene and nylon bristles that clean and recondition polishing pads. The Ergonomic handle design fits the curve of the hand. The semi-stiff bristles safely and effectively remove excess polish trapped from the pad surface which makes the pad more effective throughout the polishing process.

- Material: PP Handle, Nylon Bristles
- Ergonomic Handle Design
- Keeps your pads conditioned!
- Use on all polishing pads.

7021001



MEDIUM-DUTY WHEEL & BODY BRUSH

Best for Medium Duty scrubbing and featuring a plush brush head that is optimal for picking up dirt and debris for a brilliant finish! Specialized tips help prevent scratching and swirling on surfaces. Deep cleans Plastic Surfaces and Engine Bays by loosening undercarriage grime and grease. Ideal for Wheels using gentle agitation.

7011025

Red Handle & Double Color
Hair Size: 21 x 8 x 2cm



EXTERIOR SURFACE & WHEEL BRUSH

Light/Medium duty cleaning that gently removes dirt and grime from wheels. Reach deep into wheel wells for thorough cleaning, with soft tips to reduce chances of scratching. The perfect combination of scrubbing power and gentle touch that is a superior clean that anyone can apply to their wash!

7011026

Red Handle & Red PVC
Hair Size: 21 x 8 x 2cm



HEAVY-DUTY WHEEL & CARPET BRUSH

The Heavy Duty scrubbing bristles eliminate dirt and grime on interior surfaces. Separate individual fibers to lift and remove stains. Ideal for carpets, floor mats & durable upholstery, and even your home and office! Ergonomic and durable design allows this brush to be utilized time and time again with proper cleaning.

7011027

Red Handle & Black PP
Hair Size: 21 x 8 x 2cm



DETAILING BRUSH – WHITE CLASSIC

Ergonomically designed non-slip handle for a comfortable grip.
Easy to use and safe on all surfaces. Perfect for narrow or tight spaces.
Great for both interiors and exteriors.
Soft and gentle bristles, densely packed for best cleaning performance.
Constructed with premium PET bristles.

704617Y Series

Black rubber with yellow handle
White PET bristles



Art.N°:704617YS Size:Small #10
Handle Length:17.4cm

Art.N°:704617YM Size:Medium #12
Handle Length:17.6cm

Art.N°:704617YL Size:Large #14
Handle Length:17.8cm



DETAILING BRUSH – CLASSIC BOAR'S HAIR

Anti-slip and ergonomic grip.
Perfect for both interior and exterior detailing.
Brush head is densely packed, allowing for optimum cleaning.
Upgraded boar's hair. Soft, gentle, and durable.

704619O Series

Black rubber with orange handle
Natural Brown Bristle



Art.N°:704619OS Size:Small #10
Handle Length:17.4cm

Art.N°:704619OM Size:Medium #12
Handle Length:17.6cm

Art.N°:704619OL Size:Large #14
Handle Length:17.8cm



DETAILING BRUSH – BLACK CLASSIC

Anti-slip and comfortable grip.
Strong yet soft, densely packed bristles for deep cleaning.
Perfect for both interior and exterior detailing.
Works well dry, or wet with your favorite cleaning solution.

704618R Series

Black rubber with red handle
20% black bristle + 80% black PP



Art.N°:704618RS Size:Small #10
Handle Length:17.4cm

Art.N°:704618RM Size:Medium #12
Handle Length:17.6cm

Art.N°:704618RL Size:Large #14
Handle Length:17.8cm



DETAILING BRUSH – ULTRA SOFT

Non-Slip Rubber Handle with comfortable grip.
Constructed of anti-static materials.
Ultra-Soft Synthetic Bristles
Perfect for delicate surfaces that need a gentle touch.

704620G Series

Red rubber with grey handle
Ultra-Soft Synthetic Bristles



Art.N°:704620GS Size:Small #10
Handle Length:17.4cm

Art.N°:704620GM Size:Medium #12
Handle Length:17.6cm

Art.N°:704620GL Size:Large #14
Handle Length:17.8cm



DETAILING ACCESSORIES

Maxshine Tool Bags are designed with Detailers in mind, featuring spaces for all of your essential tools. Made from high quality fabric, and durable zipper construction, these bags hold up through the rough usage they face on the job. Keep your tools close and organized, simplifying your job while on the go.



600D OXFORD FABRIC DETAILING TOOL BAG

- Space for Polishers, Polishing Pads, Swirl Removers, Compounds, and Brushes.
- Large Open Space, Centered in Bag
- Durable Zipper Construction
- Rubber Molded Zipper Pull-Tabs
- Maxshine Branding
- Shoulder Strap and Carry Handles

6012001 Size: 45x25x30cm
Material: 600D Oxford Fabric



DETAILING TOOL BELT

Spend less time searching for your go-to tools, and wear them instead! The Maxshine Tool Belt features all necessary slots for brushes, lights, compounds, and spray bottles. Paired with our Detailing Apron, this belt assists in keeping you organized and time efficient, with less tools lost or misplaced along the way.



6012002
Includes 5 small pockets, 1 belt.



1680D OXFORD FABRIC CAR DETAILING ORGANIZER BAG

The Small Organizer Bag is designed for essential tools and compounds needed while detailing, including chemicals, brushes, pads, and applicators. This bag features rubber molded zipper pull-tabs and durable zipper track construction, allowing it maintain quality and resist breaking and catching. Branded with the Maxshine logo, this bag shows people you mean business, and that detailing is more than just a hobby. Shoulder Strap is included, as well as carrying handles mounted to the top with a velcro cover.



6012003 1680D Oxford Fabric



DETAILING APRON

The large, comfortable Microfiber Detailing Apron keeps your clothes clean, and protects your vehicle from being scratched or otherwise damaged while working. Made from thick microfiber and waterproof backing to protect for staining your clothes underneath. Features 3 pockets for bottles, brushes, pads, compounds, phone, keys, or anything else you keep on you!

7011001
Normal Size 330GSM
Microfiber with Water Proof Cloth
Black with Red PE Border



DETAILING KNEELING PAD

Place in your work area and feel the comfort of working down low on your vehicle or around the house, all while saving your body from excessive strain.

MKP01 Size: 18" x 11" x 1.6"
Material: EVA Foam



HEADLIGHT RESTORATION SYSTEM

Foggy Headlights? No Problem! The Maxshine Headlight Restoration Kit is one of our most popular products, allowing the user to fully restore old, faded headlights, increasing the value of their car and restoring full visibility while driving at night.

Designed to restore and maintain all types of smooth plastics and headlights quickly and safely. Headlights will remain clear for up to a year and can be protected using a ceramic coating when finished. Easily remove the yellow, faded build up from years of neglect, and see your car immediately look years younger! The included Restoration System Compound restores clarity after sanding and adds a protective layer to maximize longevity.

MHL01

Includes:

Foam Sandpaper P1000 75mm x 2pcs
Foam Sandpaper P2000 75mm x 2pcs
Foam Sandpaper P3000 75mm x 2pcs
Drill Backing Pad 75mm M6 x 1pc
Ultra Towel 40x40cm x 1pc
Polishing Foam Pad - 3" x 1pc
2oz Cutting Compound & Finishing Polish x 1pc

M312 EXCLUDED



Maxshine recommends pairing the M312 and Headlight Restoration kit together for optimum results.



DETAILING SWIRL FINDER PRO

Durable Construction
Magnetic Grip at Base
Charging Station - USB Cable
LED Lit Battery Status
Charging Time : 4 hours
Quick Color Controller-3 Color
Battery: 3.7V 2600mah Li-ion

DSF003



DETAILING INSPECTION LIGHT

The Maxshine Ultra Bright Folding Light is the ultimate swirl finder, making even the most fine and light scratches visible to the user. Turn on the adjustable turning dial to the desired brightness and mount the magnetic base to any metal surface for a stable, hands-free light source. Light up dark crevices in your cabin during interior details, or hard-to-see areas of an engine bay with the brightest shine in the market!

DSF002
300 Lumens
with USB charger



AUTOMOTIVE MASKING TAPE

The different widths of Maxshine's Automotive Masking Tape will meet your various needs. Ideal for customized vehicle paint graphics, paint correction and headlight restoration protection, and any other automotive DIY projects.

Detailers! Need to be quicker in the detail shop or when on the go with a mobile detail? Need to make a hand car wash or a car seat cleaning more comfortable? Detailing accessories aid in achieving a full service car wash and mobile car detail. All aspects of auto detailing can be made faster and easier with the assistance of detailing accessories.

- Constructed of quality textured paper
- Easy to stick and tear
- Won't lift while working
- No adhesive residue
- Multipurpose capability

MT18 - 1 roll

Dimensions: 1.8cm x 50m
Color: Red

MT36 - 1 roll

Dimensions: 3.6cm x 50m
Color: Red

MT18P - 4 rolls/pack

Dimensions: 1.8cm x 50m
Color: Red

MT36P - 4 rolls/pack

Dimensions: 3.6cm x 50m
Color: Red



WHEEL COVER

Stop weather damage to your wheels. Maxshine's PU coated wheel covers are waterproof and made of durable material to protect from all kinds of weather. Keep them free from dirt while storing. They also protect bare metal wheels from harsh chemicals during the detailing process.

- Constructed with durable material
- Waterproof
- Appropriate for all weather
- Easy on/Easy off

WLC01

Material: PU coated Oxford Cloth
Wheel Fit: Up to 22" diameter



AIR BLAST VACUUM GUN

- Power Vacuum and Air Dry
- Boosts Vacuum Suction
- Durable Construction
- Increases Work Efficiency

Accessories:

- Vacuum hose 1.8m
- Vacuum adapter: 32-42mm w/Universal joint



Technical Specifications

Art.N°	Speed	Air Cons	Overall Length	Net Weight	Air Inlet
ACG002	6000RPM	4.2cfm	12.5 inches	1.1lb	1/4"

NOTE : Can be used as a regular vacuum head when air compressor is not attached.



SNOW FOAM CANNON



SMFC001

Material: PP with copper
Cup Volume: 1L

Requires Pressure: 70BAR - 1000PSI
Maximum Pressure: 200BAR - 5300PSI
Maximum Flow: 5.3GPM
Orifice Size: 1.25mm
Touchless technology for safe pre-soak detailing.
Attaches directly to any pressure washer.
Accurately mix foam detergents to produce a thick, rich foam to lift dirt and debris. Adjustable wide angle spray.
Made with high quality brass and chemical resistant materials for maximum durability and performance.



PUMP FOAM SPRAYER



SFS001

Cup Volume: 1.5L

The Maxshine Pump Foam Sprayer does not require a pressure washer, and assists in foaming on the go. Easily clean wheels and exteriors with a few pumps. The portable design allows for easy storage and cleaning when finished.



LOW PRESSURE FOAM GUN



LPG001

Cup Volume: 1L

This Low-Pressure Foam Gun mixes soap, air, and running water to create exceptionally foamy suds! Attach to a garden hose and remove abrasive dirt particles that can leave scratches and swirls. Turn any car wash into a foam-covered authentic detail!



SNOW MASTER FOAM CANNON

SMFC002

Material: PP with copper
Cup Volume: 1L

The ALL-NEW Snow Master Foam Cannon is a full upgrade from the original, featuring a shorter base for easy free-standing storage and a specialty wide-mouthed head that produces a wide range of foaming options.

Features:

New Heavy Duty Design.
Quality Fittings and Durability.
Maximum Pressure 160 Bar.
Max Temp 60 Degrees.
Orifice Size: 1.25mm



CAR AIR CLEANING GUN

ACG001

Lower air consumption and noise emissions. its ability to use less air and operate with less noise. It requires less maintenance and is less vulnerable to wear and tear.

Use with Interior Super Soap to remove grime and dirt. The Interior Super Soap is a low-foaming cleaning agent specially designed for use with Cleaning Tools. It breaks down dirt and grime, removes odors, and contains darkening agents that revitalize vinyl.



HIGH PRESSURE SPRAY CAR WASH GUN



A



Quick Release Coupler
1/4" Female
Attach to A - Then attach your quick release foam cannon



Quick Release Connector
3/8" Male
Attach to B to attach Snubby to Pressure washer with quick release



Twist & Plug Connector
M22 14mm
Attach to B to attach Snubby to Pressure washer without quick release

HPG001

Light and Easy to Use.
345 Bar – 5000PSI
Quality Brass Fittings
Anti-Skid and Wear Resistant Handle
Multiple Nozzles



B



SNOW FOAM CANNON ADAPTOR



FC-01
Nilfisk Pro



FC-02
Bosch New



FC-03
1/4 Quick Coupling



FC-04
Karcher

EZY WHEEL

Ezy Wheel are a revolutionary tool that prevents your hose and cords from getting caught underneath your tires during a detail. Made from heavy duty polyethylene, these strong tools may very well be the most handy detailing tool you've ever used! The unique design features a roller system that helps your hose or cord move along the guard and prevents any unnecessary friction, as well as a lip on top and below the rollers that keep the hose contained.



703102
Material: Plastic
2pcs/ pack



Maxshine Ezy Wheel uses a system of rollers to keep your hose moving during a wash instead of getting stuck!

PRESSURE WASHER NOZZLES

The Pressure Washer Spray Nozzle Tips including 0°, 15°, 25°, 40°, 65°, you can choose different angles spray nozzle according to the actual needs.



701202 5 different spray angles

WIPER BLADE SQUEEGEES

These Automotive Squeegees are constructed from a unique rubber and silicone material which conforms to the body of the car and pulls off the water in one swift motion.



7011022 Red
7011024 Transparent
Size: 33 x 7cm

MEASURING CUPS

Features a curved spout for precise pouring and easy-grip handles for comfort. These cups have easy-to-read measurements that allow for accurate liquid transference.

710101 100ml
710102 1000ml



RO POLISHING EXTENSION SHAFT SET

The Rotary Extension Shafts were designed with detailers in mind to overcome the difficulty of reaching tight and awkward areas, such as round wing mirrors, spoilers sills & bumpers while polishing with a rotary machine. Extension Shafts offer extra clearance to safely polish these areas without the risk of striking the paint. These high quality stainless steel shafts come in a 2", 3", 5" length and are notched to make removal easy, and will fit all M14 backing plates.

7015812

Made from Stainless Steel

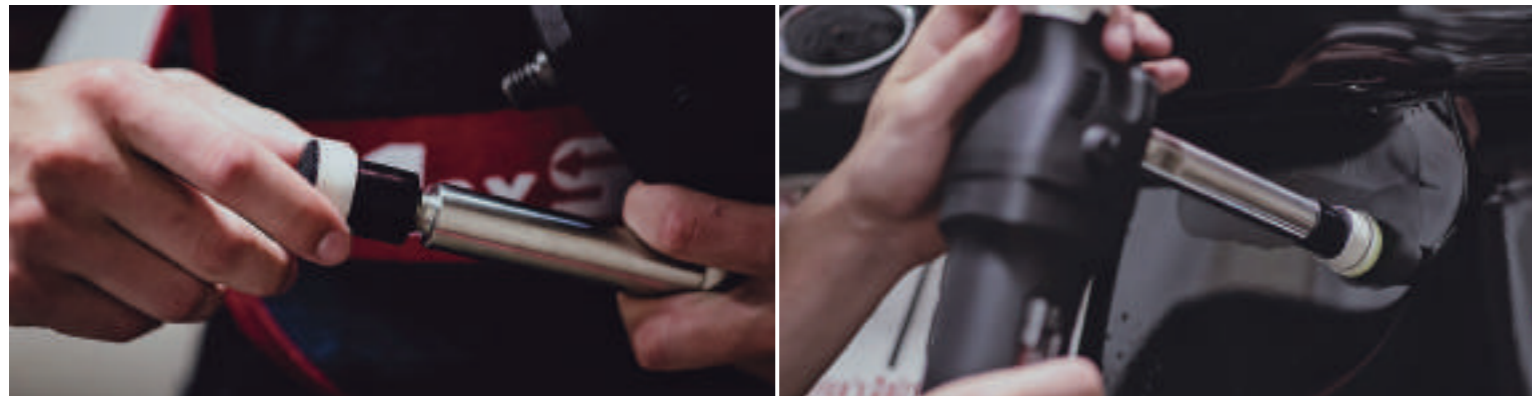

FOAM FINISHING CONE

The fine and soft sponge tissue can double protect the paint surface.

It can creat high gloss paint surface while without spiraling traces.

Particular sponge structure enhances the air flow.

Better heat dissipation.

7011004 Ø80mm, M8 Red

Material: Germany Foam



HEAVY DUTY CHEMICAL RESISTANT TRIGGER SPRAYER

Hand-held sprayer used for car care, home and industrial cleaning

No pressure washer or foam cannon needed

Portable design is sleek and can be stored in a tool bag

Easy to clean and maintain

Provides foaming solution for cleaning wheels, exterior, upholstery and fabrics.

Also frequently used at home, in the garden and on the fly

USAGE INSTRUCTIONS:

1. Check each component of the sprayer to make sure its securely fastened.
2. Fill empty canister with approximately 25 oz of water then add the soap. (2-3oz)
3. Securely shake to mix the solution.
4. To eject by pressing
5. Small and convenient, easy to carry out, make your car brand new anytime and anywhere



RTS750-R

Color: Red

Capacity: 750ML

Trigger: Made in Taiwan,China.

Bottle: Made in China.



RTS750-Y

Color: Yellow

Capacity: 750ML

Trigger: Made in Taiwan,China.

Bottle: Made in China.



RTS750-G

Color: Grey

Capacity: 750ML

Trigger: Made in Taiwan,China.

Bottle: Made in China.



RTS750-B

Color: Black

Capacity: 750ML

Trigger: Made in Taiwan,China.

Bottle: Made in China.

DETAILING WASH BUCKET

Professionals recommend the two-bucket system to guard against wash-induced swirls. Fill one bucket with soapy water and fill the second bucket with clean water. Each time you need to reload your wash mitt, rinse it in the clean water first. Then reload the mitt in the soapy water. This extra step will keep the wash water clean and reduce the amount of dirt you transfer back to the paint.



MSB001-R



MSB001-GN



MSB001-G

3.5Gallon(13L)
Size: 300x265x280mm



MSB002-R



MSB002-GN



MSB002-G



MSB003

5 Gallon (20L)
Size:305x265x385mm

MULTIFUNCTION BUCKET LID SEAT WITH SOFT FOAM

- Bucket Lid Seat snaps securely on Maxshine's buckets and includes a padded top for comfort.
- Turns any bucket into a comfortable seat, kneeling post, step stool, or storage container.
- Fits on any 12" diameter standard round bucket.
- Comes with convenient side rail for hanging detailing accessories.

NOTE :Chemicals, Bucket, and other items are shown for visual reference are sold separately.

MSBL01-R

Dimension: 35.2x31.2x3.5cm
Material: Hard plastic & Sponge
Color: Red+Black



MSBL01-B

Dimension: 35.2x31.2x3.5cm
Material: Hard plastic & Sponge
Color: Black+Red



ENJOY CAR WASH KIT

Enjoy washing your vehicle with this fully loaded kit. With the various types of washing materials, wheel and tire brushes, and towels, with the wash bucket to boot, you won't be lacking any detailing tool you'll need for a thorough wash.

MSB10

THE KIT INCLUDES

1PC x 3.5 Gallon BUCKET WITH LID
1PC x TIRE CLEANING BRUSH
1PC x WHEEL BARREL BRUSH
1PC x CAR WASH MITT
1PC x SYNTHETIC WOOL WASH PAD
2PCS x GENERAL PURPOSE TOWEL
2PCS x POLISH REMOVAL TOWEL
2PCS x MICROFIBER TOWEL



SAND KILLER

Placed in the bottom of a bucket to filter debris and sediments when washing tools like scrub pads or mitts. Improve the finish of your vehicle by keeping your mitts clean. Fits in 3-5-gallon buckets!

MSK001

Size: Fits 3-5-gallon buckets.

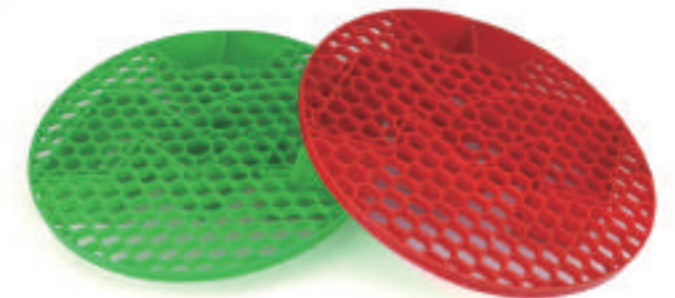

BUCKET DOLLIES

Bucket Dollies are an essential accessory to any car wash and detail job! Simple installment of the bucket and easily removable when finished. The 360 Degree Swiveling set of wheels and the included spaces for Spray Bottles and Brushes, allows you to speed up the washing process while increasing mobility and efficiency!



702306



702307



702311

Material: Heavy Duty Polypropylene
Bucket Capacity: 2.7 - 5 Gallons



METAL BUCKET DOLLY-BLACK

Maxshine's ALL NEW Storage Solution gives you durable mobility with your buckets during a wash. Utilize a single Metal bucket dolly, or using the Metal Bucket Dolly Connector, combine 2 for a rolling two bucket method! Includes spaces for Spray Bottles and Brushes and combines quality steel with specialized spray coating to prevent rust.

H12

Material: Steel
Bucket Capacity: 2.7 - 5 Gallons
2 Bottle Spaces: 16oz
5 Brush Spaces



BUCKET DOLLY CONNECTOR

H12-1

Combine Bucket Dollies 2 for a rolling two bucket method!

Material: Steel
Compatible with H12



MODULAR DETAILING CREEPER

- Lightweight and durable from the polyethylene body and steel frame construction
- 2" (Mini Creeper)& 4"scuff resistant casters.
- Side trays, bottle holders, and storage drawer to keep tools close at hand
- Converts to a Mini Creeper for mobile kneeling or ground level sitting
- **Optional Soft Cushion increases comfort while sitting or kneeling**

702309-P

Dimensions: 95cm x 40cm x 36cm
(with additional bottle holders)
Holds: 6 bottles (4-22oz max)
with additional holders attached

702309-S

Dimensions: 50cm x 30cm x 8cm

702309-H

Dimensions: 47cm x 26cm x 11cm
Material: PPT30



702309-H
Mini Creeper

702309-S
Soft Cushion for Modular
and Mini Creeper

702309-B
Modular Detailing Creeper
Bottle holder, set of 2

PREMIUM HEAVY DUTY DETAILING CART

- **Durable:** Constructed from high quality PP material
- **Effortless Maneuverability:** 4" wear-resistant casters with brakes
- **Organized:** Top shelf comes equipped with four 16oz or 32oz bottle holders, Two phone or mini pad holders, four detailing brush holders, and two polisher holders
- **Security:** Recessed shelves keep tools in place
- Two side plates with 12pcs hook to keep tools close at hand.

702312

Dimensions:90.25x46x86cm
Color: Red+Black
Material:PP
Durable Plastic Trays Removable Shelf Dividers



PREMIUM DETAILING ROLLING TROLLEY



Whether you're washing, claying, polishing, or waxing your ride, the detailing cart makes all steps of the detailing process effortless. The easy to reach polisher holder keeps your polisher conveniently placed wherever you go.

702308
Size: 50x80x40cm
Material: Steel



UNIVERSAL DETAILING CART

The Maxshine Universal Detailing Cart is equipped with durable, swiveling wheels, making it easy to take on the go. Featuring 3 levels of storage options, this cart provides ample room for all of your detailing tools and makes storage and time management an easier task. Easy installation makes this cart a must-have and can be assembled in a matter of minutes!

702302N
Tray size: 66x33cm
Overall dimensions: 66x33x77cm



FOLDING STEP STOOL

Designed for ease of use and simple storage. Maxshine's Folding Step Stool is an essential tool to assist in reaching high up areas on a vehicle or anywhere around the house. Practical and Sturdy, this addition to your daily routine helps with any task!

702305
Size: 72 x 58 x 43cm
Load Bearing: 250 lbs
Two Steps



DETAILING STOOL WITH MODULAR TOOL TRAY

Oversized seat for maximum comfort.
Adjustable seat height to accommodate all detailing tasks.
Ample storage in the easy access tray below the seat.
Removeable bottle holders.
Heavy-duty casters.
Become faster and more efficient in your detailing duties with this Detailing Stool. Keep your tools in close reach with the modular tray while sitting comfortably in the oversized seat.

702310
Height: 19-25 inches
Load Capacity: 330lbs



DETAILING STOOL

The Maxshine Detailing Stool is another great option in the lineup of seating preferences. Designed to bring delightful comfort to the user with an adjustable cushioned seat, making cleaning wheels, tires, or polishing lower rocker panels a breeze! The bottom plate is durable and perfect for storing your tools and compounds while making your way around the vehicle. Equipped with full 360 degree swiveling wheels that adjust to any movement you make, making travel easy while on a smooth surface.

702301
Min.Height: 41.5cm
Max.Height: 55cm



MINI HANDHELD DRYER

- The efficient 1.5HP motor increases air temperature, up to 25 degrees above ambient temperature, which provides faster drying
- It's filtered air is ideal for delicate surfaces like paint, chrome, and plastics
- The ergonomic handle optimizes reaching every area in any orientation
- Perfect for removing water out of all the hard-to-reach places like grilles, bumpers, vents, and wheels
- More efficient and powerful, while remaining light weight

Maxshine Mini Handheld Dryer may be light and compact, but it packs a big punch. Ideal for safely and easily drying every bit of a vehicle, it comes with a handy 20ft/ 6M Cord and a choice of 2 nozzles to suit any job.



Air Filter

Filter the air and thicken the filter element to avoid sucking some dust particles into the motor.

Contactless Drying

Stops marring & swirls

20ft / 6m

Professional Cord



Technical Data

Art.N°	Power	Volume	Cord Length	Rated Frequency	Horsepower
EVO-S	220-240V/10AMP, 1200W	22000FPM, 90CFM	6m(20ft)	EU 50Hz	1.5HP

Included: 2 nozzles available

Maxshine Mini handheld dryer may be light and compact, but it has strong impact.

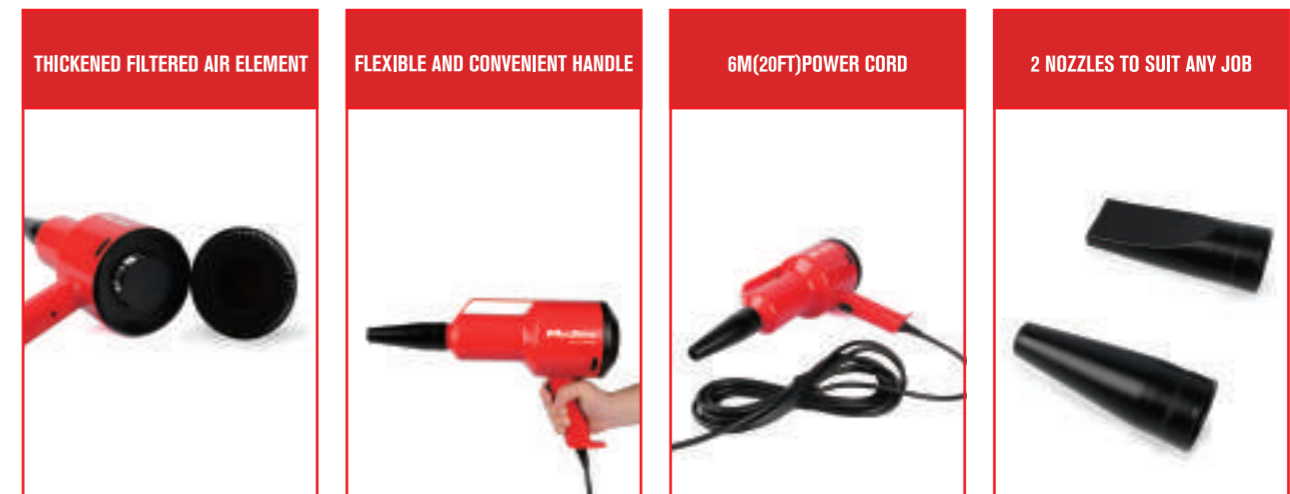

Before



After

DETAILING BUCKET CADDY

- Detailing Bucket Caddy effortlessly hangs on the edge of your wash bucket.
- Holds an assortment of washing detailing accessories with specific holes for brushes.
- Compatible with buckets of any size.
- Two integrated drainage holes ensure your detailing tools are kept dry and away from dirty water.

NOTE : The item does not come with a bucket

MSBH01-R

Dimensions: 34x15x22.2cm
Brush slots: 14mm & 18mm
Material: PP
Color: Red



MSBH01-B

Dimensions: 34x15x22.2cm
Brush slots: 14mm & 18mm
Material: PP
Color: Black

