

Cell Type CR14250SE Specifications

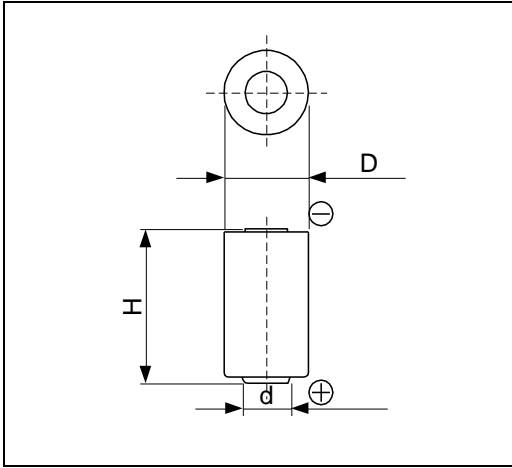

Nominal Voltage (V)		3
Nominal Capacity (mAh) *1		850
Standard Discharge Current (mA)		0.5
Operating Temperature Range (°C) *2		-40 ~ +85
Max. Dimensions (mm)	Diameter (D)	14.5
	Height (H)	25.0
Approx. Weight (g)		9

*1 Nominal capacity is determined at an end voltage of 2.0V when the battery is allowed to discharge at a standard current level at +23°C.

*2 Consult FDK when using batteries at temperatures exceeding the -20°C to +60°C range.

Typical Characteristics

Discharge Characteristics of CR14250SE

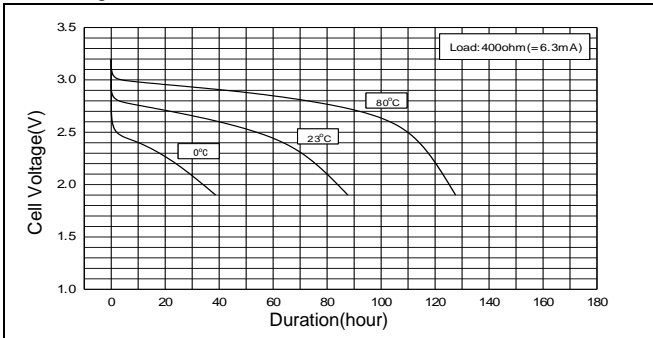

Discharge Characteristics of CR14250SE

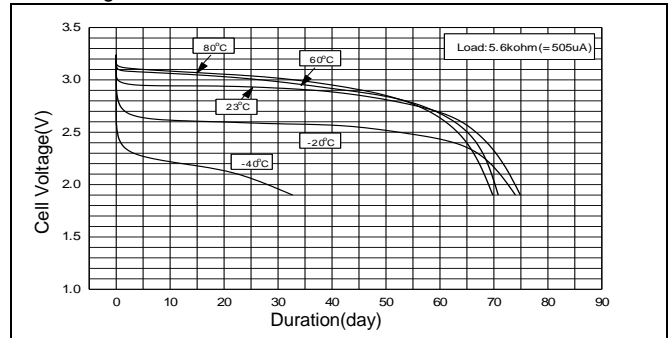

Discharge Characteristics of CR14250SE

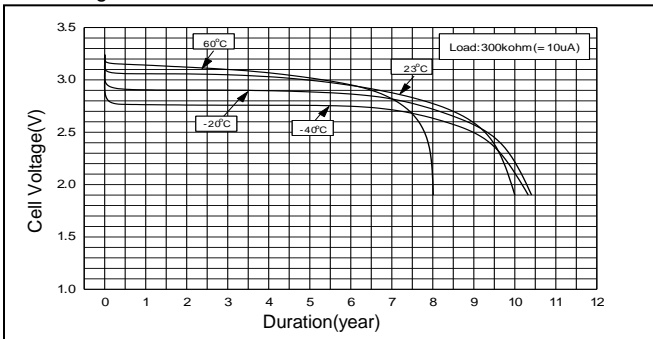

Discharge Load vs. Capacity of CR14250SE

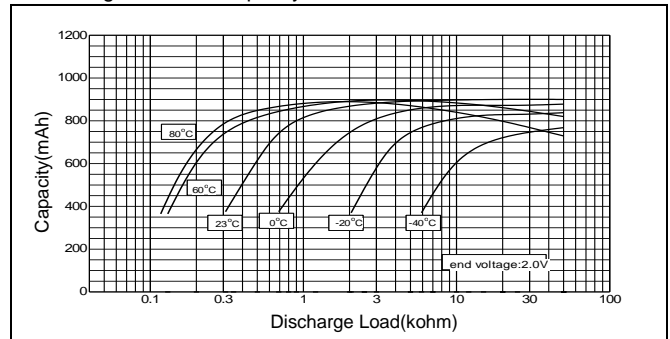

Discharge Load vs. Operating Voltage of CR14250SE

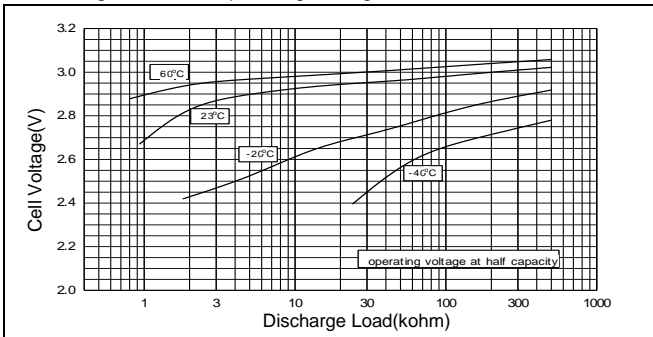

Discharge Characteristics of CR14250SE

