



Maytech MTSKR1905WF Waterproof Remote Control User Manual V2.0

1. Functions:

1.1 It's the first full waterproof remote in the industry and works well in water, especially for electric surfboards;

1.2 It's the first wireless charging remote control in the industry;

1.3 With OLED display, easy to view throttle and battery voltage;

1.4 Standard PWM signal output, can be used in electric surfboards, electric skateboards, rc cars, rc boats, rc airplanes, robotics, etc;

1.5 It supports motor RPM detection by motor phase wire or hall sensor wire;

1.6 It supports VESC communication protocol. Datas in VESC can be obtained and displayed through the UART port;

1.7 It has one 30V 3A Relay mechanical switch and one 20V 2A transistor electronics switch for esk8 lights, esurf water pump using, etc.

2. Configuration:

Remote (Transmitter) :

IP rating: IP67

Triggers: Throttle trigger and Brake trigger(ESK8 mode: Throttle and Brake; Esurf mode: Throttle and Cruise speed control, No Brake)

Sensor Type: Non-contact Hall sensor

CPU: STM8

Display: 128x64 OLED, yellow and blue screen

Battery: 3.7V/420maH

Full-charged working time: more than 5 hours

Charge interface: Qi standard wireless charging interface

Transmission distance: Air 10M; Water 1M

Receiver:

Power supply: 5V, automatic switch

Throttle signal output: 1-2ms PWM 3.3V Max

Voltage detection range: 5-80V $\pm 5\%$

Hall/Motor phase wire RPM detection range: 0-80000 ERPM

Relay switch max current: 3A

Transistor switch max current: 2A

VESC communication protocol Baudrate: 115200bps

3. Remote (transmitter) appearance:

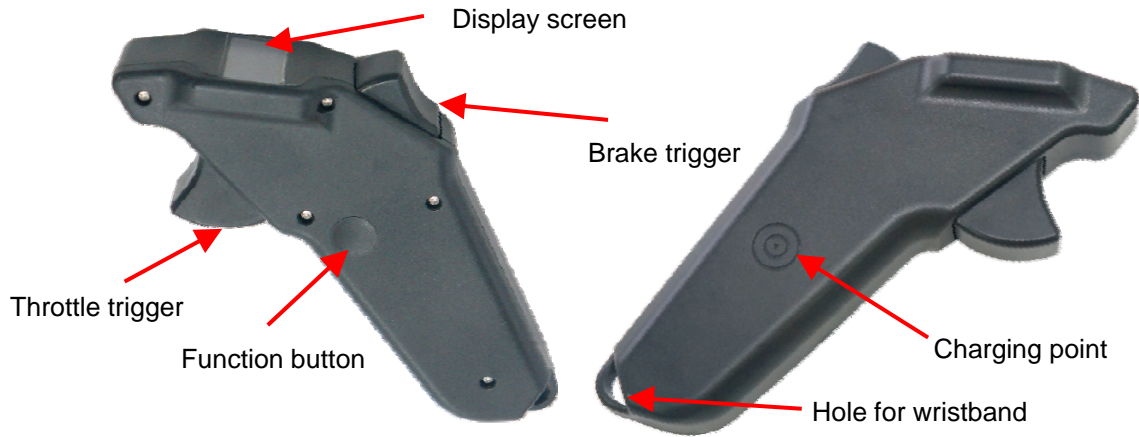

4. Receiver appearance

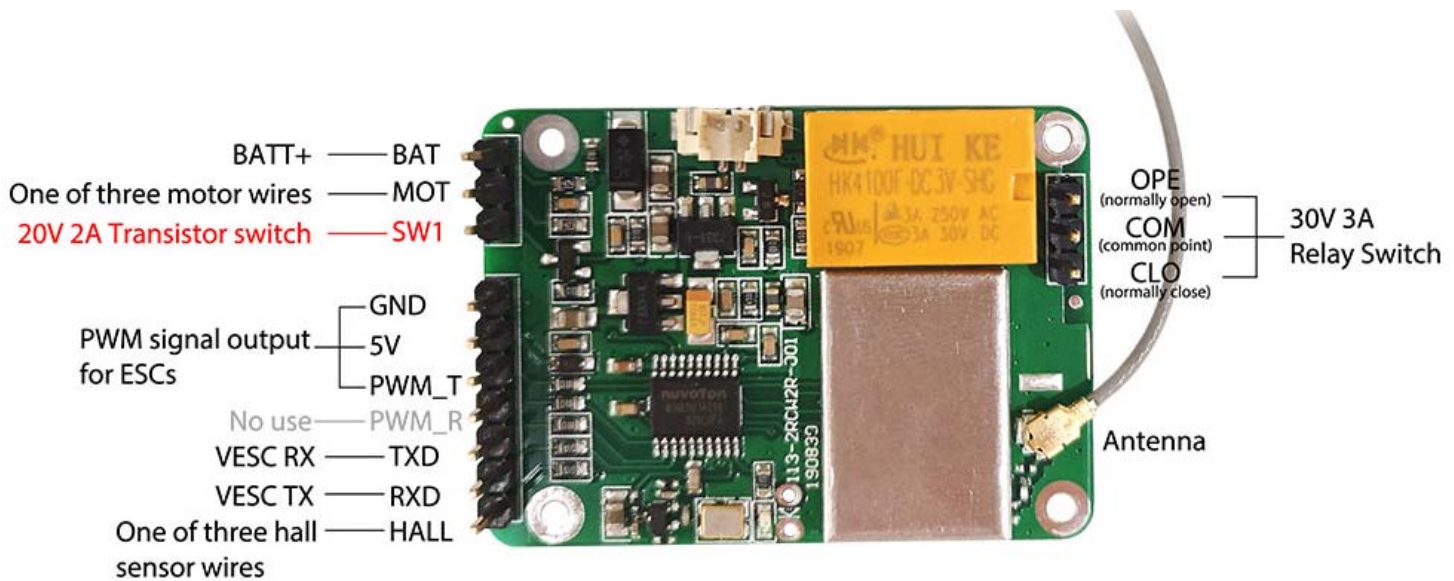

5. Receiver wiring instruction

5.1 Receiver and Maytech MTSF300A-OPTO ESC wiring diagram (other ESCs can refer to this.)

5.1.1 Note: When use hall sensor to detect motor RPM:

~If your don't use motor hall sensor to ESC hall sensor and just use it for detecting motor RPM, please connect one 5.1K pull-up resistor between one hall wire and +5V wire. Otherwise, hall signal will not be detected by receiver.

~ If you use hall sensor with ESC for motor spinning, then you don't need to connect the pull-up resistor for motor RPM detection

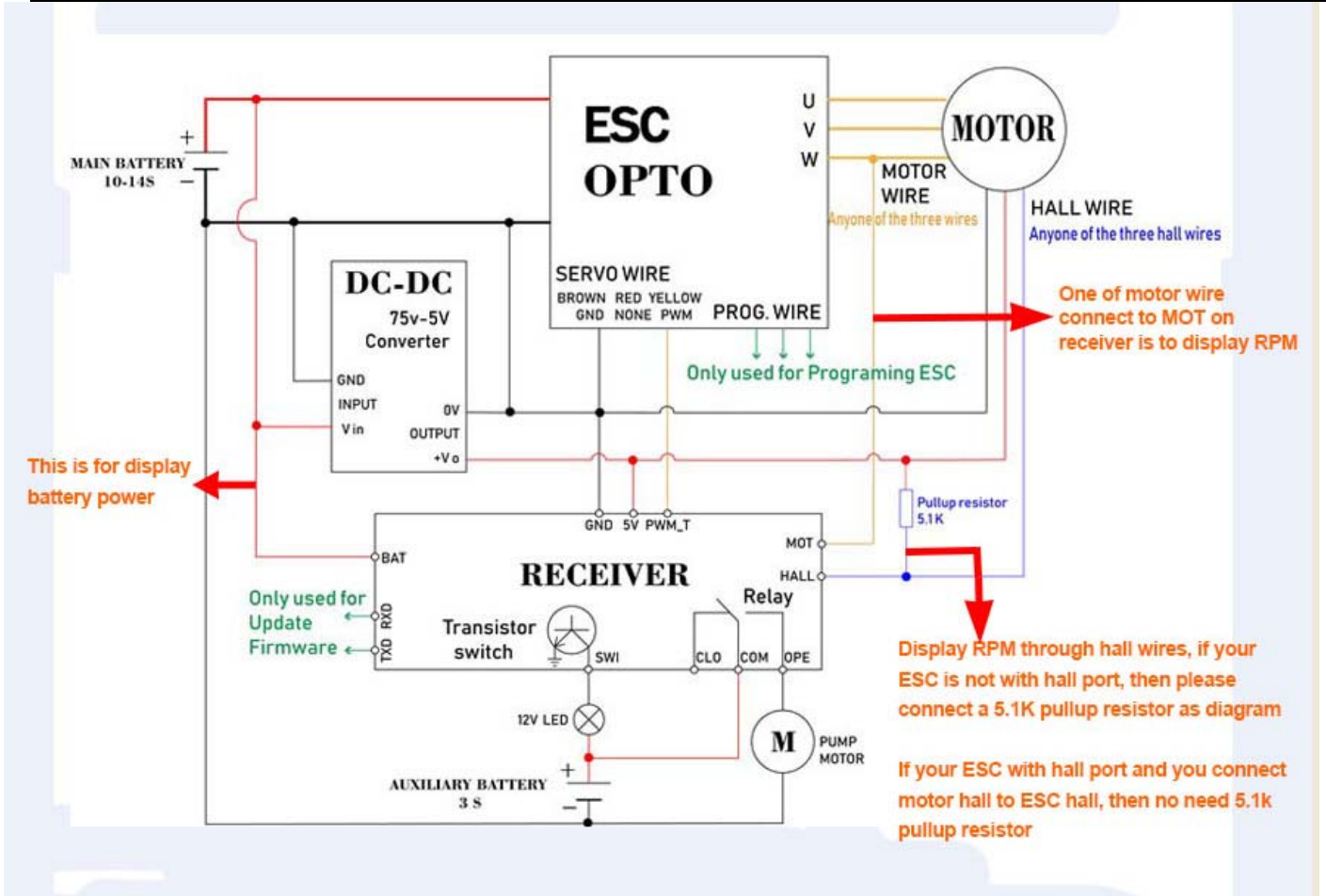

5.2 Receiver and Maytech ESCs based on Benjamin VESC wiring diagram:

- 5.2.1 If connect Motor hall sensor to Maytech VESC based controllers or VESCs, VESC internal pull-up resistor will be used, so this application does not need an external pull-up resistor.
- 5.2.2 Cross connection of Receiver TXD/RXD and VESC RX/TX:
Receiver's TXD>> VESC RX;
Receiver RXD>> VESC TX.
- 5.2.3 VESC supports UARR and PWM(PPM) throttle control. When use with Maytech waterproof remote, you can select UART/PPM/PPM and UART three control options, and select corresponding control in remote ("6. Data Source" and "11. VESC Thr"). We recommend to use PPM and UART control: PPM to control throttle and UART to read voltage/current/ temperature/speed/etc. Please refer to Item "16.2" and "16.5" in this manual.
- 5.2.4 Please set "Baudrate" to "115200 bps" in VESC_TOOL.

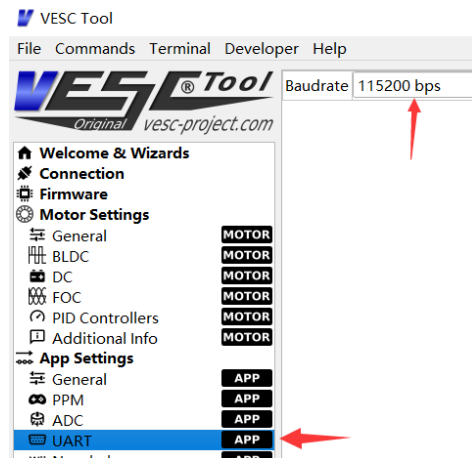
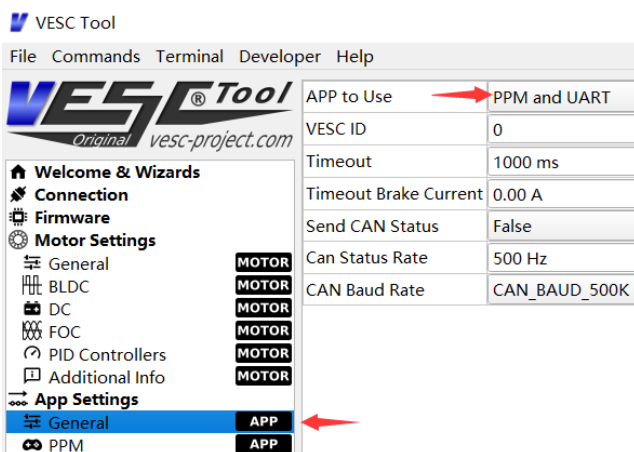



Type A: Internal Receiver type, built-in Maytech MTSRR1905WF receiver, can only work with MTSKR1905WF remote:

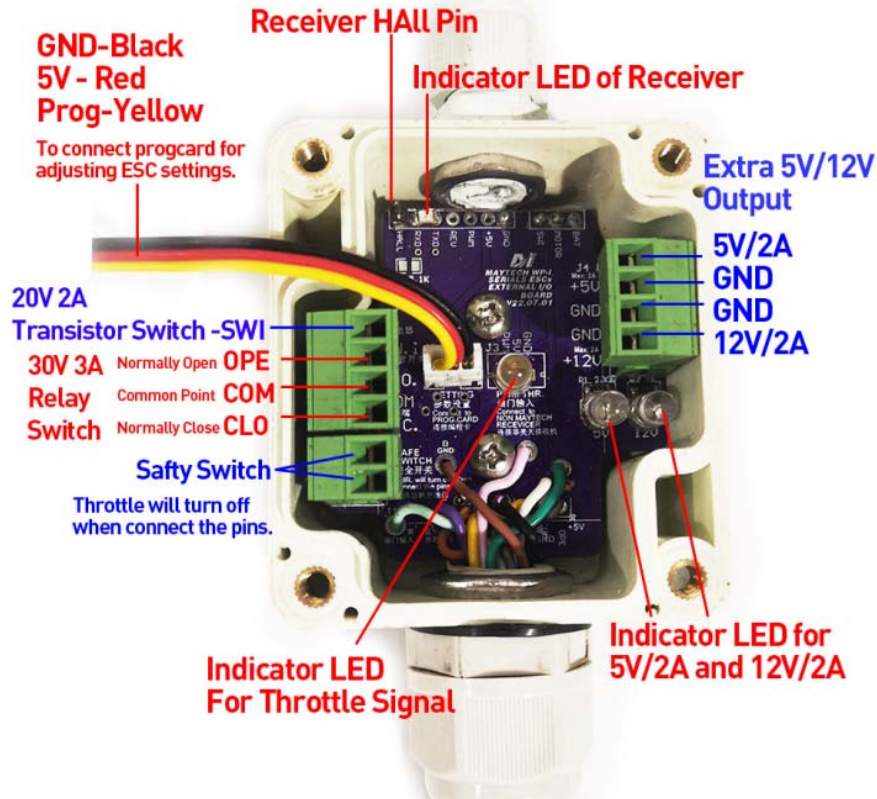

Type B: No receiver type, no receiver built-in, can work with Maytech remote or other remotes

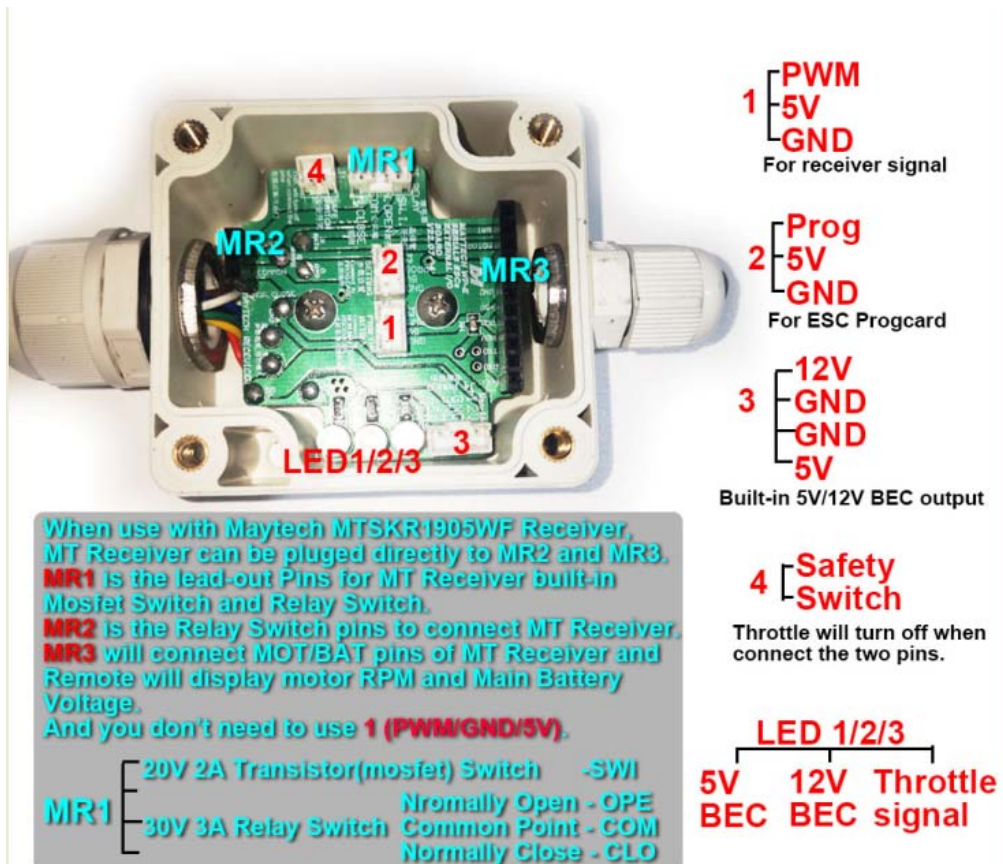

Please note:
If use other supplier's remote and receiver, MR1/2/3 pins don't work.

5.4 Receiver accessories

5.4.1 DuPont Cables: One 7pin 20cm; two 3pin 20cm. (color may be different for different batch.)

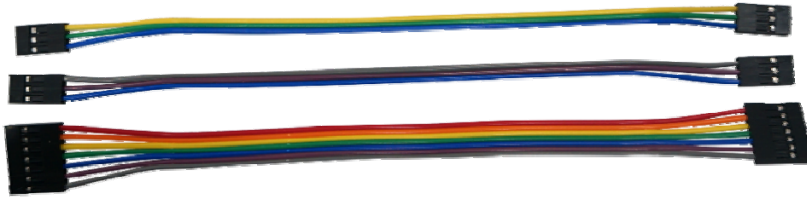

5.4.2 DC-DC module (BEC/UBEC), Input: DC 18-75V Output: DC 5V, 1200ma. It can convert main battery voltage to 5V output for receiver. If your ESC doesn't have built-in 5V power supply, you will need this module for receiver (this module needs to be purchased separately).

5.4.3 USB-TTL module is used to update receiver firmware. If you need this module, please purchase it separately.



6. Wireless charger

To ensure the waterproof effect, the remote(transmitter) only supports wireless chargers which meet Qi standard. The charger in the kit is shown in the figure below. Charging time is no more than one hour.



7. Switch on/off:

【 Switch on 】 When remote is off, long press the function button 1s, screen displays Maytech logo and



firmware version to switch on the remote.

【Switch off】 When remote is on, long press the function button 1.5s, screen displays POWER OFF to switch off the remote.

8. Function button operating instructions:

	Operation	Current display	Next display after the operation
Function Button	Long press	OFF	Long press 3S to switch on the remote
		Main interface	Long press 3S to switch off the remote
		Main menu or Sub-menu	Enter the sub-menu/ Data Setting Interface
		Pairing interface	Quit Pairing process
		Calibration interface	Quit Calibration process
		Wheel diameter/Gear ratio date setting interface	Select One hundred / Ten / One / Decimal place
	Short press one time	Main interface	Switch data display on main interface
		Main menu and sub-menu	Switch options in the menu
		Data input interface	Data plus one
	Short press two time	Main interface	Relay switch suction and release
	Short press three time	Main interface	Transistor switch ON and OFF

9. Throttle and brake triggers operating instructions:

Operation	The other trigger position	Current display	Throttle output
Press throttle trigger	Brake trigger at original position	Main interface	Output corresponding throttle signal
Press brake trigger	Throttle trigger at original position	Main interface	No throttle signal output
	Throttle trigger not at original position	Main interface of ESK8 mode	Receiver outputs brake signal. The braking force is determined by the position of the brake trigger.
	Throttle trigger at 10%-100% throttle position	Main interface of ESURF mode	After 3 seconds, it enters the cruise speed control mode, and the throttle keeps its original output after release. The cruise control will be cancelled when the brake trigger is pressed again to the end or the throttle trigger exceeds the cruise throttle value.

10. Data Source:

Speed signal is detected by motor phase wire or hall sensor wire or VESC. Please select **【Data Source】** in



remote manual Item6 and make sure hardware is connected correct and well. The original acquisition speed signal is the electrical speed of the motor (ERPM). Then remote will convert it to RPM or Speed and display.

Mode	Speed	Conversion formula
Esk8	Skateboard speed (KM/H)	$ERPM/Motor\ Poles/Gear\ Ratio*60*3.14*Wheel\ Dia/1000000$
	Skateboard speed (MPH)	$ERPM/Motor\ Poles/Gear\ Ratio*60*3.14*Wheel\ Dia/1000000*0.6214$
Esurf	Esurfboard propeller RPM (RPM)	$ERPM/Motor\ Poles/Gear\ Ratio$

11. Distance:

11.1 This function only works in Esk8 mode for electric skateboard.

11.2 When **【Data Source】** is set to **【Motor Wire】** or **【Hall Sensor】**, the distance is the accumulation of the product of speed and time per 0.1 second.

11.3 When **【Data Source】** is set to **【VESC】**, remote and receiver will read VESC's ABS data by UART port and calculate it to distance and display.

11.4 When you want to reset Distance, select **【12. Dist. Rst.】** and long press Function button, then Distance will start from 0.

12. Main battery voltage display:

12.1 This function works in both Esk8 and Esurf modes.

12.2 When **【Data Source】** is set to **【VESC】**, it will obtain VESC voltage information by UART port; Otherwise, voltage information is obtained by BAT port on receiver PCB.

12.3 Please make sure receiver GND and your main battery GND are connected(common ground).

12.4 If receiver is not connected to main battery or VESC UART port, remote will not display anything about main battery.

12.5 If receiver gets voltage information, remote will show voltage in bars according to preset **【 Batt. Type】** and **【Batt. Ser Num】**.

Under the voltage bar on remote screen, it's marked **【xx Batt.】**. "xx" means current **【Batt. Ser Num】** value, please check if it's same as your battery specification.

If **【 Batt. Type】** or **【Batt. Ser Num】** is set different from your battery's actual value, voltage display will be incorrect. Please make sure correct settings of both.

If voltage bars only have 2 or less left, the bars and **【xx Batt.】** words on screen will flash to remind you charge your battery.

13. Voltage, Current, Temperature display:

13.1 When **【Data Source】** is set to **【VESC】**, Remote and receiver will obtain voltage/current/temperature information by VESC UART port. The function automatically takes effect after correct connection and settings with VESC. You can press the Function Button to turn over the main interface data to view these data. Please refer to "Item 5.2" in this manual.

13.2 It works for both Esk8 and Esurf modes when use with VESC.

13.3 VESC has temperature sensitive resistor on PCB. It can measure VESC's temperature. But motor temperature display needs:

13.3.1 Motor has built-in 10K NTC thermistor and it's connected to the Temperature pin of hall sensor connector.

13.3.2 In VESC_TO0, Beta Value for Motor Thermistor is set to 3950K.

14. Relay and Transistor switches using instructions:



14.1 Both switches work in Esk8 and Esurf modes.

14.2 When relay switch is in original position(no display of【1】in Screen Main interface) , COM(common point) and CLO(normally close) are connected.

14.3 When relay switch is moved (display of 【1】 in Screen Main interface) , COM(common point) and OPE(normally open) are connected.

14.4 Max current of relay switch contacts is 3A. Recommend use this switch for water pump or main lighting system.

14.5 When Transistor switch is turned on, the load circuit will be connected to the GND terminal. Max current 2A. Recommend to use it for indicator LED.

14.6 When transistor switch is on (display of 【2】 in Screen Main interface), transistor switch source will be connected to GND and turn on LED. When it's off(no display of 【2】 in Screen Main interface), LED is off.

14.7 Recommend 5-12V voltage for the transistor switch. Voltage over 20V will burn the transistor.

14.8 Transistor switch pin SW1 is closed to BAT pin and MOT pin. Please make sure no electrical contact between them. Or it will burn transistor.

14.9 When controlling the LED by relay switch and transistor switch, you should consider whether there is a current limiting resistance inside the LED. If it is not, please connect one current limiting resistance outside, or it will burn the LED.

15. VESC throttle control type

15.1 When use VESC and UART for throttle output, VESC will automatically identify your remote throttle settings. It has two modes:

15.2 【Current Mode】 take motor current as control target. When release the trigger, it will free slide and has no danger. For normally electric skateboards and surfboards, recommend this mode.

15.3 【Duty Cycle】 take motor RPM as control target and motor RPM will increase as throttle increase and decrease with throttle decrease. When release the trigger and it will instantly brake down to zero and throw people off because of inertia. This mode is only suitable for differential control similar to tank operation.

16. Display:

16.1 Throttle percentage (Main interface after remote switch-on):

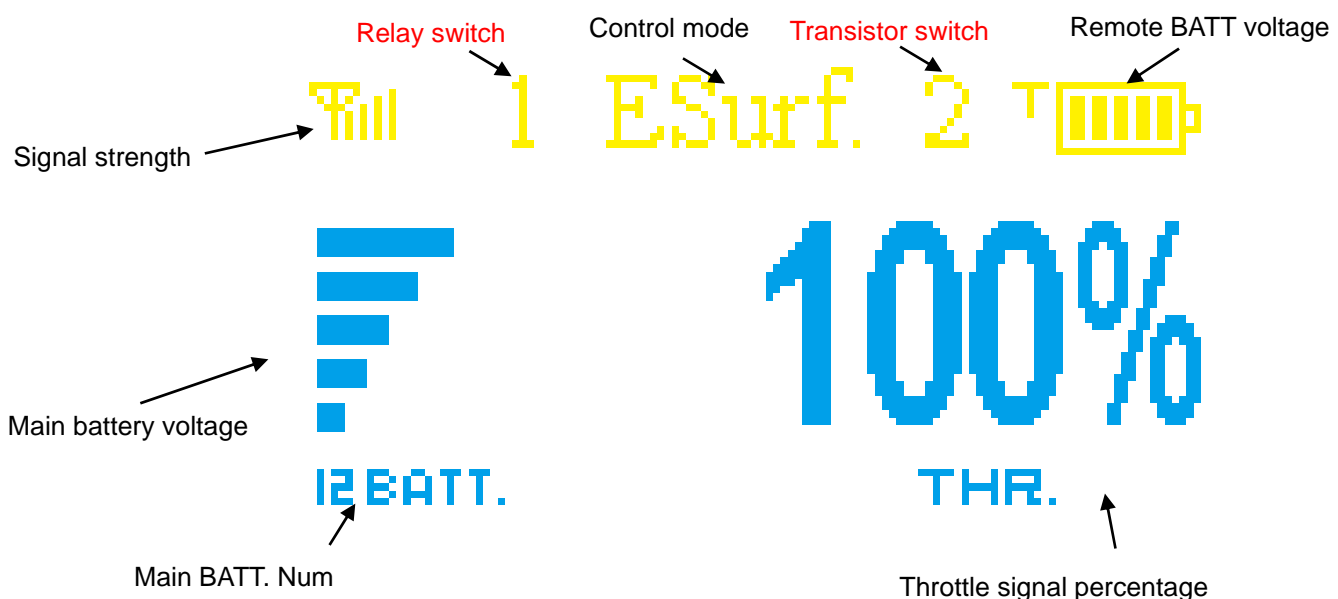

16.1.1 【Signal strength】 Signal strength between remote and receiver. Recommend that the direct distance between them is no more than 10 meters in air and no more than 1 meter in water.

16.1.2 【Remote BATT voltage】 The voltage percentage of the remote built-in lithium battery.



【BATT. Num】 Main Batt. Series Number.

16.1.3 【Main battery voltage】 The voltage is measured by receiver or obtained by VESC. The receiver reports the main battery voltage to the remote, which displays the power ratio of the main battery according to the preset number of battery. If your main battery electricity is used up, the bars and 【xx Batt.】 words on screen will flash to remind you charge your battery.

Attention:

When Data Source is not set to VESC, If receiver is not connected to main battery, remote will not display anything about main battery;

When Data Source is set to VESC, it will obtain VESC voltage information automatically.

16.1.4 【Control mode】 ESK8-Electric skateboard mode, ESurf-Electric surfboard mode.

ESK8: Neutral position, PWM output 1500 microsecond;

Press throttle trigger, PWM output range 1500-2000 microsecond;

Press brake trigger, PWM output range 1500-1000 microsecond;

Press two triggers together, the brake trigger gets priority output.

ESurf: Neutral position, PWM output 1000 microsecond;

Press throttle trigger, PWM output range 1000-2000 microsecond;

When Throttle trigger is at 10%-100% throttle position, long press brake trigger enter cruise speed control mode(please refer to “Item 9” in this manual) .

16.1.5 【Throttle signal percentage】 Value of the current output PWM signal percentage. In ESK8 mode, display range is ±100%; in ESurf mode, display range is 0-100%.

When VESC Thr is set to None, receiver’s PWM_T output PWM signal as throttle signal.

When VESC Thr is set to Current/Duty Cycle, receiver’s TXD/RXD output signal to VESC RX/TX as throttle signal .

16.1.6 【Relay switch】 Refer to “Item 8” in this manual.

16.1.7 【Transistor switch】 Refer to “Item 8” in this manual.

16.2 Esurf mode Motor RPM display:

In Esurf mode, after selecting suitable Data Source, when screen displays main interface, short press Function Button, it will change to Motor RPM interface. For different Data Source, text in the lower right corner is different.



Motor RPM is detected by one Motor phase wire.

Full 1 ESurf. 2 T

01234
RPM
12BATT. H.SE R.SPEED

Motor RPM is detected by one hall sensor wire.

Full 1 ESurf. 2 T

01234
RPM
12BATT. VESC R.SPEED

Motor RPM is obtained by VESC.

16.3 Esk8 mode Speed and Distance display:

16.3.1 In Esurf mode, it only has the motor RPM interface of real time RPM of propeller. It can't display speed and distance.

16.3.2 In Esk8 mode, after selecting suitable Data Source, when screen displays main interface, short press Function Button, it will change to Speed interface, press again, it will change to Distance interface.

16.3.3 You can set the unit Km&KM/H or Mile&MPH for Speed&Distance.

16.3.4 For different Data Source, text in the lower right corner is different.



Speed is obtained by VESC and showed in KM/H.



Distance is calculated based on RPM detected by one motor phase wire and showed in Mile.

16.4 Voltage and Current display:

For both Esurf and Esk8 modes, the interface must be displayed after selecting **【VESC】** in **【Data Source】**. Data is obtained from the VESC via the UART port. The voltage shows the current value and the minimum value after running. The current shows the current value and the maximum value after running.

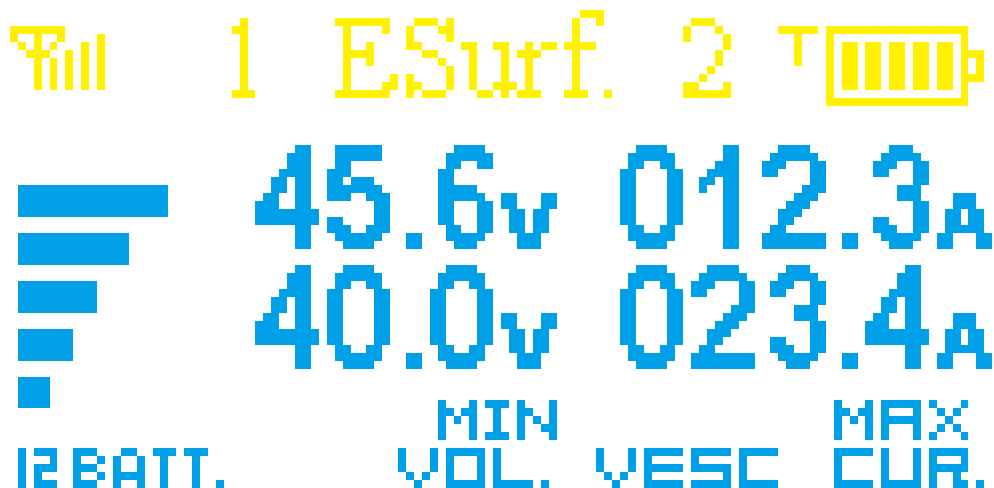

16.5 VESC temperature and motor temperature display



For both ESurf and Esk8 modes, the interface must be displayed after selecting **【VESC】** in **【Data Source】**. Data is obtained from the VESC via the UART port. It shows the current value and the minimum value after running.



17. Entry and Exit Main Menu

【Entry Main Menu】 Hold brake trigger to the end and press Function button.

【Exit Main Menu】 When the parameters are edited, press the brake to the end, exit from the sub-menu to the main menu, and then press again to exit from the main menu to the main interface. Special case: when set "Calibration", trigger will be occupied, please long press function button to exit from Calibration sub-menu to main menu.

18. Main Menu Description

The screenshots show the following menu options:

- >1. Thr. Mode**
- 2. Batt. Type**
- 3. Batt. Ser Num**
- 4. Pair**
- >5. Calibration**
- 6. Speed Source**
- 7. Motor Poles**
- 8. Wheel Dia.**
- >9. Gear Ratio**
- 10. Dist. Unit**
- 11. VESC Thr.**
- >12. Dist. Rst**

Main Menu has 12 options, with specific parameters in the sub-menu under each option:

1	Thr. Mode	Control mode	【Select options in Main Menu】 Short press function button, jump to the next option; Long press function button, select current option and enter sub-menu.
2	Batt. Type	Main battery type	
3	Batt. Ser Num	Main battery Series Number	
4	Pair	Pair remote and receiver	
5	Calibration	Remote throttle calibration	
6	Data Source	Data Source	
7	Motor Poles	Motor pole pairs	
8	Wheel Dia.	Wheel diameter	



9	Gear Ratio	=Wheel pulley/motor pulley	
10	Dist. Unit	Distance and Speed unit	
11	VESC Thr.	VESC throttle control type	
12	Dist. Rst	Reset Distance to Zero	

19. Sub-Menu Description

19.1 Thr. Mode

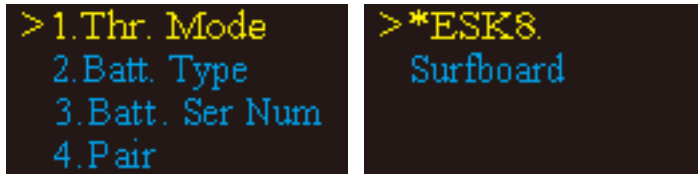

Select **【>1.Thr. Mode】** and long press function button for 1 second to enter Sub-menu.

【ESK8.】 Electric skateboard mode

【Surfboard】 Electric surfboard mode

Please refer to “Item 16. Display” to check the two modes details:

Short press function button to select control mode. Mode with * is current mode, Mode with >is selected mode. Long press function button to move * to the mode you wanted. After setting, press brake trigger back to main menu.

Default: Surfboard.

19.2 Batt. Type



Select **【>2.Batt.】** and long press function button for 1 second to enter Sub-menu.

【3.2V】 Lithium-ion ferrous phosphate batteries; 3.2 V per cell.

【3.7V】 Lithium ion or lithium polymer batteries; 3.7 V per cell.

The full voltage of the main battery can be obtained by matching this parameter with “3. Batt. Num”. According to the collected actual voltage , it will calculate the percentage of power, display it on the top of the home screen.

Short press function button to select control mode. Mode with * is current mode, Mode with >is selected mode. Long press function button to move * to the mode you wanted. After setting, press brake trigger back to main menu.

Default: 3.7 V

19.3 Batt. Ser Num

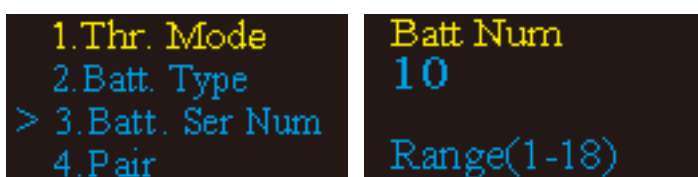

Select **【>3.Bat.Num】** and long press function button for 1 second to enter Sub-menu.

Press function button to add Battery number. Max number is 18.

Press brake trigger to save number and return to main menu.



Default: 10

19.4 Pair

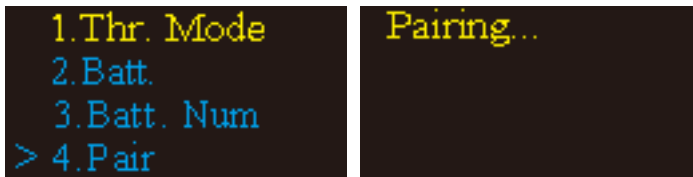

1. If remote and receiver are paired successfully before, then no need to pair them again.

2. If remote and receiver does not get paired before, please pair them according to below steps:

1) Turn off receiver.

2) Select 【>4.Pair】 and long press function button for 1 second to enter pair status. When screen shows 【Pairing...】 , turn on receiver and it will auto-pair with remote control in 0.5 second. Red led lights steady. Pairing completed. Remote screen will automatically return to main menu.

If auto-pairing time is over 1 second and screen still shows 【Pairing...】 , pairing fails and it needs to turn off and turn on receiver again to pair them. If you don't want to continue the pairing process, long press function button to exit to main menu.

19.5 Calibration

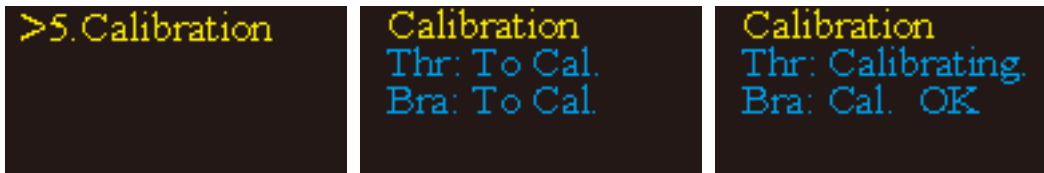

Due to environmental changes during use, remote calibration may be out of proportion to the output of PWM signal. Then it needs to do calibration.

Select 【>5.Calibration】 and long press function button for 1 second to enter Sub-menu. **Once enter calibration, it must need to be finished.** If don't continue calibration and exit, remote and receiver will stop working together.

Press throttle trigger to top and loose it. Then press brake trigger to top and loose. When press trigger, the screen will prompt 【Calibrating】 and 【 Cal. OK】 .

After both two are 【 Cal. OK】 , long press function button to return to main menu and save the results.

19.6 Data Source

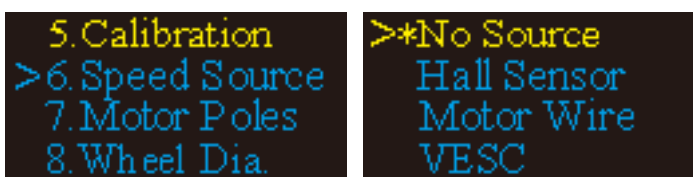

This is an important parameter. If you want to show RPM or Speed&Distance in Esurf or Esk8 mode, please select suitable Data Source in here.

Select 【>6.Data Source】 and long press function button for 1 second to enter Sub-menu.

【No Source】 No Data Source, remote screen will not display any information of RPM/Distance/Voltage/Current/Temperature.

【Hall Sensor】 The motor ERPM is detected by the state change of the Hall sensor.

【Motor Wire】 The motor ERPM is detected by the motor phase wire back electromotive force.

【VESC】 Read all kinds of valid data from VESC through UART port.

Default: No Source.

19.7 Motor Poles (Motor pole pairs)

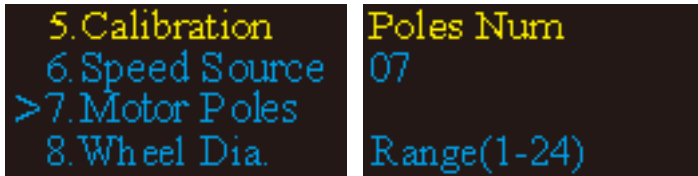

Be sure to note that the “Poles” here are actually Pole Pairs! This data is used to calculate motor speed(or RPM) based on motor ERPM, please refer to “Item 10”.

Press function button to add pole pairs number. Max number is 24.

Press brake trigger to save number and return to main menu.

19.8 Wheel Dia

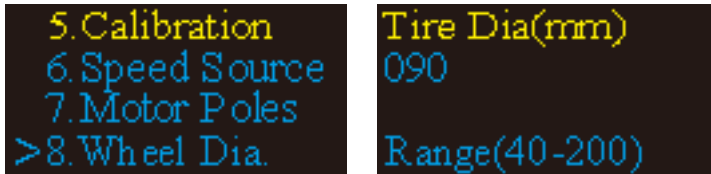

This data is only valid in Esk8 mode. It's to calculate speed and distance. Please refer to “Item 10”.

Long Press function button to select digit; Short press function button to add number.

Press brake trigger to save number and return to main menu. **19.9 Gear Ratio**

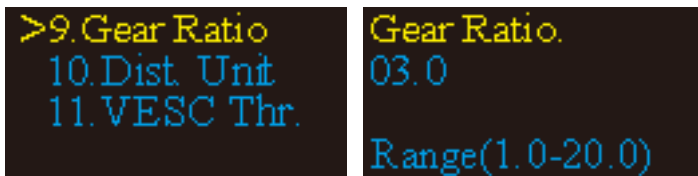

Gear Ratio=Motor RPM÷Propeller or Wheel RPM. It's to calculate speed and distance. Please refer to “Item 10”.

Long Press function button to select digit; Short press function button to add number.

Press brake trigger to save number and return to main menu.

19.10 Dist. Uni

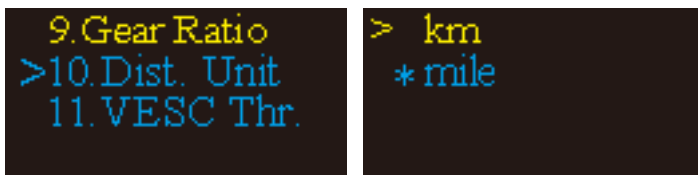

Available units: km and mile. After selecting, speed unit will change to KM/H and MPH correspondingly.

19.11 VESC Thr.

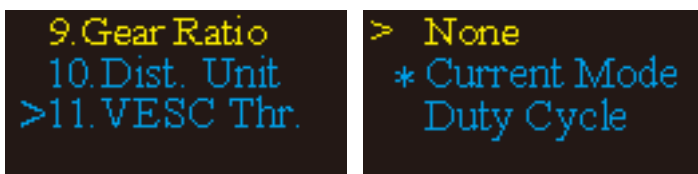

19.11.1 If select Current mode or Duty cycle mode, it will automaitcally open UART port communication.

After connecting hardware, please set following 2 parameters in VESC_TOOL:

APP Setting>>General>>APP to USE>>UART / PWM and UART;

APP Setting>>UART>>Baudrate 115200 bps

19.11.2 Current mode throttle of the VESC is controlled by the motor current. To get good throttle linearity, the maximum current must be set in VESC_TOOL to match the maximum current actually needed. Too low maximum current will cause too low speed even with top throttle and the maximum power of the motor will not be reached. Too high maximum current will cause motor getting max speed with



50% throttle. 50%-100% throttle has no effect.

19.11.3 The benefit of the Current Mode is when release throttle, the motor is free to coast without risk, so this is the common throttle mode for skateboards and surfboards.

19.11.4 In the Duty Cycle mode, the VESC takes the speed of the motor as the control target. When the throttle is released to the initial position, the motor will stop immediately. It is possible to throw people off skateboards or surfboards. This mode is only available for differential-controlled robotic carts.

19.12 Dist. Rst



Select **【>12.Dist. Rst】** and long press function button to reset the distance to zero.

20. Charging

- When remote battery icon  has 2 or less bars, it needs to charge the remote. Please keep remote dry when charging.
- Connect wireless charger to power, put remote Charging Point right on the wireless charger; it will automatically charge after 2 seconds.
- Remote screen will show charger input voltage “Input” and current battery voltage “Batt.”.

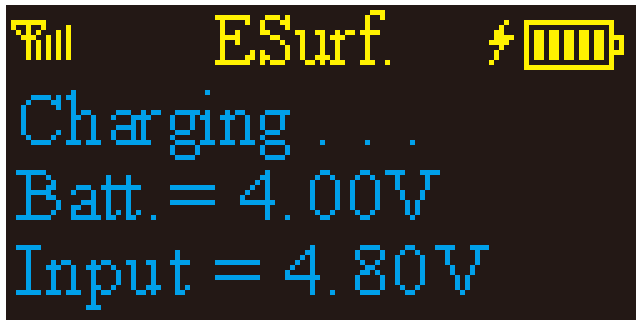

- When remote battery gets to 4.2V, it will stop charging automatically. The screen displays voltage data all the time and will not shut down automatically. Please don't put remote on charger for long time after full-charged!
- Charging without supervision is prohibited!
- When the remote control is not used, please charge it once a month, otherwise the battery life will be shortened or even scrapped due to long-term power loss.

20. Firmware update (to be updated)

21. Some functions for your reference:

1. Use Relay switch as safety switch:



冲浪板电调与接收机全功能连接图，继电器做安全开关

