

User Manual

Indoor FHD IP Camera



Model: C2M

Table of Contents

Security Warning	1
1 Overview.....	1
1.1 Key Features.....	1
1.2 Read Before Use.....	2
1.3 Package Contents.....	2
1.4 Physical Description.....	3
1.5 Hardware Installation	4
1.6 Micro-SD Card	4
2 Access the IP Camera.....	5
2.1 Wired Connection via Foscam App.....	5
2.2 Wired Connection via PC.....	6
2.3 Wireless Connection	7
2.4 Access the Camera in WAN.....	8
2.5 Using the VLC player	9
2.6 IP camera connection to the server	11
2.7 Works with Alexa.....	11
3 Surveillance Software GUI	17
3.1 login Window.....	17
3.2 Setup Wizard.....	18
3.3 Surveillance Window.....	18
4 Advanced Camera Settings.....	22
4.1 Setup Wizard.....	22
4.2 Status	22
4.3 Basic Settings	24
4.4 Network	31
4.5 Video	39
4.6 Detector.....	42
4.7 Record.....	46
4.8 Firewall	50
4.9 System	51
5 Playback	55
6 Appendix.....	57
6.1 Frequently Asked Questions	57
6.2 Default Parameters	67
6.3 Specifications	67
6.4 CE & FCC	68
6.5 Warranty.....	69
6.6 Statement	72
7 Obtaining Technical Support	73

Security Warning

1. Please change the password of your camera regularly, using a combination of numbers, letters and special characters.
2. We recommend that you regularly update your camera to the latest available software and firmware versions to help ensure the best experience for your camera.

1 Overview

FOSCAM Indoor FHD IP Camera is an integrated wireless IP Camera with a color CMOS sensor which enable to view in Full High Definition resolution. It combines a high quality digital video camera, with a powerful web server, to bring clear video to your desktop and mobile devices no matter where by your local network or over the Internet.

These cameras support P2P function. Thanks to the P2P easy access technology, you don't need to do complicated Port Forwarding, you just need to scan the QR code on the bottom of the camera to connect it to smart phone, or input the UID on CMS software to realize remote access.

FOSCAM IP Camera provides users with more comprehensive controls over a monitored site. The camera supports H.264 video compression technology, dramatically reduces file size and saves network bandwidth.

The camera is based on the TCP/IP standard. A built-in WEB server inside which could support Internet Explorer simplifies the management and maintenance of your device is simplified by accessing the website of your camera through network.

The camera is designed for indoor surveillance with wide applications such as at home, in retail store and in office. Controlling the camera and managing images are simplified by using the provided web interface across the network in either wired or wireless way.

FOSCAM provides Smart Phone APP for Android and iPhone users, please search and install Foscam App named **Foscam** on App Store and Google Play for iOS and Android devices, then you can view your camera anywhere, anytime on your smart mobile devices.

1.1 Key Features

- Standard H.264 video compression algorithm to satisfy the transmission of full high definition video in narrow bandwidth network
- P2P feature for easy access
- 2.0 Mega-Pixel
- Support IE/Firefox/Google/Safari browser
- Support WPA-PSK and WPA2-PSK Encryption
- Wireless connection is compliant with IEEE 802.11b/g/n/ac WI-FI, up to 150Mbps
- IR Range up to 8m(26ft)

- Support image snapshot
- Support dual-stream
- Support Mirco SD Card storage up to 128GB
- Support IR-Cut auto switch
- Support two-way audio
- Support ONVIF protocols
- Multi-level users management with password protection
- Motion detection alert via email or upload image to FTP
- Provide free Android and iPhone APP for viewing live video provide free Central Management Software to manage and monitor multiple cameras
- Support record schedule
- Supports voice prompt
- Supports dual-band WI-FI
- Build-in magnet for mounting

1.2 Read Before Use

Please first verify that all contents received are complete according to the Package Contents listed below. Before the IP Camera is installed, please carefully read and follow the instructions in the Quick Setup Guide to avoid damage due to faulty assembly and installation. It also ensures the product is used properly as intended.

1.3 Package Contents

● IP Camera × 1	● AC Adapter × 1
● Quick Setup Guide × 1	● Power Line × 1

1.4 Physical Description

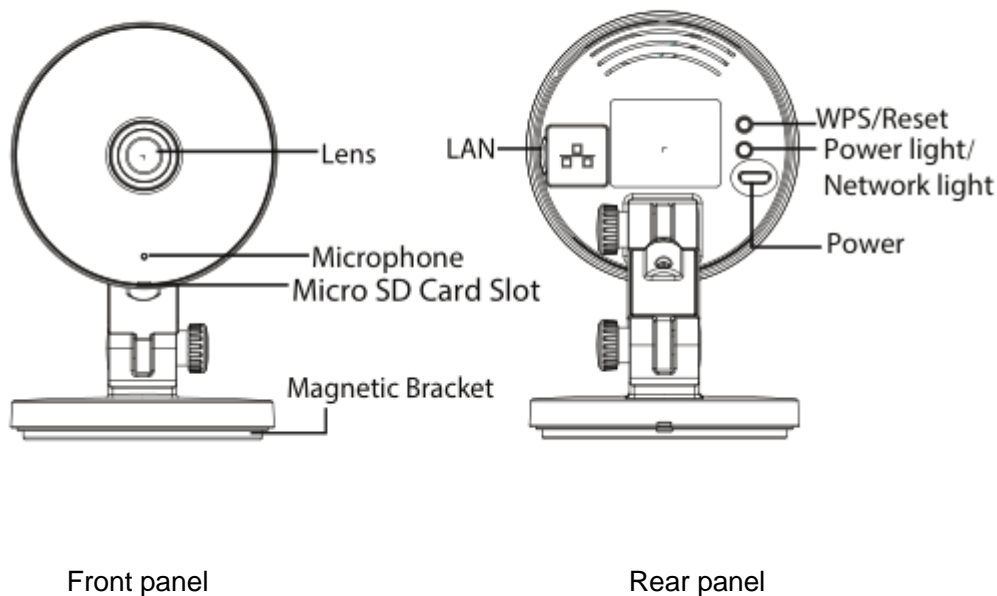

Front panel:

- LENS: Fixed focus lens. .
- Microphone: Built-in microphone.
- Micro SD Card slot: Supports up to 128GB SD card for storing the video.
- Magnetic Bracket: Adsorbing on a ferromagnetic object using a magnet on the base

Rear panel:

- Power Light: If the power supply works fine, the light will be on.
- LAN: 10/100 Mbps RJ-45 port for wired connection
- WPS/Reset
 - WPS: Push both WPS/Reset button on the camera and wireless router within 1 minute, the camera will connect to the wireless router automatically, in WPS process, the Network light will blink every 0.4 seconds;
 - Reset: Push and hold the WPS/Reset button for more than 10 seconds to set the camera to factory default, the Power light will blink every 0.4 seconds;
- Power: DC 5V/1A Power supply.

The flashing status of the Power/Network light are shown in the following table.

Flashing Status	Description
Flashing(red) every 0.4 seconds	Reset to take effect
Constant Flash(green)	Wired connection
Slow Flash(green) every 1.0 second	Wi-Fi connected
Flashing every(green) 0.4 seconds	WPS is connecting
Flashing every(green) 0.2 seconds	EZLink takes effect

1.5 Hardware Installation

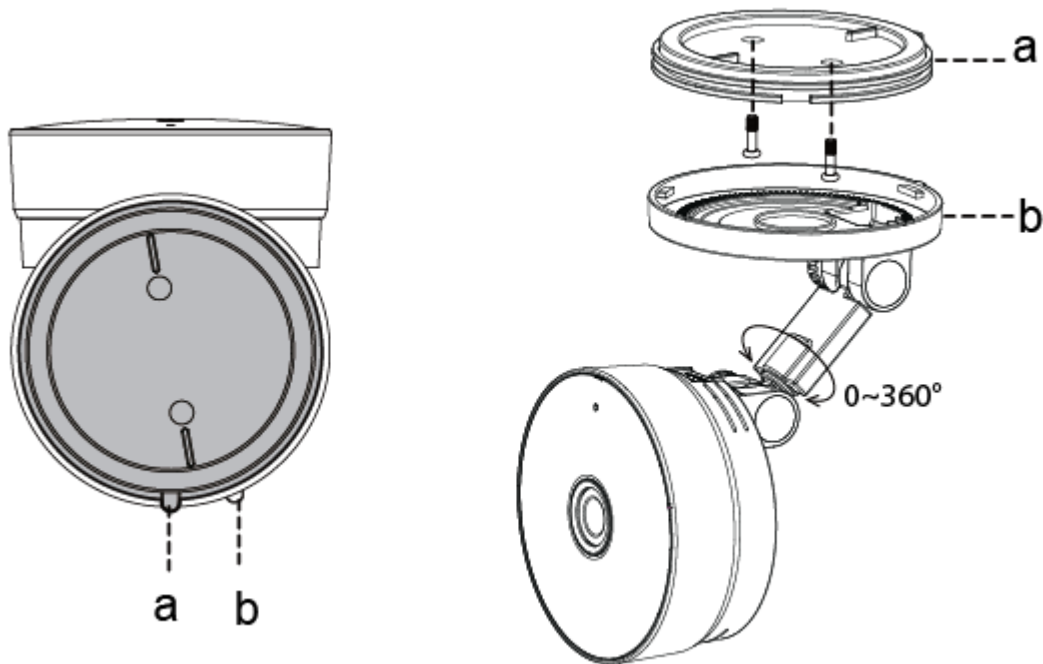

Step 1: Rotate the base of the camera until points a and b are aligned, this allows for the mounting plate be removed.

Step2: Install the mounting plate on a wall or ceiling with supplied fixing screws.

Step3: Align points a and b to insert the camera base to the mounting plate. Rotate so that points a and b no longer aligned, this attaches the camera securely to the base.

1.6 Micro-SD Card

This camera supports Micro SD Card.

When you plug in the Micro SD card during the camera work process, please reboot the camera again, or else the Micro SD Card may be cannot work well.

Go to the **Settings→Device Status→Device Status** page, you can see the SD card status.

2 Access the IP Camera

2.1 Wired Connection via Foscam App



Download and open the Foscam App from the App Store or Google Play Store. Once open, please register for a Foscam account, or sign in if you have one already.

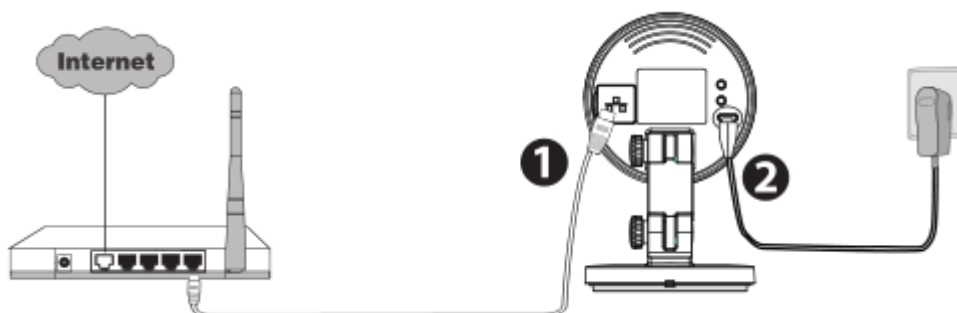

1. Connect the camera to your Internet router using an Ethernet cable.
2. Connect the power adapter to the camera, and wait for a few moments until the camera alerts you that the "Wired connection succeeded."
3. From your smartphone, search for "Foscam" via the App Store or Google Play Store. Download, install and open the App to begin configuration.
4. Open the App to begin configuration.
5. Under "Foscam" select "Tap to add a camera" and then select "Camera", after that scan the QR code, which is located at the bottom of your camera (see illustrations below).



Tap + button



Scan the QR code which is located at the bottom of your camera.



Confirm "Wired" and then tap "Ready for Wired Connection"



Camera added successfully!

2.2 Wired Connection via PC

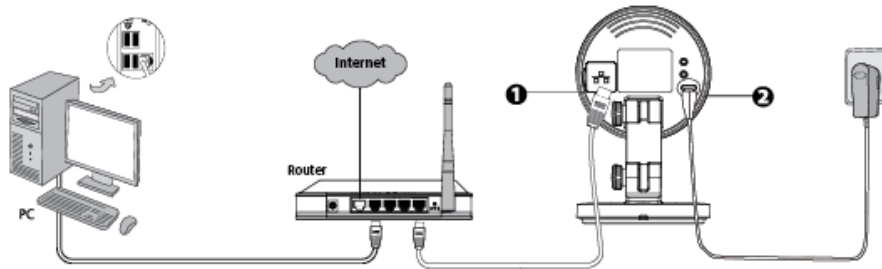

1. Connect the camera to the LAN network (Router or Switch) via network cable.
2. Connect the power adapter to the camera.
3. Visit Foscam official website <http://www.foscam.com> , select “[foscam.com/tools](http://www.foscam.com/tools)”, then you can find the “Equipment Search Tool”, download the tool to your computer, the icon shows as below:



The camera supports HTTP and HTTPS protocols, you can access the camera in two ways.

(1) [http:// LAN IP + HTTP Port NO.](http://LAN IP + HTTP Port NO.)

The default HTTP port NO. is 88. Double click the Equipment Search Tool icon to run, and it should find the camera’s IP address automatically after you plug in the network cable.

Camera Name	IP Address	Device ID	Type
Anonymous	Http://192.168.1.105:88	00626E55AB1E	IPC

Double click the IP address of the camera; the camera login page should be open in your default browser.

(2) [https:// LAN IP + HTTPS Port NO.](https://LAN IP + HTTPS Port NO.)

The default HTTPS port NO. is 443. You can use the URL to access the camera: [https:// LAN IP + HTTPS port NO.](https://LAN IP + HTTPS port NO.)

Go to **Settings - Network - Port** panel, you can see and change the HTTP and HTTPS port NO.

The screenshot shows the 'Port' settings panel. It has a 'Save' button and a 'Refresh' button. Below the buttons are two input fields: 'HTTP Port' with the value '88' and 'HTTPS Port' with the value '443'.

NOTE:

When logging in for the first time, you will need to download and install the add-on.

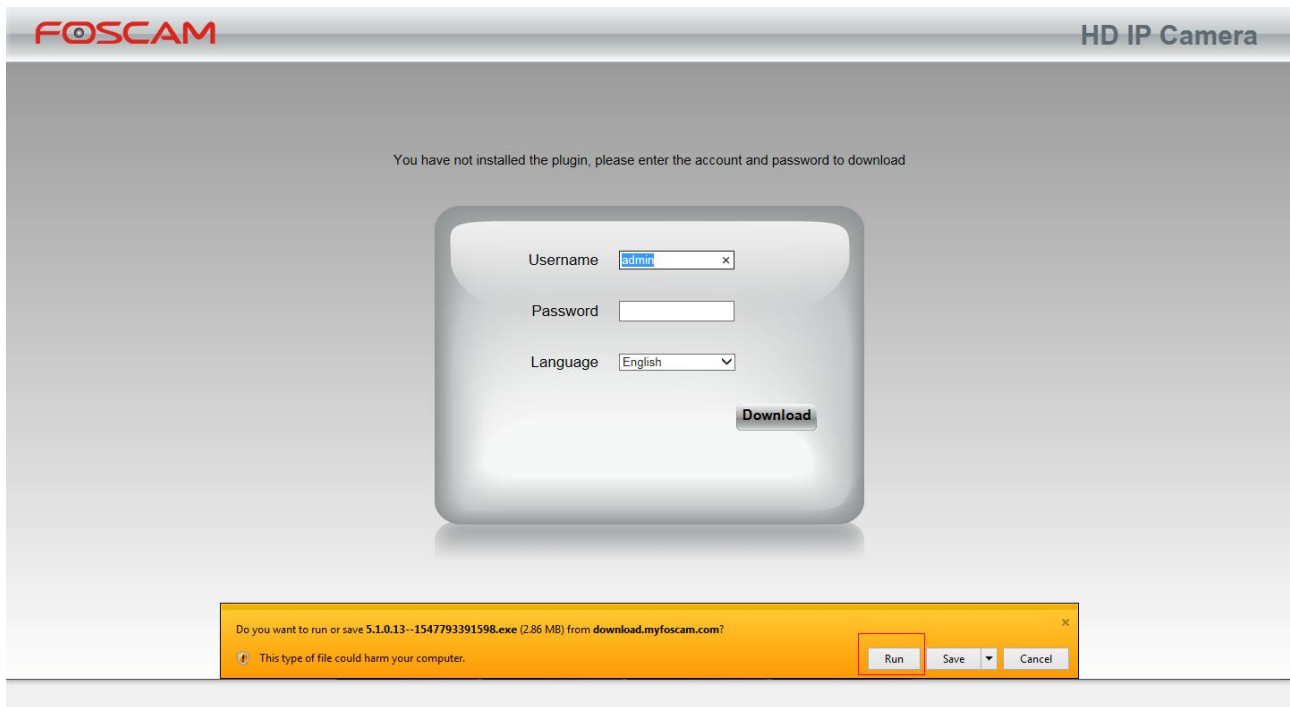

2.3 Wireless Connection

There are some ways of wireless connection: EZLink connection and WPS connection.

- **EZLink connection:** Use the mobile phones or other mobile devices to download APP, then connect the camera and the wireless router by the APP. The procedure of the EZLink connection, please refer to the Quick Setup Guide.
- **WPS connection:** WI-FI Protected Set-up, Press and hold the WPS button on your wireless router and your camera within 60 seconds. So that your camera and wireless router connect successfully.

2.3.1 WPS (WI-FI Protected Set-up)

Before using WPS wireless connection, you need to:

- Make sure that your wireless router has the WPS function.
- WPS button on the wireless router is typically located on the front panel or rear panel. TP-LINK router's WPS button is called QSS (Quick Security Setup).
- Make sure that the ethernet cable and the camera is disconnected.

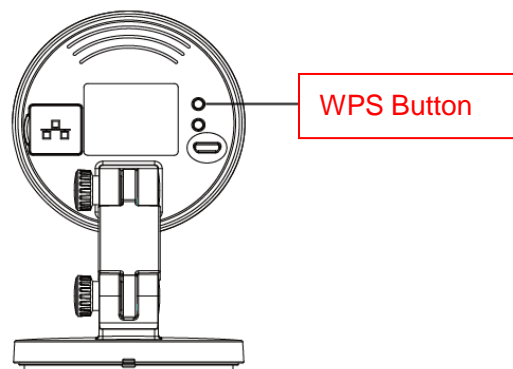

- (1) Press and hold the WPS button for three seconds. The Network light of the camera begins to twinkle at high frequency. (every 0.4 seconds)
- (2) Press and hold the WPS button for three seconds on your wireless router within 60 seconds. Then the camera will automatically create a secure wireless connection to your router in about 60 seconds.
- (3) The Equipment Search Tool will search the camera's LAN IP. Make sure the PC and the camera share the same subnet.

NOTE :

The security mode of router cannot be WEP, or else the WPS settings may be failed.

2.4 Access the Camera in WAN

2.4.1 Static IP Addresses

Users with static IP addresses after you have finished connecting the camera using the LAN IP address and port forwarding, you can access the camera directly from Internet using the WAN IP address and port number.

How to Obtain the WAN IP address from a public website ?

To obtain your WAN IP address, enter the following URL in your browser: <http://www.whatismyip.com>. Your current WAN IP will be shown on the webpage.



2.5 Using the VLC player

The camera supports RTSP streaming, here you can view the camera by VLC player.

RTSP URL [rtsp:// \[user name\]:\[password\]@IP:Port number/videostream](rtsp://[user name]:[password]@IP:Port number/videostream)

The part in the square brackets can be omitted.

user name & password: The user name and password to access the camera. This part can be omitted.

IP: WAN or LAN IP address.

Port NO. : If there is the RTSP port number on the Port page, you must only use RTSP port number. otherwise, you must only use http port number.

Video stream: Three modes are supported: video Main, video Sub and audio. Video Sub is a better choice in bad network condition. If you select audio, you can only hear sound without seeing picture.

For example:

IP: 192.168.1.11

RTSP Port number: 554

User name: admin

Password: 123

Enter either one of the following four URLs in the VLC

1. `rtsp://admin:123@192.168.1.11:554/videoMain`
2. `rtsp:// @192.168.1.11:554/videoMain`
3. `rtsp://:123@192.168.1.11:554/videoMain`
4. `rtsp://admin@192.168.1.11:554/videoMain`

Open the VLC, and go to "Media"--"Open Network Stream" option, then enter the URL in VLC.

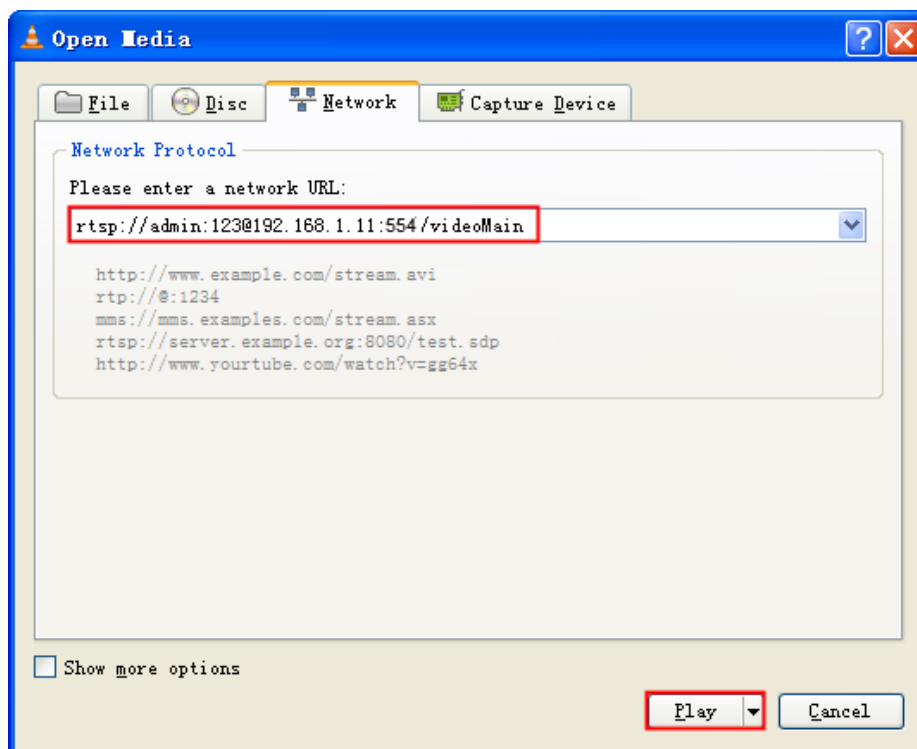
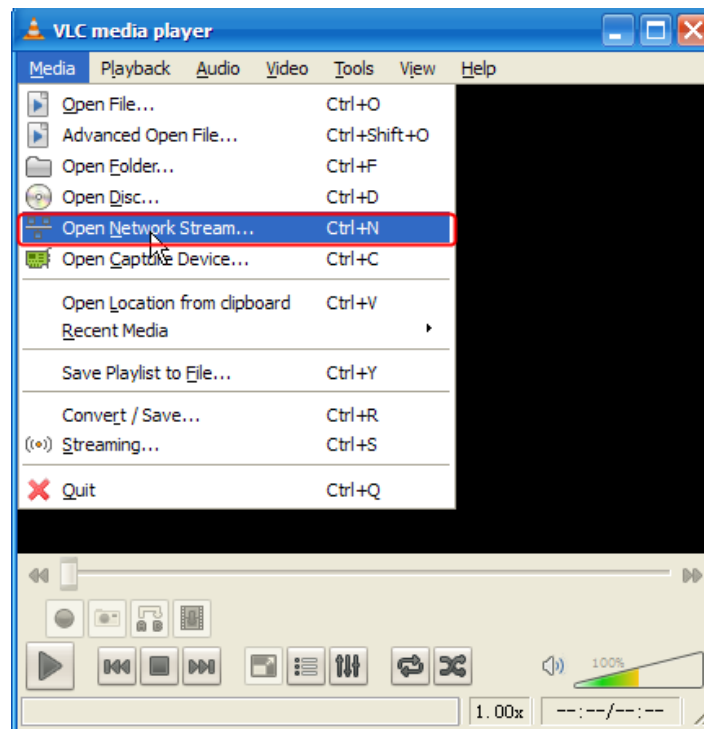

Sometimes you may need to enter the user name and password for another time. Click OK and you can see the real-time preview.

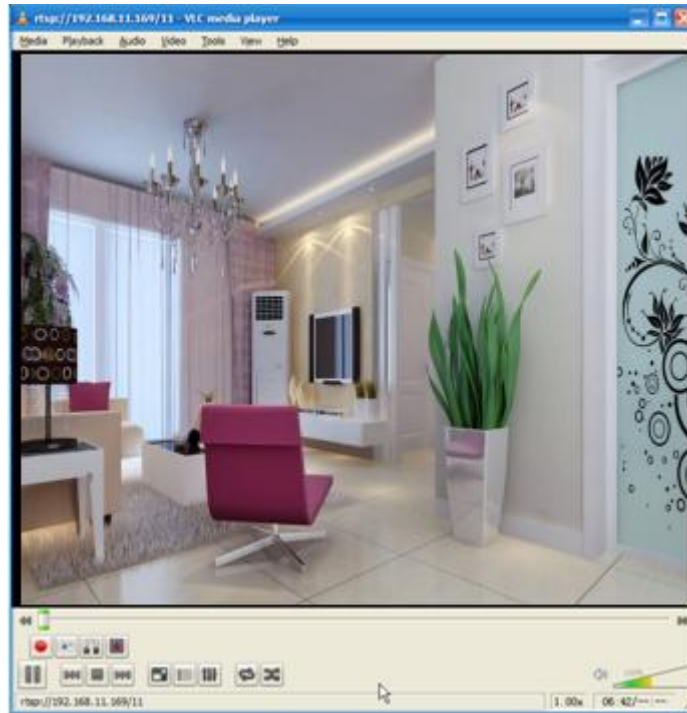
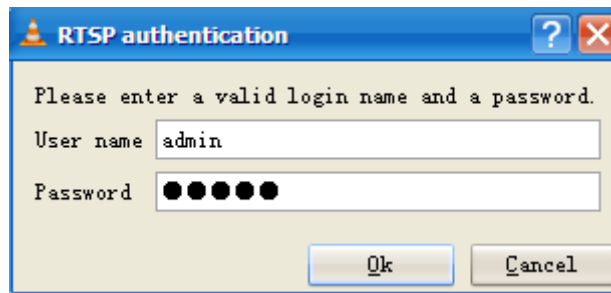

If you cannot play the video in the VLC player, please check the port mapping.

NOTE:

If you modify the camera's username or password, you had better reboot the camera to apply the new username and password in authentication in the VLC.

2.6 IP camera connection to the server

Device supports ONVIF 2.2.1 protocol, You can easily access NVR with ONVIF or server with ONVIF.

2.7 Works with Alexa

2.7.1 Introduction of the Foscam cameras working with Amazon's Alexa

Foscam cameras support live streaming on Amazon's Alexa device Echo show (all models) now. You only need to speak directly to the Echo show to get the camera's live stream shown up after completing some basic settings.

2.7.2 How to confirm if your Foscam camera supports working with Alexa or not?

1. The currently supported required firmware should be 2.x.2.10 or higher;
2. The Foscam app version should be 2.2.9 or higher.

2.7.3 How to confirm the host name of Alexa account?

1. Please login the Alexa app and go to "Settings".
2. Please choose "About".
3. Then you will see the host name of your Alexa account.

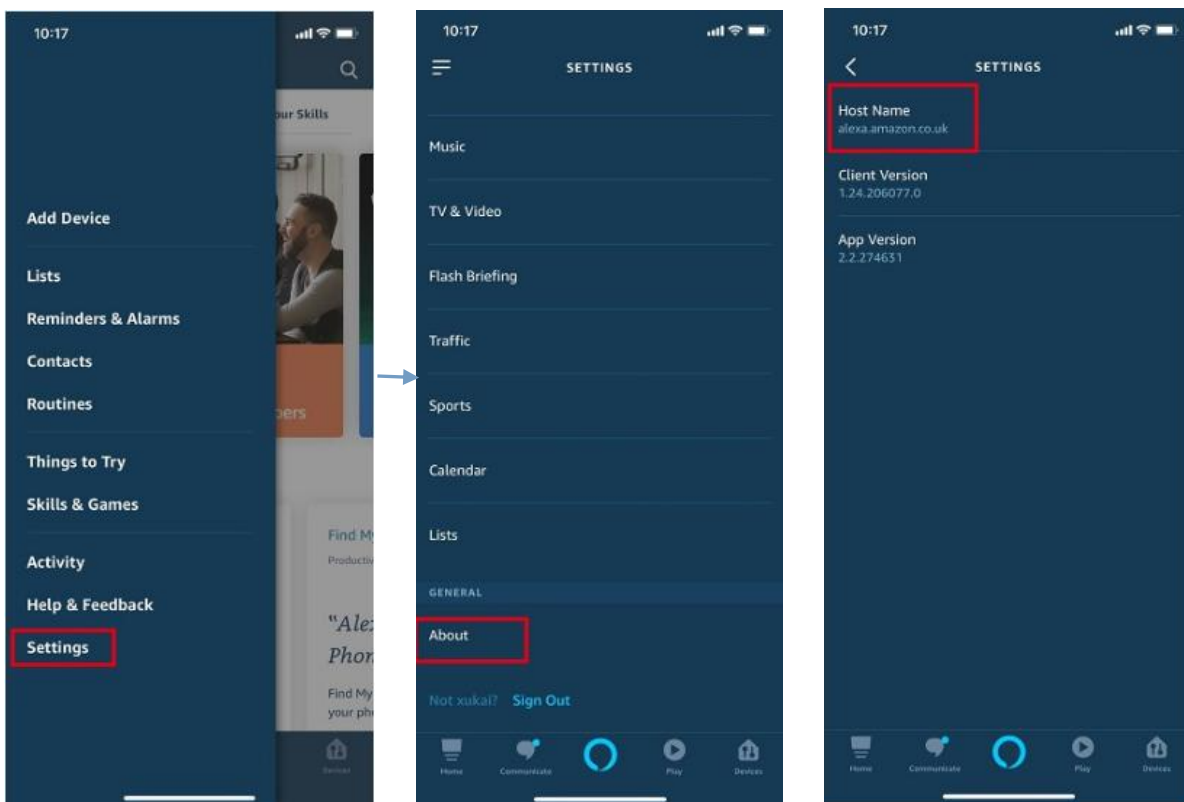

2.7.4 How to set up Foscam cameras working with Amazon's Alexa?

1. Please make sure your Foscam camera and Foscam app supports Alexa.
2. Please login the camera on Foscam app, go to camera settings-->Advanced Settings-->Smart Control to enable the "Work With Alexa" and set a name for your camera. It is not recommended to set the name with camera model. If you re-name your camera in the Foscam app, you will need to ask your Echo show to re-discover the camera in order for the new camera name to be refreshed in the Alexa app.

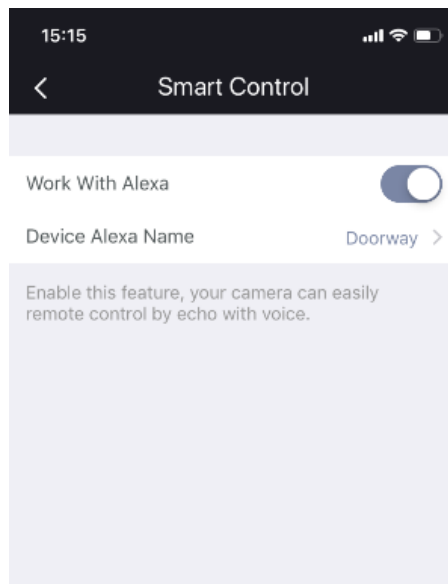

Note: How to confirm the host name of Alexa account?

3. Please choose the correct region according to your Alexa account's host name. If you are not sure what host name of your Alexa account is, please refer to [here](#).

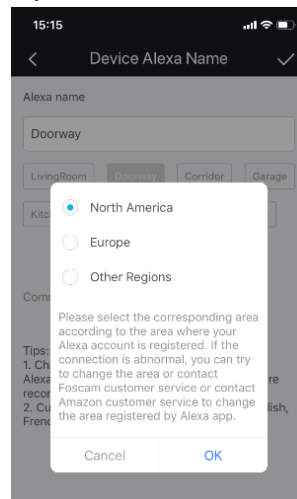

4. Please open the Alexa app to search for Foscam skill, enable to use it and link your Foscam account to the Alexa app.

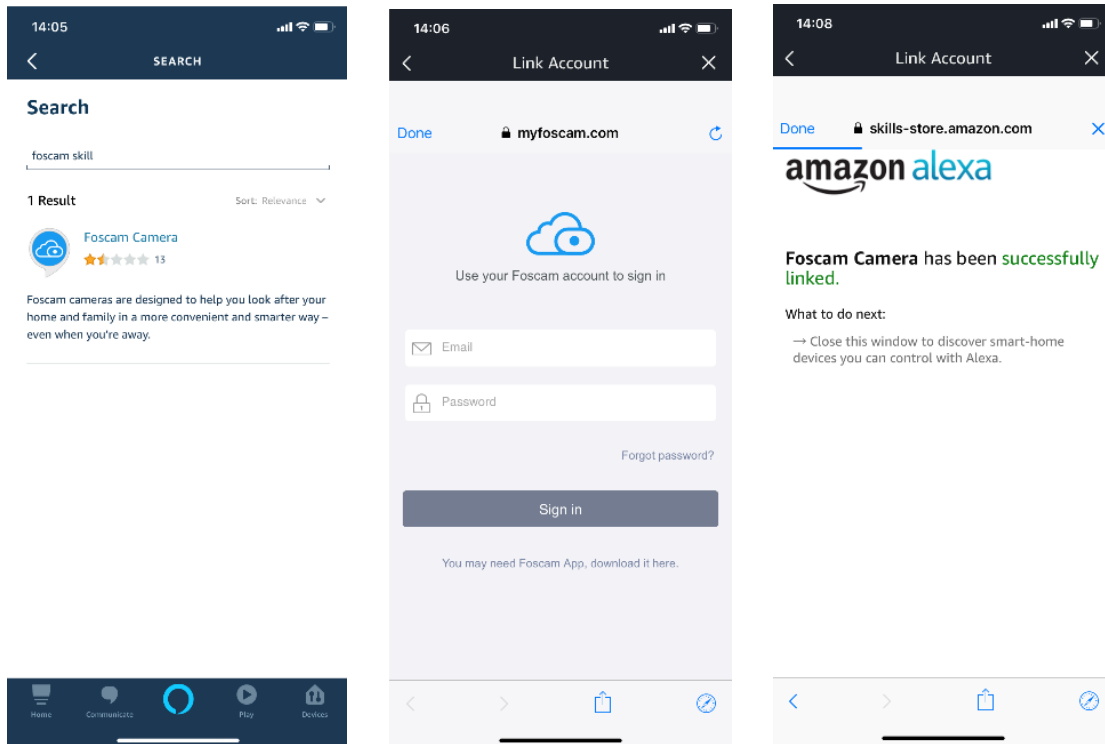

5. Then you can choose the option “DISCOVER DEVICES” to add Foscam camera to the Alexa app or speak “Alexa, discover devices” to the Echo show directly.



6. After camera is added to the Alexa app, you can speak directly to the Echo show to get the camera’s live stream shown up by voice command.

The voice commands:

Once your Foscam camera is connected to your Echo show, you can use the following voice commands to get and stop the camera’s live stream.

Get the live streaming:

"Alexa, show me the [camera name]"

"Stop the live streaming"

"Alexa, close."

Currently, Foscam cameras working with Amazon's Alexa supports English, French, German, Italian and

Spanish.

2.7.5 How to add Foscam cameras to Alexa app manually?

1. Please make sure you have enabled the “Work With Alexa” and set a name for your camera on Foscam app.
2. Please login the Alexa app and choose “Devices” and tap on “+” symbol.



3. Please choose “Add Device”.

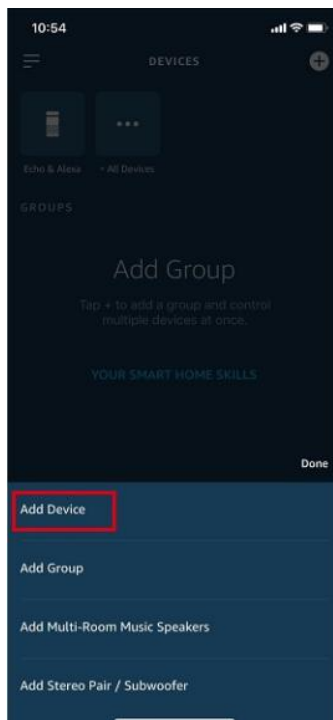

4. Please choose “Camera”. If there is no camera option, please choose “Other”.

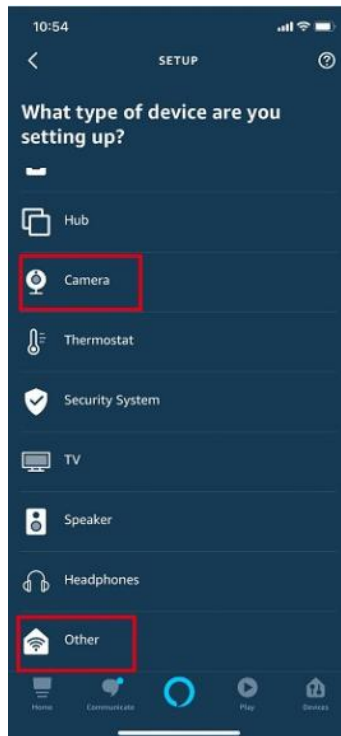

5. Please choose “DISCOVER DEVICES” to search for Foscam cameras. Then your camera will be added to the Alexa app.



3 Surveillance Software GUI

Please refer to the section 2.2 if you install the camera for the first time. You can start to learn about software operation in the computer

3.1 login Window

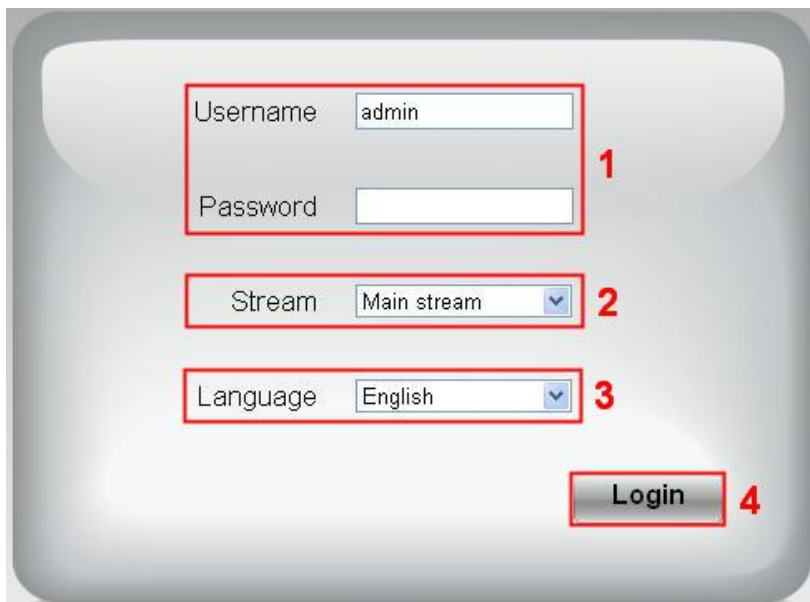

Section1 Enter the Username and password

The default administrator username is “admin” with no password, please change the password the first time you use and prevent unauthorized users login the camera.

Section2 Stream

The camera supports two stream modes: Main stream and sub stream. Select Main stream if you want to access the camera from LAN and sub stream will be better if you want to access the camera from Internet.

Note:

Select sub stream to ensure a more fluent video under narrow network bandwidth.

Section3 Select the language

You click on the language dropdown list to select language.

Section4 login the camera

Click “Login” button.

NOTE:

When setting up your camera for the first time, it will request that you modify the default username and/or password if both are still set to default. Input the new username and password, click "Modify" to complete the modification. You will now use the new username and password to login to the camera in the future.

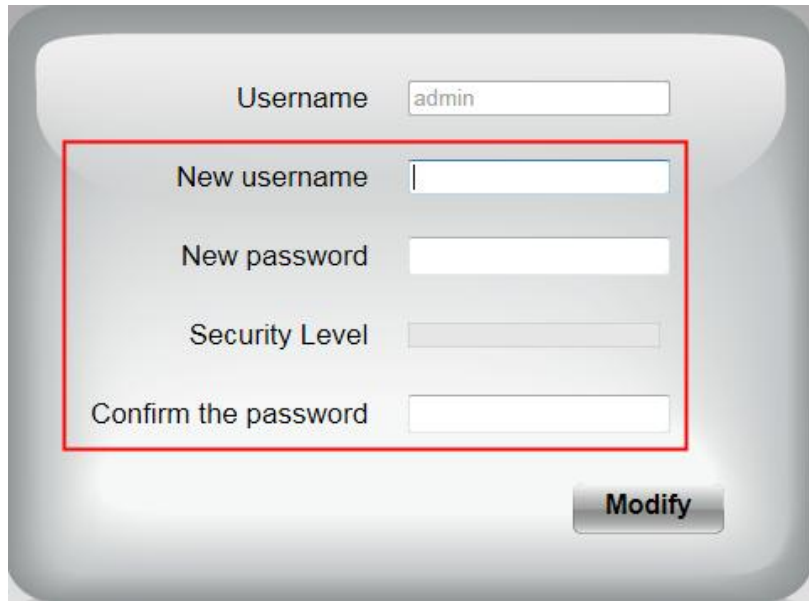

3.2 Setup Wizard

You will go to “Setup Wizard” automatically after your first-login, where you can set the basic parameters of camera, such as camera name, camera time, wireless settings, IP configuration.

3.3 Surveillance Window

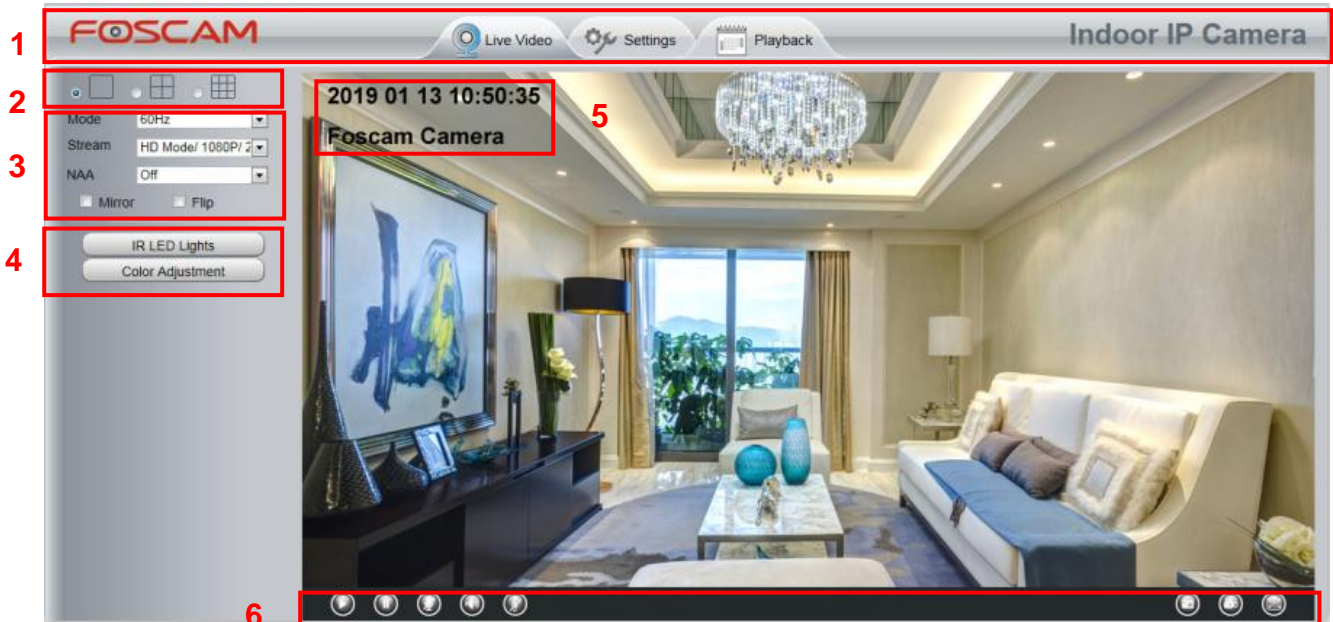

Section 1 FOSCAM Logo/ Live Video / Settings/Playback

FOSCAM: FOSCAM LOGO

LiveVideo: Path to surveillance window. Click this button to go back to the surveillance window



Settings: Path to Administrator Control Panel, Click it, to go to Administrator Control Panel and do advanced settings.



Playback: Click this button to go back to the Playback panel to view the stored audio files stored in the SD Card.

Section 2 Multi-Device Window



The firmware inside the camera supports up to 9 cameras being monitored at the same time. You can add other cameras in multi-device setting.

Section 3 Mode/ Stream / WDR / NAA /Mirror/ Flip buttons

● Mode

- 1) 50HZ -----Indoor surveillance (Region: Europe, China)
- 2) 60HZ -----Indoor surveillance (Region: USA, Canada)
- 3) Outdoor-----Outdoor surveillance

● Stream

The default stream supports multiple modes, For example: HD Mode/720P/23fps/2M meanings: Stream type / Resolution / Maximum frame rate/ Bit rate. (Different models support different specific mode.)

Stream type : It is used to identify the stream type.

Resolution

The bigger the resolution, the better of the image quality is. If you are accessing the camera via internet and want to get more fluent video streaming, please select resolution VGA.

Maximum frame rate

You should lower frame rate when the bandwidth is limited. Normally, when the frame rate above 15, you can achieve fluently video. The maximum frame rate for each model is different, please see the "Specifications".

Bit rate

Generally speaking, the larger the bit rate is, the clearer video will become. But the bit rate configuration should combine well with the network bandwidth. When the bandwidth is very narrow, and bit rate is large, that will lead to video can not play well.

You can reset the stream type on **Settings-> Video-> Video Settings** panel.

After changing, please reboot the camera and you can see the modification.

● NAA

NAA(Network Auto-Adaptability) can make IP camera change the real-time rate to adapt different network conditions. It can supply better preview experience. The default NAA setting is off.

Section 4 IR LED Lights / Color Adjustment



Click Infra led and there are three modes to adjust the infrared led: Auto, Manual and Schedule.

Auto: Select it and the camera will adjust the infra led (on or off) automatically.

Manual: Select it and you can turn on or turn off the infra led manually.

Schedule: Select it and the IR led light will be off at the schedule period. If you want to define or change the IR led lights schedule time, please go to **Settings--->Video---> IR LED Schedule** page.

Color Adjustment

In this page, you can tune Brightness, Contrast, Saturation, and Sharpness to get higher quality.

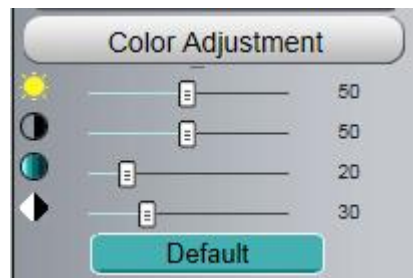

Section 5 OSD

If you have added time and camera name in the video, you can see it in the live window.

Go to **Settings ---Basic settings---Camera name** panel, and you can change another device name.

The default device name is anonymous.

Go to **Settings ---Basic settings---Camera time** panel and adjust the device time.

Go to **Settings ---Video---On Screen Display** panel, you can add or no add OSD.

Section 6 Play/ Stop/ Talk/ Audio/ Adjusting the sound/ Snapshot/ Record/ Full screen button



1---- **Play** Click it to play the video of the camera

2---- **Stop** Click it to stop the video of the camera

3---- **Talk** Click the button and the icon will become to , then talk to the microphone that connected with PC, people around the camera can here your voice. Click the icon again and stop talking.

4---- **Audio** Click this icon, the icon will become to  you can hear the sound around the camera by the earphone or speakers that connected with PC.

5----- Adjusting the sound Click this icon, the icon will become to  ,you can change the sound of the camera. (C2 only)

6----- Snapshot Click it to make snapshot and it pop-up a window which picture you snapshot, right click in the window and save the picture to anywhere you want.

7----- Record Click the icon  and the camera start recording, you can see a green dot in the live window. Click again and stop recording. The default storage path is C:\IPCamRecord. You can change the storage path: Go to Settings- >Record->Storage Location panel.

8----- Full Screen Click it to make full-screen, or you can double click the surveillance screen to make full-screen. Double click again and exit full-screen.

4 Advanced Camera Settings

Click the button “**Settings**”, goes to Administrator Control Panel to make advanced camera settings.

4.1 Setup Wizard

Please go to section 3.2 to find the way to set it.

4.2 Status

Status contains four columns: Device Information, Device Status, Session Status and Log, it will show you various information about your camera.

4.2.1 Device Information

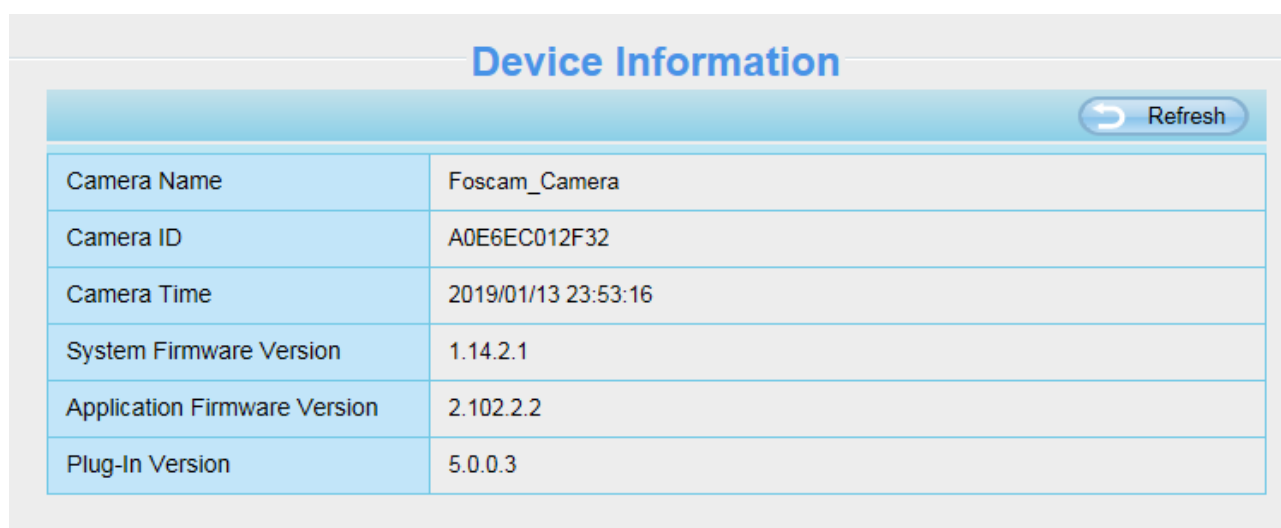

Device Information	
Camera Name	Foscam_Camera
Camera ID	A0E6EC012F32
Camera Time	2019/01/13 23:53:16
System Firmware Version	1.14.2.1
Application Firmware Version	2.102.2.2
Plug-In Version	5.0.0.3

Camera Name: The Device Name is a unique name that you can give to your device to help you identify it. Click **Basic Settings** and go to **Camera name** panel where you can change your camera name. The default device name is anonymous.

Camera ID: Display the wired MAC address of your camera. For example Device ID is A0E6EC012F32, the same MAC ID sticker is found at the bottom of the camera.

Camera Time: The system time of the device. Click **Basic Settings** and go to **Camera time** panel and adjust the time.

System Firmware Version: Display the System Firmware version of your camera.

Application Firmware Version: Display the application firmware version of your camera.

Plug-In Version: Display the plug-in version of your camera.

4.2.2 Device Status

On this page you can see device status such as Alarm status/ Record Status , WIFI status and so on.

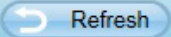
Device Status	
 Refresh	
Motion alarm status	No alarm
Sound alarm status	Disabled
Human Detection Alarm Status	Disabled
Recording Status	Not Recording
SD Card Status	No SD card
SD Card Free Space	0KB
SD Card Total Space	0KB
NTP Status	Failed
WiFi Status	Connected to:Xiaomi_49AB
IR LED Status	On

4.2.3 Session Status

Session status will display who and which IP is visiting the camera now.

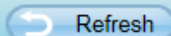
Session Status	
 Refresh	
Username	IP Address
1	192.168.1.100

4.2.4 Log

The log record shows who and which IP address accessed or logout the camera.

Pages:83				
NO.	Time	User	IP	Log
1	2012-09-18 02:11:45			
2	2012-09-18 01:48:56			
3	2012-09-18 01:29:51	admin	192.168.1.102	Log out
4	2012-09-18 01:27:54	admin	218.17.160.187	Log out
5	2012-09-18 01:26:21	admin	192.168.1.100	Log out
6	2012-09-18 01:25:42	admin	218.17.160.187	Login
7	2012-09-18 01:25:15	admin	192.168.1.102	Login
8	2012-09-18 01:25:13	admin	192.168.1.102	Log out
9	2012-09-18 01:24:46	admin	192.168.1.100	Login
10	2012-09-18 01:21:44	admin	192.168.1.102	Login

Reboot the camera and clear the log records.

4.3 Basic Settings

This section allows you to configure your camera's Name, Time, Mail, User account and Multi-Device.

4.3.1 Camera Name

You can define a name for your camera here such as apple. Click Save to save your changes. The alias name cannot contain special characters.

Camera Name

Save
Refresh

Camera Name	<input style="width: 90%;" type="text" value="Foscam_Camera"/> <p style="font-size: small; margin-top: 5px;">The maximum Device Name length is 20, support English, numbers, letters and symbols</p>
-------------	--

4.3.2 Camera Time

This section allows you to configure the settings of the internal system clocks for your camera.

Save Refresh	
Time Zone	(GMT) Greenwich mean time; London, Lisbon, (
Sync with NTP server <input checked="" type="checkbox"/>	
NTP Server	Auto
Device Time	2016-4-26 08 : 15 : 53 Sync with PC/Terminal
Date Format	YYYY-MM-DD
Time Format	24-hour
use DST <input checked="" type="checkbox"/>	
From	April first Sunday 2 : 00
To	October the last one Sunday 2 : 00
Ahead Of Time	0 Minute

Time Zone: Select the time zone for your region from the dropdown menu.

Sync with NTP server: Network Time Protocol will synchronize your camera with an Internet time server. Choose the one that is closest to your camera.

Sync with PC: Select this option to synchronize the date and time of the Network Camera with your computer.

Manually: The administrator can enter the date and time manually. Note select the date and time format.

use DST: Select the daylight saving time from the dropdown list.

Click **Save** button and submit your settings.

NOTE: If the power supply of camera is disconnect, you need set the camera's time again.

4.3.3 User Accounts

Here you can create users and set privilege, **visitor**, **operator** or **administrator**. The default user account is admin, with a blank password. You can enter the users accounts of visitor, operator and administrator Manually.

User Accounts

Refresh

NO.	Username	Privilege
1	1	Administrator
2		
3		
4		
5		
6		
7		
8		

Username
 Privilege
 Change username
 Change password

The maximum username length is 20, including numbers, letters and symbols _ - @ \$ *
 The maximum password length is 12, including numbers, letters and symbols ~ ! @ # % ^ * () _ + { } : " | < > ? ' - ; ' \ , . /

How to change the password?

Firstly, select the account which you want to change the password, then select “Change password”, enter the old password and the new password, lastly click modify to take effect.

User Accounts

Refresh

NO.	Username	Privilege
1	foscam	Administrator
2	admin	Administrator
3		
4		
5		
6		
7		
8		

Username
 Password
 New username
 New password
 Password Security Level
 Confirm the password
 Privilege
 Change username
 Change password

The maximum length of the user name is 20, support numbers, letters and symbols _ - @ \$ *
 The maximum password length is 12, does not support the character & = \$

How to add account ?

Select one blank column, then enter the new user name, password and privilege, last click Add to take effect. You can see the new added account on the Account list.

User Accounts

Refresh

NO.	Username	Privilege
1	foscarn	Administrator
2	admin	Administrator
3		
4		
5		
6		
7		
8		

Username:

Password:

Password Security Level: Low security level.

Confirm the password:

Privilege:

Change username

Change password

The maximum length of the user name is 20, support numbers, letters and symbols _ - @ \$ *
The maximum password length is 12, does not support the character & = \$

User Accounts

Refresh

NO.	Username	Privilege
1	foscarn	Administrator
2	admin	Administrator
3	user	Administrator
4		
5		
6		
7		
8		

Username:

Privilege:

Change username

Change password

The maximum length of the user name is 20, support numbers, letters and symbols _ - @ \$ *
The maximum password length is 12, does not support the character & = \$

Delete : Select the account which you want to delete, then click Delete button to take effect.

NOTE: The default admin account cannot be deleted, but you can add other administrator users.

How to change the username ?

Firstly, select the account which you want to change the username, then select "Change username", enter the new password, lastly click modify to take effect.

User Accounts

Refresh

NO.	Username	Privilege
1	admin	Administrator
2	operator	Operator
3		
4		
5		
6		
7		
8		

Username:

New username:

Privilege:

Change username

Change password

The maximum length of the user name is 20, support numbers, letters and symbols _ - @\$*

The maximum password length is 12, does not support the character & =

4.3.4 Multi-Camera

If you want to view multi-surveillance screens on one window, you need to login one camera, and set it as the main device, and do Multi-Device Settings, add other cameras to the first one camera. Before you do multi-cams settings, you need to assign different port such as 81, 82, 83, 84, 85, 86, 87, 88 to the cameras if there is 8 cams installed.

The firmware within the camera can support a maximum of 9 devices monitoring all at the same time. This page you can both add FOSCAM MJPEG and H.264 series cameras to the first camera and view multi-surveillance screen on one window.

Add cameras in LAN

In Multi-Device Settings page, you can see all devices searched in LAN. The 1st Device is the default one. You can add more cameras in the list in LAN for monitoring. The camera's software supports up to 9 IP Cameras online simultaneously. Click The 2nd Device and click the item in the Device List in LAN, the Alias, Host and Http Port will be filled in the boxes below automatically. Enter the correct username and password then click Add. Add more cameras in the same way.

Multi-Camera

Cameras On LAN	FI9821P(172.16.0.94) 1111(172.16.1.71) FOSCAM(172.16.0.27) anonymous(172.16.0.179) FOSCAM(172.16.0.105)	<input type="button" value="Refresh"/>
The 1st Camera	This Camera	
The 2nd Camera	None	
Camera Model	<input type="text" value="H264"/>	
Camera Name	<input type="text" value="anonymous"/>	
Host	<input type="text" value="172.16.0.179"/>	
HTTP Port	<input type="text" value="80"/>	
Media Port	<input type="text" value="80"/>	
Username	<input type="text" value="admin"/>	
Password	<input type="password"/>	
	<input type="button" value="Add"/> <input type="button" value="Delete"/>	
The 3rd Camera	None	
The 4th Camera	None	

1 Click it, camera model, alias, host and HTTP Port will be filled in the following boxes automatically.

2 Enter the User name and password of the 2nd camera.

3 Click Add to take effect.

Cameras On LAN	anonymous(192.168.11.193) FI9821W for ebuyer (192.168.11.241) anonymous(192.168.11.203) anonymous(192.168.11.243)	<input type="button" value="Refresh"/>
The 1st Camera	This Camera	
The 2nd Camera	anonymous(192.168.11.203)	
The 3rd Camera	FI9821W for ebuyer (192.168.11.241)	
The 4th Camera	anonymous(192.168.11.203)	
The 5th Camera	None	
The 6th Camera	None	
The 7th Camera	None	
The 8th Camera	None	
The 9th Camera	None	

Note: If you want to access your camera remotely, make sure you are able to access it separately through a browser.

Back to **Surveillance Windows**, and click Four Windows option, you will see four cameras you added.

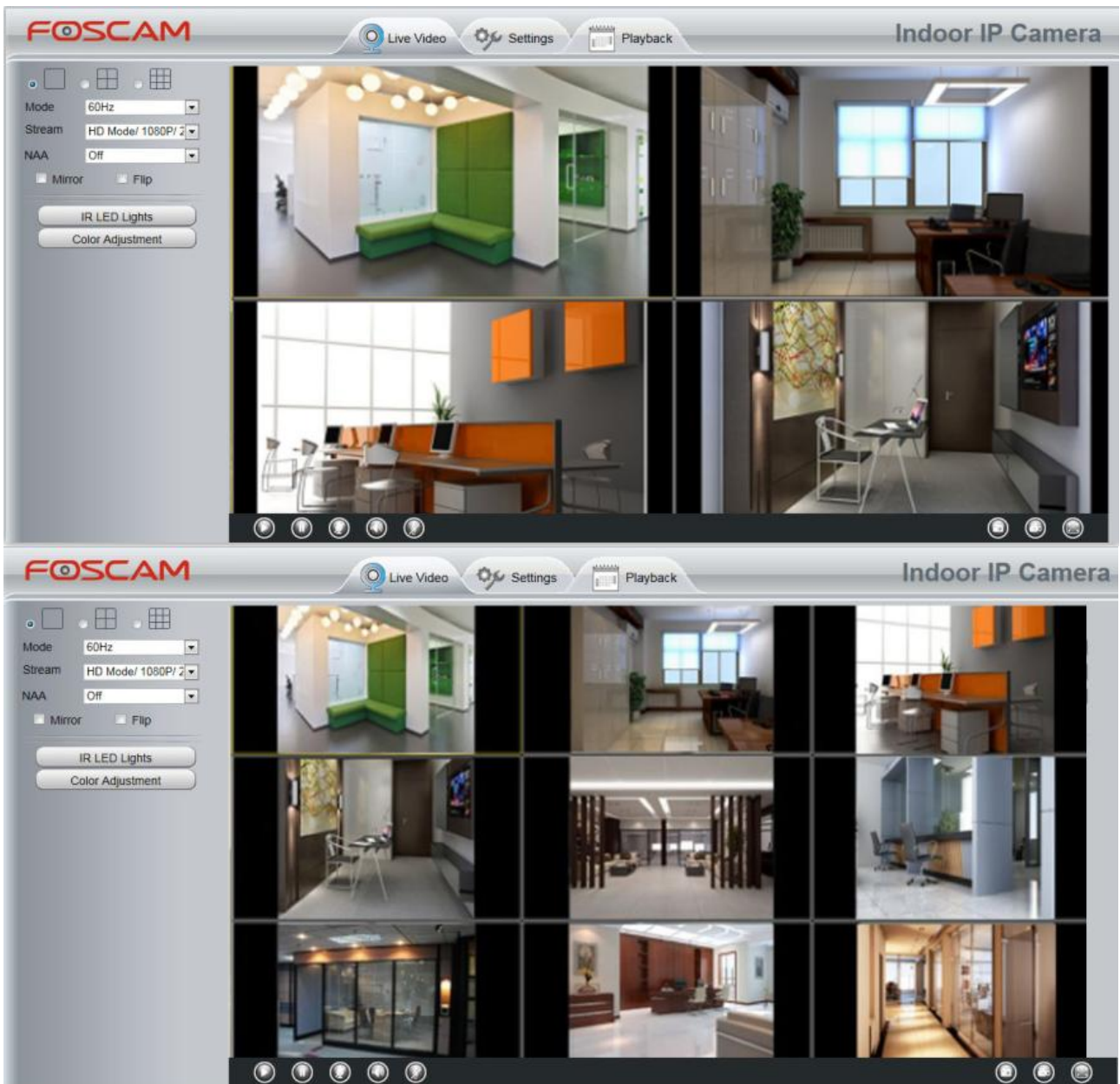

4.3.5 Voice Prompt

On this page, you can enable or disable voice prompt. Select “Yes” to enable or select “No” to disable.

Status Light

Enable Status Light	<div style="border: 1px solid black; padding: 2px;"> Yes </div> <div style="border: 1px solid black; padding: 2px 5px; margin-top: 2px;">No</div>
---------------------	---

4.3.6 Voice Prompt

On this page, you can enable or disable voice prompt. Select “Yes” to enable or select “No” to disable.

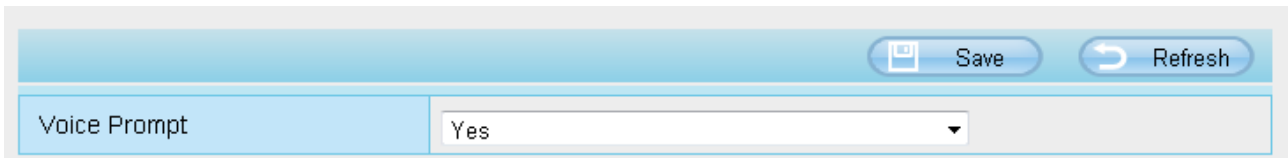

Voice Prompt	Yes
--------------	-----

4.4 Network

This section will allow you to configure your camera's IP, Wireless Settings and Port.

4.4.1 IP Configuration

If you want to set a static IP for the camera, please go to **IP Configuration** page. Keep the camera in the same subnet of your router or computer.



Obtain IP From DHCP

IP Address	192.168.0.109
Subnet Mask	255.255.255.0
Gateway	192.168.0.1
Primary DNS Server	192.168.0.1
Secondary DNS Server	202.96.134.133

Note: Once you save your settings, the camera will restart.

Changing settings here is the same as using the Equipment Search Tool.

It is recommended that you use the subnet mask, gateway and DNS server from your locally attached PC. If you don't know the subnet mask, gateway and DNS server, you can check your computer's local area connection as follows:

Control Panel → **Network Connections** → **Local Area Connections** → **Choose Support** → **Details**

Click the **Scan** button and the camera will detect all wireless networks around the area. It should also display your router in the list.

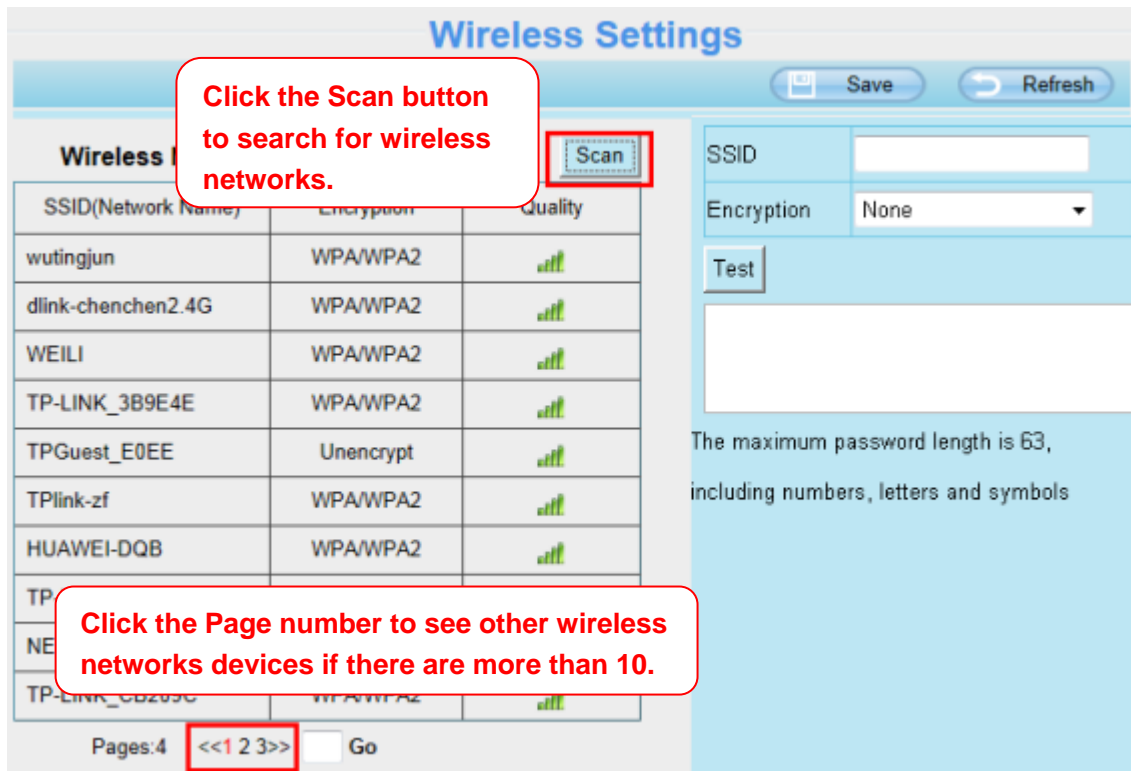

Step 2: Click the SSID (name of your router) in the list, the corresponding information related to your network, such as the name and the encryption, will be filled into the relevant fields automatically.

You will only need to fill in the password of your network. Make sure that the SSID, Encryption and the password you filled in are exactly the same for your router.

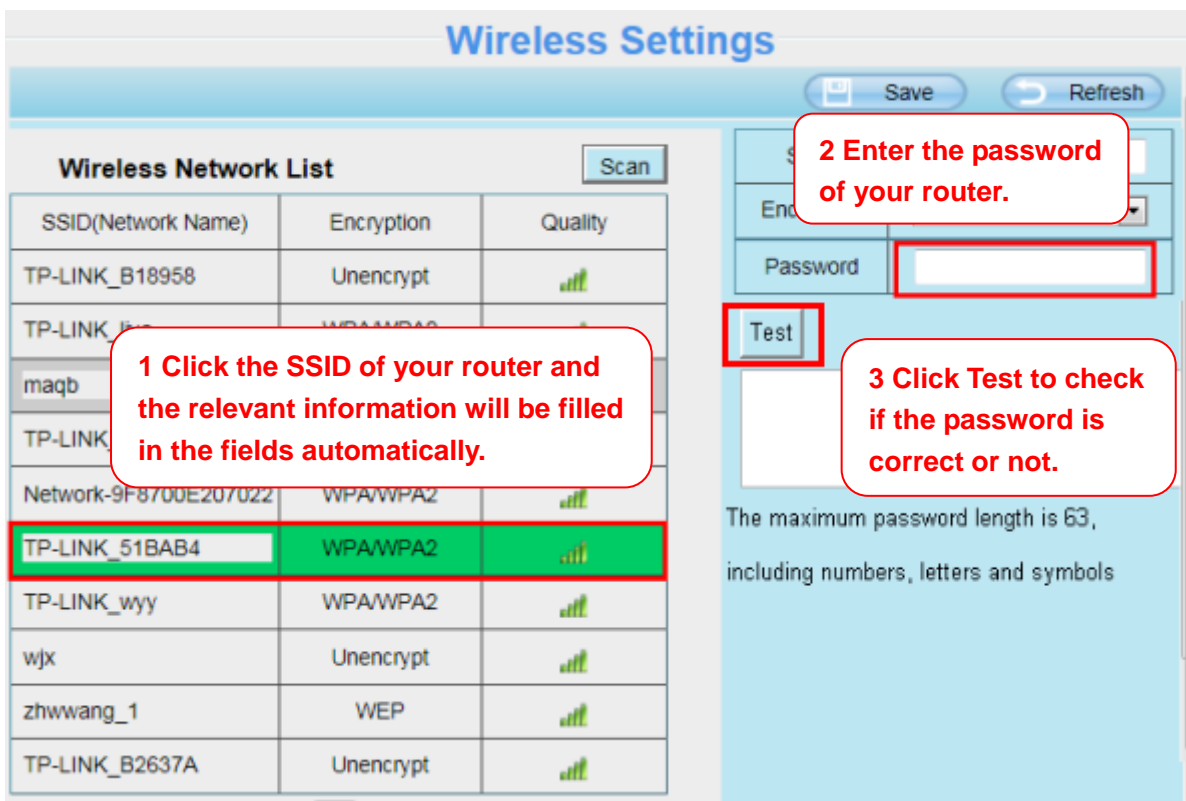

Step 3: Please click on the **Save** button after all settings have been entered and disconnect the network cable. Never shut down the power of the camera until the IP camera is able to connect to the wireless network.

The LAN IP address will disappear on the window of Equipment Search Tool when the camera is configuring a wireless connection. Wait about 1 minute, the camera should obtain a wireless connection, and the LAN IP of the camera will show again on the window of the Equipment Search Tool. The IP address may have changed after the camera receives a wireless connection; we recommend setting a static local IP address if this IP address changes by right clicking the camera in Equipment Search Tool, setting a static IP, and pushing OK.

Congratulations! You have set up the wireless connection of the camera successfully.

NOTE :

If you fail to make a wireless connection, please refer to your seller or contact us directly for assistance.

4.4.3 Port

This camera supports HTTP Port. HTTP Port is used to access the camera remotely. If you want to access the camera and view the video, the HTTP Port must both be configured correctly.

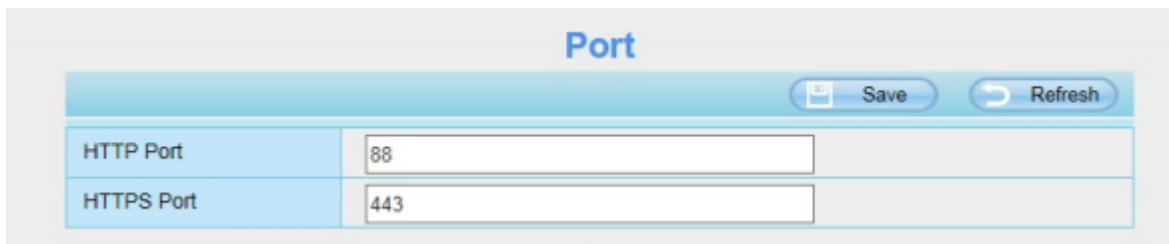

HTTP port: By default, the HTTP is set to 88. Also, they can be assigned with another port number between 1 and 65535. But make sure they can not be conflict with other existing ports like 25, 21.

Another way to change the HTTP port NO.

Step 1: Open the Equipment Search Tool, select the camera you would like to change the port of, right click on the IP address, and click on "Network Configuration", this brings up the network configuration box as flowing figures.

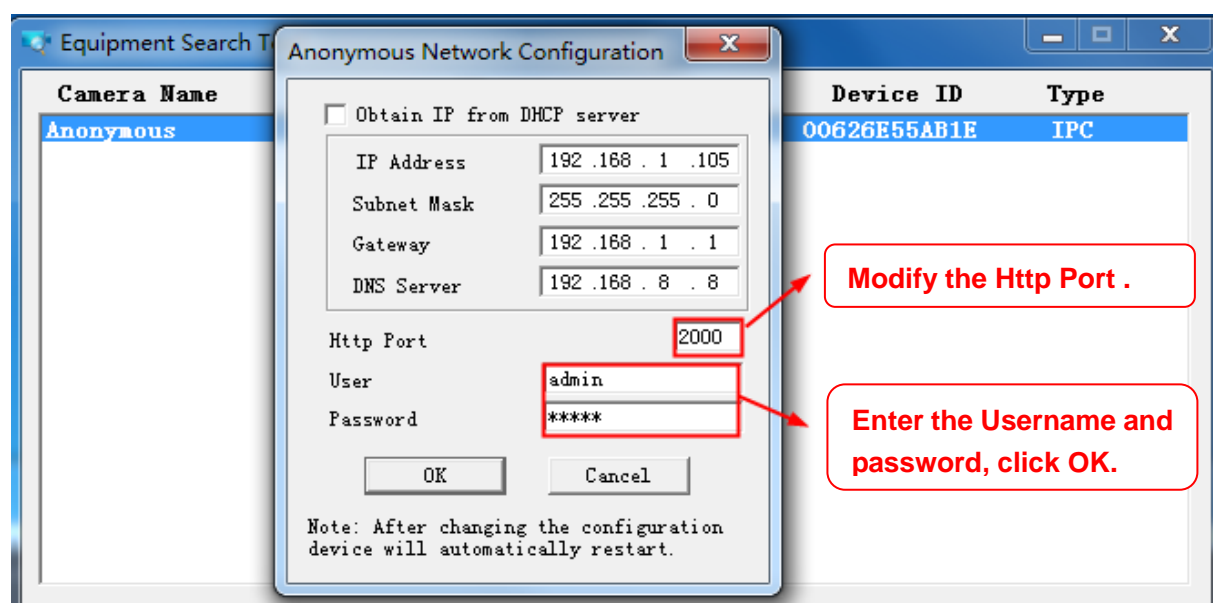
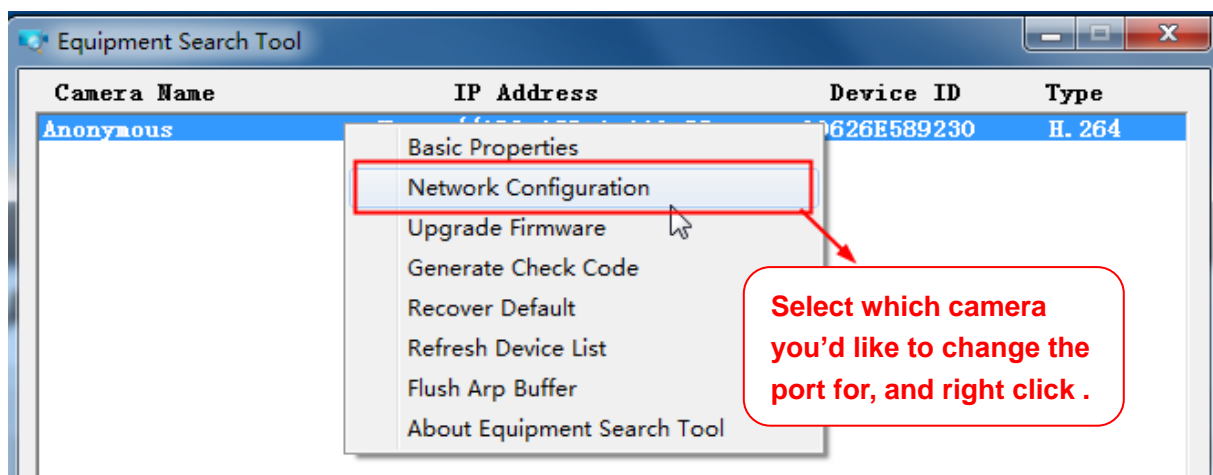

Step 2: Enter the username and password of the Administrator (default username is admin with a blank password), and click “OK” to apply changes.

Step 3: Wait around 10 seconds, you'll see that the camera's LAN IP address has changed. In our example it was changed to 2000, so we see http://192.168.1.110:2000 in Equipment Search Tool. Also, the LAN IP address is now fixed at a static IP address of http://192.168.1.110:2000. This IP address will not change even if the camera is powered off and back on, the camera will remain on this LAN IP address. This is very important that a static LAN IP address is set, or you may have problems later with remote access and seeing the camera remotely if the camera loses power and reconnects on a different LAN IP address. Make sure you set a static LAN IP address!



If the camera cannot be accessed, please make sure the port forwarding is succeed.

HTTPS port: The default port is 443. You can use the url to access the camera: **https:// IP + HTTPS port.**

ONVIF port: By default, the ONVIF port is set to 888. Also, they can be assigned with another port number between 1 and 65535(except 0 and 65534). But make sure they can not be conflict with other existing ports. (C2 only)

RTSP port: The default port is 554.(C2 only)

Note: There are some difference between C1 and C2 on this page, the Onvif port and RTSP port of C1 are showed on Onvif page, you can enable or close the port. Please refer chapter 4.4.10.

4.4.4 Mail Settings

If you want the camera to send emails when motion has been detected, here Mail will need to be configured.

The screenshot shows the 'Mail Settings' configuration page. At the top right, there are 'Save' and 'Refresh' buttons, with a red box and the number '5' highlighting the 'Save' button. Below the buttons, there is an 'Enable' checkbox which is checked. The main configuration area is divided into several sections:

- SMTP Server:** A text input field containing 'smtp.gmail.com'. Below it, a note says 'SMTP server address supports English, numbers and @ _ . -'. A red box and the number '1' highlight this section.
- SMTP Port:** A text input field containing '25'. A red box and the number '1' highlight this field.
- Transport Layer Security:** A dropdown menu set to 'STARTTLS'. Below it, a note says 'G-Mail only supports TLS at Port 465 and STARTTLS at Port 587 or 25. Hotmail only supports STARTTLS at Port 587 or 25.' A red box and the number '1' highlight this section.
- Need Authentication:** A dropdown menu set to 'Yes'. A red box and the number '2' highlight this section.
- SMTP Username:** A text input field containing 'test123@gmai.com'. Below it, a note says 'The maximum length of the user name is 63, support numbers, letters and symbols @ _ . \$ * -'. A red box and the number '2' highlight this section.
- SMTP Password:** A text input field with masked characters '.....'. Below it, a note says 'The maximum password length is 32, does not support the character & ='. A red box and the number '2' highlight this section.
- Sender E-mail:** A text input field containing 'test123@gmai.com'. A red box and the number '3' highlight this field. To the right of this field is a 'Test' button, which is highlighted with a red box and the number '6'.
- First Receiver:** A text input field containing 'test@163.com'. Below it, a note says 'The maximum length of the receiver is 63, support numbers, letters and symbols @ _ . \$ * -'. A red box and the number '4' highlight this section.
- Second Receiver:** A text input field containing 'tset@hotmail.com'. A red box and the number '4' highlight this field.
- Third Receiver:** An empty text input field.
- Fourth Receiver:** An empty text input field.

1---- SMTP Server/ Port /Transport Layer Security Enter SMTP server for sender. **SMTP** port is usually set as 25. Some SMTP servers have their own port, such as 587 or 465, and Transport Layer Security usually is None. If you use Gmail, Transport Layer Security must be set to TLS or STARTTLS

and SMTP Port must be set to 465 or 25 or 587, which port you choose should be decided by which Transport Layer Security you select.

2---- **SMTP Username/ password** ID account and password of the sender email address

3---- **Sender E-mail** Mailbox for sender must support SMTP

4---- **Receiver** Mailbox for receiver need not support SMTP,you can set 4 receivers

5---- **Save** Click Save to take effect

6---- **Test** Click Test to see if Mail has been successfully configured.

Click **Test** to see if Mail has been successfully configured.

The screenshot shows a web-based configuration form for email settings. At the top right, there are 'Save' and 'Refresh' buttons. The form is titled 'Enable' with a checked checkbox. The fields are as follows:

SMTP Server	smtp.gmail.com	SMTP server address supports English, numbers and @ _ . -
SMTP Port	25	
Transport Layer Security	STARTTLS	G-Mail only supports TLS at Port 465 and STARTTLS at Port 587 or 25. Hotmail only supports STARTTLS at Port 587 or 25.
Need Authentication	Yes	
SMTP Username	test123@mai.com	The maximum length of the user name is 63, support numbers, letters and symbols @ _ . \$ * -
SMTP Password	The maximum password length is 32, does not support the character & =
Sender E-mail	test123@mai.com	Test
First Receiver	test@163.com	The maximum length of the receiver is 63, support numbers, letters and symbols @ _ . \$ * -
Second Receiver	tset@hotmail.com	
Third Receiver		
Fourth Receiver		

Below the 'Sender E-mail' field, there is a 'Success' message in a red box and a 'Test result.' message in a red box.

If the test success, you can see the Success behind the Test, at the same time the receivers will receive a test mail.

If the test fails with one of the following errors after clicking **Test**, verify that the information you entered is correct and again select Test .

- 1) Cannot connect to the server
- 2) Network Error. Please try later
- 3) Server Error
- 4) Incorrect user or password
- 5) The sender is denied by the server. Maybe the server need to authenticate the user, please check it and try again

- 6) The receiver is denied by the server. Maybe because of the anti-spam privacy of the server
- 7) The message is denied by the server. Maybe because of the anti-spam privacy of the server
- 8) The server does not support the authentication mode used by the device

4.4.5 FTP Settings

If you want to upload record files and images to your FTP server, you can set **FTP Settings**.

FTP Server	ftp://192.168.8.150 Example:ftp://192.168.1.103/dir The maximum length of the address is 127, does not support the character & =
Port	21
FTP Mode	PORT
Username	yaocuixiang The maximum length of the user name is 63, support numbers, letters and symbols _ @ \$ * - , . # !
Password The maximum password length is 63, does not support the character & =
<input type="button" value="Test"/>	Success

Figure a

FTP server	ftp://ftp.mgenseal.com example:ftp://192.168.1.103
Port	21
FTP Mode	PORT
User name	deotestge
Password
<input type="button" value="Test"/>	Success

Figure b

FTP server: If your FTP server is located on the LAN, you can set as Figure a.

If you have an FTP server which you can access on the internet, you can set as Figure b.

Port: Default is port 21. If changed, external FTP client program must change the server connection port accordingly.

FTP Mode: Here supports two modes: PORT and PASV.

Username/password: The FTP account and password.

Click **Save** to take effect.

Click **Test** to see if FTP has been successfully configured.

4.4.6 P2P

Access the IP Camera by Smart Phone (Android or iOS operating system)

First of all, you must open the P2P function of the IP Camera at “Settings --> Network --> P2P.”



Foscam App named **Foscam** on App Store and Google Play for iOS and Android devices.

NOTE:

If the QR code scanning is not successful, please input the UID on the bottom of the camera manually.

4.4.7 Onvif

On this page, you can enable the Onvif port and RTSP port. ONVIF(Open Network Video Interface Forum) is a standard for talking to Network Camera Devices and other similar security hardware.

ONVIF port: By default, the ONVIF port is set to 888. Also, they can be assigned with another port number between 1 and 65535(except 0 and 65534). But make sure they can not be conflict with other existing ports.

RTSP port: The default port is 554.



4.5 Video

This section allows you to configure Video stream settings, On screen display and Snapshot settings.

4.5.1 Video Settings

There are two ways to set the stream video settings. They are main stream video settings and sub

stream video settings.

Video Settings

Save Refresh

Main stream video settings

Stream Type	HD Mode
Resolution	1080P
Bit Rate	4M
Frame Rate	
Key Frame Interval	30
Rate Control Mode	VBR

Sub stream video settings

Stream Type	HD Mode
Resolution	VGA(640*480)
Bit Rate	512K
Frame Rate	20
Key Frame Interval	15
Rate Control Mode	CBR

Stream Type: There are four types to identify different streams you have set. If select the HD Mode, the clearer video will become, and it will take up more bandwidth; If select the Smooth Mode, the bandwidth is very narrow, and bit rate is large, that will lead to video can not play well. The Equilibrium Model is a value between HD Mode and Smooth Mode.

Resolution: The camera supports multiple types, For example: 960P, 720P, VGA. The higher the resolution is the clearer video will become. But the code flux will become larger too, and it will take up more bandwidth. (The maximum frame rate for each model is different, please see the “Specifications” .)

Bit Rate: Generally speaking, the larger the bit rate is, the clearer video will become. But the bit rate configuration should combine well with the network bandwidth. When the bandwidth is very narrow, and bit rate is large, that will lead to video can not play well.

Frame rate: You should lower frame rate when the bandwidth is limited. Normally, when the frame rate above 15, you can achieve fluently video.

Key Frame Interval: The time between last key frame and next key frame. The shorter the duration, the more likely you will get a better video quality, but at the cost of higher network bandwidth consumption.

Variable bitrate: Select the Bit rate type to constant or variable. If select Yes, the camera will change the video bit rate according to the situation, but will not more than the maximum parameter "Bit Rate"; If

select No, the Bit Rate is unchanged.

4.5.2 On Screen Display

This page is used to add timestamp and device name on the video.

OSD	
Save Refresh	
Display Timestamp	Yes
Display Camera Name	Yes

Display Timestamp

There are two options: Yes or NO. Select Yes and you can see the system date on the video.

Display Camera Name

There are two options: Yes or NO. Select Yes and you can see the device name on the video.

4.5.3 Snapshot Settings

On this page you can set the snapshot pictures' image quality and the storage path.

Snapshot Settings	
Save Refresh	
Manual snap Quality	Medium
Pictures Save To	FTP
Enable timing to capture <input checked="" type="checkbox"/>	
Capture interval	2 (1-65535s)
Enable set Filename <input checked="" type="checkbox"/>	
Filename	
Schedule	
All	00 01 02 03 04 05 06 07 08 09 10 11 12 13 14 15 16 17 18 19 20 21 22 23
MON	
TUE	
WED	
THU	
FRI	
SAT	
SUN	

Manual snap Quality: Low, Middle and High. The higher the quality, the picture will be clearer.

Pictures Save To: FTP or SD card. If you have done FTP and Alarm settings, when alarming, the

camera will snap pictures to the FTP or SD card automatically.
If you select the FTP, you can set the file name which the picture save to (Only C1).

Enable timing to capture

To enable capture interval, follow the steps below:

1 Select **Enable Motion detection**

2 **Capture interval:**The interval time between two captures.

3 Select the capture time

- Capture anytime

Click the black button up the MON, you will see all time range turn red. When something moving in the detection area at anytime, the camera will capture.

- Specify an capture schedule

Click the week day words, the corresponding column will be selected. For example, click TUE, the all column of TUE turns to red, that means during Tuesday whole day, the camera will capture.

- Press the left mouse and drag it on the time boxes, you can select the serial area,

4 Click **Save button** to take effect.

4.5.4 IR LED Schedule

On this page you can set the schedule time for switching IR LED lights. When parameter Mode is set to the **Schedule** on the **Live Video** window, at these schedule time, the IR LED lights will be turned off.

IR LED Schedule

Save Refresh

IR LED Schedule

Turn the IR LED off

From 08 :00 To 18 :00

Add

4.6 Detector

4.6.1 Motion Detection

IP Camera supports **Motion Detection Alarm**, when the motion has been detected, the IP Camera will make a alarm.

Step 1: Enable motion detection function.

Step 2: Sensitivity---- It supports five modes: Lowest, Lower, Low, Medium and High. The higher the sensitivity, the camera will be more easily alarmed. Select one motion sensitivity.

Step 3: Trigger interval--- The interval time between two motion detection.

Step 4: There are some alarm indicators:

A Camera Sound and PC Sound

If the camera has connected with a speaker or other audio output device, if you select Camera Sound or PC Sound, when the motion has been detected, the people around the camera will hear beep alarm sound.

B Send E-mail

If you want to receive alarm emails when motion is detected, you must select Send E-mail and set Mail Settings first.

C Take Snapshot

If you select this checkbox, when the motion has been detected, the camera will snap the live view window as a still picture and load it to the FTP. Make sure you have set FTP and set FTP as the storage path in Video->Snapshot settings panel.

Time interval: The interval time between two pictures.

D Recording

If you select this checkbox, when the motion has been detected, the camera will record automatically and store the record files to the SD Card. Make sure the camera has inserted SD card and you have set the SD card as the Alarm record files storage path, please go to **Record**—> **Storage location** page to verify this settings.

The default alarm record time is 30s and pre-alarm record time is 5s, please go to **Record**—> **Alarm Record** page and change the alarm time settings.

E Push message to the phone

If you select this checkbox, when the motion has been detected, the camera will push the message to the phone which has been connected the camera.

Step 5: Set detection area

Click set detect area and it pop up a window, then you can draw the detection area. Click **Back** button after settings. When something moving in the detection area, the camera will alarm.

Step 6: Alarm Schedule

① Alarm anytime when motion is detected

Click the black button up the MON, you will see all time range turn red. When something moving in the detection area at anytime, the camera will alarm.

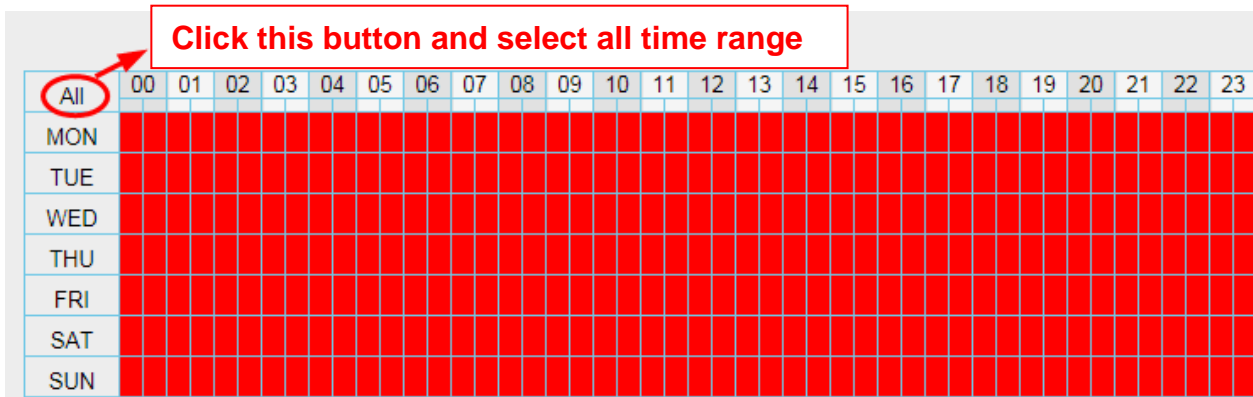

Click this button and select all time range

	00	01	02	03	04	05	06	07	08	09	10	11	12	13	14	15	16	17	18	19	20	21	22	23
All																								
MON																								
TUE																								
WED																								
THU																								
FRI																								
SAT																								
SUN																								

② Specify an alarm schedule

Click the week day words, the corresponding column will be selected. For example, click TUE, the all column of TUE turns to red, that means during Tuesday whole day, when something moving in the detection area, the camera will alarm.

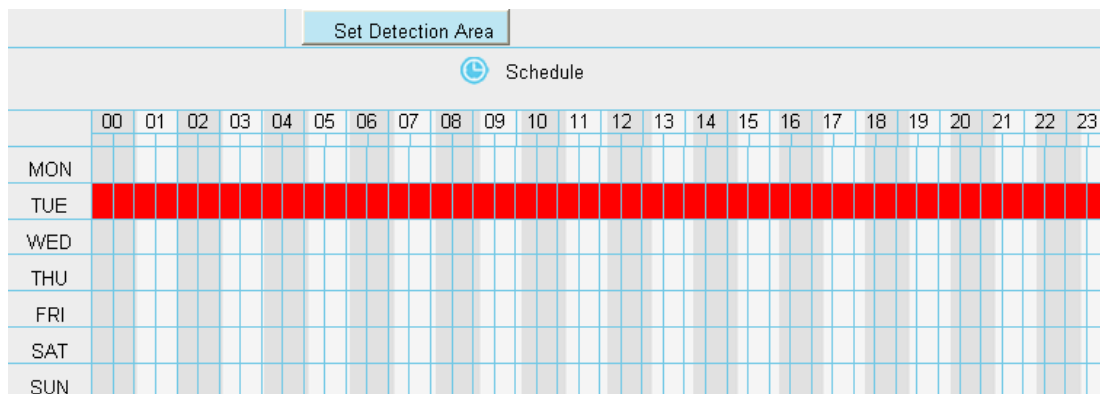

	00	01	02	03	04	05	06	07	08	09	10	11	12	13	14	15	16	17	18	19	20	21	22	23
MON																								
TUE																								
WED																								
THU																								
FRI																								
SAT																								
SUN																								

③ Press the left mouse and drag it on the time boxes, you can select the serial area.

		Set Detection Area																							
		Schedule																							
		00	01	02	03	04	05	06	07	08	09	10	11	12	13	14	15	16	17	18	19	20	21	22	23
MON																									
TUE																									
WED																									
THU																									
FRI																									
SAT																									
SUN																									

Step 7: Click Save button to take effect.

When the motion has been detected during the detection time in the detection area, the camera will alarm and adopt the corresponding alarm indicators.

NOTE: You must set the detection area and detection schedule, or else there is no alarm anywhere and anytime.

4.6.2 Sound alarm

The C1 does not support this feature.

When the ambient sound over a certain decibel ,the sound alarm will be triggered.

Sound Detection

Enable

Sensitivity	Low	
Triggered Interval	15s	
Action	Camera Sound <input type="checkbox"/> PC Sound <input type="checkbox"/>	
	Send E-mail <input checked="" type="checkbox"/>	
	Take Snapshot <input checked="" type="checkbox"/> Time Interval <input type="text" value="2s"/>	
	Please set the capture storage location in advance.(Video -> Snapshot Settings)	
	Recording <input checked="" type="checkbox"/>	
Please set the video storage location in advance.(Record -> Storage Location)		
Push message to the phone <input checked="" type="checkbox"/>		

	00	01	02	03	04	05	06	07	08	09	10	11	12	13	14	15	16	17	18	19	20	21	22	23
All																								
MON																								
TUE																								

If the Sensitivity is set to “High”, the camera will detect the sound whose more than 55db.
 If the Sensitivity is set to “Medium”, the camera will detect the sound whose more than 65db.
 If the Sensitivity is set to “Low”, the camera will detect the sound whose more than 75db.
 If the Sensitivity is set to “Lower”, the camera will detect the sound whose more than 85db.
 If the Sensitivity is set to “Lowest”, the camera will detect the sound whose more than 95db.

4.7 Record

This section will allow you to change the record files storage path and the record time.

4.7.1 Storage Location

On this page you can change the alarm and manually recording storage path.

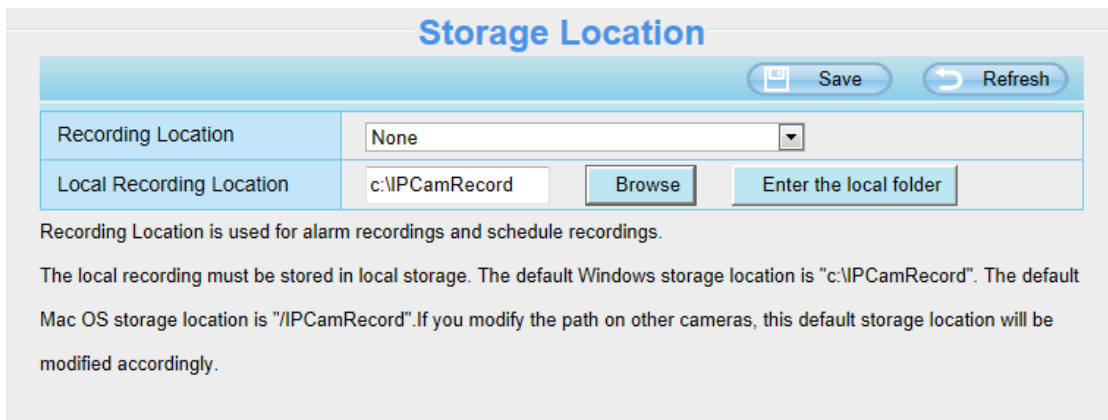

Recording Location : SD card or FTP. **Make sure the SD card has been inserted into the camera.**
 On this page, you can see the available space of the SD card.

Local Recording Location: For Windows OS, the manual recording path is C:/ IPCamRecord, you can change another one. For MAC OS, the manual recording path is: / IPCamRecord.

Enter the local folder: Click here, You can enter the local storage folder.

4.7.2 Alarm Recording

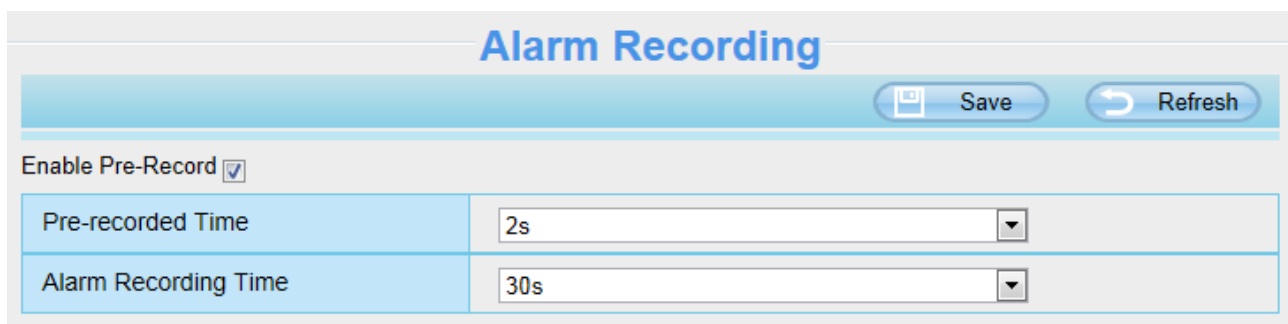

4.7.3 Local Alarm Recording

This page you can enable the local alarm record and Local Alarm record time.

The screenshot shows the 'Local Alarm Recording' configuration page. At the top, there is a title 'Local Alarm Recording' and two buttons: 'Save' and 'Refresh'. Below the title, there is a checkbox labeled 'Enable Local Alarm Recording' which is checked. Underneath, there is a label 'Local Alarm Recording Time' followed by a text input field containing '30s' and a dropdown arrow.

4.7.4 Schedule Recording

When the video is selected as FTP, the device supports scheduled recording.

When the parameter **Recording Location** is set **SD Card** on the **Storage Location** page, you can configure parameters as shown in follow figure.

The screenshot shows the 'Storage Location' configuration page. On the left is a sidebar menu with options: Setup Wizard, Status, Basic Settings, Network, Video, Detector, Record, Storage Location (highlighted with a red box), Alarm Recording, and Local Alarm Recording. The main content area has a title 'Storage Location' and 'Save' and 'Refresh' buttons. Below the title, there are two rows: 'Recording Location' with a dropdown menu set to 'FTP' (highlighted with a red box), and 'Local Recording Location' with a text input field containing 'c:\IPCamRecord', a 'Browse' button, and an 'Enter the local folder' button. Below these fields, there is explanatory text: 'Recording Location is used for alarm recordings and schedule recordings. The local recording must be stored in local storage. The default Windows storage location is "c:\IPCamRecord". The default Mac OS storage location is "/IPCamRecord". If you modify the path on other cameras, this default storage location will be modified accordingly.'

Scheduled Recording To FTP

Enable Scheduled Recording:

Stream: Main stream

All	00	01	02	03	04	05	06	07	08	09	10	11	12	13	14	15	16	17	18	19	20	21	22	23
MON																								
TUE																								
WED																								
THU																								
FRI																								
SAT																								
SUN																								

Scheduled recording only supports SD card or FTP server.

Scheduled recording will stop while alarm recording begins, and go on automatically after it ends.

When the video is selected as SD card, the device supports pumping frame recording.

When the parameter **Recording Location** is set **SD Card** on the **Storage Location** page, you can configure parameters as shown in follow figure.

- Setup Wizard
- Status
- Basic Settings
- Network
- Video
- Detector
- Record
- Storage Location
- Alarm Recording
- Local Alarm Recording
- Scheduled Recording

Storage Location

Recording Location	SD card	788.3 MB / 7.4 GB
Local Recording Location	<input type="text" value="c:\IPCamRecord"/>	<input type="button" value="Browse"/> <input type="button" value="Enter the local folder"/>

Recording Location is used for alarm recordings and schedule recordings.

The local recording must be stored in local storage. The default Windows storage location is "c:\IPCamRecord". The default Mac OS storage location is "/IPCamRecord". If you modify the path on other cameras, this default storage location will be modified accordingly.

Scheduled Recording To SD Card

Enable Scheduled Recording

Record full strategy	Cover
Audio Record	No
Stream	Main stream

[Edit Scheduled Recording](#)

All	00	01	02	03	04	05	06	07	08	09	10	11	12	13	14	15	16	17	18	19	20	21	22	23
MON																								
TUE																								
WED																								
THU																								
FRI																								
SAT																								
SUN																								

Scheduled recording only supports SD card or FTP server.

Record full strategy: When the SD card is full, you can choose to cover the previous recording, or stop recording.

Audio Record: You can choose "yes" or "no".

NOTES:

- Scheduled recording only supports video saved to the SD card or FTP server.
- The schedule recording will stop while alarm recording is beginning, and it will continue automatically after alarm recording end.
- You can refer to "alarm schedule." in "Alarm" about editing the time of recording Schedule.

4.7.5 SD Card Management

This camera supports Mirco SD Card. When you plug in the Mirco SD card during the camera work process, please reboot the camera again, or else the Mirco SD Card may be cannot work well.

Note: Foscam IP camera only supports EX-FAT and FAT-32 forma

SD Card Management

SD Card Status	SD card	SD Card Management
SD Card Free Space	1.1GB	
SD Card Total Space	7.4GB	

Note: SD card management is only effective when access the IPC in LAN

The default storage path of alarm record files is SD card, when the available size of SD card is less than 256M, the old record files will be deleted automatically.

SD Card Management: After click the button, you should enter the username and password of the camera. Then you can manage the recording files of the camera in the SD card. The SD card management is only effective when access the camera in LAN.

4.8 Firewall

This section explains how to control the access permission by checking the client PC's IP addresses. It is composed of the following columns: **Block access from these IP addresses** and **Only allow access from these IP addresses**.

Enable Firewall

IP Filtering	<div style="border: 1px solid #ccc; padding: 2px;"> Block access from these IP addresses ▼ <ul style="list-style-type: none"> <li style="background-color: #e0e0e0; padding: 2px;">Block access from these IP addresses <li style="padding: 2px;">Only allow access from these IP addresses </div>
IP Address #1	<input type="text"/>
IP Address #2	<input type="text"/>
IP Address #3	<input type="text"/>
IP Address #4	<input type="text"/>
IP Address #5	<input type="text"/>
IP Address #6	<input type="text"/>
IP Address #7	<input type="text"/>
IP Address #8	<input type="text"/>

Enable firewall, If you select Only allow access from these IP addresses and fill in 8 IP addresses at most, only those clients whose IP addresses listed in the **Only allow access from these IP addresses** can access the Network Camera. If you select **Block access from these IP addresses**, only those

clients whose IP addresses are in the IP list cannot access the Network Camera.
Click **Save** to take effect.

4.9 System

In this panel, you can backup/restore your camera settings, upgrade the firmware to the latest version, restore the camera to default settings and reboot the device.

4.9.1 Back-up& Restore

Click **Backup** to save all the parameters you have set. These parameters will be stored in a bin file for future use.

Click Browse and select the parameters file you have stored, then click Submit to restore the restore the parameters.

Backup is used to save your current settings. It is recommended to backup your configuration before modifying or upgrading firmware.

Settings can be restored by uploading the backup file.

Path:

Note:

1. All current settings will be lost when importing a configuration file. If an incorrect file is loaded, the camera may stop working correctly.
2. Keep the power on during this process, or you may damage your camera. Your camera will reboot automatically once restoration is completed.

4.9.2 System Upgrade

Click "Download the latest firmware", you will see the following screen. And click "save" to save the firmware on your computer locally.

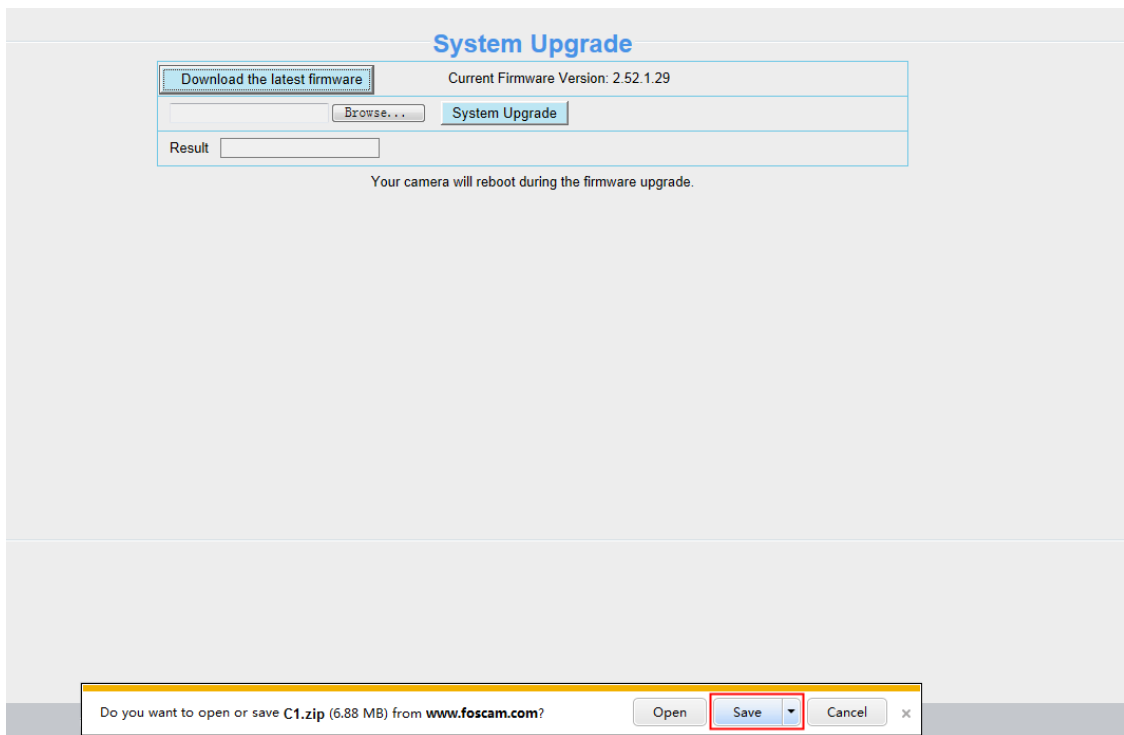

Your current firmware version will be displayed on your screen. You may go to the **Status→ Device Information** page to check for the latest firmware versions available. Click **Browse**, choose the correct bin file and then click **System upgrade**. Don't shut down the power during upgrade. After upgrading, you can see the upgrade result.

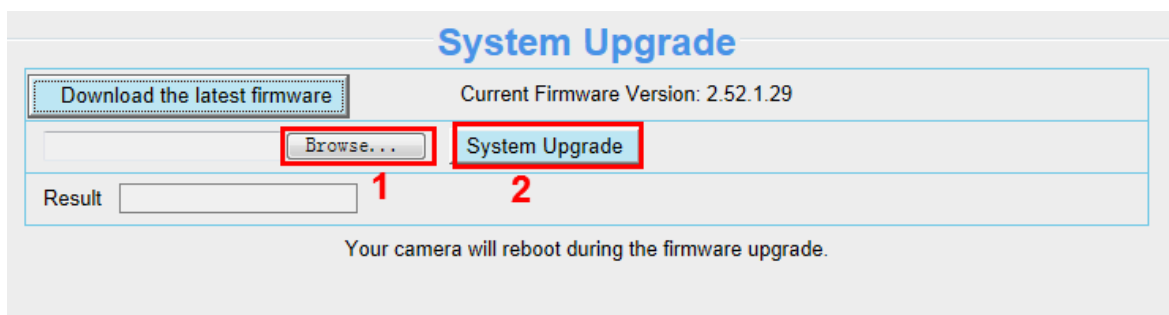

Upgrade Firmware by Equipment Search Tool

Double click the Equipment Search Tool shot icon  , select the Camera IP that you want to upgrade the firmware. Then select Upgrade Firmware and enter the username and password, choose the firmware file, and upgrade.

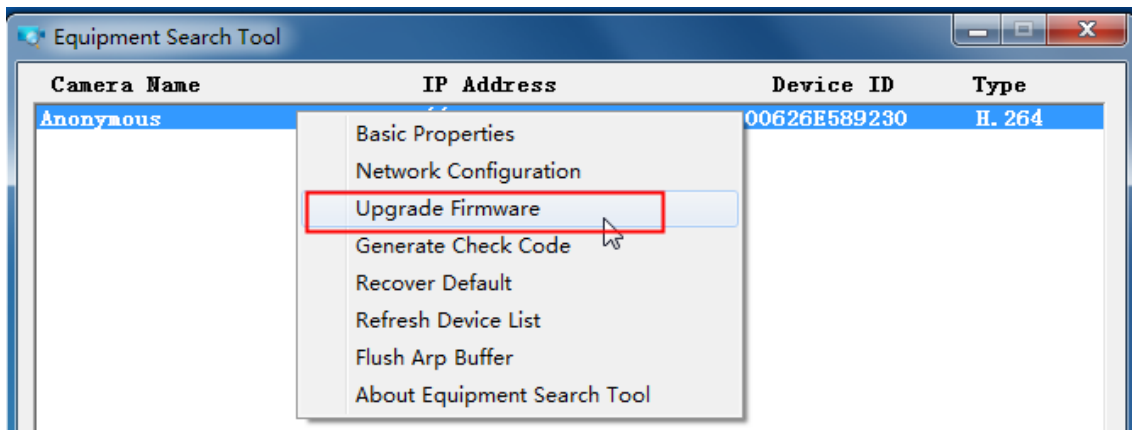
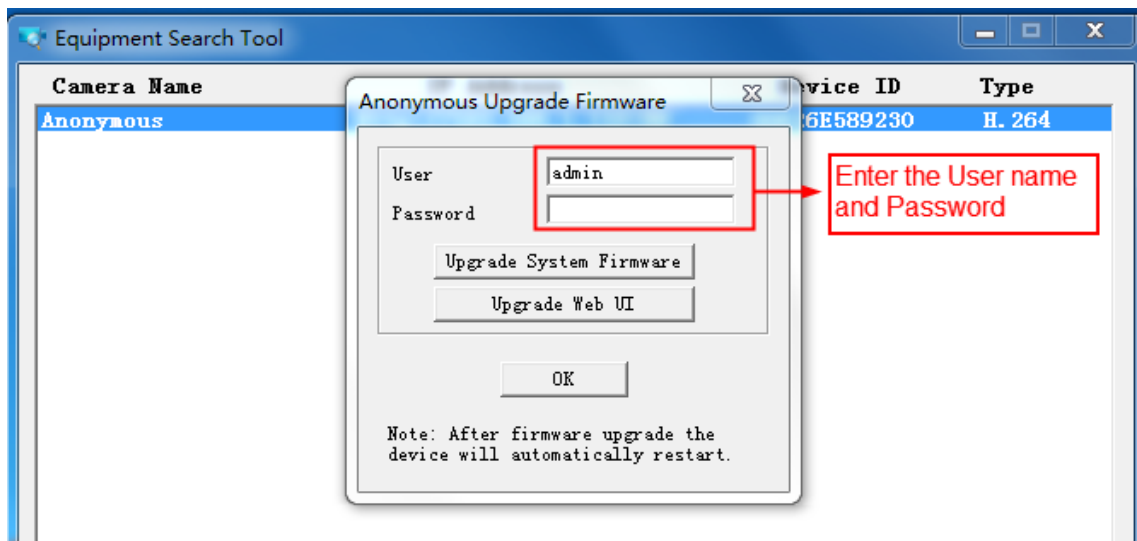

Figure 4.1



CAUTION: We recommend that you regularly update your camera to the latest available software and firmware versions to help ensure the best experience for your camera.

NOTES:

- Read the upgrade documentation (readme.txt file) in the upgrade package before you upgrade.
- Upon downloading the firmware check the sizes of the .bin files. They must match the size in the readme.txt file. If not, please download the firmware again until the sizes are the same. Your camera will not function correctly if a corrupt .bin file is used.
- Never shut down the power of the camera during upgrade until the IP camera restart and get connected.
- After upgrade successfully, please uninstall the old plugin and re-install it, then reset the camera to the default factory settings before using the camera.

4.9.3 Patch Installation

Click "Browse" to select the correct patch file, and then click "Install Patch" to install the patch. Do not turn off the power during it installing. After installing is complete, you will receive a system prompt.

Patch Installation

<input type="text"/>	<input type="button" value="Browse..."/>	<input type="button" value="Install Patch"/>
<input type="button" value="Uninstall Patch"/>		
Result	<input type="text"/>	

Your camera will reboot when you install/uninstall patch.

4.9.4 Factory Reset

Click All reset and all parameters will return to factory settings if selected. This is similar to press the Reset button on the bottom of the camera.

Factory Reset

<input type="button" value="Factory Reset"/>	Click this button to reset the camera to factory default.
--	---

4.9.5 Reboot

Click Reboot System to reboot the camera. This is similar to unplugging the power to the camera.

Reboot

<input type="button" value="Reboot"/>	Click this button to reboot your camera.
---------------------------------------	--

5 Playback

On this page you can view the record files stored in the SD card.

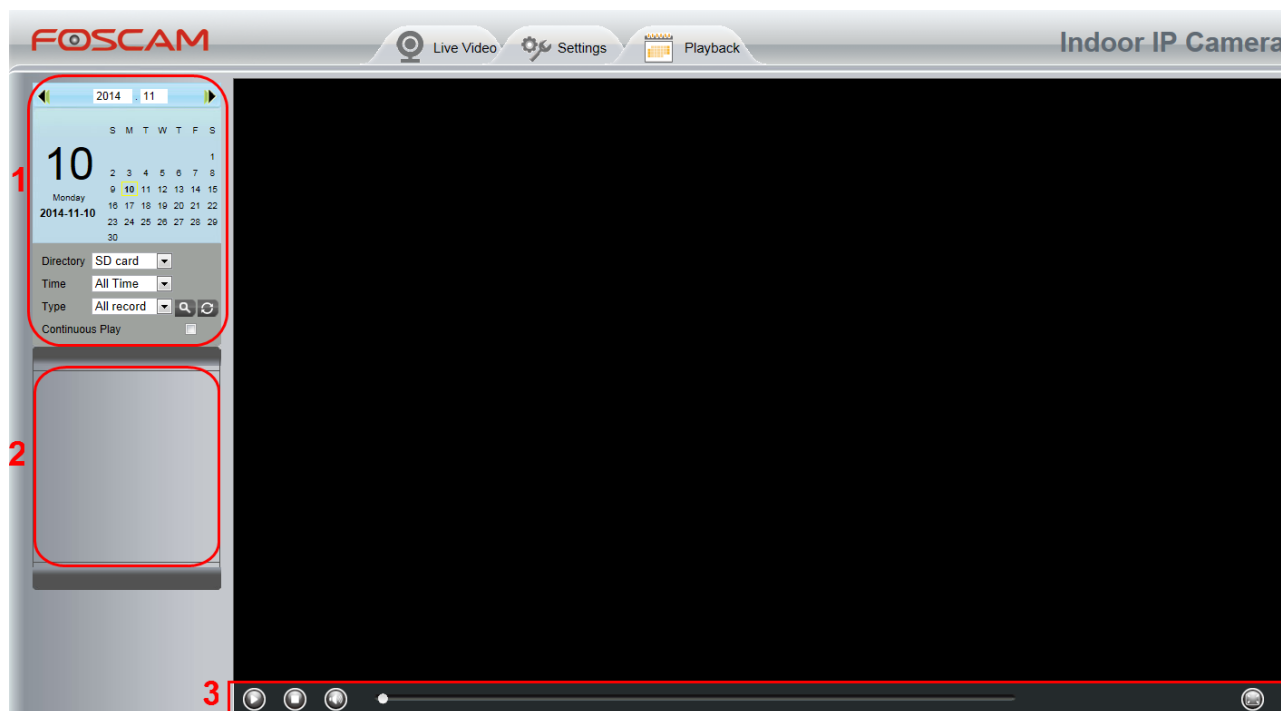

Section 1 Define the Record files time and Type

Directory : The storage path of record files

Time : Here supports three types: current day, current month and All records. Another way, select the time on the time&date manually.



Type : The type of records files, Here supports two types: Normal record, Alarm record and All records.

 : Click this button to search all record files satisfy the conditions you selected.

Continuous Play: Select the checkbox to play continuously all the record files.

Section 2 Search record files

On this panel you can see all record files satisfy the conditions you set.

Section 3 Play/Stop/Audio/Full screen buttons

Please select one record file before use these buttons.



Click this button to play the record files



Click this button to stop the record files



Open or stop audio



Click this button to make full screen, and double click left mouse to exit full screen.

6 Appendix

6.1 Frequently Asked Questions

NOTE: Any questions you would meet, please check Network connections firstly. Check the working status revealed by the indicators on the network server, hub, and exchange. If abnormal, check the network connections.

6.1.1 Equipment search tool cannot find the camera

After power on camera and connect it to router by Ethernet cable, open Equipment Search Tool it cannot find any camera IP address. Shows a blank window like below.

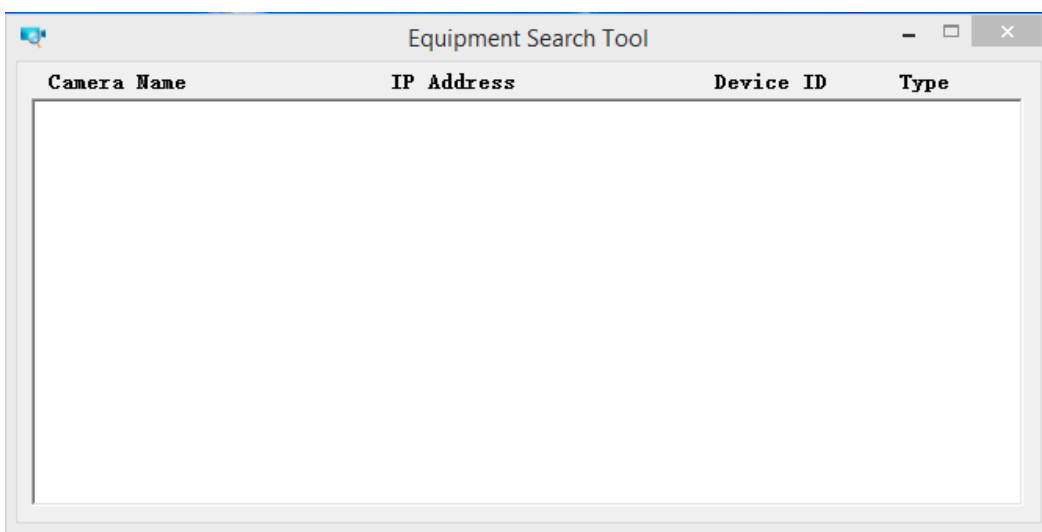

This is usually because camera doesn't get an IP in same network segment as the computer. Please follow below steps to fix the problem.

1. Make sure both camera and computer are connected to same router.
2. Make sure camera's connected to router properly and camera status is normal.
For indoor pan/tilt cameras, when powered on you will see a red power light and camera will pan/tilt. And on LAN port you'll see a blinking orange light and a solid green light.
3. Reset camera to have a check. Just keep pressing rest button on camera with power on for about 30 seconds till it reboot. Reset button is usually on back/bottom of camera, or on the end cords.
4. Try another Ethernet cable or hook into another LAN port on router.
5. Make sure the router DHCP server is enabled and there is no Mac address filter.
Check router's DHCP list as well, to see if you can find camera's IP address there.
If yes, please try to log-in the camera directly by manually input the IP address and port (default http port: for SD camera is 80, for HD camera is 88) of camera into address bar of web browser.
6. Please turn off any virtual machine or multiple connection (use only wired or wireless connection) that is running on computer.
7. At latest make sure there's no firewall is blocking Equipment Search Tool or other search tool conflicts with it.

6.1.2 Install plugin for Internet Explore

Suggest use IE browser to log in the camera and install the plugin for the first time, then you can use it on other browser as well. Just remember to allow the plugin to run. See below for steps to install plugin via IE browser.

Step 1: User IE browser to log in the camera for the first time, it will prompt to ask your install the plugin on the bottom of IE browser.

Step 2: Click **Install** to continue the installation of the .exe plugin.

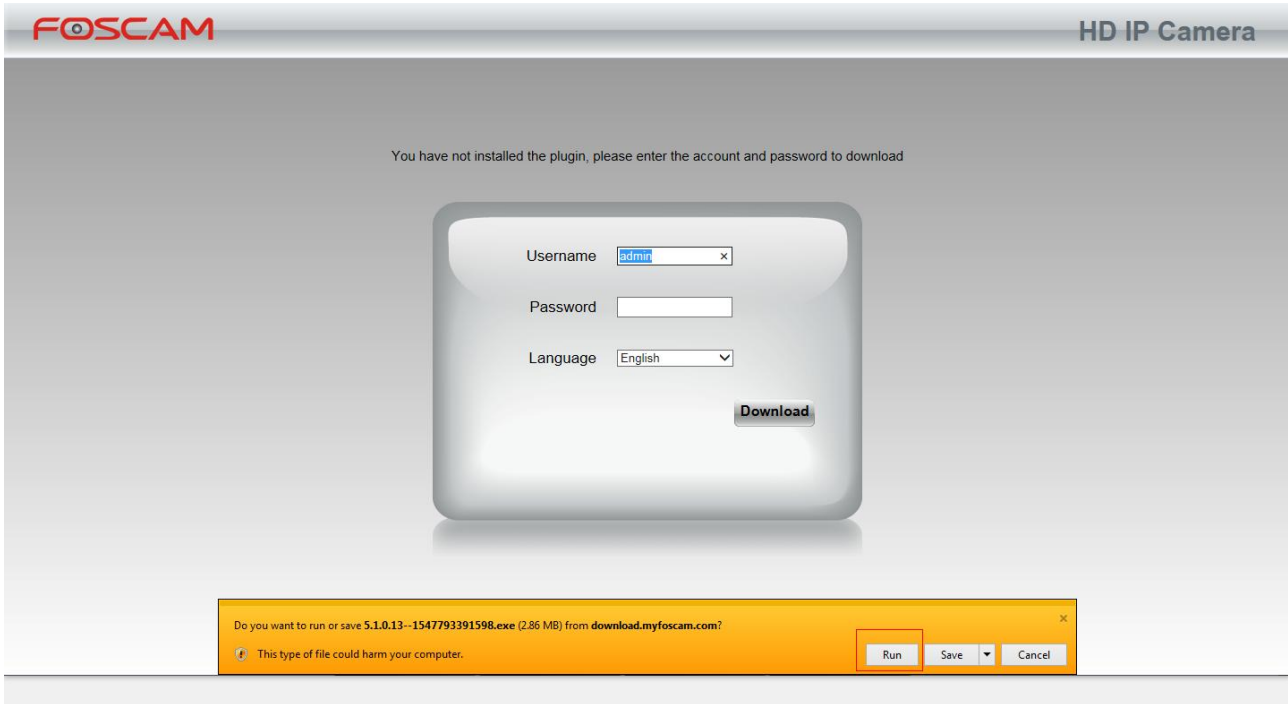

Step 3: Follow the Setup Wizard to finished installing the plugin

Note: When starting to install the plug-in, it will force to close the IE browser. Please click **Yes** to close the IE browser firstly.

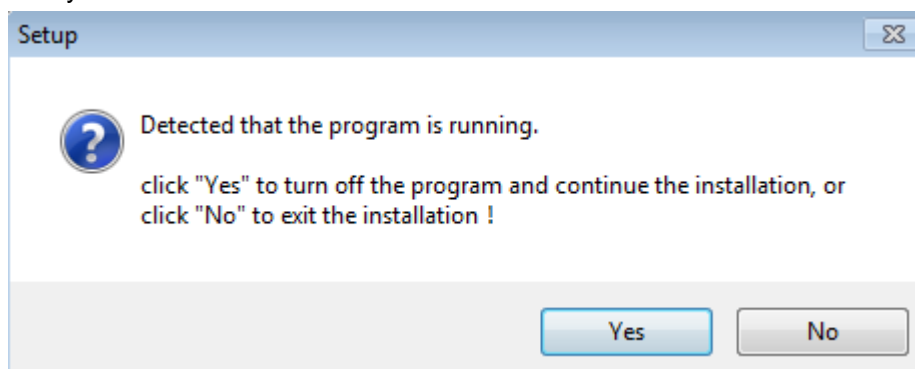

And click **Next** to follow the setup wizard.

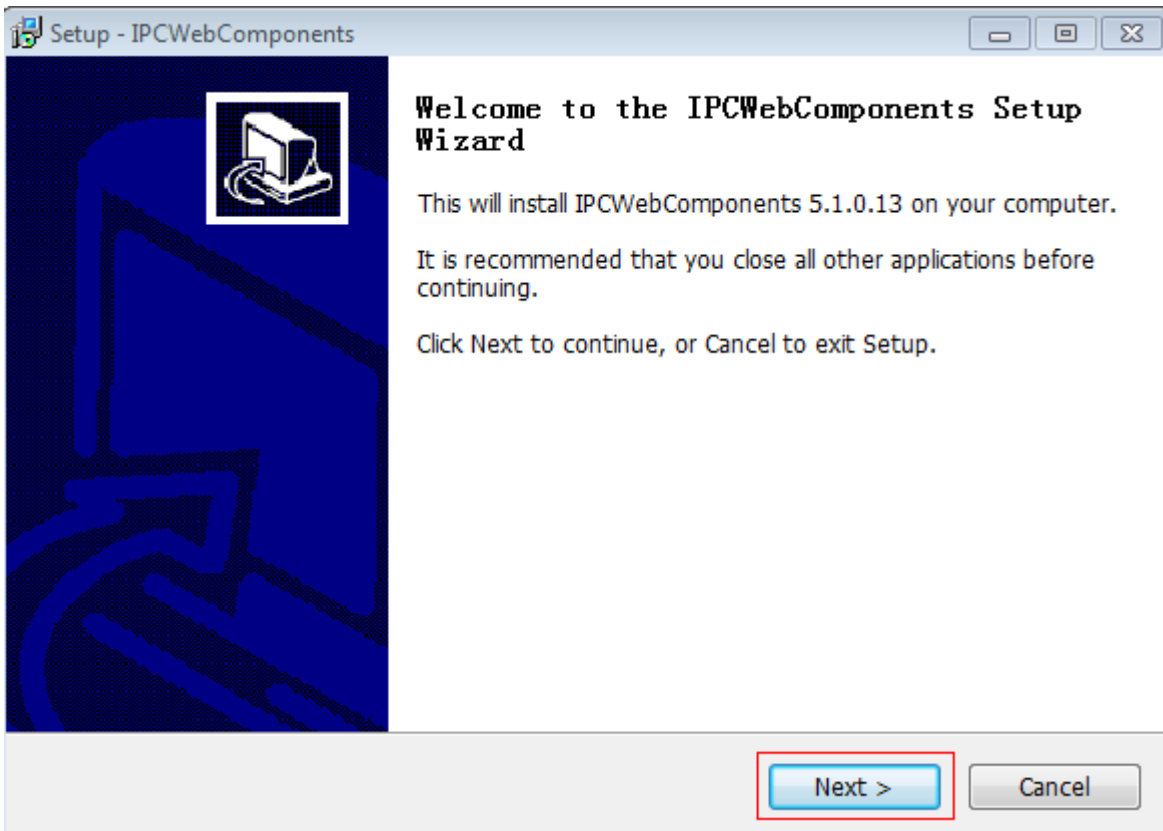
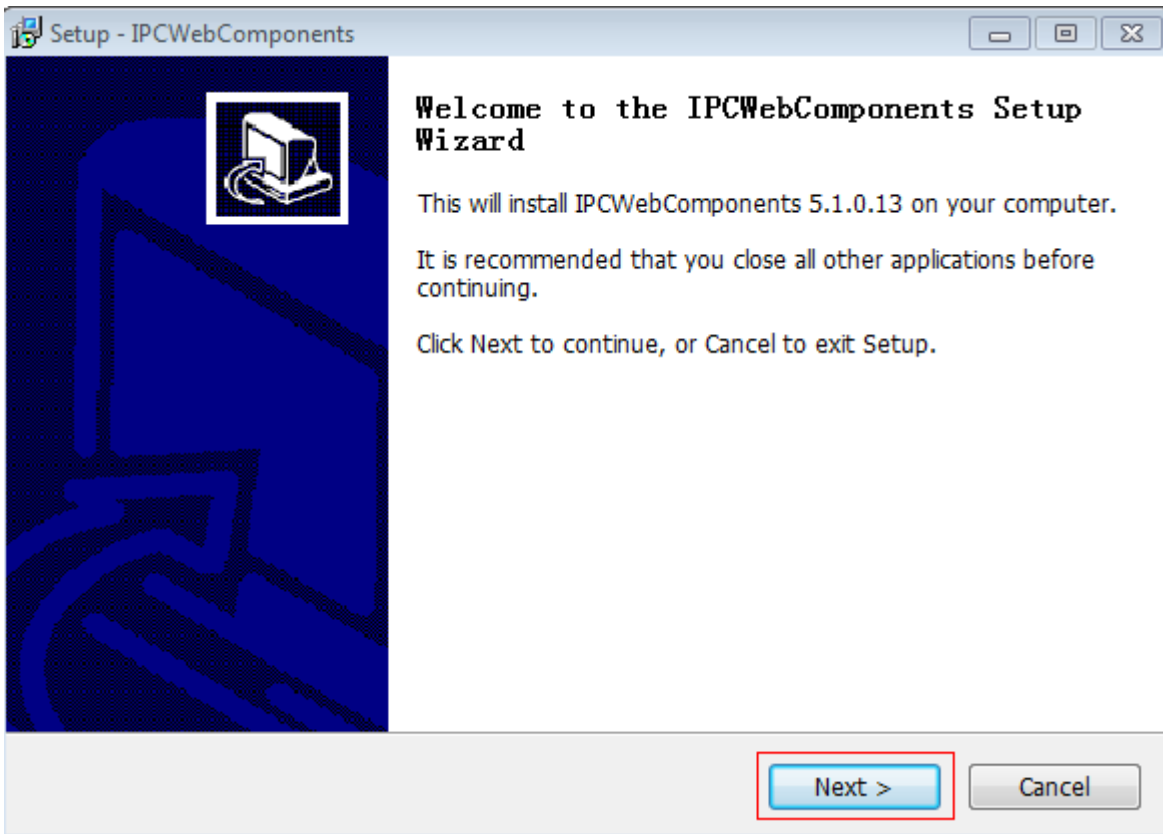

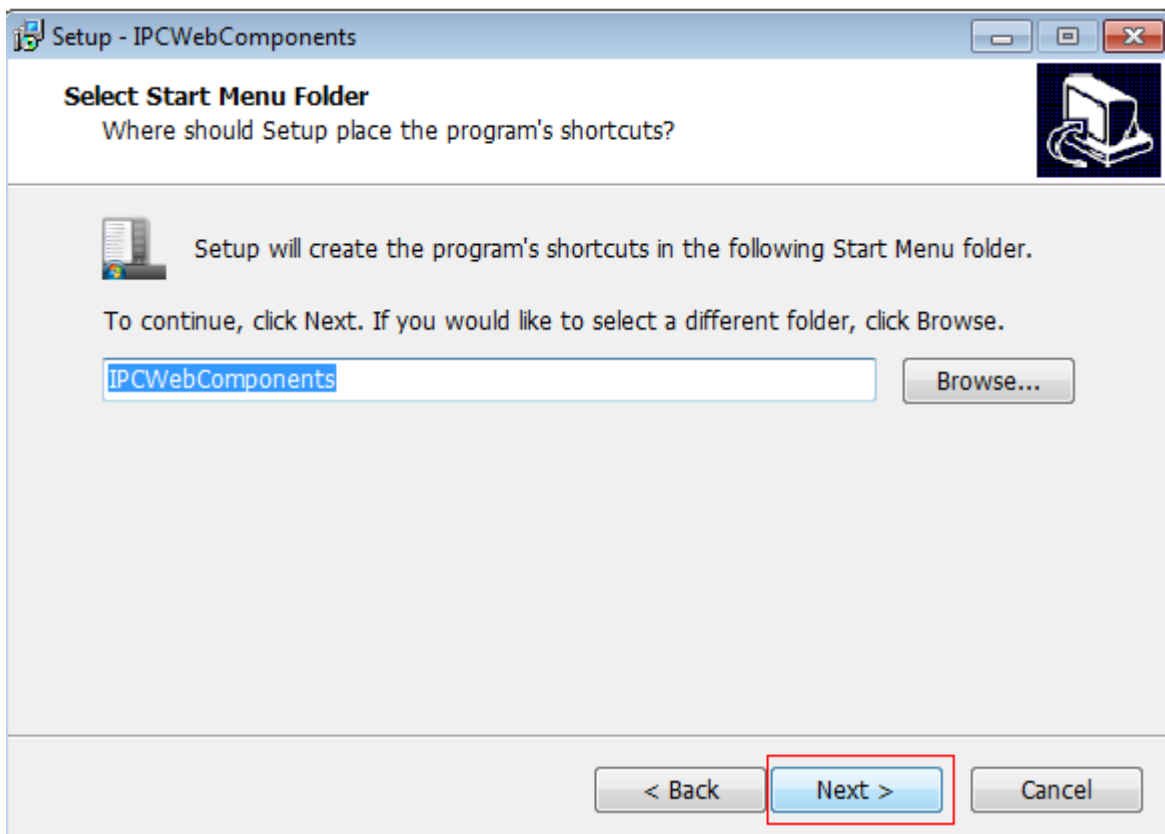
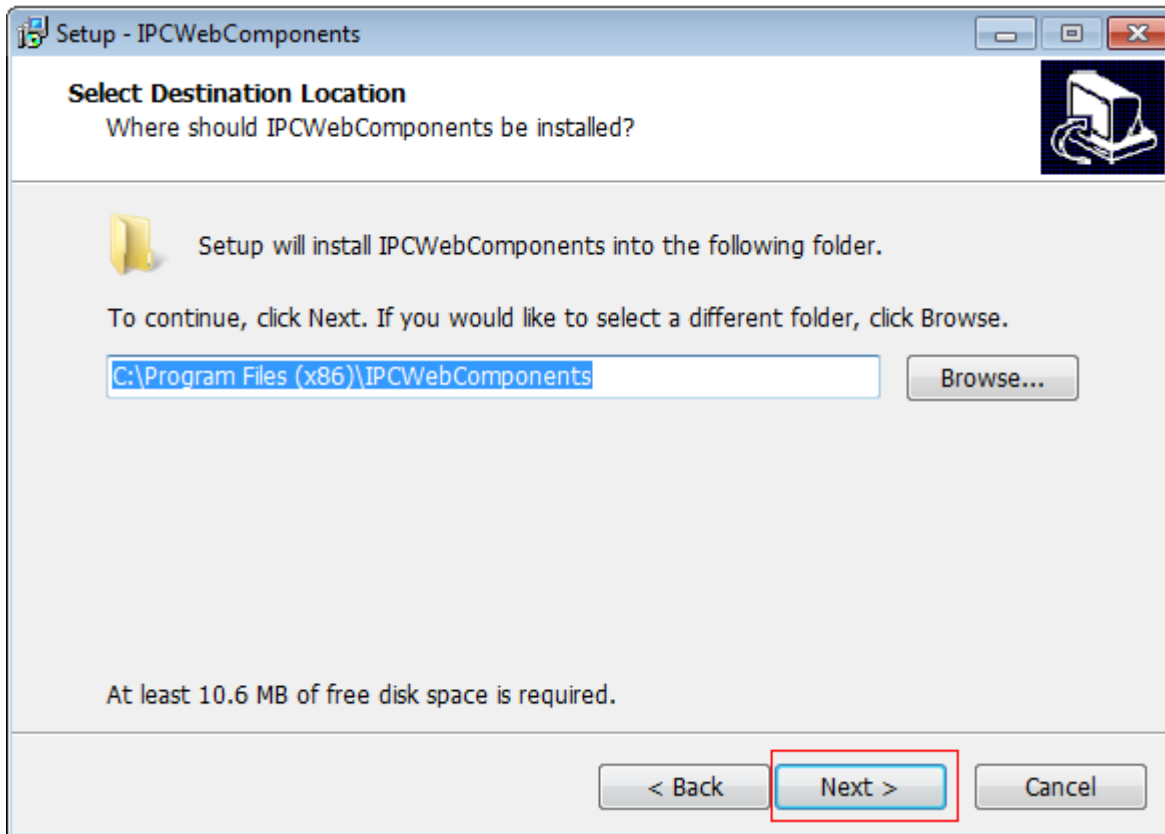

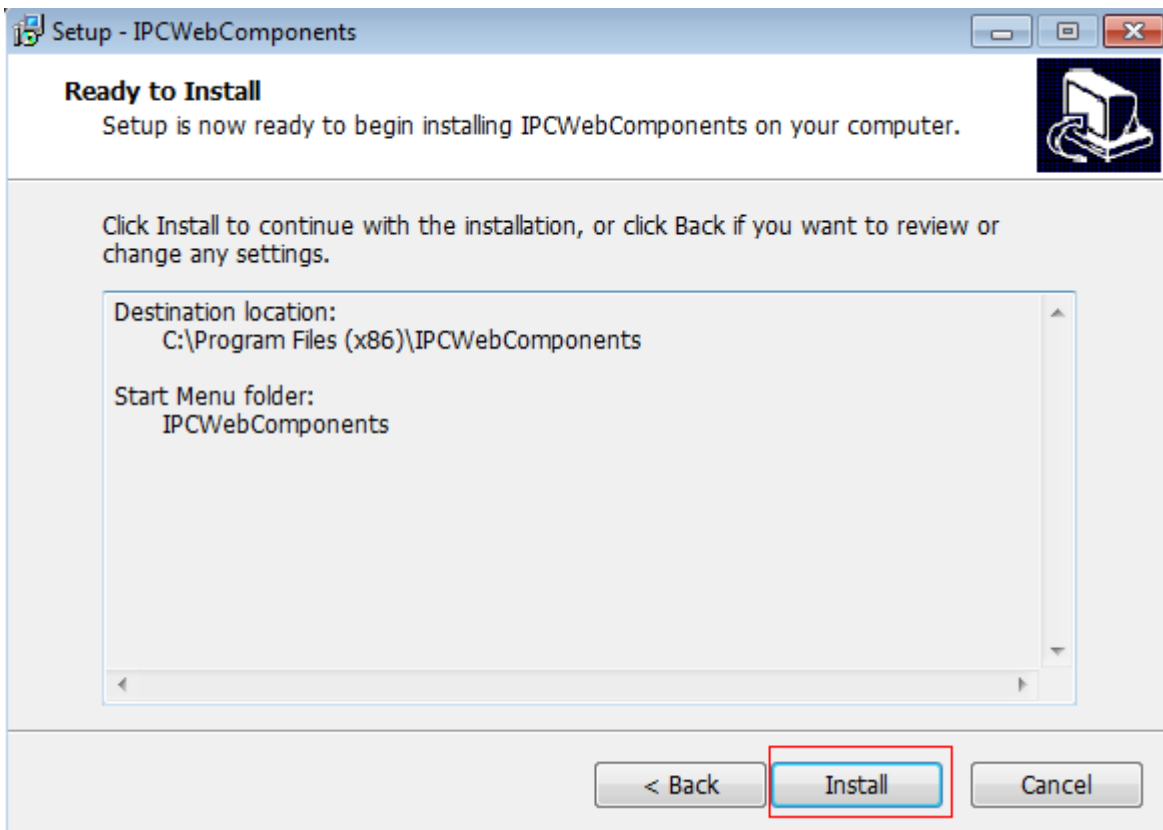

Step 4: Click **Finish** and reboot IE browser to log in the camera.

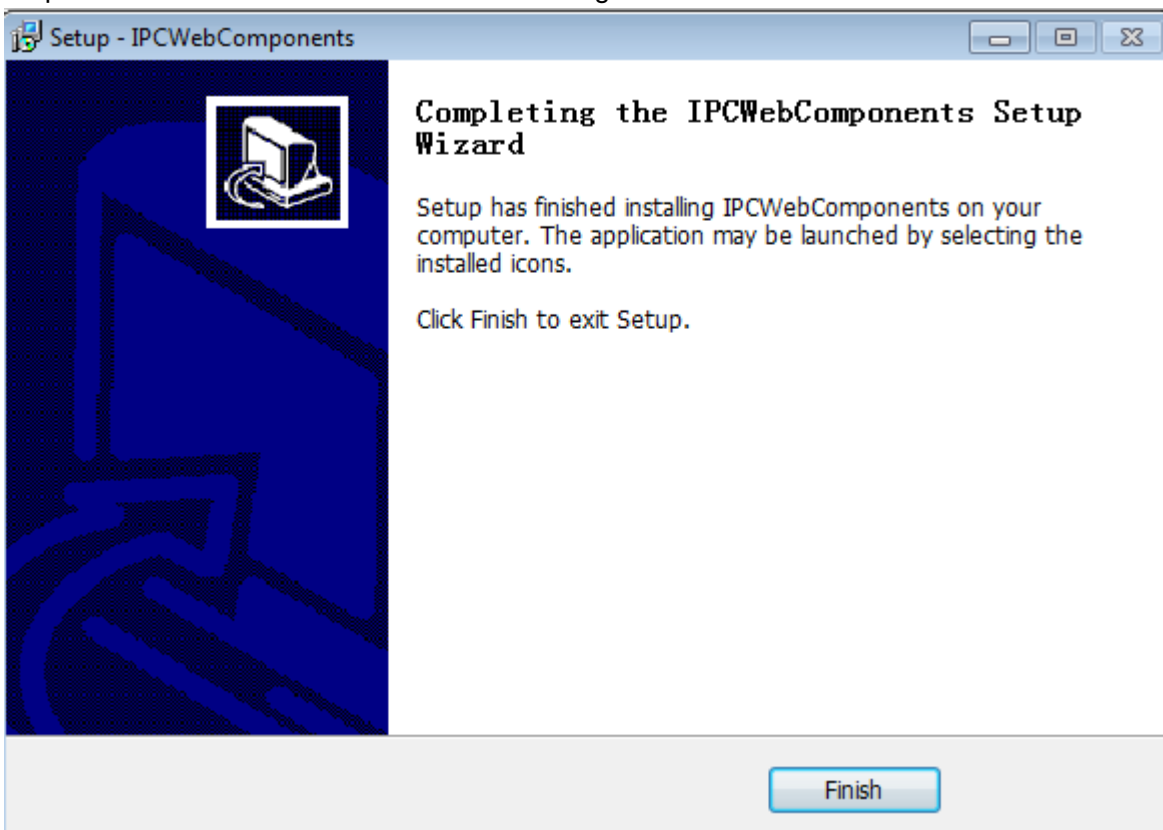

Note, for Safari on MAC OSX it'll show a link "Plugins are not found, click me to download" just above login windows of the camera. Please click it to download plugin and follow wizard to install. See this link for help if after installed plugin but still cannot login camera:

<http://www.foscam.com/faqs/view.html?id=14>

6.1.3 Unable to connect to router wirelessly

After setup wireless configuration, and input the wireless password correctly, save the settings. Normally, after you disconnect the Ethernet cable, wait for few minutes camera will show up again in Equipment Search Tool (or show up in router's DHCP client list/LAN list) with a new IP address. That indicates your camera's connected wirelessly.

If not, please follow below steps to help camera connect wirelessly.

Step1: Please make sure wireless signal is strong enough to connect with.

- (1) Make sure the camera antenna is fixed well;
- (2) Best to keep the distance between the camera and router in 2~3 meters while setup;
- (3) There's no interference or obstacles from house appliance or walls;

Step2: Please check the frequency band of the wireless signal.

The camera supports dual-band 2.4GHz & 5GHz WiFi, the speed of 5GHz WiFi is high but the penetrability is weak, so we suggest you use the 2.4GHz WiFi when there is a wall.

Step3: Please check if your wireless password contains special characters.

Remove special character in SSID and wireless password to have a try.

Step 4: Reboot camera and router to have a check.

If above are all confirmed, power off and on the camera and router may help camera to connect.

Step 5: Please log-in the router and check if the MAC filter feature is enabled.

Camera has wired and wireless MAC, they are different. If your router has wireless MAC filtering turned on, it'll block camera to connect. Please turn it off, or add camera's MACs in the allow list.

Step 6: Please change the wireless channel, and the wireless encryption of router to have a try.

Change channel helps reduce influence from nearby WiFi networks, you can try 3,6,or 11 for example.

As for encryption, suggest use WPA2/PSK AES.

Step7: At last reset camera to default, and please try re-configure the wireless settings again.

6.1.4 Forgot camera's user name and password

Camera can be hard reset to default settings, when you forgot camera's login user name and password.

Below are the steps:

- (1) Keep power on camera;
- (2) Press and hold reset button of camera for 30 second, till it reboots. Reset button is on bottom, or back, or end cords of the camera.
- (3) Once reset, camera will be restored to default settings. And default username is admin, no password (leave password blank).

6.1.5 How to setup alarm recording to SD card

For the cameras that support Mirco SD card, we can save alarm recording on Mirco SD card and below are the steps to set it up:

Step 1: Setup the Motion Detection Settings

Please go to **Settings > Alarm > Motion Detection** menu.

- (1) Click **Enable**.
- (2) Choose **Recording** for the alarm action.
- (3) Set the Detection Area
- (4) Set a Schedule.
- (5) Click **Save** to save the settings.

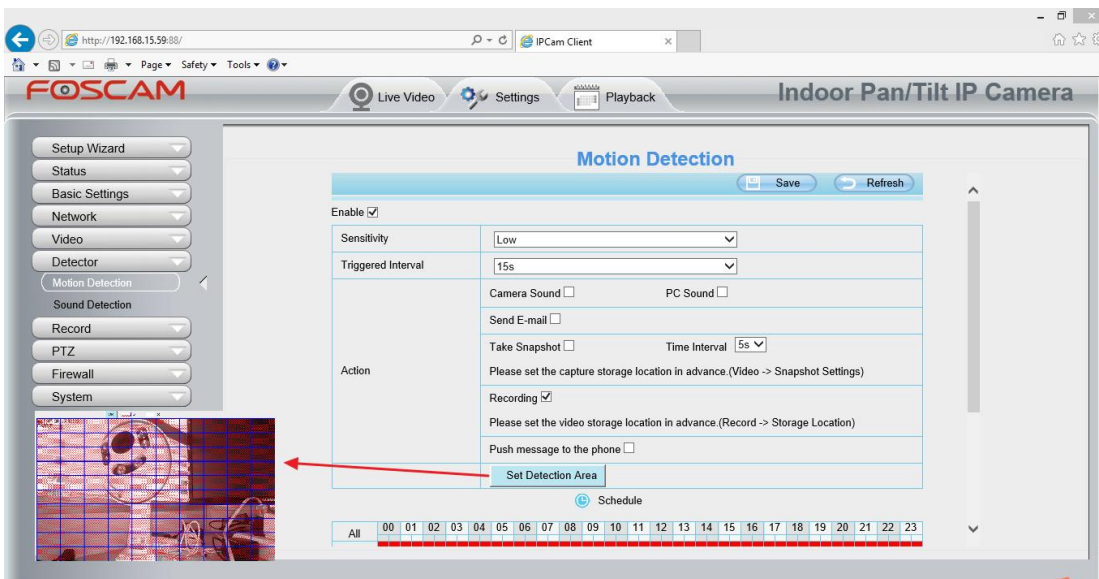

Note:

- 1) Please DO NOT forget to set the alarm schedule, the alarm schedule is red.
- 2) Please make sure your camera time is correct.
- 3) Please DO NOT forget to set the alarm area, the detected area is covered by the red grids. Or for some models you can setup 3 detection zones in total.

Step 2: Setup the Storage Location

Go to **Settings > Record > Storage Location**, and set the "Recording Location" to "SD card and click **Save**.

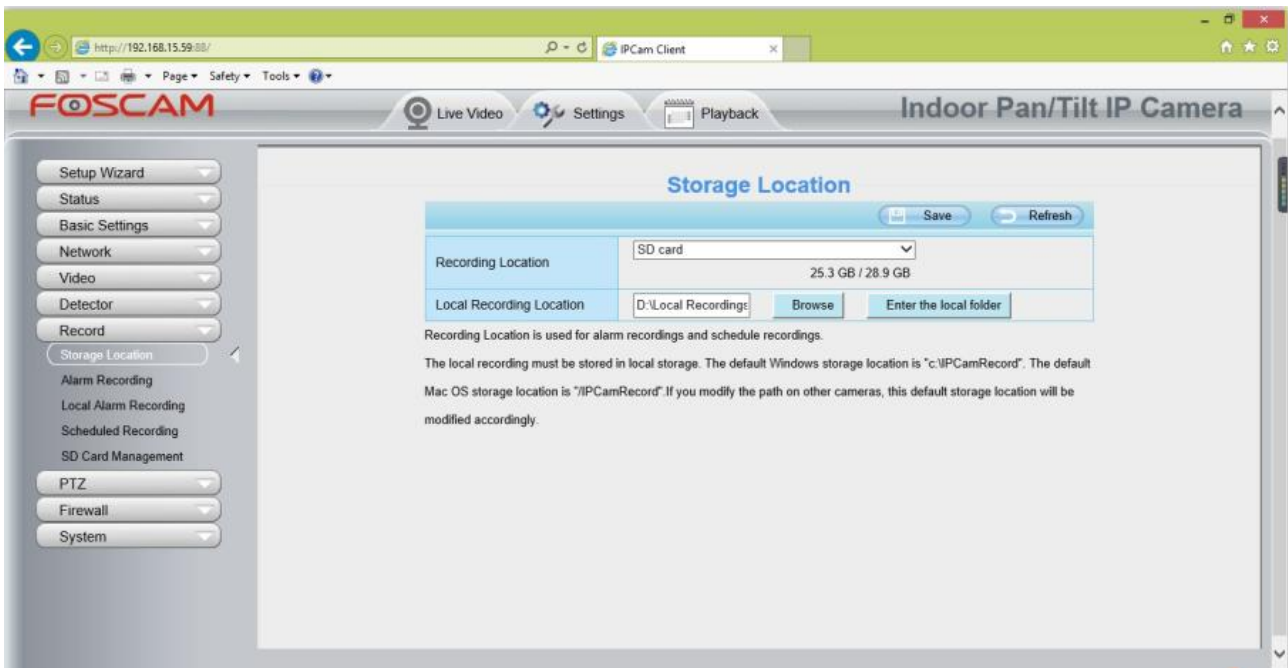

Note:

SD card needs FAT32 format to be identified by camera, and has enough space for saving the recordings. It's suggested use 4G~128G SD card.

6.1.6 How to setup alarm Emails

Setup alarm Emails, when camera detects a motion it'll send Email with snapshot to inform about the motion alarm. Steps as below.

Step 1: Setup Mail Settings

Before you set, please make sure that your email for sender enabled SMTP. And get your Email SMTP server, SMTP port, TLS information ready.

Please go to **Settings > Network > Mail Settings** menu to setup your email firstly.

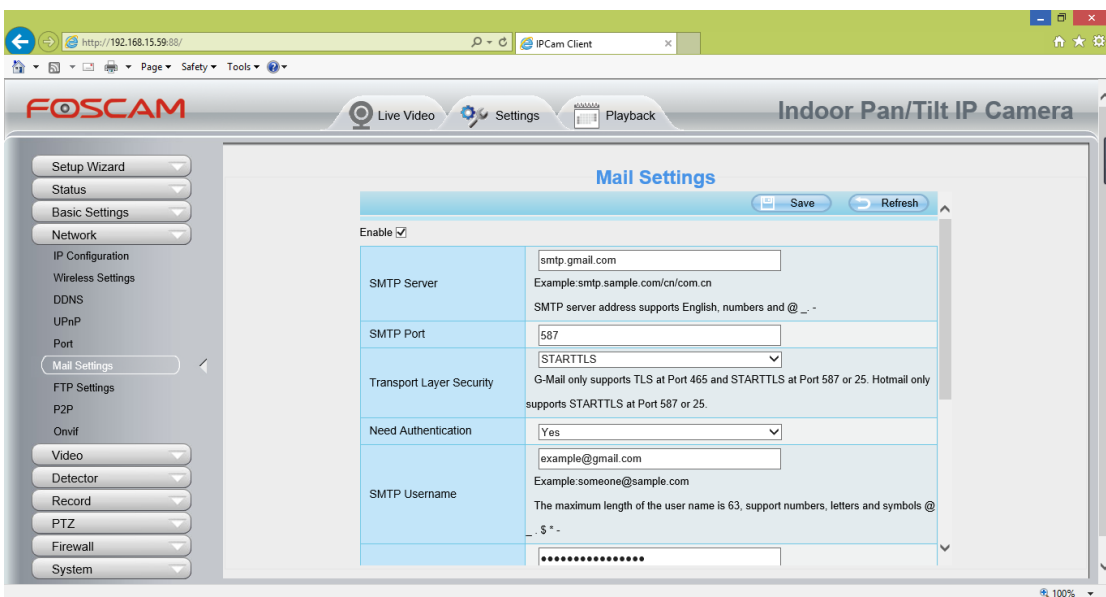

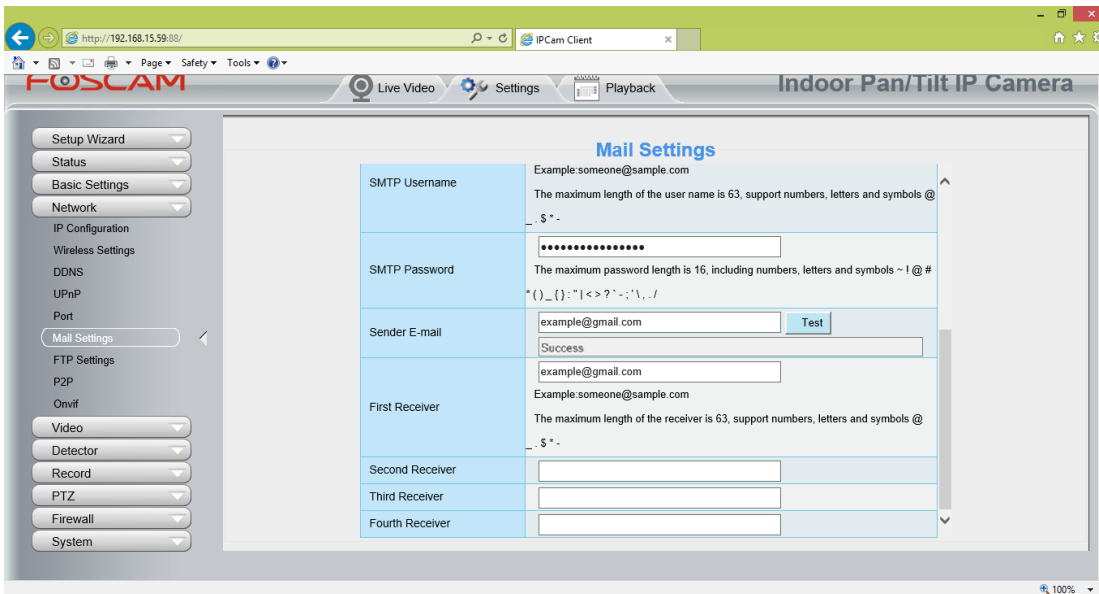

Note:

- (1) Please make sure that your sender email supports SMTP;
- (2) Please click on **Save** before you click on **Test**;
- (3) Make sure the test result is success.
- (4) After succeed, you will receive a test email in the mailbox of Sender.

Step 2: Setup the Motion Alarm Settings

Please go to **Settings > Alarm > Motion Detection** menu:

1. Click **enable**,
2. Choose **Send E-mail** for the alarm action,
3. set your detection area,
4. Set your schedule.

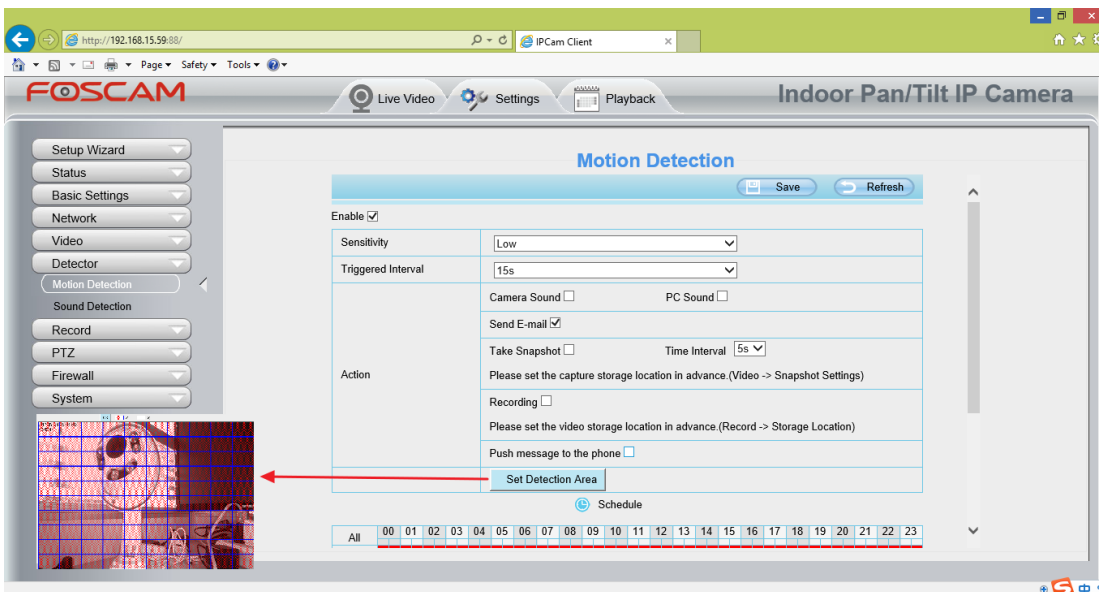

Do not forget to click on **Save** after you finish settings.

If there is motion trigger, camera will alarm and you can receive alarm emails.

Note:

- (1) Please DO NOT forget to set the alarm schedule, the alarm schedule is red.
- (2) Please make sure your camera time is correct.
- (3) Please DO NOT forget to set the alarm area, the detected area is covered by the red grids. Or for some models you can setup 3 detection zones in total.

6.1.7 Camera is not displaying image

Camera unable to show live image on web browser could be caused by multiple factors.

- (1) Plugin is not installed or running properly.

Please install plugin first, go to **IE Browser > Tool > Internet Option > Security > Custom Level > ActiveX control and Plug-ins**. Three options of front should be set to be **Enable**, The ActiveX programs read by the computer will be stored. As follows:

Enable: Download unsigned ActiveX controls.

Enable: Initialize and script ActiveX controls not marked as safe.

Enable: Run ActiveX controls and plug-ins.

- (2) Low network bandwidth that's unable to transfer image. Please lower resolution of the camera.
- (3) IR-cut is stuck at night when IR lights are on. In this case, manually turn off and on IR lights a few times.
- (4) Also, if camera's firmware is too old that doesn't support the browser and unable to install plugin will cause the same issue. Please update firmware of the camera to latest first.

6.1.8 Unable to connect camera remotely using Foscam app

Foscam P2P cameras allow users to connect camera remotely using Foscam app without extract setup like port forwarding. When it unable to connect remotely, below tips can help app establish the connection:

- (1) Update app and camera's firmware to latest version,
- (2) Power off the camera then power back on,
- (3) Delete camera from app then re-add it back, also lower camera's resolution.

6.1.9 Camera is added by others

When use myfoscam.com cloud or Foscam app, one camera can only be added to one account at the same time. To solve error "This camera has already been added by another account" when add camera to Foscam app or cloud, please send a clear photo of camera's model sticker to Foscam support email support@foscam.com to unbind it.

More FAQs are available here:

<https://www.foscam.com/faqs/index.html>

6.2 Default Parameters

Default network Parameters

IP address: obtain dynamically

Subnet mask: obtain dynamically

Gateway: obtain dynamically

Username and password

Default admin username: admin with a blank password

6.3 Specifications

ITEMS		C2M
Image Sensor	Sensor Type	1/2.9"CMOS
	Display Resolution	1920 x 1080 (2.0 Megapixels)
	Frame Rate	25fps
	Min. Illumination	0 Lux (With IR Illuminator)
Lens	Lens Type	f:2.8mm,F:2.6
	Angle of View	Horizontal:99° Diagonal :103°
Video	Image Compression	H.264
	Resolution	1080P(1920x1080),720P(1280 x 720), VGA(640 x 480), QVGA(320 x 240)
	Stream	dual stream
	Image adjustment	The brightness, contrast, saturation, sharpness are adjustable
	Flip image	flip and mirror
	Infrared mode	Automatic or manual
	Manual Pan/Tilt Angle	Horizontal:360° & Vertical: 180°
Audio	IR Range	High performance IR-LEDs, IR Range up to 8m(26ft)
	Input/Output	Supports two-way audio Built-in Mic & Speaker
	Audio Compression	PCM/G.726
Network	Ethernet	One 10/100Mbps RJ45 port
	Wireless Standard	IEEE802.11b/g/n/ac
	Data Rate	2.4GHz: IEEE802.11b: 11Mbps(Max.); IEEE802.11g: 54Mbps(Max.); IEEE802.11n: 150Mbps(Max.). 5GHz: IEEE802.11a: 54Mbps(Max.); IEEE802.11n: 150Mbps(Max.); IEEE802.11ac: 433Mbps(Max.).
	Frequency bands	2.4-2.4835GHz and 5.15-5.85GHz

	Wireless Security	WPA, WPA2
	Wireless Setup	Supports EZLink wireless setup
	Network Protocol	IP、TCP、UDP、HTTP、HTTPS、SMTP、FTP、DHCP、RTSP、WPS、ONVIF
	Remote Access	P2P
	Operating System	Microsoft Windows XP, 7, 8; Mac OS; iOS、Android
System Requirements	Browser	IE8 and above version;Firefox;Chrome;Safari.
	Motion Detection	Alarm via E-Mail, upload alarm snapshot to FTP
Other Features	WDR	Improve image clarity in complex scenario
	Magic Zoom	NA
	User Accounts	Three levels user role
	Firewall	Supports IP Filtering
	Storage	128G Micro SD card, local and FTP storage
	Reset	Reset button is available
	Power Supply	DC 5V/1.0A
	Power Consumption	4.8W (Max)
	Dimension(LxWxH)	70x70x120mm(2.8x2.8x4.7in)
Physical	Net Weight	165g(0.36lb)
	Operating Temperature	-10°C ~ 40° (14°F ~ 104°F)
Environment	Operating Humidity	20% ~ 85% non-condensing
	Storage Temperature	-20°C ~ 60° (-4°F ~ 140°F)
	Storage Humidity	0% ~ 90% non-condensing
Certification	CE, FCC, RoHS	

Attention: Power adapter should be used between 0°C-40°C, and 5%-90% relative humidity.

6.4 CE & FCC

Electromagnetic Compatibility (EMC)

FCC Statement



FCC Warning

This device complies with Part 15 of the FCC Rules. Operation is subject to the following two conditions: (1) This device may not cause harmful interference, and (2) this device must accept any interference received, including interference that may cause undesired operation. NOTE 1: This equipment has been

tested and found to comply with the limits for a Class B digital device, pursuant to part 15 of the FCC Rules. These limits are designed to provide reasonable protection against harmful interference in a residential installation. This equipment generates, uses and can radiate radio frequency energy and, if not installed and used in accordance with the instructions, may cause harmful interference to radio communications. However, there is no guarantee that interference will not occur in a particular installation. If this equipment does cause harmful interference to radio or television reception, which can be determined by turning the equipment off and on, the user is encouraged to try to correct the interference by one or more of the following measures: - Reorient or relocate the receiving antenna. - Increase the separation between the equipment and receiver. -Connect the equipment into an outlet on a circuit different from that to which the receiver is connected. -Consult the dealer or an experienced radio/TV technician for help.

This equipment complies with FCC radiation exposure limits set forth for an uncontrolled environment .This equipment should be installed and operated with minimum distance 20cm between the radiator& your body.

NOTE 2: Any changes or modifications to this unit not expressly approved by the party responsible for compliance could void the user's authority to operate the equipment.

CE Mark Warning



This is a Class B product. In a domestic environment, this product may cause radio interference, in which case the user may be required to take adequate measures.

6.5 Warranty

FOSCAM values your business and always attempts to provide you the very best of service.

No limited hardware warranty is provided by FOSCAM unless your FOSCAM product ("product") was purchased from an authorized distributor or authorized reseller. Distributors may sell products to resellers who then sell products to end users. No warranty service is provided unless the product is returned to an authorized return center in the region where the product was first shipped by FOSCAM or to the point-of-purchase, which may have regional specific warranty implications.

If you purchase your FOSCAM product from online store, please contact the point-of-purchase and ask for return/replacement/repair service.

Limited Hardware Warranty

- FOSCAM products are warranted to be free from manufacturing defects in materials and workmanship starting from the shipping date of FOSCAM.

This limited hardware warranty does not cover:

- Software, including the software added to the products through our factory-integration system, software that included in the CD,etc.
- Usage that is not in accordance with product instructions.
- Failure to follow the product instructions.
- **Normal wear and tear.**

Return Procedures

- Please read FOSCAM warranty policy & policy of your reseller first before sending items back to point-of-purchase.
- Customer must first contact point-of-purchase to obtain a Return Merchandise Authorization (RMA) number before returning the product. If the product you received is suspected to be defective and the product warranty has not expired, The RMA number will allow your reseller to track your return much easier and help them expedite processing your request.
- After receiving your RMA case number, pack the item(s) very well with the original box and all the original accessories included such as power adapters, brackets, cables, manuals, and driver CD disks.
- Write your RMA number and the return reason (the problem of the product) on the warranty card along with the complete package to send them back.

Replacement Services

- **If customers ask for replacement service, please contact point-of-purchase and follow their policy.**
- Our technicians will inspect all items returned for replacement requests. If the returned product is found in working order, we will return the same item received. However customers shall be responsible for all shipping & handling charges incurred for getting the units back to customers.
- If returned products are found defective, we will replace the product and assume the shipping cost for sending back the replacement unit to customers.
- If for any reason, we are unable to provide a replacement of the original returned item(s). You will have a choice for a "Substitute" item at the same equal value.
- We do not provide exchange and replacement due to normal hardware upgrade according the market after 14 days after the product is delivered.
- Our technicians will test the product before send out the replacement, any other demand for more than two times replacement for the same product during replacement limit will be rejected.
- **Replaced products are warranted from the balance of the former warranty period.**

Warranty Forfeiture

- Warranty is void if purchase from unauthorized distributor or reseller.
- Warranty is void if trade-mark, serial tags, product stickers have been removed, altered or tampered with.
- Warranty is void for mishandling, improper use, or defacing the product.
- Warranty is void for physical damage, altered, either internally or externally, improper or inadequate packaging when returned for RMA purposes.
- Warranty is void if damage has resulted from accident, dismantle, abuse, or service or modification by someone other than the appointed vendor, source, fission or the spare part has been over the period of warranty.
- Warranty is void if product is damaged due to improper working environment or operation. (For example, improper temperature, humidity, unusual physical or electrical stress or interference, failure or fluctuation of electrical power, static electricity, using wrong power adapter, etc.)
- Warranty is void if damaged by the use of parts not manufactured or sold by FOSCAM.
- Damage caused by improper installation of third-party products.

- Warranty is void if damaged for irresistible cause, such as earthquake, fire, lightning, flood, etc.
- Product beyond limited warranty.

Shipping Fee

- If products are defective or damaged under normal use or operation in the replacement limit, distributors or resellers are responsible for the shipping cost the product back to customers, customers should assume the shipping cost send the product to the point-of-purchase.
- During replacement limit, if customers ask for replacement due to the product does not fit for customer's personal expectation, customers should responsible for both shipping fee.
- Customers shall be responsible for both shipping fee if their product beyond the replacement limit but still in warranty limit.

Repair Service Out Of Warranty

- FOSCAM provide extra repair service for product that out of warranty, it is chargeable. The total fee contains device cost and service fee. Device cost (including accessories) is the standard uniform price provide by FOSCAM.
- Different region may have different service fee, please contact the point-of-purchase to confirm that before you ask for this service.
- Our technicians will quote the total price after detect the product, If customers refused to repair after the quotation, customers need pay for the test fee, \$3.5/hour. If agree with the quotation, test will be free.
- Repaired product out of warranty will obtains 3-month warranty from the date of the product back to customers.

Limitation of Liability

- FOSCAM is not responsible for other extra warranty or commitment promised by resellers, if your reseller promised some extra commitment or warranty; please ask for written documents to protect your rights and interests.
- FOSCAM does not offer refunds under any circumstances. Please contact the point-of-purchase and follow their refund/return policy.
- FOSCAM shall not be liable under any circumstances for any consequential, incidental, special or exemplary damages arising out of or in any connection with this agreement or the products, including but not limited to lost profits, or any claim based on indemnity or contribution, or the failure of any limited or exclusive remedy to achieve its essential purpose or otherwise. Purchaser's exclusive remedy, as against FOSCAM, shall be the repair or replacement of defective parts. If FOSCAM lists a product on its website specification in error or that is no longer available for any reason, FOSCAM reserves the right to explain it without incurring any liability.

All rights reserved. FOSCAM and the FOSCAM logo are trademarks of ShenZhen FOSCAM Intelligent Technology Limited., registered in the U.S. and other countries.

6.6 Statement

You are advised to be cautious in daily life, keep personal account information carefully, do not share personal account easily. Change passwords of your account and equipment periodically, and upgrade equipment firmware to strengthen security consciousness.

Our company makes no warranty, implied or otherwise, that this product is suitable for any particular purpose or use. You need to abide by the relevant laws and regulations of the use restrictions when using Foscam cameras. Our company takes no responsibility of illegal activities by using our products.

Our company takes no responsibility of the loss by force majeure, such as failure or faults of telecom system or the Internet network, computer viruses, malicious attacks of hackers, information damage or loss, and faults of computer system.

Foscam company does not need to take any responsibility of the special, incidental or corresponding loss by the products of our company or any software provide by our company, including but not limited to operating loss, profit or purpose. The company only takes the responsibility applicable to national and local legal requirements.

Our company takes no responsibility of the loss caused by the following at any time:

- 1) loss of purchases;
- 2) loss of intangible property damage, such as data, programs;
- 3) loss of compensation claimed by third-party customers.

Delete images, format the memory card or other data storage devices does not completely remove the original image data. You can restore deleted files from discarded the storage device by commercial software, but which will potentially lead to personal image data used maliciously by others. The privacy of the data security belongs to user responsibility, the company takes no responsibility.

Parts mentioned in this statement should not be understood by the configuration description of the product purchased by the customer, the product configuration must accord to the specific models purchased by the customer.

Without the prior written permission of Foscam company, all the contents of relevant operating instructions manual affiliated to the product must not be reproduced, transmitted, transcribed or stored in a retrieval system, or translated into other languages.

Our company will reserve the right to improve and modify the product and corresponding manuals. The company reserves the right of final interpretation on our products.

7 Obtaining Technical Support

While we hope your experience with the IPCAM network camera is enjoyable and easy to use, you may experience some issues or have questions that this User's Guide has not answered.

If you have problem with FOSCAM IP camera, please first contact FOSCAM reseller for solving the problems. If our reseller cannot provide service, please contact our service department:

support@foscam.com



CE Certificate Website: <https://www.foscam.com/company/ce-certificate.html>

Exporter and Importer Information Opened to Public:

<https://www.foscam.com/company/open-information.html>