

ALC™

CONNECT

Home Security Anytime from Anywhere

Wireless Security System



Models: AHS613 AHS616 AHS629

User Guide

Please read these instructions completely before operating this product.

IMPORTANT MODEL NUMBER INFORMATION

This manual covers three separate systems which will each include different devices. This manual may contain information on a device that is not included for your system but can be purchased separately by visiting:

ALCWireless.com

See pages 6-8 for information on what is included with your system.

IMPORTANT SAFETY INSTRUCTIONS 3

INTRODUCTION 6

 System Contents - AHS616..... 6

 System Contents - AHS613..... 7

 System Contents - AHS629..... 8

 Getting to Know Your Security System 9

GETTING STARTED 10

 Downloading the App 10

 Pairing the Devices/Sensors 10

 Pairing the Control Hub 11

 Pairing the Camera 13

 Pairing the Door/Window Sensor 15

 Pairing the Motion Detector 17

 Pairing the Remote Control..... 19

 Pairing the Indoor Siren..... 21

 Pairing the Power Switch 23

INSTALLATION 25

 Installation Tips 25

 Night Vision 26

 Installing the Camera 27

 Installing the Door/Window Sensor 27

 Installing the Motion Detector..... 28

 Installing the Siren..... 29

ALC CONNECT APP STATUS SCREEN 30

 Basic Operation 30

 Device Control 35

ALC CONNECT APP SCENARIO SCREEN 37

 One-Touch Scenario..... 37

 Sequene Scenario 39

ALC CONNECT APP EVENT SCREEN 41

 Operation 41

ALC CONNECT APP SETTING SCREEN 43

 Operation 43

SETTING UP THE Power Switch AS A REPEATER	45
Setup.....	45
TROUBLESHOOTING	46
Factory Default/Reset	47
PRODUCT SPECIFICATIONS	48
Control Hub	48
Camera	48
Remote Control	48
Motion Detector	49
Power Plug/Repeater.....	49
Siren.....	49
WARRANTY	50

PRODUCT SAFETY: When used in the directed manner, this unit has been designed and manufactured to ensure your personal safety. Improper use of this product can result in potential electrical shock or fire hazards. Please read all safety and operating instructions carefully before installation and use, and keep these instructions handy for future reference.

CAUTION

**RISK OF ELECTRIC SHOCK
DO NOT OPEN**



CAUTION: To reduce the risk of electric shock do not remove cover (or back). No user serviceable parts inside. Refer servicing to qualified service personnel.

DANGEROUS VOLTAGE: The lightning flash with arrowhead, within an equilateral triangle, is intended to alert the user to the presence of uninsulated dangerous voltage within the product's enclosure that may be of sufficient magnitude to constitute a risk of electric shock to persons.

ATTENTION: The exclamation point within an equilateral triangle is intended to alert the user to the presence of important operating and maintenance (servicing) instructions in the literature accompanying the appliance.

WARNING: TO PREVENT FIRE OR SHOCK HAZARD, DO NOT EXPOSE THIS UNIT TO RAIN OR MOISTURE.



Products with CE Marking comply with EMC Directive (2004/108/EC); Low Voltage Directive (73/23/EEC); R&TTE(1999/5/EC); ROHS Directive (2011/65/EU) issued by the Commission of the European Community. Compliance with these directives implies conformity to the following European Norms:

EMC: EN 301 489 LVD: EN 60950 Radio: EN 300 328



FCC Compliance Statement: This device complies with Part 15 of the FCC rules. Operation is subjected to the following two conditions: (1) this device may not cause harmful interference, and (2) this device must accept any interference received, including interference that may cause undesired operation.

FCC/CE WARNING

This equipment has been tested and found to comply with limits for a Class B digital device, pursuant to Part 15 of the FCC rules and ETSI(EN) 300328. These limits are designed to provide reasonable protection against harmful interference in residential installations. This equipment generates, uses, and can radiate radio frequency energy, and if not installed and used in accordance with the instructions, may cause harmful interference to radio communications. However, there is no guarantee that interference will not occur in a particular installation. If this equipment does cause interference to radio or television equipment reception, which can be determined by turning the equipment off and on, the user is encouraged to try to correct the interference by one or more of the following measures:

- Reorient or relocate the receiving Antenna.
- Move the equipment away from the Monitor.
- Plug the equipment into an outlet on a circuit different from that to which the Monitor is connected.
- Consult the dealer or an experienced radio/television technician for additional suggestions.

CAUTION: Any changes or modifications to this equipment not expressly approved by the party responsible for compliance could void your authority to operate the equipment.

Recycling and Disposal Information:

- Do not dispose of electronic devices or any of their components (especially batteries and LCD displays) in your municipal trash collection.
- Consult your local waste management authority or a recycling organization like Earth911.com to find an electronics recycling facility in your area.

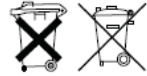

CAUTION: Rechargeable batteries must be recycled or disposed of properly.

WARNING:

STRANGULATION HAZARD: Infants have STRANGLED in power cords. Keep power cords more than three feet away from cribs, bassinets, play yards, and other safe sleep environments for infants.

IMPORTANT SERVICE SAFETY INSTRUCTIONS

Damages caused by non-compliance with this operating manual will void the warranty!

1. Read and Follow Instructions - All the safety and operating instructions should be read before the product is operated. Follow all operating instructions.
2. Retain Instructions - The safety and operating instructions should be retained for future reference.
3. Heed Warnings - Comply with all warnings on the product and in the operating instructions.
4. Power Sources - This product should be operated only from the type of power source indicated on the marking label. If you are not sure of the type of power supplied to your location, consult your video dealer or local power company. For products intended to operate from battery power, or other sources, refer to the operating instructions.
5. Overloading - Do not overload wall outlets or extension cords as this can result in the risk of fire or electric shock. Overloaded AC outlets, extension cords, frayed power cords, damaged or cracked wire insulation, and broken plugs are dangerous. They may result in a shock or fire hazard. Periodically examine the cord, and if its appearance indicates damage or deteriorated insulation, have it replaced by your service technician.
6. Power-Cord Protection - Power supply cords should be routed so that they are not likely to be walked on or pinched by items placed upon or against them. Pay particular attention to cords at plugs, convenience receptacles, and the point where they exit from the product.
7. Surge Protectors - It is highly recommended that the video equipment be connected to a surge protector. Doing so will protect the equipment from damage caused by power surges. Surge protectors should bear the UL listing mark or CSA certification mark.
8. Uninterruptible Power Supplies (UPS) - Because this product is designed for continuous, 24/7 operation, it is recommended that you connect the product to an uninterruptible power supply. An uninterruptible power supply has an internal battery that will keep the product running in the event of a power outage. Uninterruptible power supplies should bear the UL listing mark or CSA certification mark.

CAUTION: Maintain electrical safety. Power line operated equipment or accessories connected to this product should bear the UL listing mark or CSA certification mark on the accessory itself and should not be modified so as to defeat the safety features. This will help avoid any potential hazard from electrical shock or fire. If in doubt, contact qualified service personnel.

9. Ventilation - Slots and openings in the case are provided for ventilation to ensure reliable operation of the product and to protect it from overheating. These openings must not be blocked or covered. The openings should never be blocked by placing the video equipment on a bed, sofa, rug, or other similar surface. This product should never be placed near or over a radiator or heat register. This product should not be placed in a built-in installation such as a bookcase or rack unless proper ventilation is provided and the product manufacturer's instructions have been followed.
10. Attachments - Do not use attachments unless recommended by the product manufacturer as they may cause a hazard.
11. Water and Moisture - Do not use receivers or video monitors near water — for example, near a bath tub, wash bowl, kitchen sink or laundry tub, in a wet basement, near a swimming pool and the like.
12. Heat - The product should be situated away from heat sources such as radiators, heat registers, stoves, or other products (including amplifiers) that produce heat.
13. Accessories - Do not place this video equipment on an unstable cart, stand, tripod, or table. The video equipment may fall, causing serious damage to the product. Use this product only with a cart, stand, tripod, bracket, or table recommended by the manufacturer or sold with the product. Any mounting of the product should follow the manufacturer's instructions and use a mounting accessory recommended by the manufacturer.
14. Camera Extension Cables - Check the rating of your extension cable(s) to verify compliance with your local authority regulations prior to installation.
15. Mounting - The cameras provided with this system should be mounted only as instructed in this guide or the instructions that came with your cameras, using the provided mounting brackets.
16. Camera Installation - Cameras are not intended for submersion in water. Not all cameras can be installed outdoors. Check your camera's environmental rating to confirm if it can be installed outdoors. When installing cameras outdoors, installation in a sheltered area is recommended.









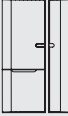

BATTERY PRECAUTIONS

Follow these precautions when using batteries in this device:

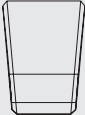
1. Warning – Danger of explosion if battery is incorrectly replaced. Replace only with the same or equivalent type.
2. Use only the size and type of batteries specified.
3. Be sure to follow the correct polarity when installing the batteries as indicated in the battery compartment. A reversed battery may cause damage to the device.
4. Do not mix different types of batteries together (e.g. Alkaline, Rechargeable and Carbon-zinc) or old batteries with fresh ones.
5. If the device is not to be used for a long period of time, remove the batteries to prevent damage or injury from possible battery leakage.
6. Do not try to recharge a battery not intended to be recharged; it can overheat and rupture. (Follow battery manufacturer's directions.)
7. Remove batteries promptly if consumed.
8. Clean the battery contacts and also those of the device prior to battery installation.



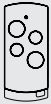



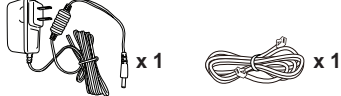

System Contents - AHS613

After unpacking, you will have the following items:

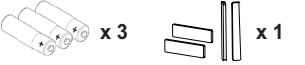
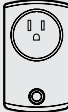
<p>Control Hub X 1</p>		 x 1	 x 1	
<p>Door/Window Sensor X 1</p>		 x 1	 x 1	
<p>Indoor Siren X 1</p>		 x 1	 x 1	 x 1
<p>Remote Control X1</p>		 x 1		



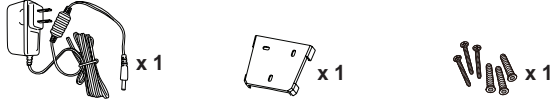









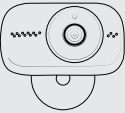

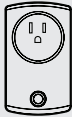

System Contents - AHS616

After unpacking, you will have the following items:

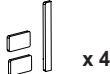
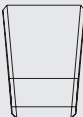
<p>Control Hub X 1</p>		 <p>Adaptor DC 12V/1A Ethernet Cable</p>
<p>Motion Detector X 1</p>		 <p>Battery AA 1.5V Sticky Pad Set</p>
<p>Power Switch X 1</p>		
<p>Door/Window Sensor X 2</p>		 <p>Battery CR2032 Sticky pad Set</p>
<p>Indoor Siren X 1</p>		 <p>Adaptor DC 5V/1 A Bracket Screw Set</p>
<p>Remote Control X1</p>		 <p>Battery CR2032</p>

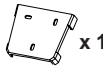
System Contents - AHS629

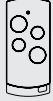



After unpacking, you will have the following items:

<p>Control Hub X 1</p>		 x 1	 x 1	<p>Adaptor DC 12V/1A Ethernet Cable</p>	
<p>Wireless Camera X 1</p>		 x 1	 x 1	<p>Adaptor DC 5V/1.5A Bracket</p>	
<p>Motion Detector X 2</p>		 x 6	 x 2	<p>Battery AA 1.5V Sticky Pad Set</p>	
<p>Power Switch X 1</p>					
<p>Door/Window Sensor X 4</p>		 x 4	 x 4	<p>Battery CR2032 Sticky pad Set</p>	
<p>Indoor Siren X 1</p>		 x 1	 x 1	 x 1	<p>Adaptor DC 5V/1 A Bracket Screw Set</p>
<p>Remote Control X1</p>		 x 1			<p>Battery CR2032</p>

Getting to Know Your Security System

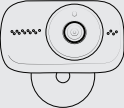
The AHS616 is an upgradeable security system that comes with everything you need to start protecting your home. You can increase security at any time by adding additional sensors and/or cameras. The system is easily accessed anywhere in the world via Internet. The free iOS/Android App allows you to view/record video, turn power switch(es) on/off, activate/deactivate the siren manually or automatically. Please read the manual fully to understand all the features the system and App contain.

See below for explanation of each device:

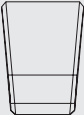
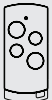
Control Hub		The central control of the Secure Home Connect system provides communication for remote access, sensors and mobile devices. The Control Hub can send out push notifications and Emails when a sensor is triggered.
Wireless Camera		The Wireless Camera will supply day and night viewing thanks to the built-in night vision. Using the free Android or iOS App, you can view live at any time, and set it up to record when an event is triggered (i.e. window sensor, etc.).
Motion Detector		The Motion Detector (PIR) is built for larger area detection, such as a living room or entrance. Once motion is detected, the Motion Detector can alert the system and activate the Power Switch (turning on light), Siren (alert sound) and Camera (view/record), if set.
Power Switch		Note: To conserve battery power, the Motion Detector will be temporarily deactivated for two minutes after every trigger event.
Door/Window Sensor		The Power Switch can be controlled via App (On/Off) and set to turn on after a Door/Window Sensor or PIR is triggered) or Panic button is pressed on the Remote Control. The Power Switch can also act as repeater to extend the service range for one single device, such as the Indoor Siren.
Indoor Siren		The Door/Window Sensor is installed on a door or window and when triggered (separated), it can activate the Power Switch (to turn on a light, etc.), activate the siren, etc. depending on the App settings.
Remote Control		The Indoor Siren can be controlled via the App and Panic button on the remote control or triggered by other devices such as Camera, Door/Window Sensor and Motion Detector.
		Use the Remote Control to ARM/DISARM the system or set off Siren. You can preset the buttons to operate various sequences of events with the paired devices.

Downloading the App

1 Download the ALC Connect App as follows:

APPLE DEVICE:

From your iPhone or iPad, go to the App Store and search for ALC Connect.

ANDROID DEVICE:

From your Android smartphone or tablet device, go to Google Play and search for ALC Connect.



Pairing the Devices/Sensors

The devices/sensors require sufficient battery power for successful pairing process and normal operation afterwards. If you cannot pair the sensor(s) to the control hub or they do not operate properly, please first replace the battery supplied with a new one to resolve the issue.

PAIRING:

- All accessories are paired with the Control Hub at the factory. See following pages to pair them again or if additional accessories are purchased.

Pairing the Control Hub

- 1 Connect the supplied Ethernet cable from the router to the Ethernet jack on the back of the Control Hub.

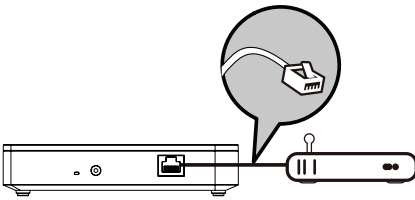

- 2 Connect one end of the AC Adaptor to the DC IN jack on the rear of the Control Hub and the other end to a 120 volt AC (standard indoor) power outlet; the Red Power indicator will light and the unit will beep twice to indicate that the Control Hub is ready to set up.

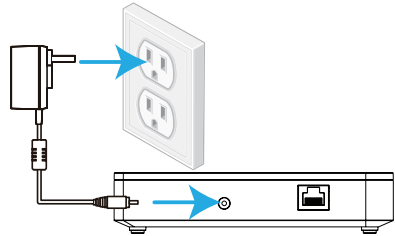

- 3 Launch the previously installed ALC Connect App. At the next screen, tap **Next**, then tap **Next** again.

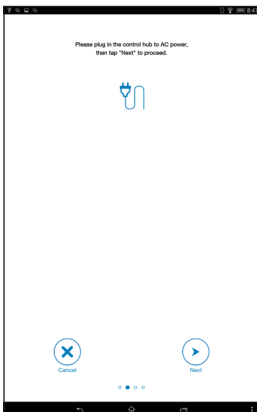

- 4 The app will search for the Control Hub and retrieve the DID automatically. If it does not detect, then tap **Next** and manually enter the DID code located on the bottom of the Control Hub.

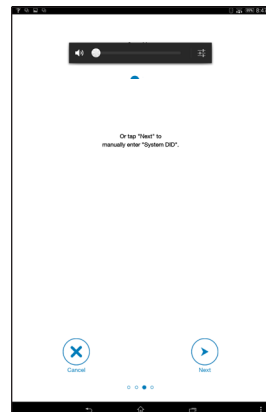

Pairing the Control Hub

5 The following screen will appear; enter the desired System name and the security code, if not in already. The default security code is 123456.

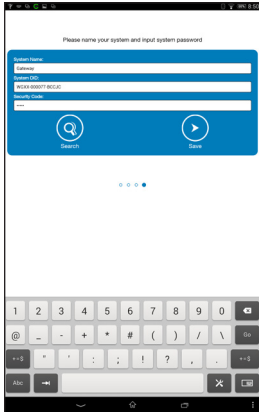

6 The newly added Control Hub is now added.

NOTES:

- If the Control Hub DID/Security Code cannot be retrieved, please check to make sure the Control Hub is powered on and the Ethernet cable is securely connected to the Wi-Fi router.
- The Control Hub should be powered on and connected to the Wi-Fi router at all times.

7 If not on the Control Hub screen already, tap the Control Hub System Name you gave to enter the main Status screen.

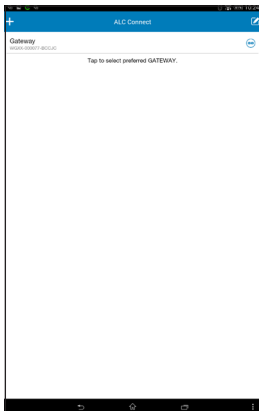

8 The Status screen will appear. Continue with Pairing the camera(s), sensor(s), switch(es) and remote control as shown in the following sections.

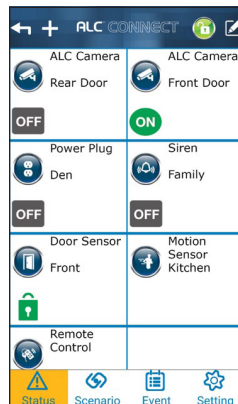

Pairing the Camera

Model AHS613 does not include a Camera. (**Note:** Any SightHD camera will work.)

- 1 Connect the small end of the AC adaptor to the Camera's DC IN jack. Plug the other end of the adaptor to a 120 volt AC (standard indoor) power outlet. After 30-60 seconds, the red Power Status LED will repeatedly blink three times rapidly.

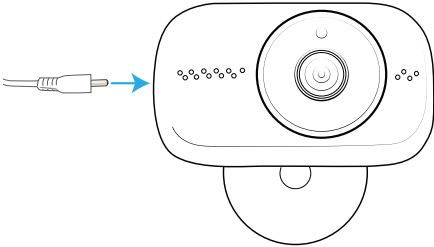

- 2 Insert an SD Card (up to 32GB - not included) into the SD Card Slot. This will allow you to record videos.

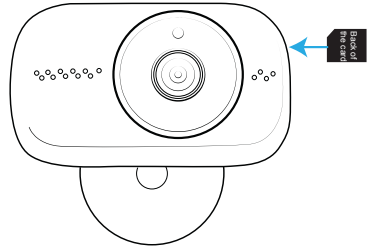

- 3 At the Status screen, tap +.

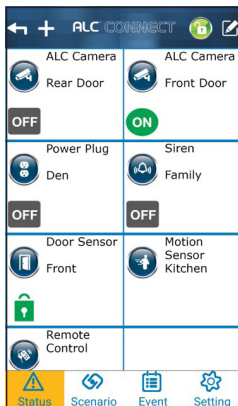

- 4 Tap **Camera**.

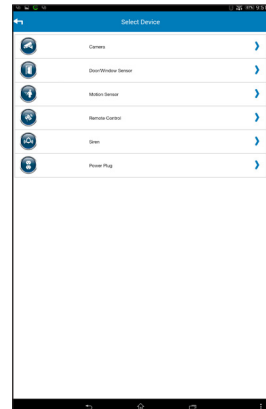

Pairing the Camera

5 Tap **Next**; the App will then search for the camera (this could take up to two minutes). If it does not detect, then manually enter the DID code located on the camera.

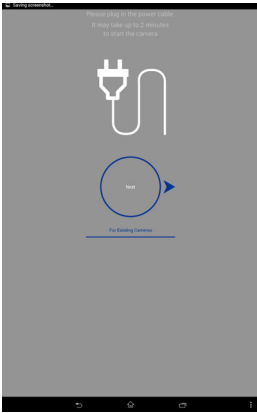

6 At the next screen, select the Camera. You may be asked to change the password and to select a Wi-Fi Network.

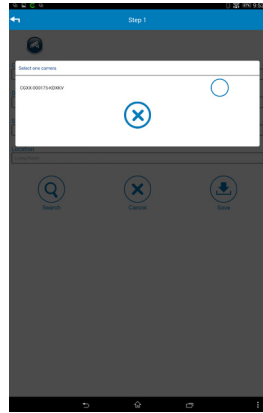

7 The following screen will appear; enter the desired Camera name, the Security Code and the Location. The default security code is 123456. Tap **Save**.

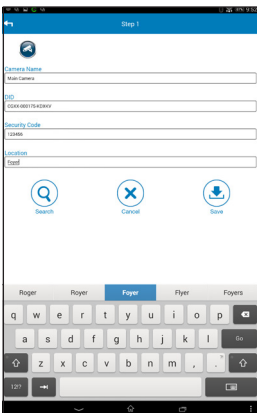

Pairing the Door/Window Sensor

- 1 The Door/Window Sensor comes with a pre-installed CR2032 battery. If it needs replacing, simply remove the cover by sliding it downwards and replace with a new CR2032 battery.

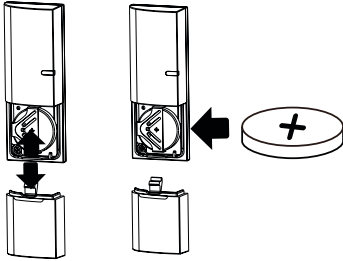

- 2 At the Status screen, tap +.

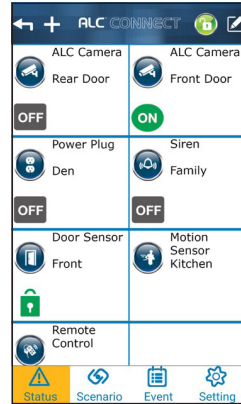

- 3 Tap **Door/Window Sensor**.

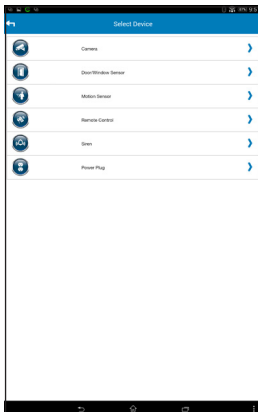

- 4 Tap **Pair** to start the Pairing process. Follow the on screen instructions.

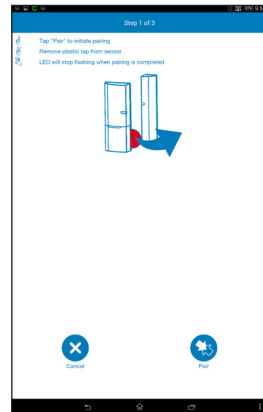

Pairing the Door/Window Sensor

5 For initial setup, remove the insulating plastic tab; the App will then search for the sensor. If it does not detect, then manually see step 6. If detected, continue to step 7.

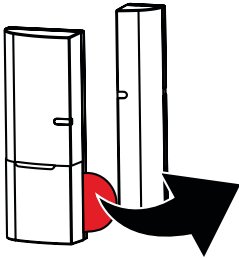

6 If it did not detect the sensor, pair manually by removing the battery cover and then reinstalling it (this will activate the manual pairing). The button for pairing is on the upper right of the battery.



7 The following screen will appear; enter the desired Sensor's name and the location.

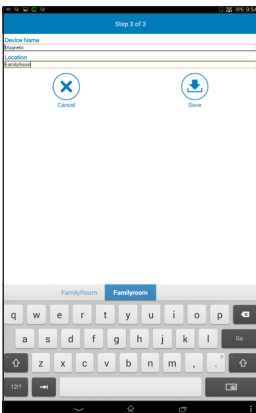

8 Tap **Save**.

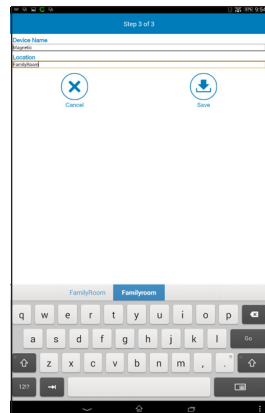

Pairing the Motion Detector

- 1 The Motion Detector comes with three pre-installed AA batteries. If they need replacing, press the tab at the bottom of the sensor and insert three AA size batteries following the diagram in the compartment.

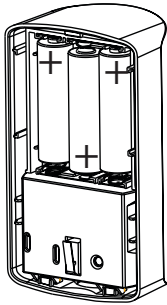

- 2 At the Status screen, tap +.

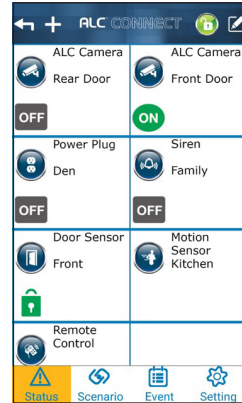

- 3 Tap **Motion Detector**.

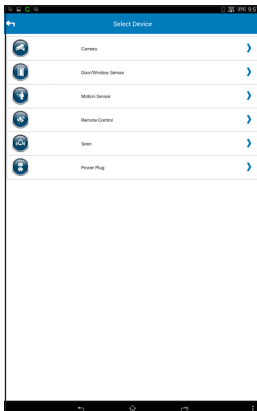

- 4 Tap **Pair** to start the Pairing process. Follow the on screen instructions.

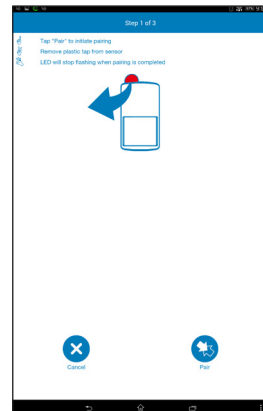

Pairing the Motion Detector

5 For initial setup, remove the insulating plastic tab; the App will then search for the sensor. If it does not detect, see step 6; if detected, skip step 6 and continue with step 7.

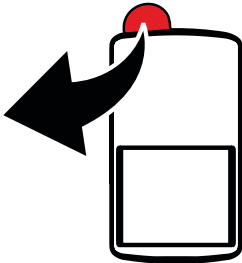

6 If it did not detect the sensor, pair manually by removing the battery cover and then press the Pair button.

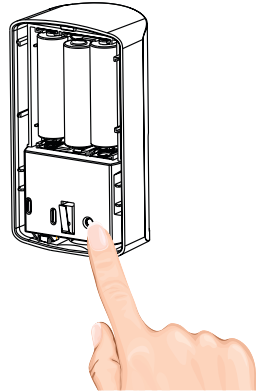

7 The following screen will appear; enter the desired Sensor's name and the location.

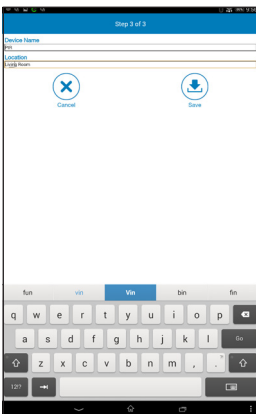

8 Tap **Save**.

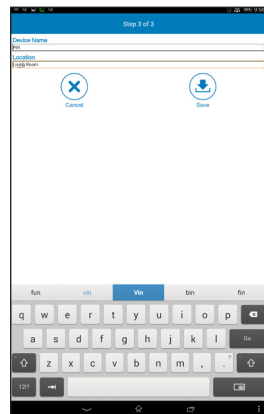

Pairing the Remote Control

- 1 The Remote Control comes with a pre-installed CR2032 battery. If it needs replacing, simply pull out the battery compartment on the side of the Remote Control and replace with a new CR2032 battery.

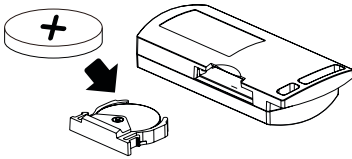

- 2 At the Status screen, tap +.

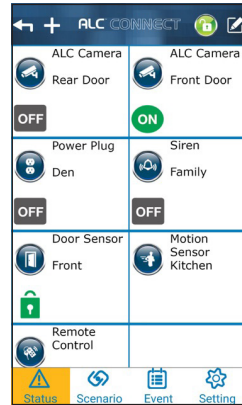

- 3 Tap **Remote Control**.

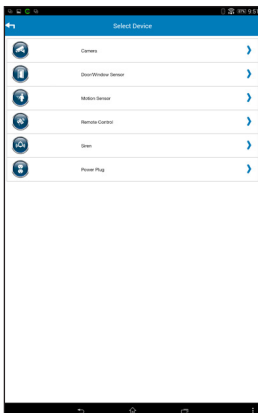

- 4 Tap **Pair** to start the Pairing process. Follow the on screen instructions.

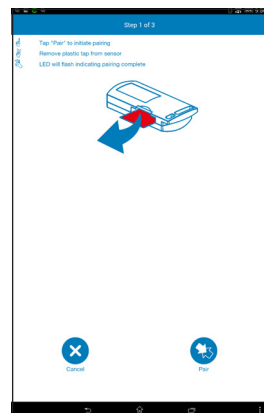

Pairing the Remote Control

5 For initial setup, remove the insulating plastic tab; the App will then search for the Remote Control. If it does not detect, see step 6. If detected, continue to step 7.

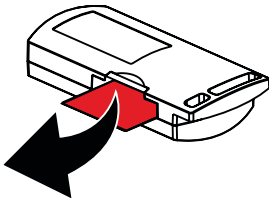

6 If it did not detect the Remote Control, press and hold the Armed Stay button on the Remote Control until the blue LED blinks.

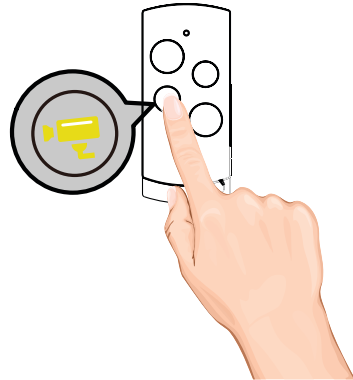

7 The following screen will appear; enter the desired Remote Control's name and the location.

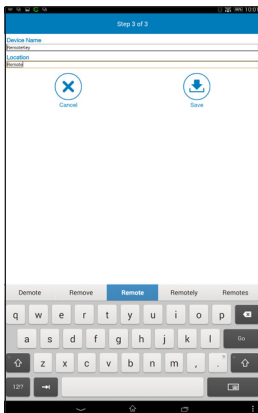

8 Tap **Save**.

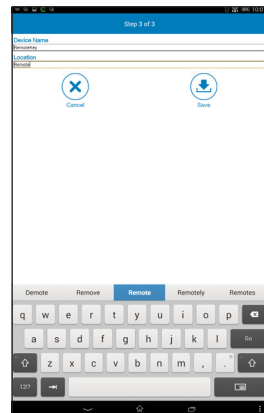

Pairing the Indoor Siren

- 1 The indoor Siren can be operated via the AC Power supply or batteries. To use batteries, press the tab on the battery compartment cover and lift off. Insert four AA size batteries (not included) following the diagram in the compartment.

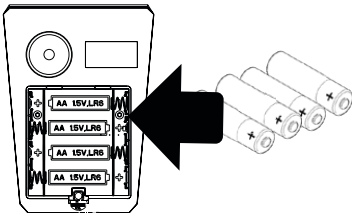

- 2 To use with AC, connect the small end of the AC adaptor to the Indoor Siren's DC IN jack. Plug the other end of the adaptor to a 120 volt AC (standard indoor) power outlet.

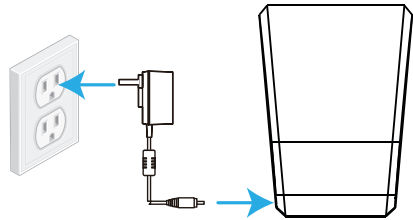

- 3 At the Status screen, tap +.

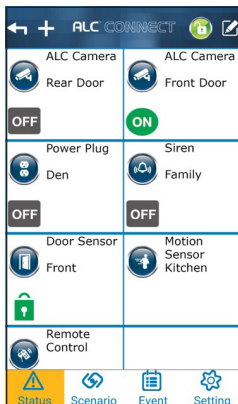

- 4 Tap **Siren**.

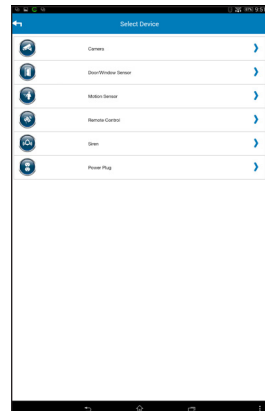

Pairing the Indoor Siren

5 Tap **Pair** to start the Pairing process. Follow the on screen instructions.

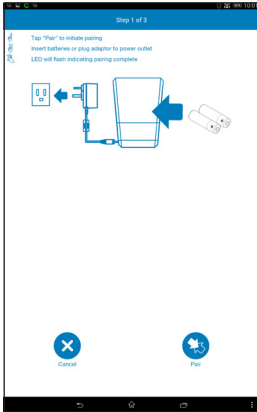

6 The App will then search for the Indoor Siren. If the App did not detect the Siren, press the Pair button located inside the battery compartment in the back.

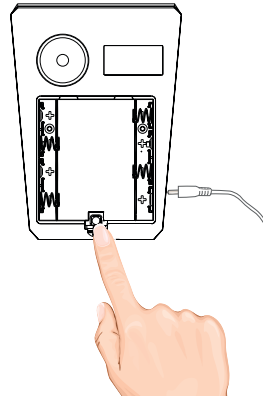

7 The following screen will appear; enter the desired Siren's name and the location.

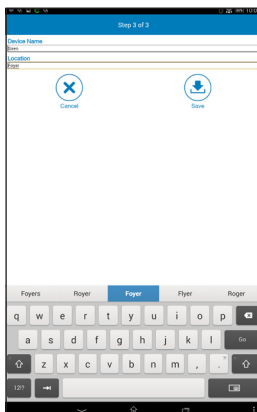

8 Tap **Save**.

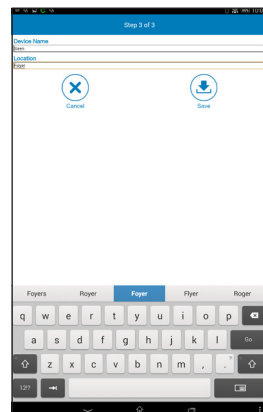

Pairing the Power Switch

Model AHS613 does not include an Power Switch.

- 1 At the Status screen, tap **+**.

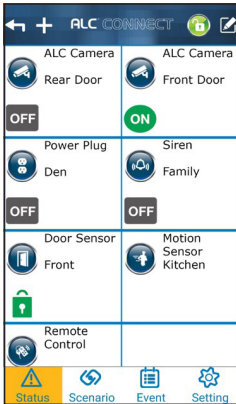

- 2 Tap **Power Plug**.

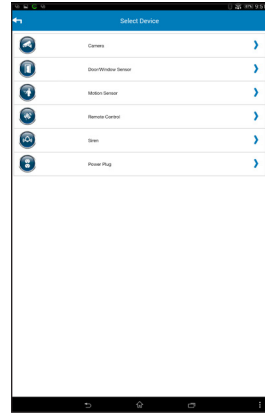

- 3 Tap **Pair** to start the Pairing process. Follow the on screen instructions.

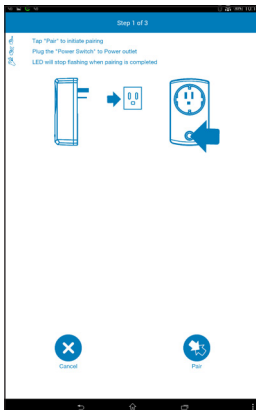

- 4 Plug the Power Switch into a standard AC outlet having 120V, 60Hz; the LED will blink indicating the Power Switch is in the pairing mode.

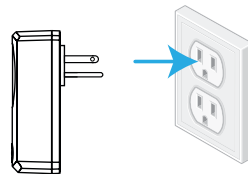

Pairing the Power Switch

5 If the Power Switch did not pair in step 3, manually pair by pressing and holding the AC button until the LED blinks blue.

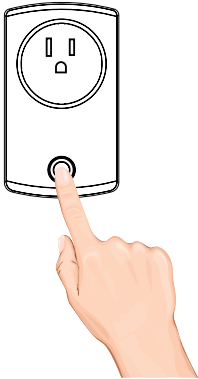

6 The following screen will appear; enter the desired Siren's name and the location.

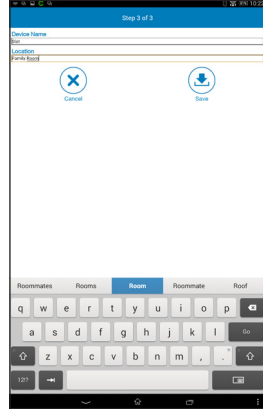

8 Tap **Save**.

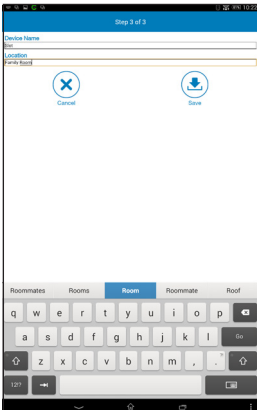

REPEATER:

The power switch can also be used as a 'Repeater'. This function is for advanced users and allows certain devices to be used in further locations. For details, refer to Repeater section on page 45.

Installation Tips

The diagram below shows the suggested location(s) for the security system. Use this as a guide for your installation. The system is expandable with additional compatible wireless cameras, Motion Detectors, door/window contact sensors, sirens or other sensors (see pages 6-8 to see what is included with your kit) for greater protection.

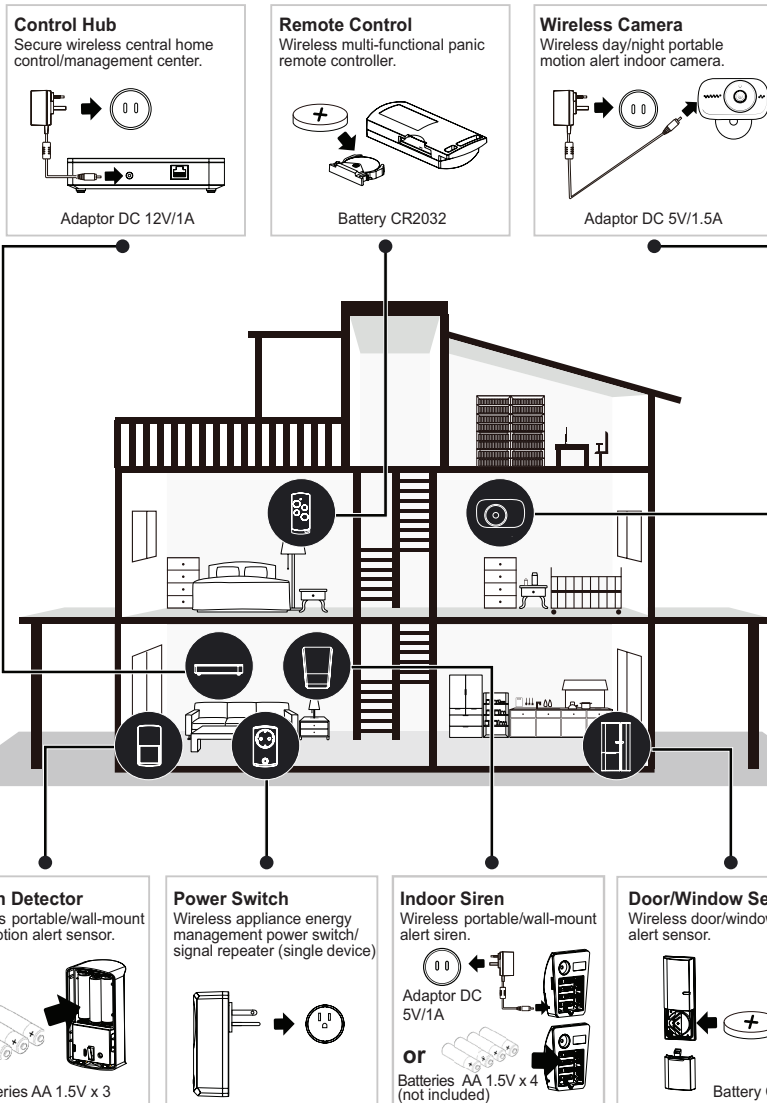

Installation Tips

WARNING:

It is not recommended to use this camera outdoors.

- Before you install the system, plan where and how it will be positioned, and where you will route the cable that connects the camera to the power adaptor(s).
- Avoid having a direct light source in view of the camera.
- Before starting permanent installation, have another person check the camera image on the tablet/phone when camera is positioned in the same place it will be permanently installed.
- If the signal will have to pass through a wall, placing the Wi-Fi router or camera next to a window will improve the signal strength, or utilize the built-in repeater in the Power Switch (see page 45).
- Do not install the camera pointing out of a window. The night-time picture will be unusable due to reflection from the night vision LEDs.
- As dust, grime, and cobwebs accumulate on the camera glass, they can reflect light from the infrared LED and might reduce video quality. Periodically clean the lens glass with a soft cloth.

Night Vision

The camera has built-in infrared LEDs to allow you to view at night for 24-hour surveillance. The LEDs will automatically activate at night and the picture viewed will change to black and white. The night viewing range is up to 15 feet.

Installing the Camera

1 If not mounting, but just using on a flat surface (desk, table, etc.), skip to step 2. Secure the multi-position Camera Bracket to a stable surface, ceiling or wall using the two screws. If needed, two anchors are also included.

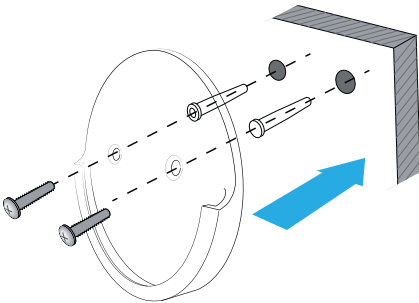

2 Slide the camera into the Camera Bracket if mounting on ceiling or wall. Rotate the camera to the desired viewing angle.

Note: See page 13, step 1 for connecting to AC Power.

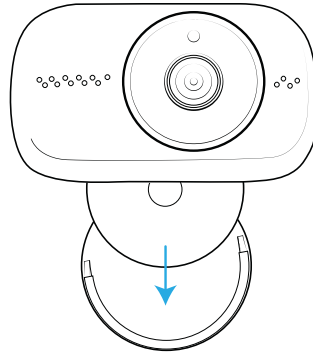

Installing the Door/Window Sensor

Option A - Double-Sided Tape

1 Apply the double-sided tape to the rear of both sections of the Door/Window sensor.

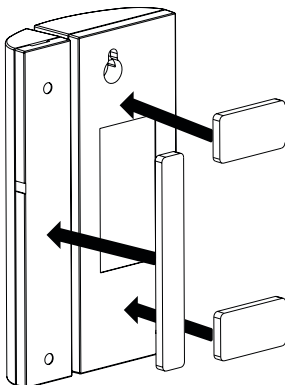

2 Select a location on a door or window. The large section of the sensor should be fixed on the immovable frame of the door/window. Align the small piece to the large one. Fix the small piece on the movable part of the door/window frame.

Notes:

- When it is finished, open the door or window to test if the sensor has been correctly installed. You'll receive an alert from the mobile device if the App and sensor have been correctly installed and paired.
- See page 15 for installing/replacing the battery.

Installing the Door/Window Sensor

Option B - Screws (included)

1 Insert the first mounting screw directly onto the door/window frame (A). Hang the larger section on the mounted screw, remove the battery compartment cover and insert the second screw (B).

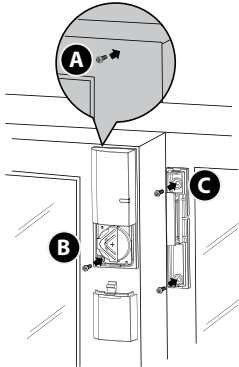

2 Open the back cover of the small section. Use the two mounting screws to fix the back cover onto the movable part of the door/window frame (C - figure in step 1). Insert the sensor onto the back cover.

- Notes:**
- When it is finished, open the door or window to test if the sensor has been correctly installed. You'll receive an alert from the mobile device if the App and sensor have been correctly installed and paired.
 - See page 15 for installing/replacing the battery.

Installing the Motion Detector

Option A - Double-Sided Tape

1 Apply the double-sided tape to the rear of the Motion Detector as shown. Use the thick tape for flat wall mount or the thin tape for corner mounting.

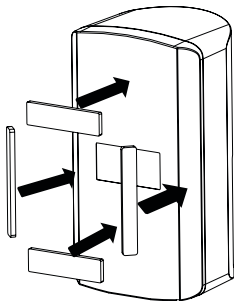

2 Select a desired location. It is recommended to place the Motion Detector in the corner of the room and between 6 to 8 feet from the floor. See notes in step 2 of the top of the next page for installation recommendations.

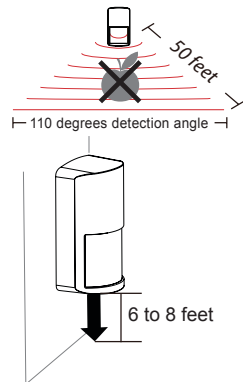

Installing the Motion Detector

Option B - Screws (Corner Bracket and Screws included)

- 1 Flat Wall: Remove back cover and insert the four screws as shown (A).
Corner: Insert the two screws into the corner bracket as shown (B).

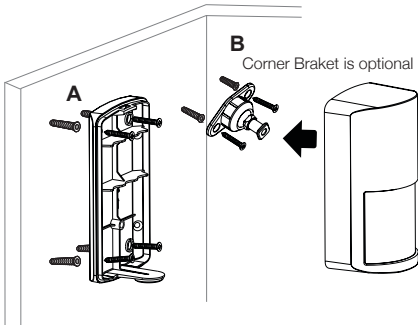

2

Flat Wall: Place the unit back onto the back cover.

Corner: Hang on the corner bracket.

Notes:

- When it is finished, wave hand in front to see if App activates.
- See page 17 for installing/replacing the batteries.
- The Motion Detector is most effective in areas such as hallways and entry points where intruders may likely pass through.
- The Motion Detector monitors movements up to 16 meters away, with 110 degrees detection angle. Make sure it is angled facing with the least obstructions for best coverage.

Installing the Siren

- 1 Remove back cover and insert the three screws as shown. It is recommended to install the siren in a highly visible location with minimum obstacles nearby for maximum visual/sound alert.

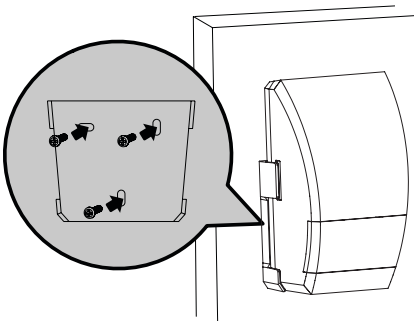

2

Place the unit back onto the bracket.

Notes:

- When it is finished, test to make sure it sounds.
- See page 21 for installing/replacing the batteries or connecting to AC Power.

Basic Operation

1 When first turning on the app you will enter the Control Hub Selection window. Simply tap your Control Hub to enter.



2 The Status screen will then appear; see below and the following pages for the details and operation of the Status page.

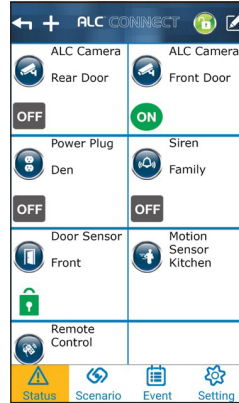

Status Screen Descriptions

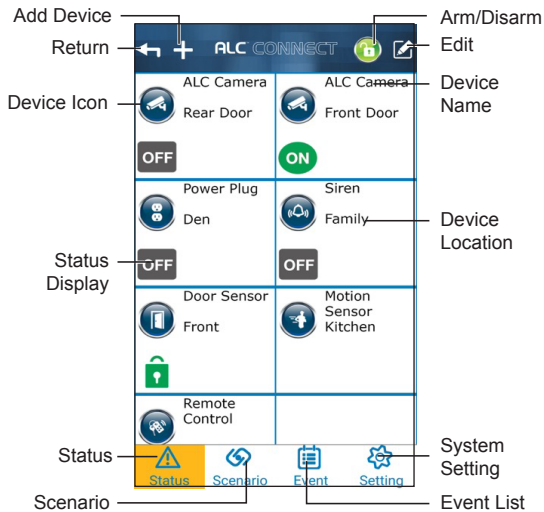

Basic Operation

Status Screen Icon Descriptions

Status Indicator		Door/Window Closed
		Door/Window Open
		Sensor On
		Sensor Off
		Sensor Triggered
		Battery Low
Edit Icon (Appears in Edit Mode)		Delete
		Edit Mode

3 ARM AWAY and ARM STAY: Tap to Arm/Partially disarm the system. Select one of the following options:

Stay: Only arms the Door/Window sensors so you can stay at home.

Away: Arms all devices.

Note: You will hear a beep and a pop-up window with a 30 second countdown appears. Tap Disarm if you accidentally tapped the wrong option, otherwise let the countdown finish.

4 Tap to enter the Edit mode.

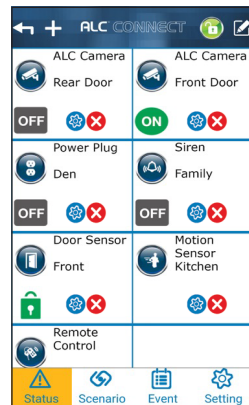
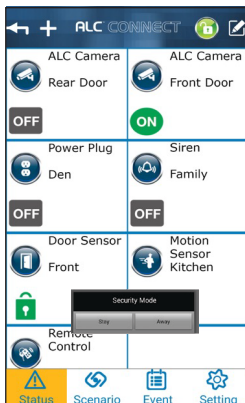

Basic Operation

5 Tap  to enter the respective device's Edit window, which will allow you to set the following:

Siren: Name and Location. You can also set the Siren volume.

Door/Window Sensor: Name and Location. You can also set the Entry Delay Time to 30 seconds before the sensor activates.

Remote Control: Name and Location.

Power Switch: Name and Location. You can also set the Auto Off Time (when set with a scenario).

Motion Detector: Name and Location.

Camera: See the following page.

Tap **X** to delete the device.

6 Tap  next to the Camera to enter the Camera's Edit window, which will allow you to change the Name, DID, Security Code and Location.

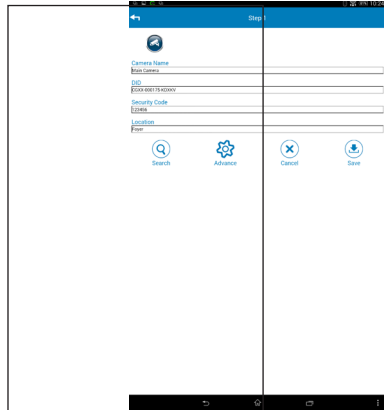

7 At the Camera's Edit window, you can also tap  then enter the Admin Password to enter the Advanced settings as described on the next page.

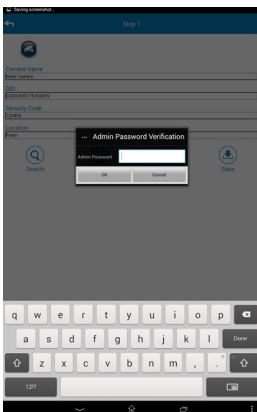

Basic Operation

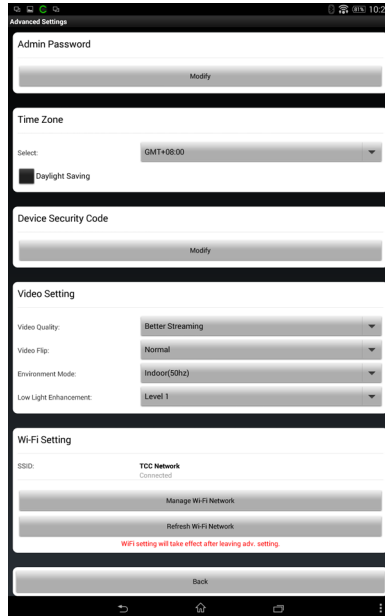

Set the following at the Camera's Advanced Settings:

Admin Password: Tap **Modify** to change the Admin Password.

Time Zone: Tap to select the time zone you are in. Tap the checkbox to select daylight saving time.

Device Security Code: Tap **Modify** to change the Device Security Code.

Video Setting: Tap to set the Video Quality. Tapping **Better Streaming** will allow for faster video streaming, but the picture will not be as clear. Tapping **HD Better** will give the best video but will be slow. Tapping **Better Image or HD Normal** will provide mid speed and mid video picture.

Video Flip: Tap to select the desired screen orientation; Normal, Flip, Mirror or Flip & Mirror.

Environment Mode: Tap to select the frequency used in your area. North America uses 60Hz, European countries use 50Hz, or Outdoor.

Low Light Enhancement: Tap to set the Low Light Enhancement. 5 will provide the brightest enhancement and 1 the lowest.

Wi-Fi Setting: The Wi-Fi setting allows you to choose the home network and setup the Wi-Fi environment, or refresh the Wi-Fi Network.

SSID (Android): This is the network the camera is connected to.

Continued on next page

Basic Operation

Sensitivity Setting: Tap **Detect Mode** to set the desired Sensitivity Settings as follows:

OFF: Turns sensitivity off.

PIR: (Passive Infrared Sensor) is an electronic sensor that measures infrared (IR) light radiating from objects in its field of view.

Software: Uses advanced software to achieve optimal motion sensitivity.

SSID (Android): This is the network the camera is connected to.

Email Setting (only used with Gmail accounts): Tap to set your Gmail account in order to receive email alerts. Fill in the following fields:

Use SSL: Tap the SSL switch to transmit the data with encryption. This setting requires the Simple Mail Transfer Protocol (SMTP) configuration. Most ISPs use the SMTP method to transfer outbound mail via the internet. Only use the SMTP that supports SSL.

SMTP Server: This should be smtp.gmail.com.

SMTP Port: Enter 465.

Username: Enter your Gmail username.

Password: Enter your Gmail password.

Receiver: Enter the email address you want the alerts to go to. (This can be different than the SMTP outgoing email account.)

Memory Card Setting: Tap to erase all data stored in the SD Card.

* Check box if you would like the Memory Card to overwrite data/recordings.

Profile Setting: Saves your existing preferences or loads your previously saved settings.

Device Information: Displays device's Version, Total Space and Free Space.

Device Control

- 1** On the Status window, tap a Device's icon to turn the device on or off, or many various functions as described in this section. The Door/Window Sensor and Motion Detector do not have any control screens.

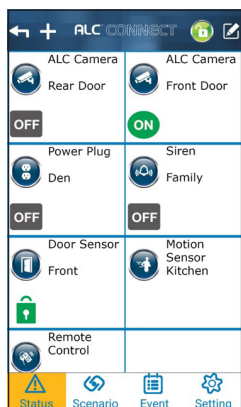

- 2** **Siren:** Tap the Siren icon, then turn the Siren On or Off. Tapping On will sound the Siren.

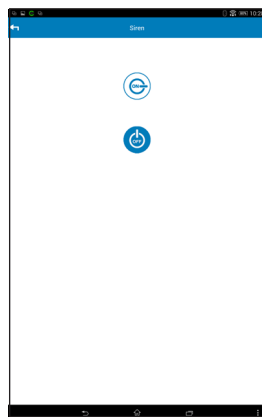

- 3** **Remote Control:** Tap the Remote Control icon and then an icon below to activate the respective function corresponding to the buttons on the remote control. Note that the button operation can be changed (see page 37).

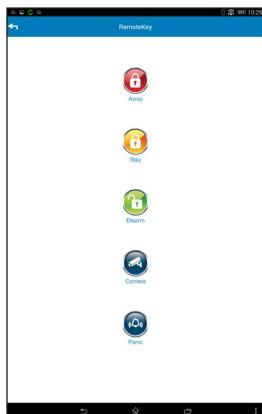

- 4** **Power Switch (Slot):** Tap the Power Switch (Slot) icon, then turn the Power Switch On or Off. Note that when the On option is selected, the LED on the Power Switch will turn off.

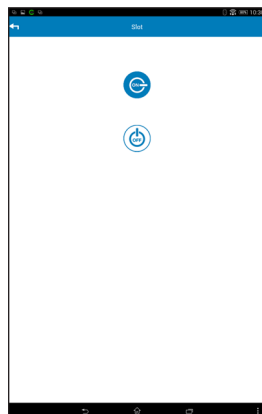

Device Control

Model AHS613 does not include a Camera.

- 1 On the Status window, tap the Camera. At this screen you can view the camera.

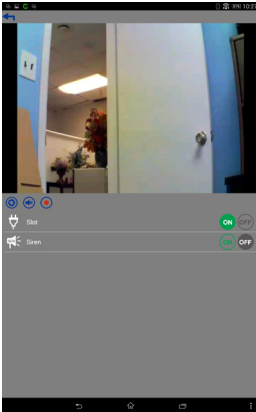

- 2 Tap the icons under the image to perform the following:
 - Snapshot:** Tap to capture screen images. The snapshots will be saved into the camera roll of your mobile device.
 - Mute/Un-mute:** Press to hear the sound of the camera's microphone through the App. Tap again to mute the sound.
 - Record:** Tap to record. Video records for about two minutes. Note that a Micro SD Card (not included) is required to use the recording function on the camera. Insert on the side of the camera.

- 3 **Bottom Icons:** The bottom two icons are used to turn an item On or Off. Shown on this screen are the Power Switch and the Siren devices.

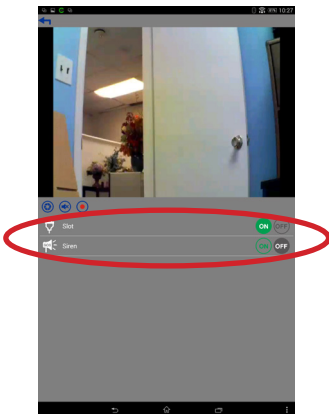

One-Touch Scenario

Both the 'One-Touch Scenario' and the 'Sequence Scenario' are designed so you can customize the functions of the Remote Control buttons and the App controls (to mirror them) to setup items such as activate single/multiple cameras and sensors for recording and alerts, etc.

This allows you to conveniently activate the security function(s) with a single touch when required. The one-touch scenario section has three default controls and they correspond with the buttons on the remote control. You can customize the content of each to fit your needs. After setup, the control buttons on the remote will carry out the same commands as the one-touch scenarios in the app.

First see below for the initial functions of the Remote Control and how the buttons on the remote correspond to the Scenario Window's icons.

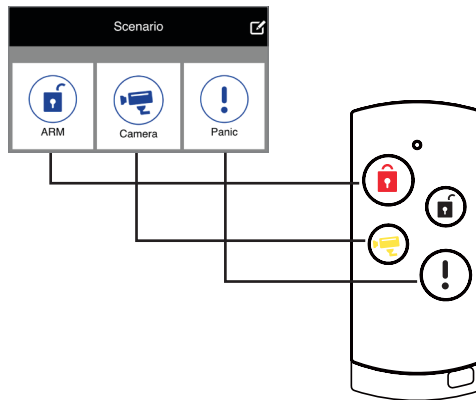

ARM AWAY-ARM STAY: Arm or Partially Arm the preselected camera(s) and sensor(s). Select Disarm to disable system's Arm or Partial Arm status. Only after you have armed the system will you will be able to receive Email/Push Notification (see page 43). You will have 30 seconds to exit the premise after initiating the Arm or Part-Arm function.

RECORD: Activate selected camera(s) for immediate recording.

PANIC: Activate selected camera(s), siren(s) and power switch(es) for emergency recording, alarm sounding and/or Power Switch (lighting) needs.

By default, the devices will appear in the control group list AFTER you have paired them to the control hub box. Please follow the steps on the next page to edit.

One-Touch Scenario

1 Tap the Scenario icon to enter the Scenario screen.

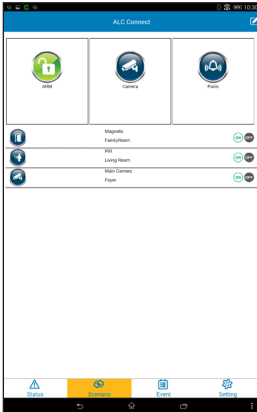

2 Tap  to enter the Edit mode.

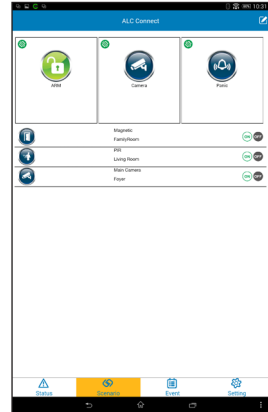

3 Tap one of the three one-touch scenarios you wish to edit.

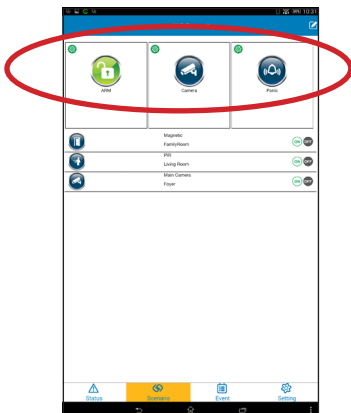

4 You can now rename the one-touch scenario and check the desired device to activate upon pressing/tapping; i.e. on ARM's setup, you can set up the Camera for Arm Away or Arm Stay. Tap **Save** when done.

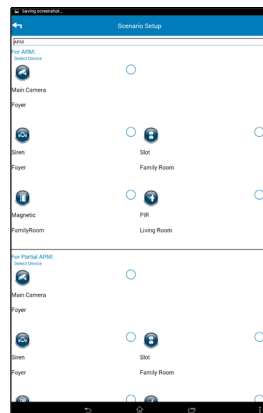

Sequence Scenario

1 Allows you to preset a sequence of events. For example, once the Motion Detector detects motion, the camera can begin recording and the light can turn on. Tap the Scenario icon to enter the Scenario screen.

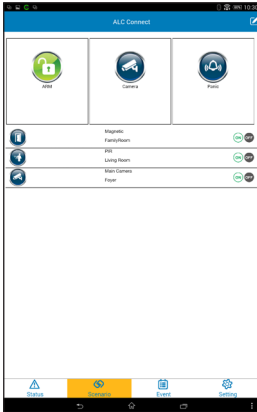

2 Tap one of the Sequence Scenarios.

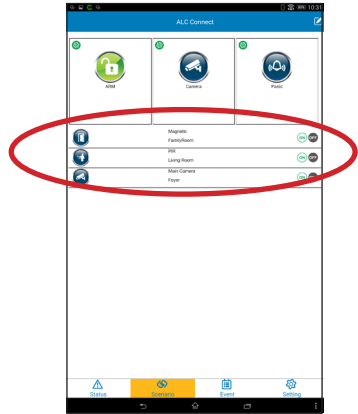

3 You will see a screen with “When...” followed by the main device. You will also see “Then...” which is where you will add items that will activate.

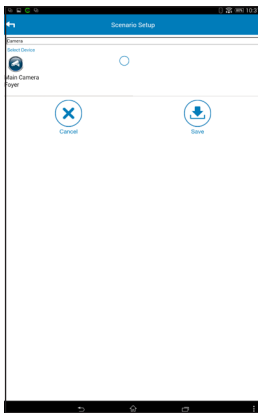

4 Tap +.

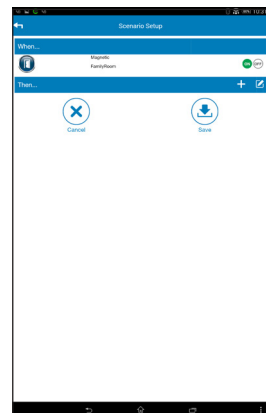

Sequence Scenario

5 Select the desired device to activate by tapping it. Note that adding a device will automatically activate it.

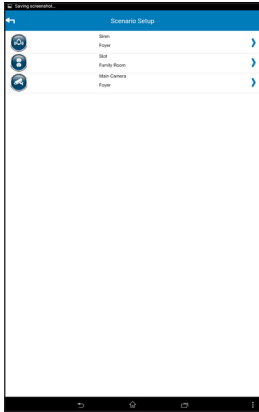

6 Tap **On** or **Off** to set what status the selected device will be set to upon activation. Select **Record** or **View** if the Camera is added.

Repeat steps 4 to 6 until the desired devices have been set.

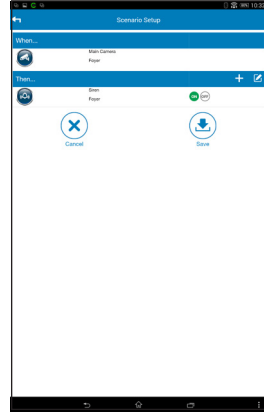

7 To delete a device under “Then...”, tap  to enter the Edit mode and then delete devices as desired. Tap **Save** when done.

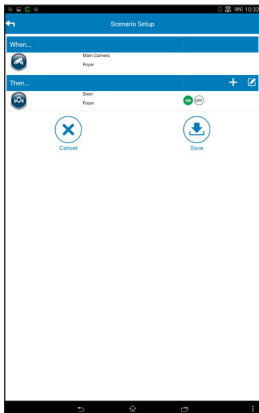

Operation

1 Tap the Event icon to enter the Event screen.

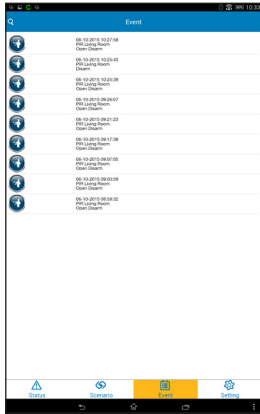

2 The list of triggered events will appear. If a video has been recorded, you can tap it to play it on the mobile device. Use the Play, Pause, Mute, and Unmute buttons during video playback.

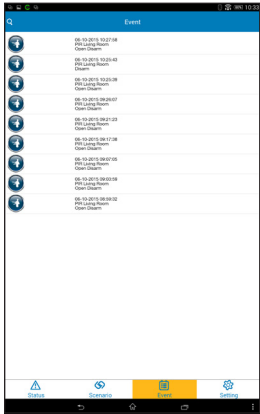

Notes:

- Model AHS613 does not include a Camera. Video viewing is not available if there is no camera connected.
- Video records for one minute when an alert has been triggered.

Operation

1 Tap the Setting icon to enter the Setting screen. Enter the Admin Password (default is 123456). Tap **Confirm** when done.

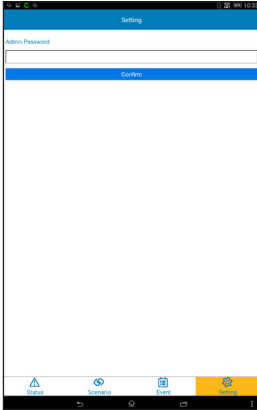

2 The System Setting screen will appear. This section will describe the settings of this screen.

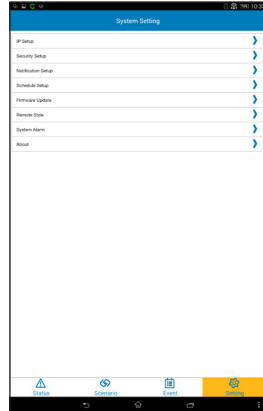

3 Tap **IP Setup**. If DHCP is selected, then the unit will automatically detect the Protocol settings. To manually set, uncheck and enter the options as per your IP. Tap **Save** when done.

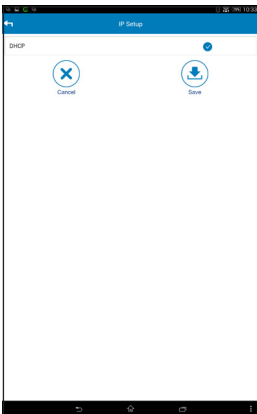

4 Tap **Security Setup**. At this screen you can change the Security Code and Admin Password. You can also enable/disable and set up a PIN Lock for the app once enabled; you will need to enter the PIN Lock code to enter the app. Tap **Save** when done.

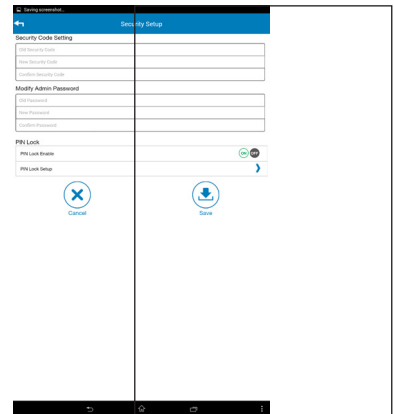

Operation

- 5 Tap **Notification Setup**. At this screen you can disable/enable Email Notifications and/or Push Notifications. Also set an email address to send alerts to. Tap **Save** when done.

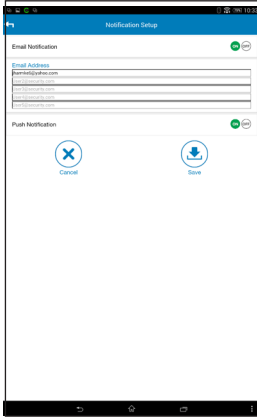

Notes:

- Both Email and Push Notifications are available for System Arm, Disarm and/or trigger events generated from Camera, Motion Detector and Door/Window Sensor selected in the ARM/DISARM scenario section.
- For iOS app, if you turn off the Notification function here you will not receive any push notifications, even when you have turned on the notification function in the notification section of the iOS system setting.

- 6 Tap **Schedule Setup**. At this screen tap on a device, then tap + to begin scheduling the On and Off times of the Power Switch.

Make sure the Control Hub is connected to the internet so the time is set automatically and will activate properly.



- 7 Check the days you want to set, then set the desired start and end times. You can also tap Random to have the Power Switch come on randomly. Tap **Save** when done.

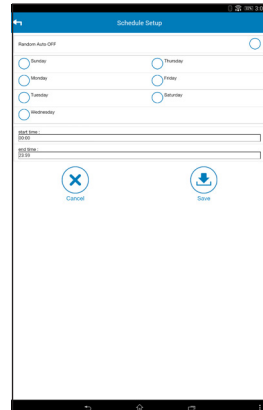

Operation

- 8 Tap **Firmware Update** then tap **Update** to check for firmware updates. If one is available, tap Yes and install the new firmware. The App may restart.

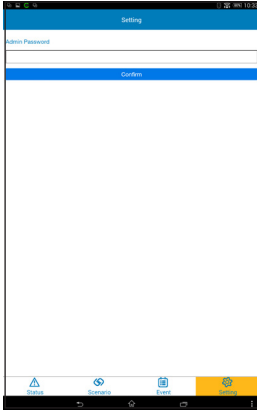

- 9 Tap **Remote Style**. Tap to turn **On** or **Off**. If you turn on, next time you startup the app the screen will only display the Remote Control and Settings. To deactivate, go to Settings and tap **Off** in this option.

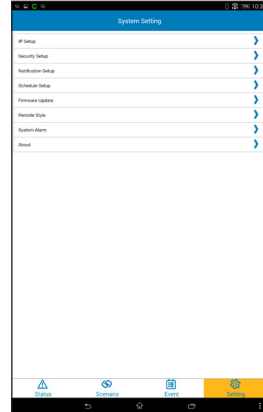

- 10 Tap **System Alarm**. Tap **On** or **Off** to activate or deactivate the Alert & Sounds from the Control Hub Device.

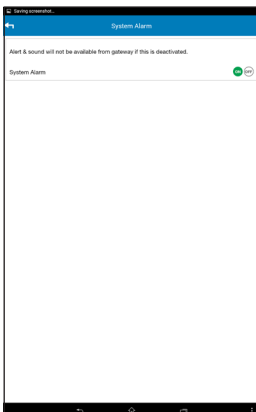

- 11 Tap **About**. At this screen you can view the Firmware Information and App Information.

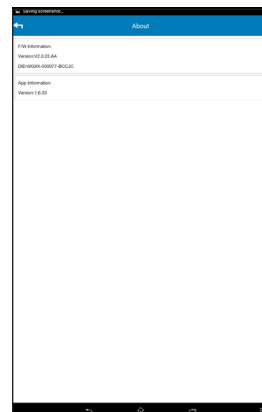

Setup

Model AHS613 does not include a Power Switch.

- 1 Make sure the Power Switch and the Sensor you want to “extend the range” have been successfully paired/connected to the system Control Hub. Press and hold the Power Switch button until the LED begins blinking blue and orange.

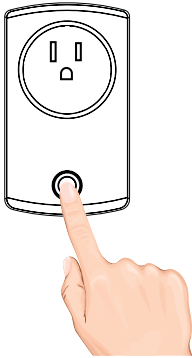

- 2 While the LED is blinking blue and orange, activate the pairing mechanism on the End Sensor (pressing the Pairing button, removing the compartment, etc., see pages 23-24). The LED on the Power Switch will then turn solid orange, indicating the repeater pairing process has been completed.

Note: You will not be able to control the End Sensor if the Power Switch (repeater) is removed. Plug the Power Switch back in to regain the control and communication between control hub and end Sensor.

- 3 **To Deactivate the Repeater Mode:** Unplug the Repeater Power Switch.

- 4 Press and hold the Power Switch button and plug the switch back to the outlet with the button pressed. Do not let go of the button until the LED begins to blink blue. Both the Power Switch and the End Sensor will require pairing with Control Hub again to resume their normal operation.

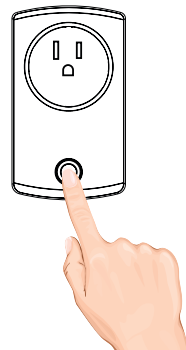

If you have any trouble with your system, try these simple steps which should handle most common issues.

Problem	Possible Solution
Control Hub Device not working.	<p>Make sure it is plugged into an AC Outlet and that the rear connection is inserted correctly.</p> <p>Make sure the Ethernet cable is connected to the rear of the Gateway and to a working router.</p>
A Sensor device is not working.	<p>Make sure fresh batteries are installed according to the diagram in the compartment.</p>
Cannot remotely connect to the Control Hub from a mobile device.	<p>Check the internet status, located above where the Ethernet cable is inserted. The orange LED indicates the network socket is powered on. The green LED indicates the network status. If the Green LED becomes solid green instead of flashing, it means the network has failed.</p> <p>Make sure the router is functioning properly and reconnect the Ethernet cable to the Control Hub.</p>
<p>Poor picture quality.</p> <p>Camera not recording.</p> <p>Email Alert is not working.</p> <p>A white image appears at night (camera).</p>	<p>Clean the camera lens using a microfiber cloth.</p> <p>Ensure the MicroSD card is inserted into the camera.</p> <p>Make sure the email alert function is enabled.</p> <p>Make sure the email address has been correctly entered.</p> <p>The camera's infrared LEDs shine invisible light that reflects off of surfaces such as glass and will cause white light.</p>

Use this and next page for more troubleshooting if any... if not remove and reflow next page.

Factory Default/Reset

Insert a paper clip or similar object into the Reset hole for five seconds and the system will start the reset process. The system will restore to factory default settings and you may start the Wi-Fi setup.

Control Hub

Operation Voltage.....	12V DC/1A
Ethernet.....	10/100 Mbps
Sub-1G	916.8 MHz
LED	Max Standby 8hr

Camera

Wireless Compatible.....	IEEE 802.11 b/g/n
Sensor.....	2 Mega Pixel CMOS
Frequency	2400~2485 MHz
Protocol	TCP/IP, UDP, SMTP, NTP, DHCP, ARP
Image Compression	H.264
Image Resolution.....	HD 1280 x 720
Operating Temperature	-10°~+50° C
Operating Humidity	20~80 RH (N.A.-condensing)
Communication Range.....	500 ft (164 yards) in open space
Current Consumption	500 mA (MAX)
Night Vision	15 ft (4.5 m)
Dimensions.....	3.8 x 3.3 x 3.5 in (96 x 83 x 89 mm)
MicroSD Card Time (4GB)	150 Events (HD/Better)/180 Events (Better Streaming)
MicroSD Card Time (8GB)	300 Events (HD/Better)/360 Events (Better Streaming)
MicroSD Card Time (16GB)	600 Events (HD/Better)/720 Events (Better Streaming)
MicroSD Card Time (32GB)	1,200 Events (HD/Better)/1,440 Events (Better Streaming)

Remote Control

Signal Frequency	916.8 MHz
RF Range (open field conditions)	150 M
Battery Type	1 x CR2032 Battery (included)
Battery Life	Anticipated life up to 2 years (Supposed 10 triggers per day)
Battery Power Monitoring	Yes (On device and transmitted to App)
Operating Temperature	0°~40° C
Operating Humidity	10%~80% RH
Dimensions.....	2.4 x 1.2 x 0.6 in (60 x 30 x 14 mm)

Motion Detector

Signal Frequency	916.8 MHz
RF Range (open field conditions)	150 M
Max. Detection Range	16 M
Detection Angle	110°
Battery Type	3 x 1.5V AA Batteries (included)
Battery Life	Anticipated life up to 2 years (Supposed 200 triggers per day)
Battery Power Monitoring	Yes (On device and transmitted to App)
Tamper Detection	Yes (Rear)
Operating Temperature	0°~40°C
Operating Humidity	10%~80% RH
Dimensions	4.3 x 2.4 x 2.0 in (110 x 61.4 x 51.6 mm)

Power Switch/Repeater

Signal Frequency	916.8 MHz
RF Range (open field conditions)	150 M
Plug Type	USA/EU/UK/FR
Load Switching Capability	EU 3500W/USA 1800W/UK 3000W
Operating Temperature	0°~40°C
Operating Humidity	10%~80% RH
Dimensions	3.7 x 2.2 x 1.2 in (94 x 55 x 31 mm)

Siren

Signal Frequency	916.8 MHz
RF Range (open field conditions)	150 M
Power Source	DC-in 5V/1A (4 x AA batteries as backup power, not included)
Battery Life	Anticipated life up to 2 years (Supposed 10 triggers per day)
Piezo Siren	Maximum 105 dB
Waterproof	IP44
Battery Power Monitoring	Yes (On device and transmitted to App)
Tamper Detection	No
Tamper Switch	No
Operating Environment	Indoor
Operating Temperature	-10°~+50° C
Operating Humidity	10%~80% RH
Dimensions	4.7 x 3.1 x 1.4 in (120 x 80 x 35 mm)

One-Year Limited Warranty

Important: Evidence of original purchase is required for warranty service.

Atoms Labs LLC (“ALC”) ELEMENTS OF WARRANTY: ALC warrants, if properly installed and used thereafter in strict accordance with the use and care guidelines provided in the instructions manual, the Product shall be free from manufacturing defects in material and workmanship for one (1) year from the documented date of purchase. The purchase date must be documented with either an original sales receipt from the first retailer selling the Product or by credit card receipts or statements. The warranty is non-transferrable.

LIMITED WARRANTY: The warranty terminates one year after the date of original retail sale. The warranty is invalid if the Product is (A) damaged or not maintained as reasonable or necessary, (B) modified, altered, or used as part of any conversion kits, subassemblies, or any configurations not sold by ALC, (C) improperly installed, (D) serviced or repaired by someone other than an authorized ALC service center for a defect or malfunction covered by this warranty, (E) used in any conjunction with equipment or parts or as part of any system not manufactured by ALC, or (F) installed or programmed by anyone other than as detailed by the owner’s manual for this product.

THIS WARRANTY DOES NOT COVER DATA LOSS, OR COSTS RELATED TO DATA RECOVERY. ALC MAKES NO WARRANTY THAT ANY SOFTWARE PROVIDED WITH THE PRODUCT WILL FUNCTION WITHOUT INTERRUPTION OR OTHERWISE BE FREE OF ANOMALIES, ERRORS OR VIRUSES. THIS WARRANTY DOES NOT COVER ANY COSTS RELATING TO REMOVAL, REPLACEMENT, OR INSTALLATION OF ANY PRODUCT, REGARDLESS OF WHETHER THE PRODUCT IS FOUND BY ALC TO BE DEFECTIVE, OR SOFTWARE INSTALLED ON THE USER’S COMPUTER.

ALC DOES NOT MAKE ANY CLAIMS OR WARRANTIES OF ANY KIND WHATSOEVER REGARDING THE PRODUCT’S POTENTIAL, ABILITY OR EFFECTIVENESS TO PREVENT, MINIMIZE, OR IN ANY WAY AFFECT PERSONAL OR PROPERTY DAMAGE OR INJURY. ALC IS NOT RESPONSIBLE FOR ANY DAMAGE, LOSS OR THEFT RELATED TO THE PRODUCT OR TO ITS USE FOR ANY HARM, WHETHER PHYSICAL OR MENTAL RELATED THERETO. ANY AND ALL CLAIMS OR STATEMENTS, WHETHER WRITTEN OR VERBAL, BY SALESPEOPLE, RETAILERS, DEALERS OR DISTRIBUTORS TO THE CONTRARY ARE NOT AUTHORIZED BY ALC AND DO NOT AFFECT THIS PROVISION OF THIS WARRANTY. THE LIMITED WARRANTY IS THE SOLE AND ENTIRE WARRANTY PERTAINING TO THE PRODUCT AND IS IN LIEU OF AND EXCLUDES ALL OTHER WARRANTIES OF ANY NATURE WHATSOEVER, WHETHER EXPRESS, IMPLIED OR ARISING BY OPERATION OF LAW, INCLUDING, BUT NOT LIMITED TO ANY IMPLIED WARRANTIES OF MERCHANTABILITY OR FITNESS FOR A PARTICULAR PURPOSE. THIS WARRANTY DOES NOT COVER OR PROVIDE FOR THE REIMBURSEMENT OR PAYMENT OF LOST REVENUE, PROFIT, OR DATA, OR FOR SPECIAL, INDIRECT, CONSEQUENTIAL, INCIDENTAL, OR PUNITIVE DAMAGES HOWEVER CAUSED AND REGARDLESS OF THE THEORY OF LIABILITY. Some states do not allow this exclusion or limitation of incidental or consequential damages so the above limitation or exclusion may not apply to you. Your damages will be limited to the total purchase price you paid for the Product.

Use of audio or video equipment for recording the image of a person without their knowledge and consent is prohibited in certain states or jurisdictions. The end-user assumes all liability for compliance with applicable state, local and federal laws. Atoms Labs has no responsibility or liability for how the end-user uses a product. Wireless cameras require a wired connection to AC power outlet. Network conditions and environmental factors can adversely affect wireless signal range. Actual night vision range and image clarity depends on installation location, viewing area and light reflection / absorption.

This Product may only be sold in the United States of America and Canada. There is no warranty whatsoever on the Product outside of the United States of America and Canada.

STATEMENT OF REMEDY: If the Product is under warranty, ALC will either, at its option, repair or replace the defective Product and return it to you without charge for parts, service, or any other cost. ALC, at its option, may replace the Product with a new or refurbished Product.

LEGAL REMEDIES: This limited warranty gives you specific legal rights, and you may also have other rights which vary from state to state. All parties irrevocably submit themselves to the exclusive venue and personal jurisdiction of the state and federal courts in Denton County, Texas with regard to any dispute relating to this Warranty or its enforcement. The parties also hereby waive any challenge to venue and personal jurisdiction they may have to a lawsuit filed in a state or federal court in Denton County, Texas, regarding a dispute between the parties relating to this Warranty or its enforcement. You agree that Atoms Labs is entitled to its reasonable and necessary attorney’s fees if it is a prevailing party in litigation against you relating to this Warranty. If any provision of this Warranty is found to be invalid, illegal, or unenforceable, the validity, legality, and enforceability of any of the remaining provisions will not in any way be affected or impaired and a valid, legal, and enforceable provision of similar intent and economic impact will be substituted therefore.

PROCEDURE FOR OBTAINING PERFORMANCE OF WARRANTY: If, after following the instructions in the owner’s manual you are certain that the Product is defective, pack the Product carefully (preferably in its original packaging). The Product should include all parts & accessories originally packaged with the Product. Include evidence of original purchase & a note describing the defect that has caused you to return it. The Product should be shipped freight prepaid, by traceable means, to warrantor at:

Atoms labs LLC
2670 Firewheel Drive Suite D
Flower Mound, TX 75028
844-767-8544

9 a.m. to 6 p.m., Central Time, Monday through Friday

ALC reserves the right to make changes to its products without incurring any obligation to modify any product that has already been manufactured. This warranty does not cover any alteration or damage to any other software that may be or may become resident on the users system as a result of installing any software provided.

ALC appreciates your support and feedback! If you come across software bugs or ways we could improve our products, we would love to hear about them! Please email us at support@ALCWireless.com and you will hear back from us.

©2014 Atoms Labs LLC. All rights reserved. iPhone, iPad, iPod Touch, and App Store are registered trademarks of Apple, Inc. Chrome and Android are registered trademarks of Google, Inc. Certain other product names, brand names, and company names may be trademarks or designations of their respective owners.

Use of audio or video equipment for recording the image of a person without their knowledge and consent is prohibited in certain states or jurisdictions. The end-user assumes all liability for compliance with applicable state, local and federal laws. Wireless cameras require a wired connection to AC power outlet. Network conditions and environmental factors can adversely affect wireless signal range. Actual night vision range and image clarity depends on installation location, viewing area and light reflection / absorption. Lithium-ion battery must be recycled or disposed of properly. Lithium-ion battery must be recycled or disposed of properly. Photography and illustration may differ slightly from actual product.



FCC Compliance Statement: This device complies with Part 15 of the FCC rules. Operation is subjected to the following two conditions: (1) this device may not cause harmful interference, and (2) this device must accept any interference received, including interference that may cause undesired operation.



Products with CE Marking comply with EMC Directive (2004/108/EC); Low Voltage Directive (73/23/EEC); R&TTE (1999/5/EC); ROHS Directive (2011/65/EU) issued by the Commission of the European Community. Compliance with these directives implies conformity to the following European Norms: EMC: EN 301 489 LVD: EN 60950 Radio: EN 300 328

If the camera system no longer functions or can no longer be repaired, it must be disposed of according to the valid statutory regulations. Disposal of spent batteries/accumulators:



You are required by law (Battery Ordinance) to return all spent batteries and accumulators. Disposing of spent batteries/accumulators with common household waste is prohibited! Batteries/accumulators that contain hazardous substances are marked with the symbols on the side. These symbols indicate that it is prohibited to dispose of these batteries/accumulators in the household waste. The abbreviations for the respective heavy metals are: Cd=cadmium, Hg=mercury, Pb=lead. You can return spent batteries and accumulators that can no longer be charged to the designated collection points in your community, outlets or wherever batteries or accumulators are sold. Following these instructions will allow you to fulfill the legal requirements and contribute to the protection of our environment!

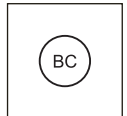



ALC™

Wireless Made Simple.

ALCWireless.com