



# N-GEN

## CITUS 시리즈

사용설명서 &  
조립설명서

차원이 다른 게이밍 의자를 경험해보세요!

### 구성품

누락/파손된 구성품이 있을 경우 당사 고객센터로 문의 바랍니다. 070-4411-9061

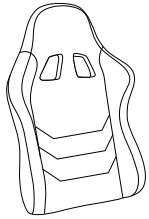

등판 X1

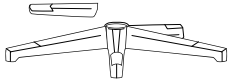

베이스 X1  
베이스 다리 X1



금속 플레이트 X1



중심봉 X1

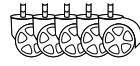

바퀴 X5

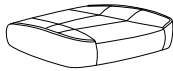

좌판 X1



팔걸이 X2

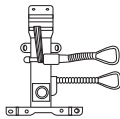

락킹 X1



발받침대  
쿠션 X1



육각 렌치 X1

추후 지속적인 관리를 위해  
육각 렌치를 버리지 말아주세요.

### 조립 부품



락킹  
볼트 X4



플레이트 -  
락킹 볼트 X3



팔걸이  
볼트 X4



플레이트 -  
등판 볼트 X4



볼트 마개 X4



발받침대  
볼트 X4

### 의자 용품



헤드 쿠션 X1



등받이 쿠션 X1

## STEP 1. 베이스

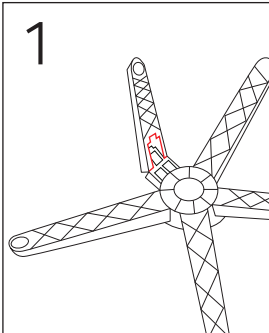
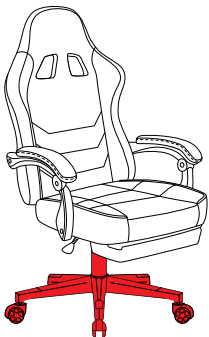

베이스 다리를 베이스에  
세로로 끼워 넣어주세요.

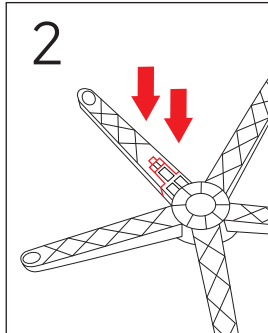

딸깍 소리가 날 때까지  
눌러서 조립해주세요.



**주의!** 손이 틀 사이로 끼지 않도록  
주의해주세요.

베이스를 뒤집어서 힘을 주어  
눌러서 조립해주세요.

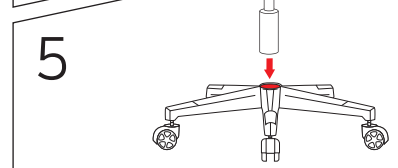
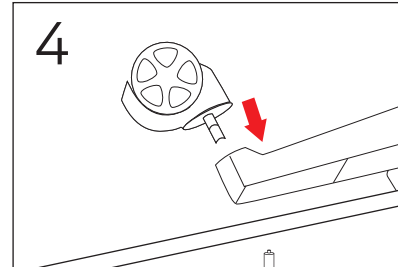

# 주의사항 ☆☆☆

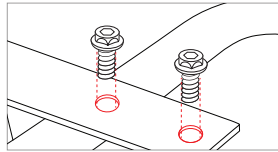

1 볼트 구멍이 정렬되어 있어야 합니다.

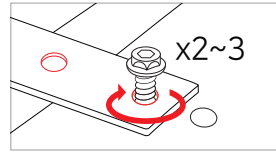

2 처음엔 반만 조립해주세요.

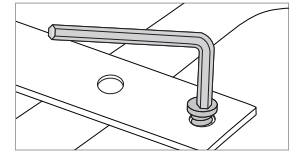

3 이후에 꼭 조여서 조립해주세요.

## STEP 2. 좌판 + 폼레스트

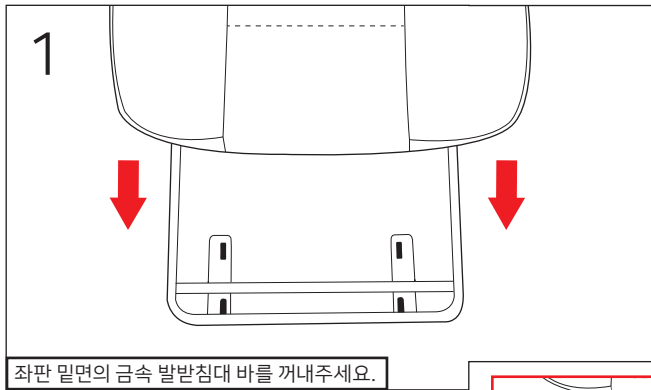
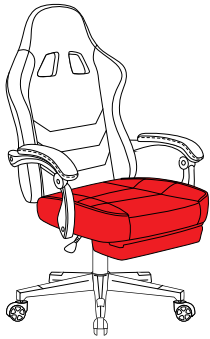

좌판 밑면의 금속 발받침대 바를 꺼내주세요.

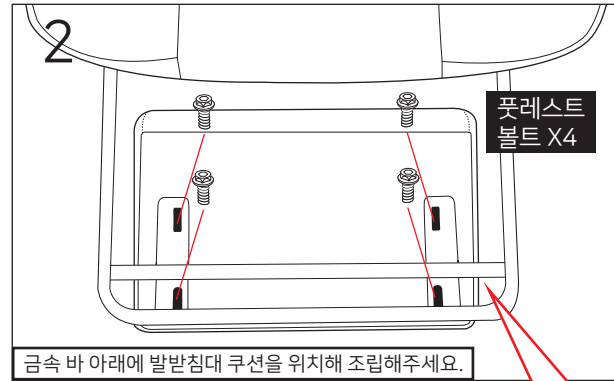

금속 바 아래에 발받침대 쿠션을 위치해 조립해주세요.

### 느슨하게 덜 조여진 볼트 주의!

볼트가 느슨하게 덜 조여진 것처럼 보이면, 팔걸이를 분리하여 바로 볼트 구멍에 삽입을 시도해보세요.

\* 전동 드릴은 제품을 파손 시킬 수 있습니다.  
수동으로 볼트를 조여주세요.

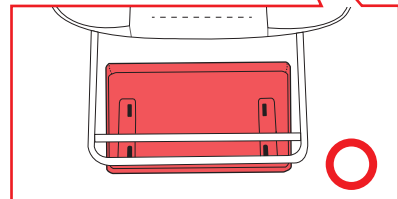
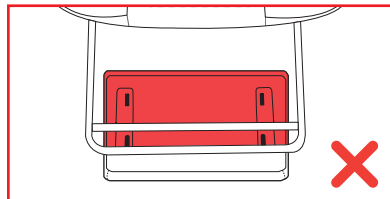

**주의** : 발받침대 쿠션이 직사각형 모양의 금속 바 내부에 위치하도록 유의해주세요.

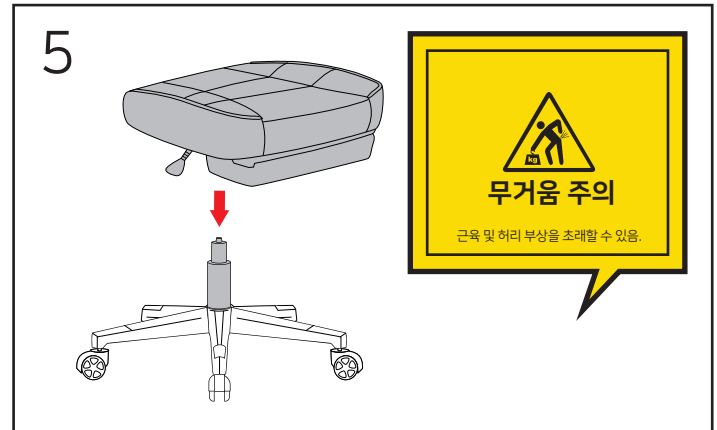
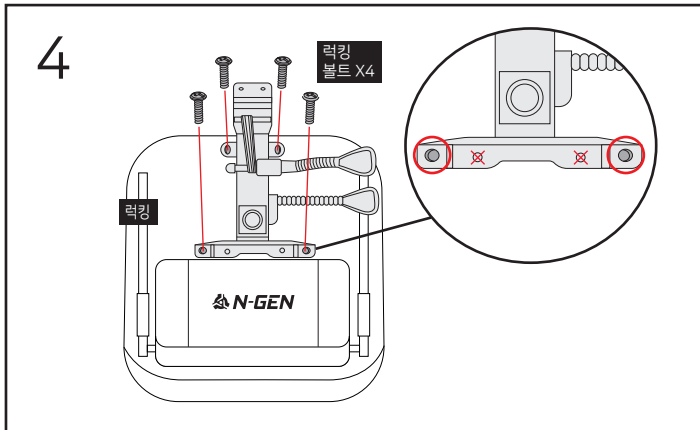
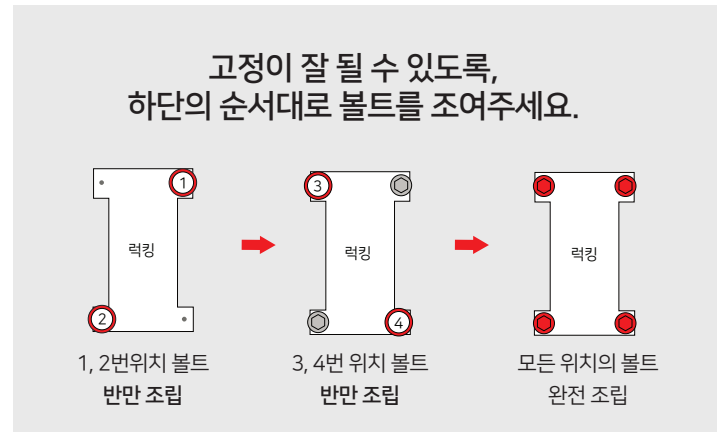
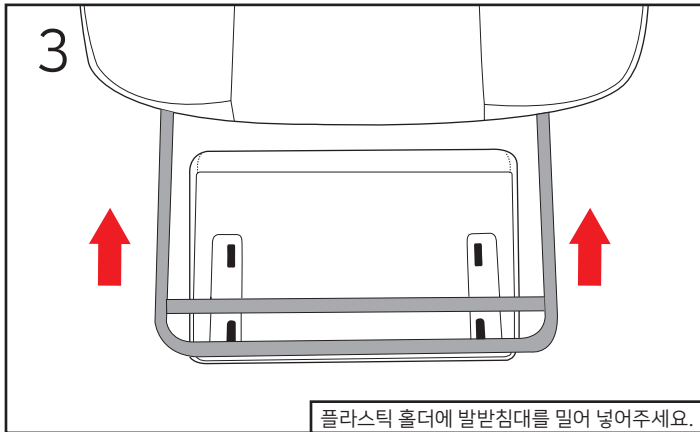

STEP 3. 등판, 팔걸이

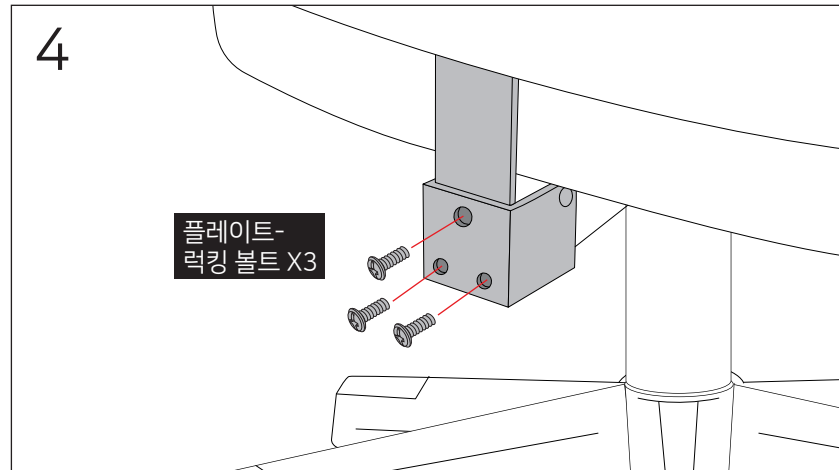
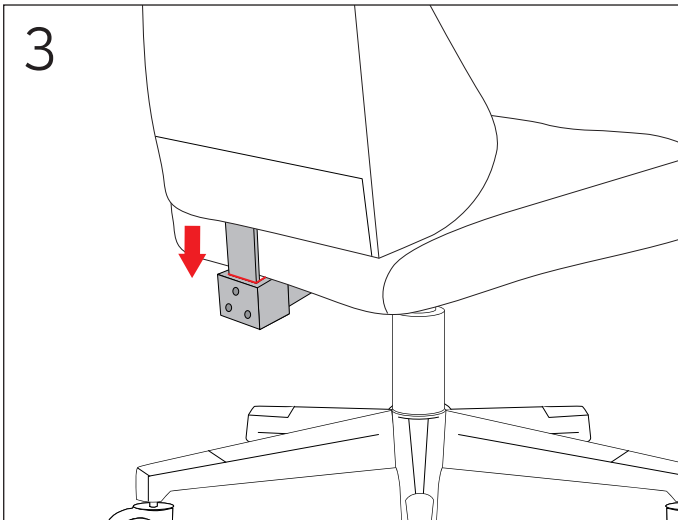
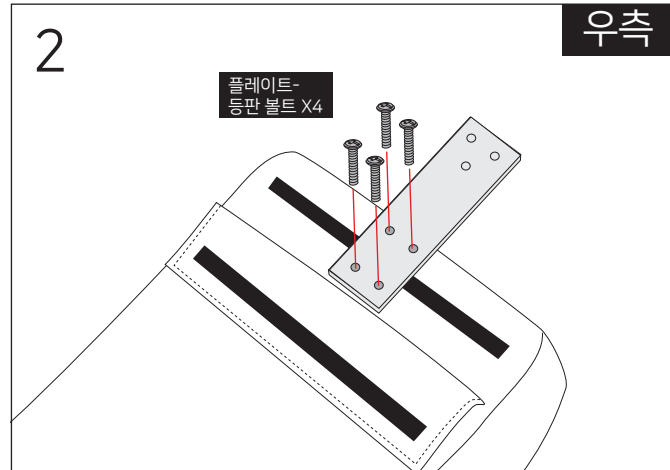
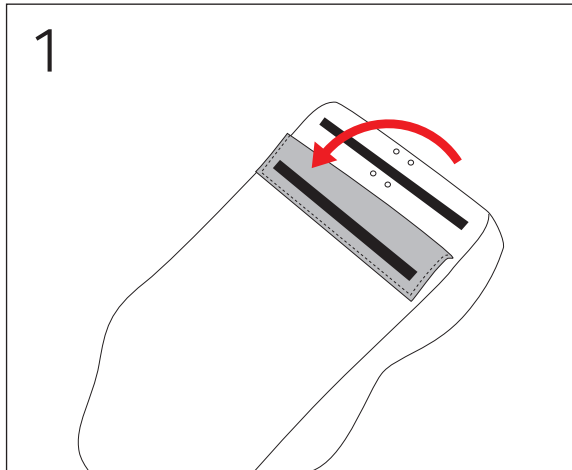

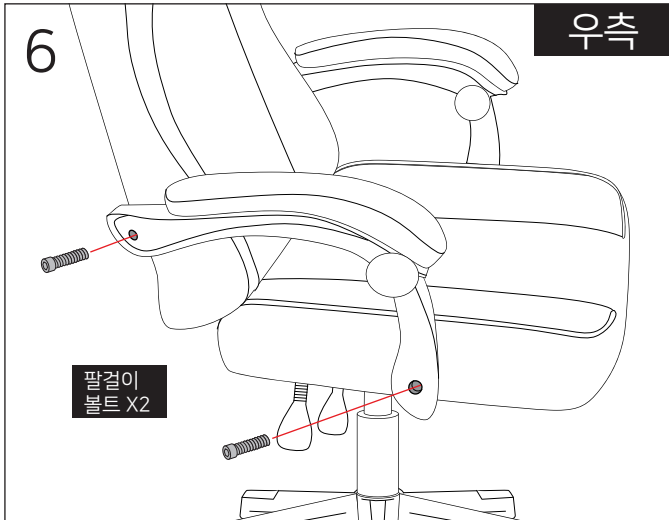
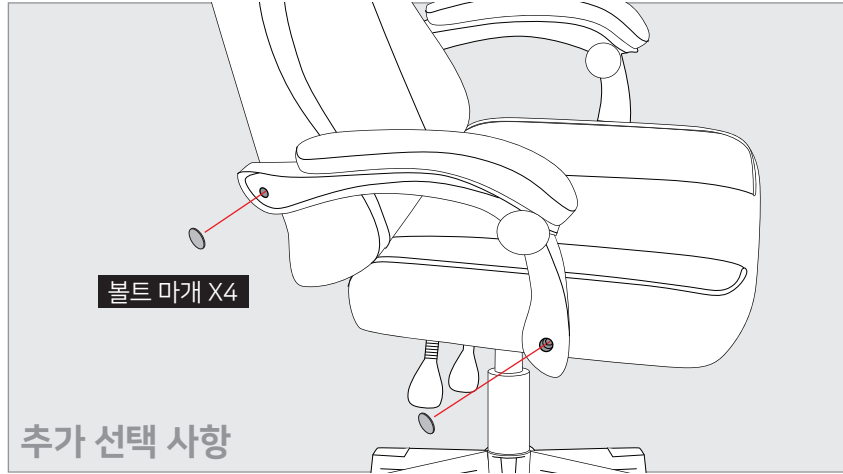
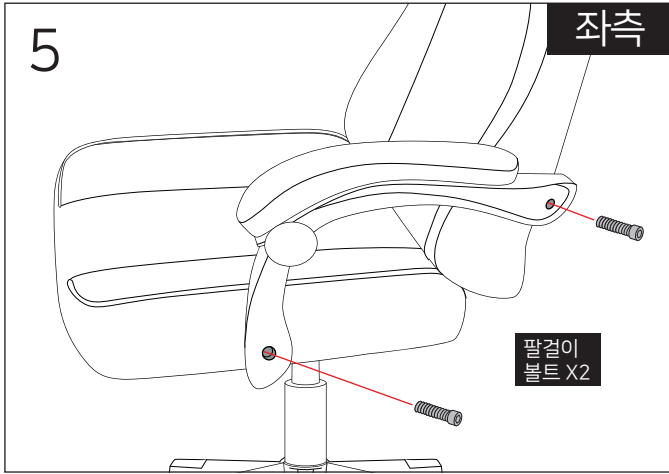

- 전기용품 및 생활용품 안전관리법에 의한 품질표시**
- |  |   |
|--|---|
| <ol style="list-style-type: none"> <li>1. 품명 : 네오체어 CITUS 가족 게이밍 의자</li> <li>2. 외형치수(mm)             <ol style="list-style-type: none"> <li>a. 제품 크기 : W 670mm x L 610mm x H 1230-1350mm</li> <li>b. 좌면의 높이 : 460-570mm</li> </ol> </li> <li>3. 마감재 : 합성가죽</li> <li>4. 구조부재 : 강재, 합판</li> <li>5. 표면가공 : 전기도금 (나일론, 플라스틱 지정 외 표면가공)</li> <li>6. 쿠션재 : 우레탄폼</li> <li>7. 제조연월 : 박스 별도 표기</li> <li>8. 제조자명 : 네오체어 주식회사 OEM</li> <li>9. 수입자명(수입품에 한함) : 네오체어 주식회사</li> <li>10. 주소 및 전화번호 : 경기도 고양시 일산동구 정발산로24, 3층 제티2-304호 ☎ 070-4411-9061</li> <li>11. 제조국명 : 중국</li> </ol> | <ol style="list-style-type: none"> <li>12. 취급상의 주의사항             <ol style="list-style-type: none"> <li>a. 의자는 한번에 1인만 사용하십시오.</li> <li>b. 모든 구성품과 볼트가 결합되지 않은 경우, 의자를 사용하지 마십시오.</li> <li>c. 일부 구성품과 볼트가 누락/빠손 되었을 경우, 의자를 사용하지 마십시오.</li> <li>d. 의자 위에 올라서는 행위 등 의자 본래의 목적 이외에 사용하지 마십시오.</li> <li>e. 의자를 탈탈시에는 양아서 조작하십시오.</li> <li>f. 의자 위에서 떨어지지 않도록 주의하십시오.</li> <li>g. 일부 구성품이 무겁거나 날카로우 수 있으니 주의 하십시오.</li> <li>h. 주기적으로 모든 볼트 제대로 결합되어 있는지 확인하십시오.</li> <li>i. 주의사항을 지키지 않을 시, 심각한 부상을 초래 할 수 있습니다.</li> <li>j. 제품의 모서리에 부딪히지 않도록 주의하십시오.</li> <li>k. 건조하고 서늘한 곳에 제품을 보관하십시오.</li> <li>l. 제품 이동 시, 주의하여 이동하십시오.</li> </ol> </li> </ol> |
|--|---|

**의자 확인**



**접이식 발받침대**

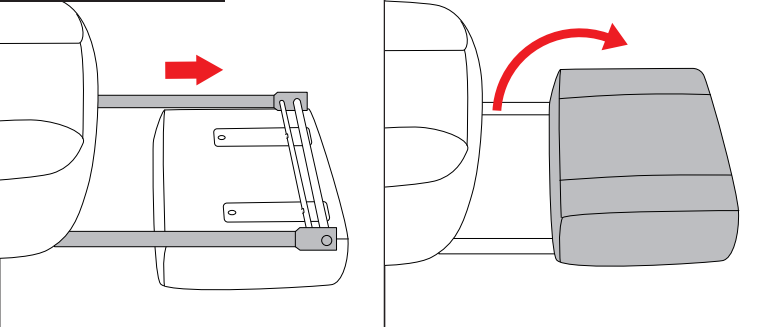

**주의!**



의자에서 일어날 때, 팔걸이를 강하게 누르지 마십시오. 제품이 파손될 수 있습니다.

**리클라이닝**

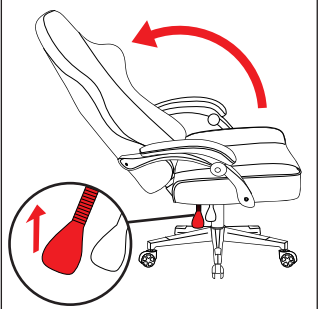

**틸팅 잠금**

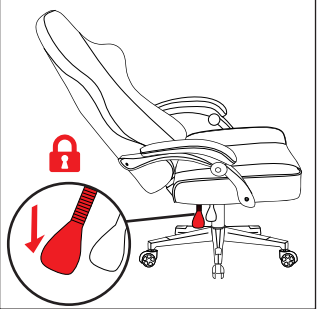

**높이 조절**

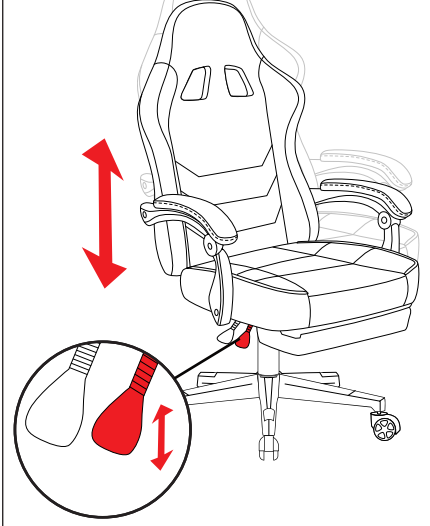

**팔걸이**

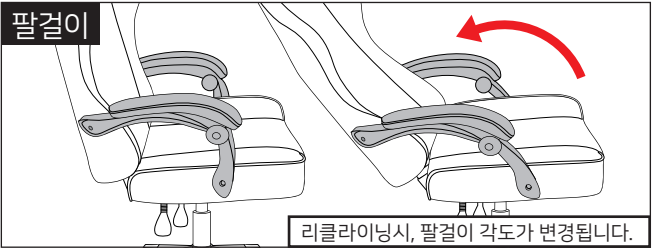

**헤드 쿠션, 등받이 쿠션**

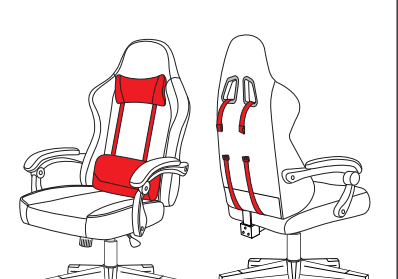



 neo chair  
WWW.NEOCHAIR.CO.KR