



# N-GEN

## *APEX Series*

### USER GUIDE & ASSEMBLY INSTRUCTIONS

# ***Thank you for choosing us!***

N-GEN, Next Generation, is Neo Chair's premium gaming chair brand targeting a higher level gaming chair than any other brands.

When pronounced, N-GEN is similar to the word engine [ˈendʒɪn]. Like the engine to a car, N-GEN gaming chair is the most important part for gamers who sit in the chair for a long time.

N-GEN's model names are inspired by the Latin words for "speed".

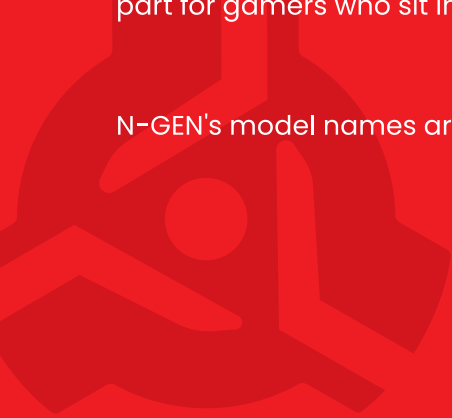

# IT'S TIME TO UPGRADE YOUR CHAIR!

## CHAIR PARTS

If you see any missing part, please contact [support@neochair.com](mailto:support@neochair.com)



BACK x 1



CENTRAL BASE x 1

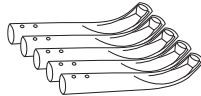

BASE x 5



GAS LIFT x 1

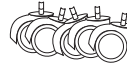

WHEEL x 5



SEAT x 1

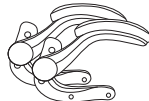

ARMREST x 2

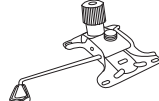

CONTROL MECHANISM x 1

## HARDWARE



ARMREST BOLT X 8



TILTING BOLT X 4



BASE BOLT X 10



BOLT CAP X 8



ALLEN KEY x 1

We recommend keeping your **Allen key** for future maintenance.

## STEP 1. BASE

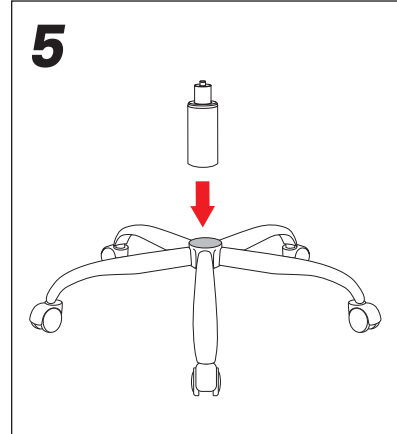
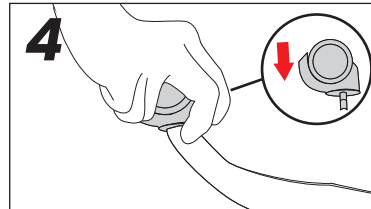
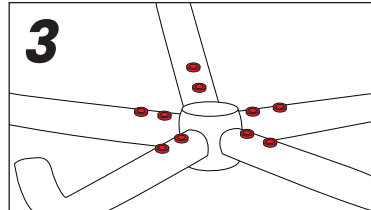
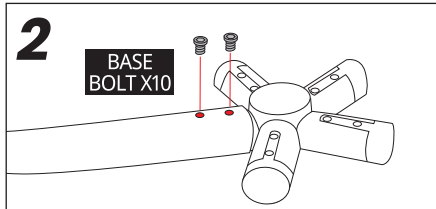
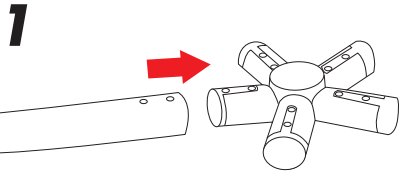

## STEP 2. BODY



# 1

TILTING BOLTS X4

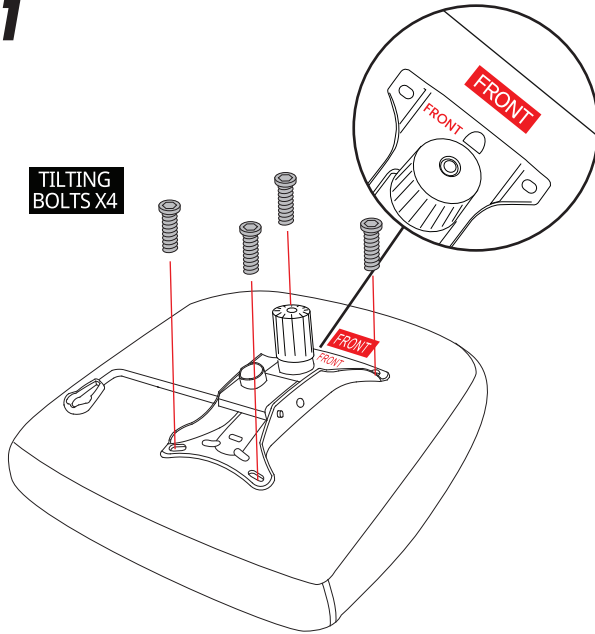

# 2

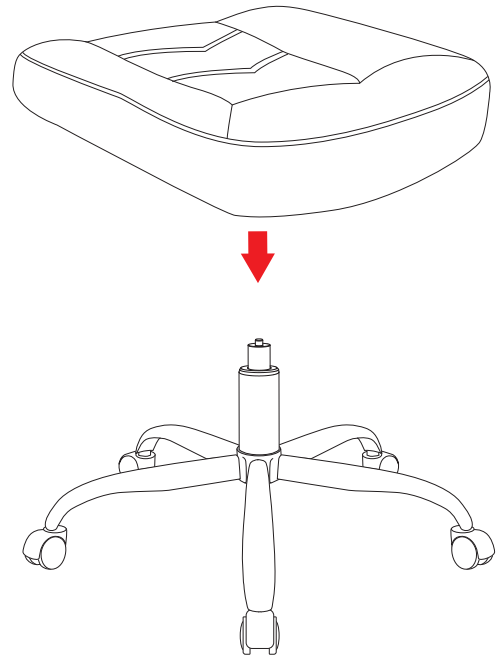

### TILTING ASSEMBLY SEQUENCE

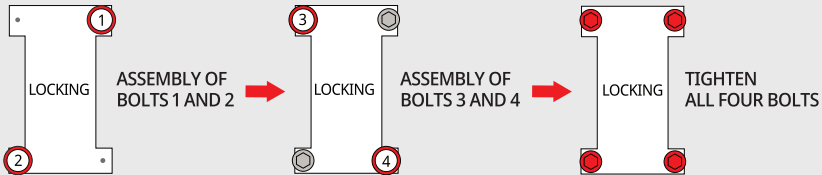

## IMPORTANT NOTICE

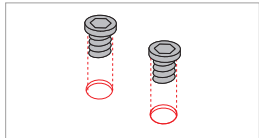

**1** THE BOLT HOLES SHOULD BE ALIGNED

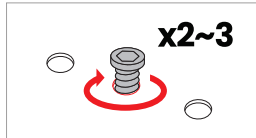

**2** UNDER-TIGHTEN THE BOLTS

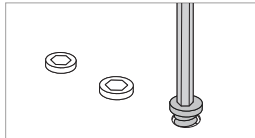

**3** TIGHTEN ALL BOLTS

## LOOSE BOLT ALERT!

When the bolts seem loose, detach the armrests and try inserting the bolts directly into their holes.

\*Using an electric drill can damage the chair. Please re-tighten bolts manually.

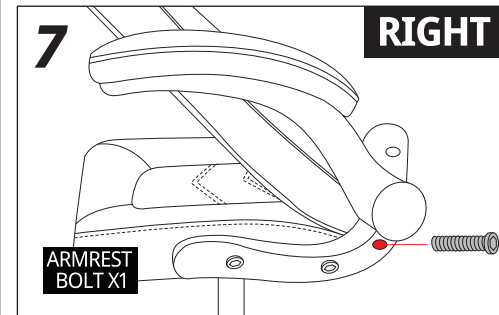
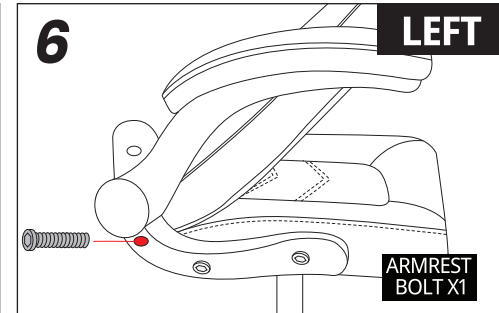
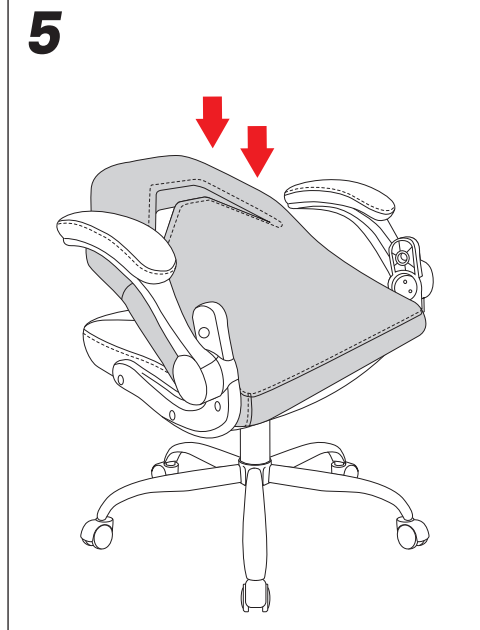
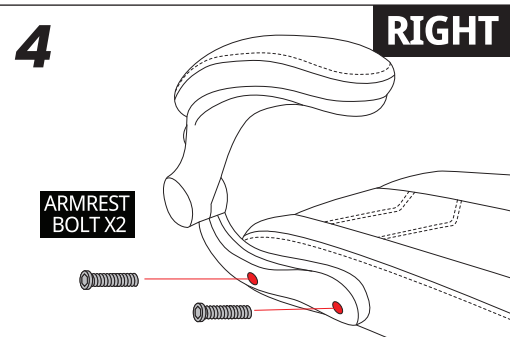
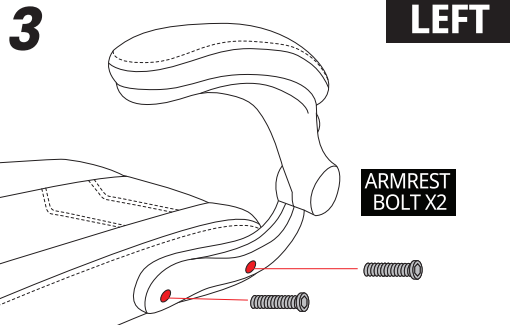

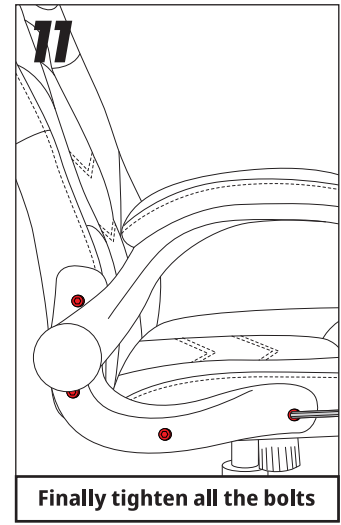
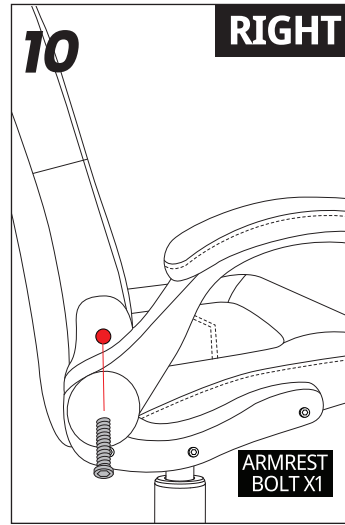
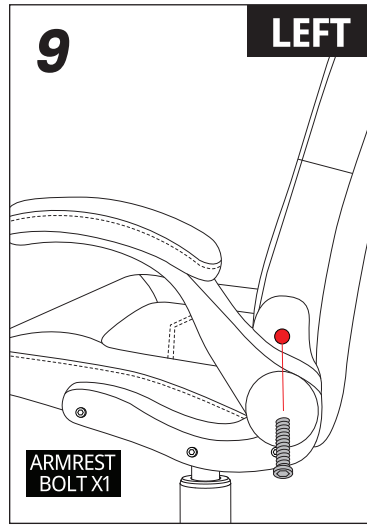
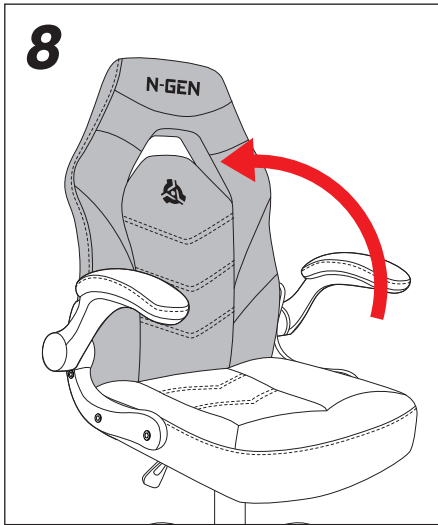

## SAFETY INFORMATION



This product is designed for **one person** to sit at a time.



**DO NOT** use the chair unless all bolts, screws and knobs are tight

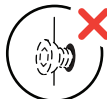

**DO NOT** use the chair if any of the components is missing or damaged.



**DO NOT** stand on the chair as a step stool or a ladder.



**DO NOT** tilt the chair forward, left, or right while sitting.



Be careful **NOT TO FALL** off from the chair.



Be careful, as some parts may be **sharp and heavy**.



Regularly check and tighten all bolts, screws, and knobs.



Failure to follow these warnings may cause **serious injuries**.



Be careful **not to hit** the furniture edges.



Keep in a **dry and cool** place.



When **moving** the object, proceed with **caution**.

## OPTIONAL

**BOLT CAP X8**

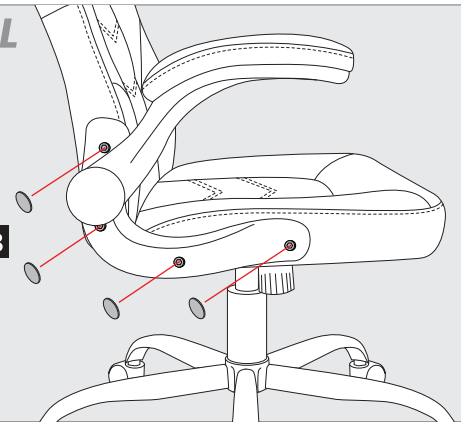

**CHECK!!**

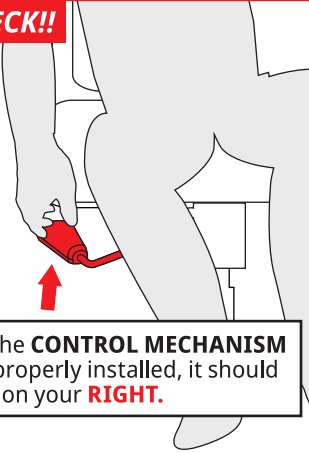

If the **CONTROL MECHANISM** is properly installed, it should be on your **RIGHT**.

**HEIGHT ADJUSTMENT**

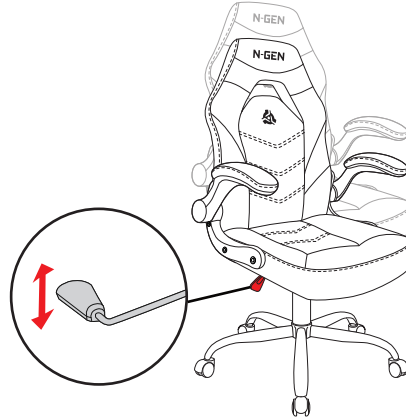

**ADJUSTABLE FLIP-UP ARMRESTS**

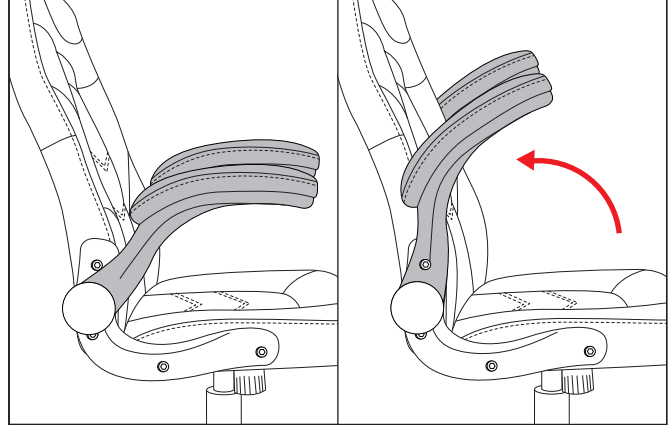

**TILTING TENSION CONTROL**

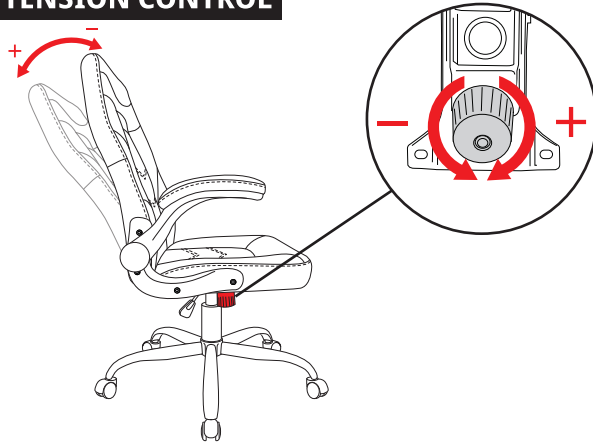

**TILTING LOCK**

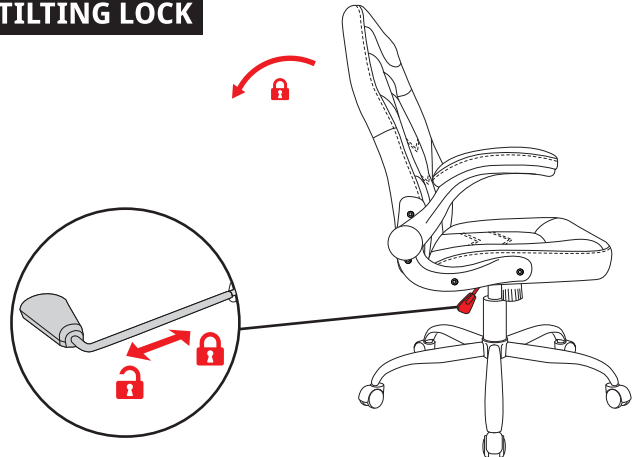



 neo chair  
WWW.NEOCHAIR.COM