

HAUSLANE | chef^{SERIES}

INSTRUCTION, USE & CARE MANUAL

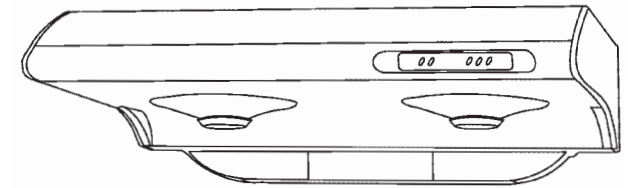

UC-C190SS-30 | UC-C395SS-30 | UC-C395SS_36

READ AND SAVE THESE INSTRUCTIONS



FOR DOMESTIC COOKING ONLY



INSTALLER: Leave this manual with the homeowner.
HOMEOWNER: Use and Care information on Page

WARNING

SUITABLE FOR USE IN HOUSEHOLD COOKING AREA.

TO REDUCE THE RISK OF FIRE, ELECTRICAL SHOCK, OR INJURY TO PERSONS, OBSERVE THE FOLLOWING:

- Use this unit only in the manner intended by the manufacturer. If you have the questions, contact the manufacturer at the email address or telephone number listed in the warranty.
- Before servicing or cleaning unit, switching power off at service panel and lock service panel to prevent power from being switched on accidentally. When the service disconnecting means cannot be locked, securely fasten a prominent warning device, such as a tag, to the service panel.
- Installation work and electrical wiring must be done by a qualified personnel in accordance with all applicable codes and standards, including fire-rated construction codes and standards.
- Sufficient air is needed for proper combustion and exhausting of gases through the flue (chimney) of fuel burning equipment to prevent back-drafting. Follow the heating equipment manufacturer's guidelines and safety standards such as those published by the National Fire Protection Association (NFPA), and the American Society for Heating, Refrigeration and Air Conditioning Engineers (ASHRAE), and the local code authorities.
- When cutting or drilling into wall or ceiling, do not damage electrical wiring and other hidden utilities.
- Ducted fans must always be vented to the outdoors.
- Do not use this unit with any solid-state speed control device.
- To reduce the risk of fire, use only steel ductwork.
- This unit must be grounded.

TO REDUCE THE RISK OF A RANGE TOP GREASE FIRE:

- Never leave surface units unattended at high settings. Boilovers cause smoking and greasy spillovers that may ignite. Heat oils slowly on low or medium settings.
- Always turn hood ON when cooking at high heat or when cooking flaming foods.
- Clean ventilating fans frequently. Grease should not be allowed to accumulate on fan or filter.
- Use proper pan size. Always use cookware appropriate for the size of the surface element.

WARNING

TO REDUCE THE RISK OF INJURY TO PERSONS IN THE EVENT OF A RANGE TOP GREASE FIRE, OBSERVE THE FOLLOWING*:

- SMOTHER FLAMES with a close-fitting lid, cookie sheet or metal tray, then turn off the burner. BE CAREFUL TO PREVENT BURNS. IF THE FLAMES DO NOT GO OUT IMMEDIATELY, EVACUATE AND CALL THE FIRE DEPARTMENT.
- NEVER PICK UP A FLAMING PAN – You may be burned.
- DO NOT USE WATER, including wet dishcloths or towels – This could cause a violent steam explosion.
- Use an extinguisher ONLY if:
 - You own a Class ABC extinguisher and you know how to operate it.
 - The fire is small and contained in the area where it started.
 - The fire department has been called.
 - You can fight the fire with your back to an exit.

*Based on "Kitchen Fire Safety Tips" published by NFPA.

CAUTION

- For general ventilating use only. Do not use to exhaust hazardous or explosive materials and vapors.
- To avoid motor bearing damage and noisy and/or unbalanced impellers, keep drywall spray, construction dust, etc. off power unit.
- For the best capture of cooking impurities, your range hood should be mounted so that the top of the hood is 27"-30" above the cooking surface. The minimum hood distance above electric cooktop must not be less than 27" and 29" from gas cooktop; any installation less than 27" may cause over heat and cause damage to the range hood, Hauslane does not warrant this improper installation.
- Two installers are recommended because of the larger size and weight of this hood.
- To reduce the risk of fire and to properly exhaust air, be sure to duct air outside – Do not exhaust air into spaces within walls and ceiling or into attics, crawl space or garages.
- Because of the high exhausting capacity of this hood, you should make sure enough air is entering the house to replace exhausted air by opening a window close to or in the kitchen.
- Use with approved cord-connection kit only.
- Please read specification label in product for further information and requirements.

INSTALL DUCTWORK

VENTING REQUIREMENTS

Determine which venting method is best for your application. Ductwork can extend either through the wall or the roof.

A straight, short duct run will allow the hood to perform most efficiently. Long duct runs, elbows, and transitions will reduce the performance of the hood. Use as few of them as possible. Larger ducting may be required for best performance with longer duct runs. The length of the ductwork and the number of elbows should be kept to a minimum to provide efficient performance.

The size of the ductwork should be uniform. Do not install two elbows together. Use 2" duct tape to seal all joints in the ductwork system.

Install a roof or wall cap. Connect round metal ductwork to cap and work back towards hood location.

Use caulking to seal exterior wall or floor opening around the cap.

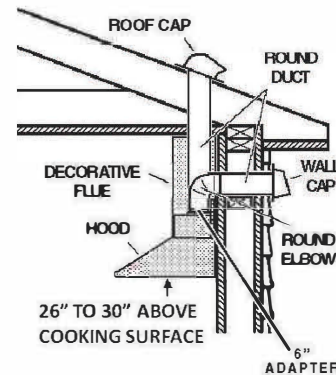

Flexible ductwork is not recommended. Flexible ductwork creates back pressure and air turbulence that greatly reduces performance. **USE ONLY METAL DUCTWORK.** Make sure there is proper clearance within the wall or floor for exhaust duct before making cutouts. Do not cut a joist or stud unless absolutely necessary. If a joist or stud must

45° Elbow	3.0 feet
90° Elbow	5.0 feet
90° Flat Elbow	12.0 feet
Wall Cap	0.0 feet

FIGURE 2

9 feet straight duct	9.0 feet
2 - 90° Elbows	10.0 feet
Wall cap	0.0 feet
Total feet	19.0 feet

FIGURE 3

be cut, then a supporting frame must be constructed.

CALCULATE THE DUCT RUN LENGTH

The duct run should not exceed 35 equivalent feet if ducted with the required minimum of 6" round duct. Calculate the length of the ductwork by adding the equivalent feet in FIGURE 2 for each piece of duct in the system. An example shown in FIGURE 3.

For the best results, do not use more than three 90° elbows in a system. Make sure that there is a minimum of 24" of straight duct between elbows if more than one is used. DO NOT install two elbows together. If you must elbow right away, do it as far away from the hood's exhaust opening as possible. Distances over 30" are at the installer and users discretion.

Cold Weather Installations

An additional back draft damper should be installed to minimize backward cold air flow and a nonmetallic thermal break should be installed to minimize conduction of outside temperatures as part of the vent system. The damper should be on the cold air side of the thermal break. The break should be as close as possible to where the vent system enters the heated portion of the house.

WARNING

- Venting system **MUST** terminate outside the home.
- DO NOT terminate the ductwork in an attic or other enclosed space.
- DO NOT use 4" laundry-type wall caps.
- Flexible-type ductwork is not recommended.
- DO NOT obstruct the flow of combustion and ventilation air.
- Failure to follow venting requirements may result in a fire.
- Indoor installation **ONLY**.
- Contact TATSUMAKI to troubleshoot range hood. DO NOT try to repair yourself, otherwise warranty will be voided.

ELECTRICAL REQUIREMENTS

Before installation and usage, read all the instructions and make sure that the voltage (V) and the frequency (Hz) indicated on the identification plate (found inside your range hood) and all the data inside the appliance are exactly the same as the voltage and frequency in your home.

Note: The manufacturer declines all responsibility in the event of failure to observe all the accident-prevention regulations in force which are necessary for normal use and regular operation of the electric system.

This appliance must be grounded.

This appliance is equipped with a grounding plug cord, the plug must be plugged into an outlet that is properly installed and grounded.

Set the electrical power supply within the space covered by the decorative flues. Position the power socket at a maximum distance of 30" from where the lead exits from the hood. Make sure this does not interface with the bracket fastening area or with the decorative flue (where the flue attached to the wall).

Fit the plug into the power socket. Hard wire connection is not recommended.

WARNING

- Electrical ground is required on this range hood.
- If cold water pipe is interrupted by plastic, non-metallic gaskets or other materials, DO NOT use for grounding.
- DO NOT ground to a gas pipe.
- DO NOT have a fuse in the neutral or grounding circuit. A fuse in the neutral or grounding circuit could result in electrical shock.
- Check with a qualified electrician if you are in doubt as to whether the range hood is properly grounded.
- DO NOT use this appliance with any solid state fan speed control device.
- DO NOT use an extension cord. If the power supply cord is too short, hire a qualified electrician to install an outlet near the appliance.

A 120 volt, 60 Hz AC-only electrical supply is required on a separate 15 amp fused circuit. A time-delay fuse or circuit breaker is recommended. The fuse must be sized per local codes in accordance with the electrical rating of this unit as specified on the serial/rating plate located inside the unit near the field wiring compartment. THIS UNIT MUST BE CONNECTED WITH COPPER WIRE ONLY. Wire sizes must conform to the requirements of the National Electrical Code, ANSI/NFPA 70 – latest edi-

tion, and all local codes and ordinances. Wire size and connections must conform with the rating of the appliance. Copies of the standard listed above may be obtained from:

National Fire Protection Association
Battery March Park
Quincy, Massachusetts 02269

For residential use only.

This appliance should be connected directly to the fused disconnect (or circuit breaker) through flexible, armored or nonmetallic sheathes copper cable. Allow some slack in the cable so the appliance can be removed if servicing is ever necessary. A UL Listed, 1/2" conduit connector must be provided at each end of the power supply cable (at the appliance and at the junction box)

When making the electrical connection, cut a 1-1/4" hole in the wall. A hole cut through wood must be sanded until smooth. A hole through metal must have a grommet.

WARNING - TO REDUCE THE RISK OF FIRE OR ELECTRIC SHOCK, do not use this fan with any solid-state speed control device.

WARNING - TO REDUCE THE RISK OF FIRE, ELECTRICAL SHOCK, OR INJURY TO PERSONS, OBSERVE THE FOLLOWING: Use this unit only in the manner intended by the manufacturer. If you have any questions, contact the manufacturer..

Before servicing or cleaning unit, switch power off at service panel and lock the service disconnecting means to prevent power from being switched on accidentally. When the service disconnecting means cannot be locked, securely fasten a prominent warning device, such as a tag, to the service panel.

When cutting or drilling into wall or ceiling, do not damage electrical wiring and other hidden utilities.

CAUTION: For General Ventilating Use Only. DO NOT use to exhaust hazardous or explosive materials and vapors.

WARNING - TO REDUCE THE RISK OF FIRE, ELECTRICAL SHOCK, OR INJURY TO PERSONS, OBSERVE THE FOLLOWING: Installation work and electrical wiring must be done by qualified person(s) in accordance with all applicable codes and standards, including fire-rating construction.

PLAN THE INSTALLATION

The hood should be mounted to the bottom of a standard wall cabinet. If the hood must be mounted directly to the wall, secure the hood to wall studs.

The hood is connected to a 110-120V AC lighting circuit (15 amp) in the circuit breaker or fuse box.

- Ductwork can be installed vertically or horizontally.
- Duct runs should be as short as possible.
- Avoid the use of elbows.
- Use duct tape at all joints.
- Do not use duct smaller than the discharge on the hood.

NOTE: If the bottom of the cabinet is recessed, attached wood strips (not included), as shown beside, in order to properly install the range under the cabinet. The wood strips must be as thick as recess.

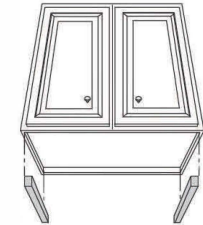

LOCATION PREPARATION

1. Use the dimensional drawings below to lay out the range hood's mounting holes, wiring access and ductwork by marking the cabinet bottom and drywall where applicable.
2. Make cutouts for wiring and ductwork.
3. Install the ductwork so that it is flush to the range hood's mounting surface.
4. Run two-conductor wire (with ground) from a power source to the hood location. Bring approximately 1/2" of wiring through wiring hole.
5. Drill four 3/32" diameter pilot holes at points where mounting holes are marked in cabinet bottom.
6. Insert (4) mounting screws, leaving approximately 1/4" of thread exposed.

Ducting Options (adapters included)

Option 1 

6" round duct Vertical Discharge

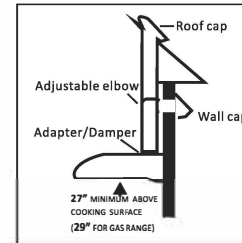

Option 2 

3-1/4" x 10" duct Vertical Discharge

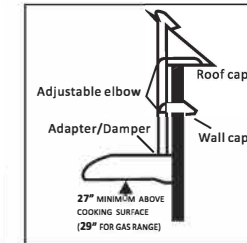

Option 3 

3-1/4" x 10" duct Horizontal Discharge

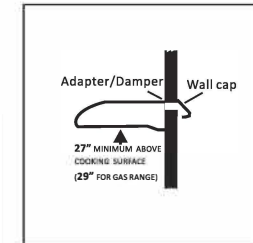

Note: We recommend to install the hood at a minimum 27" from an electric range and at 29" from a gas range. For optimal performance, the hood should not be installed more than 32" from cooking surface.



Please read the manual before installation. I identifies an instruction which, if not followed, might cause serious personal injuries including possibility of death. Denotes an instruction which, if not followed, may severely damage the unit and/or its components; warranty will be void.

Select Your Ducting Option

Option

1

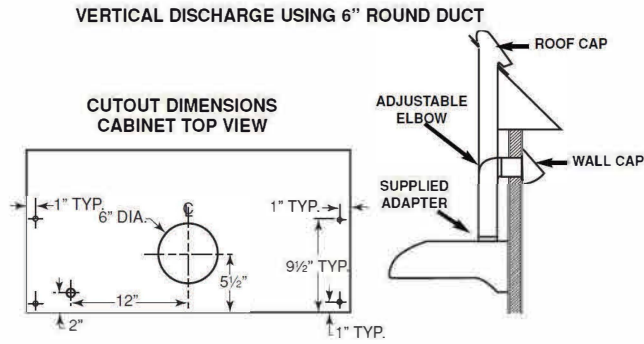

VERTICAL DISCHARGE USING 3 1/4" X 10" DUCT

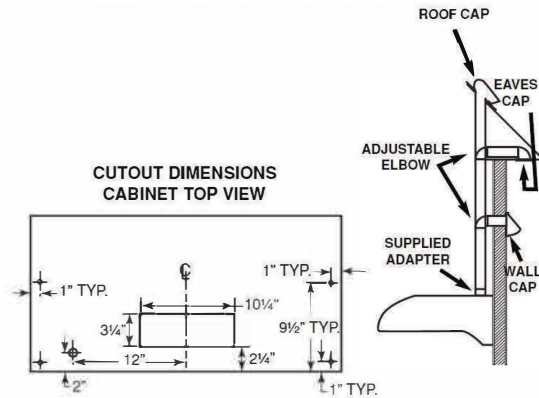

Option

2

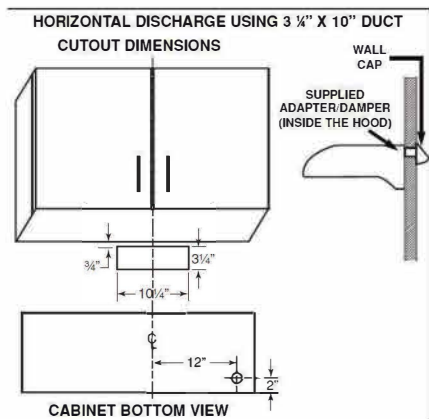

Option

3

Step 1 - Hood Preparation



1. Remove the bottom panel of the hood by removing its (5) mounting screws and set aside.



2. Unplug the small white connector inside the hood.

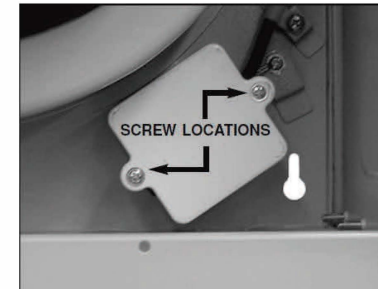

3. Remove the (2) screws retaining the electrical box cover and set aside. Punch out the wiring knock-out located on the TOP of the unit and install an approved wire clamp (not included).

Step 2 - Select Your Ducting Option

Option 1—vertical discharge 6" round duct installation

6" round duct installation (Fig. A) on the top of the hood, using 10 screws (adapter pre-installed at factory)

Fig. A

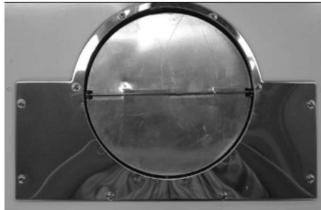

Option 2—vertical discharge 3-1/4" x 10" duct installation

Mount the 3-1/4" x 10" adapter (Fig. B) on the top of the hood, using 10 screws

Fig. B

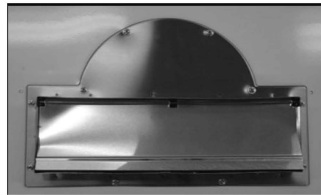

Option 3— horizontal discharge 3-1/4" x 10" duct installation

Mount the 3-1/4" x 10" adapter on the BACK of the hood.

1. Remove the adapter (Fig. A) on the top of the hood.
2. Replace with the shutoff plate (Fig. C)
3. Remove and discard rectangular shutoff plate (Fig. D) located on the back of the hood.
4. Remove and discard the small shutoff plate (Fig. E) located INSIDE the back of the hood. **DO NOT remove the gasket!**
5. Install the adapter with 10 screws previous removed at step 4.

Fig. C



Fig. D



Fig. E

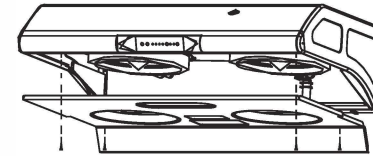

Fig. F



Step 3 - Preparing The Range Hood

1. Unpacking and check the contents. Test the range hood to check all the function is normal before you installation. Remove wiring cover screw and lift off cover (Fig.1)



2. Remove the top or the rear electrical knockout, bring power cord to the range hood (through the cabinet) (Fig.2)

KEYHOLE
SLOTS

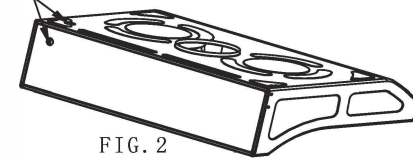

3. Insert a screwdriver into the knockout slot and bend the knockout back and forth (FIG.3-1). You may have to use pliers to pull the loosened knockout free (FIG.3-2)

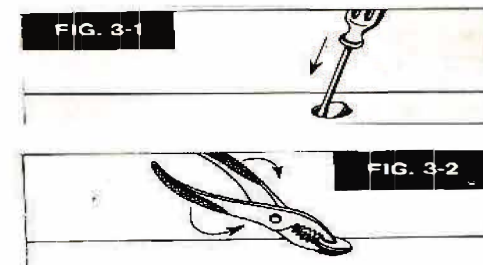

Step 4 - Prepare the Installation Location

If you move the range hood to make room for working on the cabinet, turn off the power for the electric range at the service entrance. Before moving a gas range, shut off the gas.

For installation onto a recessed bottom cabinet:

- Measure the space (under cabinet) between the inside front edge and inside back edge (FIG.4). With a saber saw cut two 1x2" wood filler strips (purchased separately) to fill in the bottom of the cabinet.

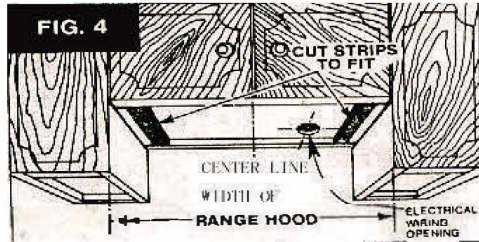

Providing Electrical Power

After turning off the proper 120volt circuit at the service entrance, drill out the electrical power line access hole marked on the cabinet bottom or wall (use a 1 1/4" wood bit). To operate the electric drill, use an extension cord connected to another circuit (FIG.5).

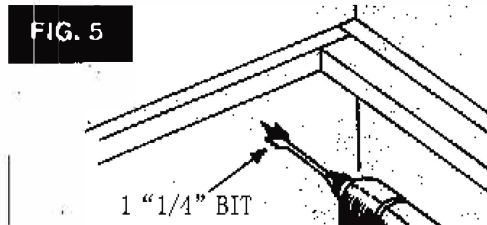

SAFETY WARNING

If drilling into the walls, be careful not to cut existing electrical cables, which would create a hazard. All electrical connections must be in accordance with local codes, decrees or national electrical codes. If you are unfamiliar with methods of installing electrical wiring, secure the services with a qualified electrician.

- Fish the electrical power line through the access hole drilled in the wall or bottom of the cabinet. Attach an appropriate connector (purchased separately) to the end of the power line for the type of wiring being installed follow all codes. (FIG.6).

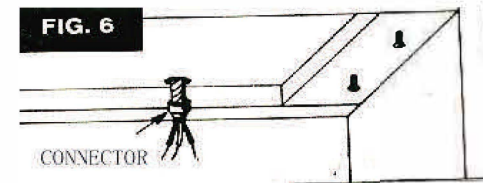

Step 5 - Mount the Range Hood to Cabinet

- Position the hood in place so that:

The electrical line is routed through the appropriate knockout opening. This step will have to be accomplished while positioning the hood (FIG.7).

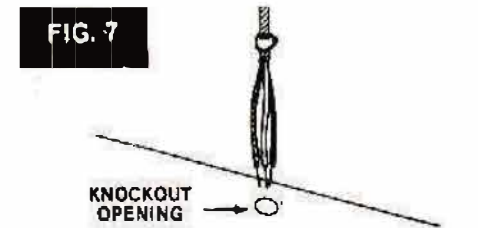

- Adjust the hood so the front is flush with the cabinet front.
- Tighten the hood mounting screws all the way into the cabinet or into the 1"x2" wood strips so the hood is secure.

Dimension:

- 5-1/2"
- 22"
- UC-C190ss-30 —30"
UC-C395ss-30—30"
UC-C395ss-36— 36"
- 7-7/8"

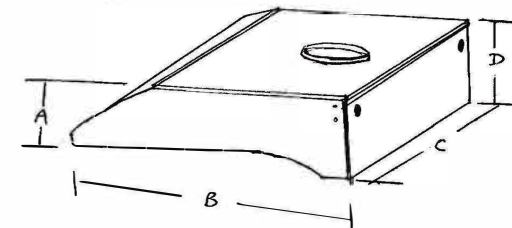

Step 6 - Electrical Connection



WARNING

Risk of electrical shock. Electrical wiring must be done by qualified personnel in accordance with all applicable codes and standards. Before connecting wires, switch power off at service panel and lock service disconnection means to prevent power from being switched on accidentally.

1. Connect cable to range hood wiring using wire connectors. Connect BLACK to BLACK, WHITE to WHITE, GREEN or BARE wire to GREEN wire.
2. Reinstall wiring box cover.
3. Plug back the small white connector (attached with the bottom panel) inside the hood.

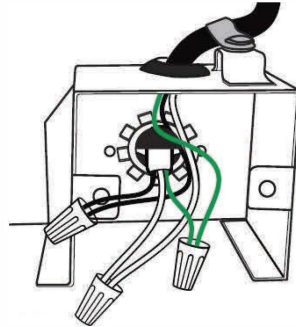

4. Reinstall bottom panel. Make sure both grease guides are aligned with the holes.
5. Using long nose pliers, pull out the end of each grease guides (A). Then, set them in such a way their slightly protrudes above the bottom panel surface (B).
6. Install the long grease cup at the end of the hood bottom.
7. Install the two small round grease guard cups onto the two metal guard. Push in and turn clockwise.

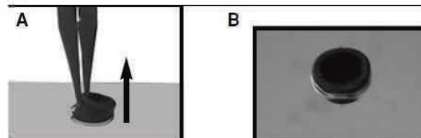
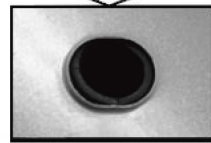

Model: C190 Standard Series

- A. Power Off Switch
- B. Low Speed Switch
- C. Middle Speed Switch
- D. High Speed Switch
- E. Light Switch

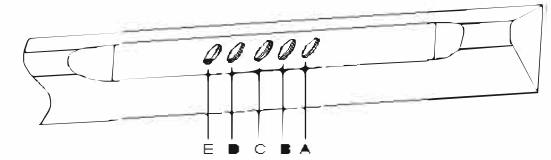

Model: C395 Premium Auto-clean Series

- A. Auto-Clean Switch— press once will go into the 38 seconds auto-clean mode. It will starts to spray the degreaser that stored at the water tank and clean up the fans, then automatically stop in 38 seconds.
- B. Low Speed Switch (6 speed step down)
- C. High Speed Switch (6 speed step up)
- D. Power On/off Switch
- E. Light Switch



Install / Replace of the Light Bulb

Light bulb is included in this package. For future replacement, this is a 110/120V, 40W A-15 type incandescent lamp (available at most hardware stores). We highly recommend using a 3.5W LED light bulb.

WARNING - If you use a bulb over 40W, it will seriously caused damage to the hood and the warranty will be voided!

Install of a light bulb

- 1) Turn off the power of the range hood
- 2) Unscrew the light diffuser retaining screw.
- 3) Rotate the 40W A-15 type incandescent lamp clockwise into the socket holder

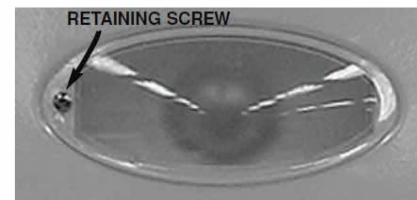

HOOD CLEANING

Stainless steel is known for its ability to be a clean surface that resists corrosion and rust. Dirt, dust and grime, however, put stainless at risk for corrosion and rust. Luckily, stainless steel responds well to cleaning, never wearing out from excessive cleaning, as long as certain rules are followed.

1. Water and a cloth. Routine cleaning can be accomplished by using warm water and a cloth. This is the least risky option for cleaning stainless steel. Dry with a towel or cloth to prevent water spots. Wipe in the directions of the polish lines.

2. Mild detergent, (dish washing liquid) and cloth. For cleaning that needs more power, mild detergent and warm water can do a great job without damaging the stainless steel. Make sure you rinse the surface thoroughly to prevent staining and spotting. Towel dry to prevent water spots which can be caused by minerals in water.

3. Glass cleaner for fingerprints. Fingerprints are one of the biggest complaints about stainless steel, but can be taken care of by using glass cleaner or household ammonia. Rinse thoroughly and towel dry. There are some newer types of finishes for stainless steel that resist fingerprints, a must if your pint-sized helpers leave their mark on your stainless steel appliances.

4. Stainless Steel Cleaner. If you've had staining or scratching, or need to polish your stainless steel, a stainless steel cleaner may be a good option. Some of these cleaners and polishes can help minimize scratching and remove stains. They also can polish stainless steel surfaces nicely. Read the directions on the stainless steel cleaner and test in an inconspicuous spot. Be sure to rinse thoroughly and towel dry.

Warning- When cleaning the hood, never spray cleaning agent directly on the controls; spray it on the cleaning cloth and wipe the control with it. Spraying cleaning agent directly on the control will cause unexpected keyboard activation.

Do not use any steel or stainless steel wool or any other scrapers to remove stubborn dirt.
Do not use any harsh or abrasive cleanser.
Do not allow dirt to accumulate.
Do not let plaster dust or any construction residues reach the hood. During construction or renovation,

cover the hood to make sure no dust sticks to stainless steel surface.

AVOID : when choosing a detergent

-Any cleaners that contain bleach will attack stainless steel.
 -Any products containing: **chloride, fluoride, iodide, bromide** will deteriorate surfaces rapidly.
 -Any **combustible products** used for cleaning such as **acetone, alcohol, ether, benzol**, etc., are highly explosive and should never be used close to a range.

Auto-cleaning function (Only for Model C395)

Use the white water kettle provided, mix with 2 portion of degreaser (DO NOT USE detergent) and 8 portion of water.

We recommend to use 409 degreaser.

Remove the cap at the top left of the range hood, Fill in the mixer into the hole (water tank). It can serve up to 8-10 times of Auto-cleaning function.

Stop to fill if over flow.

Status	Method of fixing
Bulb does not light	Check the light bulb, some base too flat cannot touch the base. Check for damaged control panel
Motor does not work	Check connection of power plug Check whether the vane is blocked Lubricate the motor Repair or replace damaged control panel Replace the capacitor Replace the motor
Machine vibrates when switch on	Fasten the body Check for damaged vanes Check if the vanes are installed well Fasten the motor
Big noise	Regulate bob-weight or replace the vanes Check whether some matters drop into the air chamber, like damper.
Weak suction	Lower the hood properly Do not open too many windows for improving the suction environment Replace the motor and the capacitor
Oil leakage	Remain the body level Replace the sealant
Unworkable cleaning	Replace the cleaning bump Replace the control machine

Maintenance

C395 (with Auto-clean function) - using this function weekly to maintain the inside cleanliness of the hood.

After long time of using the hood (about 6 months), you will see grease retained at the grease guard and blowers (inside the hood).

Follow the steps below :

Important - Switch power off at service panel and lock service disconnection means to prevent power from being switched on accidentally.

1. Disengage the small round grease guard cups from the grease guard by turning counter-clockwise and remove.
2. Remove the screw retaining the grease guard to the hood.
3. Remove the grease guard from the hood. Then remove the bottom panel.

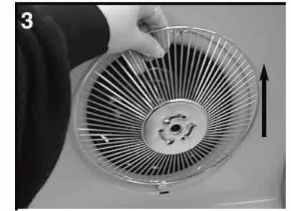
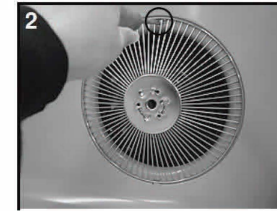
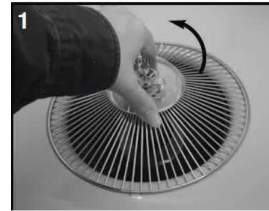

4. Unscrew the clips and remove the wheel grease collector.
5. Remove the wheel center cap.
6. Loosen the wheel set screw in order to disengage the wheel from its motor shaft.

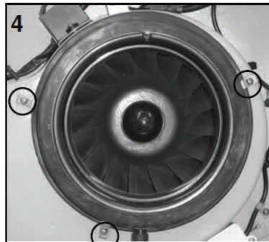

Let soak for 30 minutes all removed parts in warm soapy water. Then wash with nylon brush, rinse and dry completely before reinstalling.

NOTE: When reinstalling the wheel, align the end of the set screw with the flat part of the motor shaft (see the picture at right hand side)



Model: C190

Voltage	110V -120V / 60Hz	
Rotating method	Twin Motors	
Outlet diameter	6 Inch (150mm)	
Illumination	≤ 40W	
Motor	Left	Right
Power consumption	100W	100W
Air Flow	250-750 CFM	
Body Size	30" × 22" × 7-7/8"	

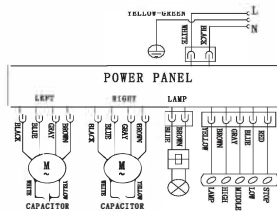

Model: C395 (with Auto-Clean)

Voltage	110V-120V~ /60Hz	
Rotating method	Twin Motors	
Outlet diameter	6 Inch (150mm)	
Illumination	≤ 40W	
Motor	Left	Right
Power consumption	100W	100W
Input power for cleaning	8W	
Suction power	810 ± 50 m ³ /hr	
Body Size	30" × 22" × 7-7/8" 36" x 22" x 7-7/8"	

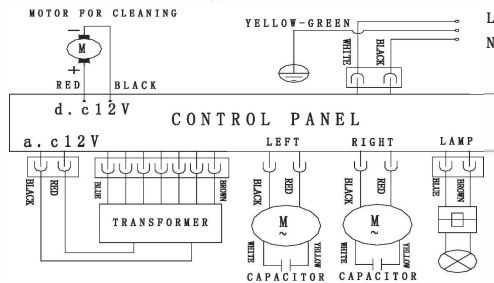

Service Parts

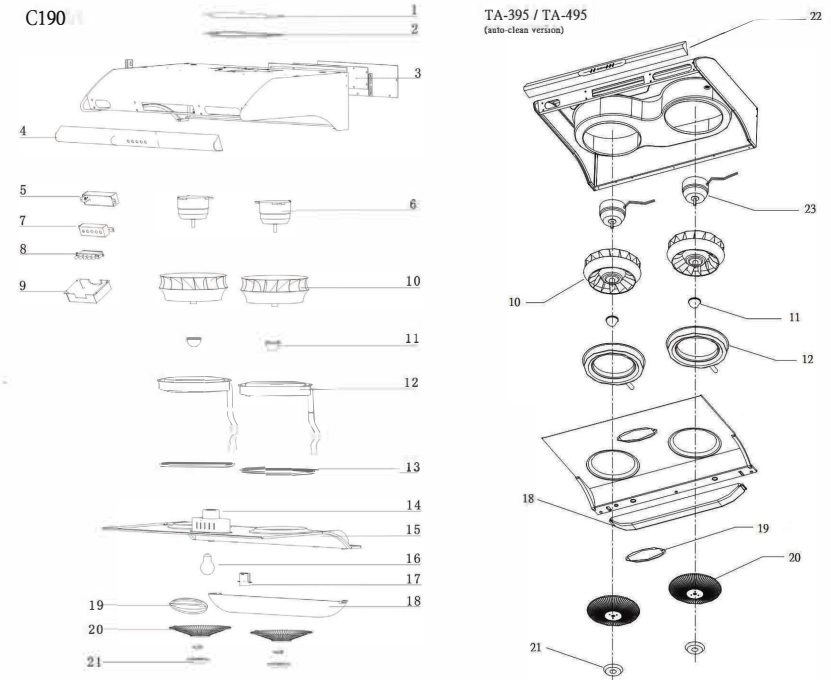

Parts number

- | | |
|-------------------------------|--|
| 1. Top Shutoff plate | 17. Light bulb socket |
| 2. Gasket | 18. Long grease cup |
| 3. Rear Shutoff plate | 19. Light diffuser with screw |
| 4. Front plastic panel (C190) | 20. Grease guard |
| 5. Switch box | 21. Small round grease cup |
| 6. Left or right motor (C190) | 22. Front plastic panel with switch
(UC-C395SS-30 <30"> / UC-C395SS-36 <36">) |
| 7. Switch box cover | 23. Left or right motor (C395) |
| 8. Push button | |
| 9. PCB cover | |
| 10. Vane (Left and right) | |
| 11. Vane cap | |
| 12. Inside round grease tray | |
| 13. Plastic rubber ring | |
| 14. Light bulb socket holder | |
| 15. Bottom panel | |
| 16. Light bulb (not included) | |