

BLUE  **TIGER**[®]

THE CLEAR CHOICE

BLUE TIGER[®] **ULTIMATE MANUAL**

www.BlueTigerUSA.com

YOUR FIRST CALL
SHOULD BE TO US!

+1 800 935 1165

Become part of the Blue Tiger Family by
registering your product today!

Congratulations on your purchase
of a **Blue Tiger[®] Bluetooth headset!**

Our mission is to help
professionals live safe and happy lives
while traveling on the road.



Important Safety Tip

Please be advised that several states have passed legislation prohibiting the use of dual ear style headsets while driving. Please remove the detachable speaker and use only the mono version of this headset while operating a vehicle. Please check your state's laws and above all, be safe!



Volume levels are measured in decibels (dB). Exposing your ears to any noise at or above 85 dB can cause gradual hearing loss.

According to the Occupational Safety and Health Administration (OSHA), listening to volume levels over 100 dB for more than two hours at a time can lead to hearing loss.

<http://www.osha.gov/SLTC/noisehearingconservation/#loud>

Table of Contents

- 4. Product Overview
- 5. Battery Care & Charging Instructions
- 7. Pairing Instructions
- 9. Pairing With Multiple Devices
(Multi-Point Pairing)
- 11. How to connect 3.5mm cable
- 12. In-Call Control
- 14. Controlling Your Music
- 16. LED Indication
- 17. Detachable Illustrations
- 19. Specifications
- 20. Precautions / Questions and Answers
- 22. Additional Applications
- 23. Available Accessories
- 24. Industry Leading Customer Support
- 24. One-Year Manufacturer's Warranty
- 27. FCC Compliance Statement
- 28. ISED Compliance Statement
- 29. RF Exposure Compliance Statement

Product Overview

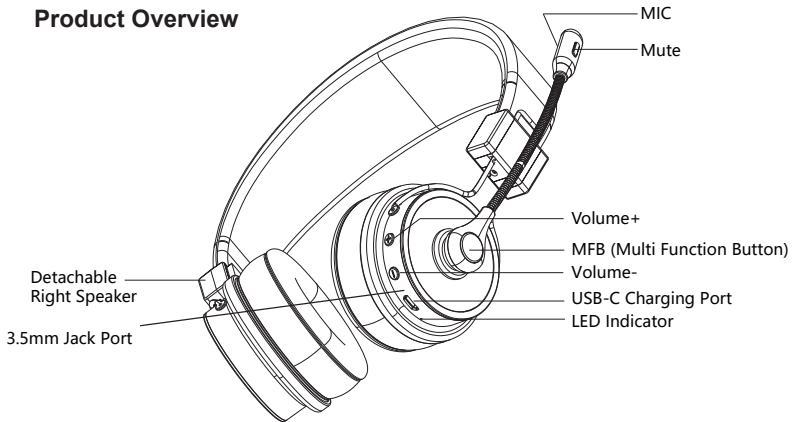

Battery Care & Charging Instructions

Your BlueTiger® Ultimate headset uses a high-quality Lithium Polymer battery. Fully charged, it allows up to 60 hours talk time and continuous use listening to music. Actual battery life between charging will vary based on your headset usage patterns.

Once your battery is low, the red-light indicator will blink intermittently.

Please connect to the charging port of your Ultimate headset through the TYPE-C connector of the TYPE-C charging cable, and connect to the USB charger (car charger, travel charger, computer USB, etc.) through the USB connector.

When charging the headset, the LED indicator light will display a red light. It will blink blue intermittently if the headset is also turned on (Blue and Red LED will override if power is on while charging). When fully charged, the red indicator light will turn off.

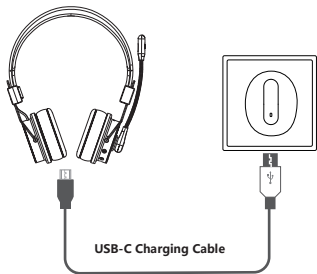

Connect With Charger For Charging

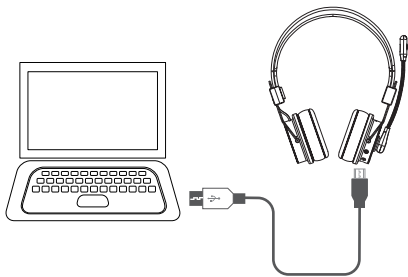

Connect With Computer For Charging

Please charge your Ultimate every 2 months at minimum (when used infrequently). The Bluetooth headset will automatically reset and turn off when charging in the on state.

Pairing Instructions

1. Ensure your Blue Tiger[®] Ultimate headset is in the off position. Press & hold the black MFB button located on the microphone boom for 3 seconds. You will hear “headset on”, then the unit will enter into pairing mode (red and blue lights will flash alternately automatically) and you will hear “ready to pair”. If the headset was already connected with another device, it will connect to that device automatically, and you will hear “headset connected”.
2. On your phone, access your Bluetooth menu, select “Add New” or “Search New Devices”. With your BlueTiger[®] headset in pairing mode, your phone should locate your headset. Check your phone’s pairing procedures to pair the Ultimate to your phone.
3. On your phone, select Ultimate from the list. A passkey or PIN code message may appear. If so, input “0000”, you should then hear “device connected”.

1

Pairing

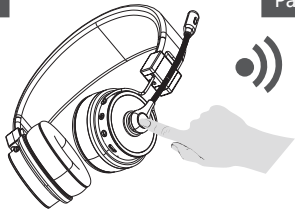

Long press MFB 3 seconds. Pairing mode begins when Blue and Red LED lights flash alternately.

2

Connection

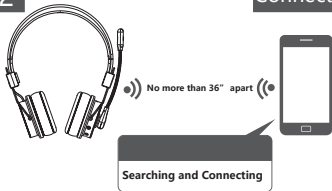

Access Bluetooth settings on your phone to search for Ultimate.

Pairing with Multiple Devices (Multi-Point Pairing)

To connect your Blue Tiger[®] Ultimate headset to two Bluetooth devices simultaneously, follow the instructions below.

1. Pair with the first device. (Follow “Pairing Instructions” for the first device.)
2. On the first device: turn off Bluetooth or disconnect from Ultimate. You should hear “ready to pair” in the headset.
3. On the second device, access the Bluetooth menu, and select Ultimate from the pairing list. Enter passkey or PIN code if necessary. You should hear “headset connected”.
4. On the first device turn on Bluetooth and/or reconnect your Ultimate headset from the list of devices. You should hear a second “headset connected” alert.
5. Your Ultimate headset is now paired with both devices.

If you need further assistance on pairing two devices, please give us a call at 800-935-1165.

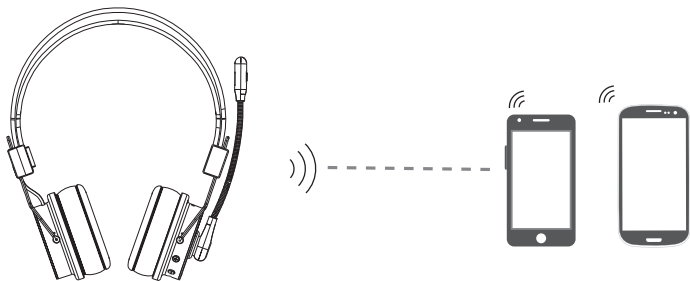

When connected with two mobile phones, the Ultimate plays music or makes calls from one device at a time, the device primarily chosen for calls or music. You may still easily alternate between the two devices in Bluetooth settings.

How to connect 3.5mm cable for wired headphone experience

Wired headset use method

- A. Use the original four-section 3.5mm audio cable, one end into the audio interface of the headset, one end into computer's audio port.
- B. The computer plays music or through the internet phone, you can listen from the headset and talk through the MIC of the headset.

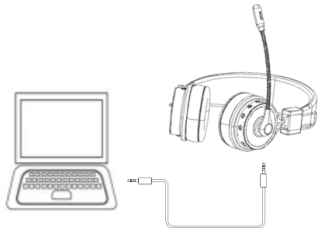

*Note.

- a. When used as wired headphones, all the buttons on the headset for no function.
- b. The headset in the power-on state when the audio cable is inserted, will automatically turn off the Bluetooth, switch to wired headset mode.
- c. Please use the original four 3.5mm audio cable, other audio cables may cause abnormal calls or listening.

In-Call Control

The Blue Tiger® Ultimate is fully loaded with caller functionality. Without ever touching your phone, the Ultimate allows you to make calls, answer calls, redial, take incoming calls while already on a call, and have text messages read back to you.

To answer a call, press the Multi-Function button (MFB). To hang up, press the MFB again.

To redial the last number dialed, double click the MFB in quick succession.

To adjust volume up or down, short press button with (+) or (-) symbol until you have reached your desired volume.

For voice dialing, tap the MFB and wait for your audio device to respond. After your device responds, speak your command, “Call John Doe”.

To mute/unmute the microphone, double press “Mute” button to mute the mic and double click “Mute” button again to unmute the MIC.

Another call comes in while you're talking:

Short press MFB to end the current call and answer that in-coming call.

Double press MFB to keep the current call and ignore / reject the in-coming call.

Hold MFB for 1 second to receive the new call and keep the current call, hold and press MFB for 1 second to switch between current and incoming call.

(Three way calling must be supported by your mobile phone.)

Controlling Your Music

Your Blue Tiger[®] Ultimate headset is equipped with A2DP functionality. This technology makes it possible for you to control music and videos on your Bluetooth device directly from your headset.

When listening to music, press and hold “Mute” button for 2 seconds to pause or play your music.

To skip to the next song, press and hold button with (+) symbol for 1 second.

To skip back to the previous track, press and hold button with (-) symbol for 1 second.

To turn volume up, short press volume (+) until you reach the desired volume.

To turn volume down, short press volume (-) until you reach the desired volume.

Status	LED indication
Power On	Blue LED flashes twice.
Power Off	Red LED flashes twice.
Pairing Mode	Red and Blue LED flashes alternately.
Connected Standby	Blue LED flashes once every 10 seconds.
Music Playing Mode	Blue LED flashes once every 10 seconds.
Talking Mode	Blue LED flashes once every 10 seconds.
Clear Pairing List	Blue and Red LED flashes once simultaneously.
Charging	Solid Red (Charging while power on, Red LED will override the Blue LED).
Fully Charged	Red LED turns off.
Low Voltage	Red LED flashes (Please charge the headset).

Detachable Illustration

The right speaker of the Ultimate is detachable. When you detach the right speaker, the Ultimate becomes a monaural (single speaker) headset.

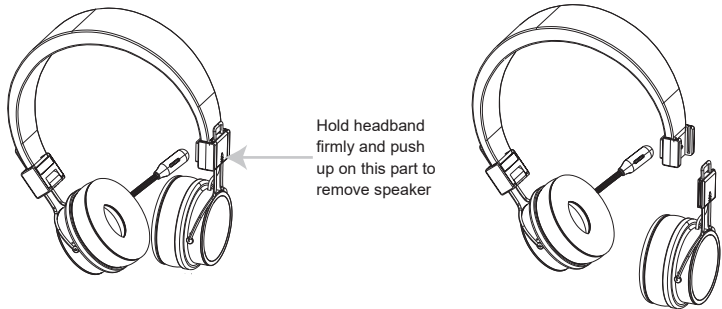

When you re-attach the right speaker, the Ultimate becomes a binaural (dual speaker) headset with high fidelity stereo sound when playing music. To ensure a positive connection, make sure the speaker connector (plastic part with “UP” arrow) is fully seated on the headband with a positive ‘click’.

NOTE: *If no sound is heard coming from the right speaker, detach it and re-attach the connector firmly. Make sure the electrical contacts are clean and free of debris such is lint, dust, and dirt.*

Specifications

Bluetooth Specification	Bluetooth V5.2
Operation Frequency	20-10kHz
Supported Profile	HSP v1.2,HFP v1.6,A2DPv1.2, AVRC v1.4
Chipset Solution	CSR 64215
Operation Range	Up to 30 meters (= 100 feet) (Actual working distance is up to the connected device.)
Talk Time/Music Playing	Up to 60 hours
Standby Time	Up to 1200 hours (under max volume)
Charging Time	Approx. 1.5 hours
Battery Type	420mAh, 1.554Wh/3.7V Lithium polymer battery
Overall Dimension	39x22.6x4.5mm
Net Weight	About 177g (= 0.4 lb)

Precautions / Questions and Answers

A. How do I re-connect headset? What if I can't re-connect?

When "Ultimate" and your mobile device are successfully connected, the headset will automatically connect back to your mobile device when you use it again. Pairing state, short press the multi-function button, the headset can take the initiative to connect back to the last device, if you can not connect back, please re-pair using instructions from quick start guide.

B. How to clear the pairing record?

In the power on state (non-call state), press and hold the volume up and volume down keys at the same time for 5 seconds, the red and blue lights will flash once at the same time to clear the pairing record, Ultimate will not connect back to the previously connected devices. You can try to clear the pairing record when there are various connection exceptions.

C. What is the pairing password?

If you are prompted to enter a password when connecting to Elite Plus Ultimate, try entering 0000 (four zeros), 8888 (four eights), 1111 (four ones), or 1234.

D. What devices can I use to charge?

As long as the DC voltage is 5V and the current is 500mA or more, car charger, travel charger, computer USB, etc. can be used to charge Ultimate.

E. What if I do not hear sound coming from the right/detachable speaker? Disconnect the speaker. Make sure the electrical contacts are free of debris such as lint, dust and dirt. You may need to clean the contact points gently with a dry, soft cloth. Do not use water. Re-attach the speaker firmly. Take care not to disconnect the speaker while adjusting the headband.

If you still hear no sound, please contact Blue Tiger® USA at 800-935-1165 for support.

F. How do I change the language on my headset?

Press Volume Up and Mute Button simultaneously for 1 second. Voice prompts offered in English, Spanish & French.

Additional Applications

Feel free to connect your BlueTiger[®] Ultimate to any Bluetooth[®] enabled PC, Mac, game system or other Bluetooth[®] enabled device to enjoy online chat or audio.

Note: Certain functions may not work when paired with a laptop or PC. Example, the MUTE function.

Available Accessories

Additional and replacement accessories are available for your BlueTiger® Ultimate through customer service 1-800-395-1165.

Detachable Speaker

The Hook Headset Hanger

A/C Wall Adapter

D/C Car Charger

Mic Covers

Replacement Ear Cushions

Industry Leading Customer Support

At Blue Tiger USA, we stand behind our products. We believe that our customer service does not end when we process your payment, but it continues for as long as you use our headset.

One-Year Manufacturer's Warranty

- (1) Blue Tiger USA warrants that your product will be free from defects in material and workmanship for one year from the date of purchase. If, during the first year from the date of purchase, your product fails to work due to a defect in material or workmanship, Blue Tiger USA will repair or replace the product, at its election, free of charge. Without proof of purchase, the warranty period begins on the date of manufacture. Consumable components (for example, cushions and battery) are not included in this one-year warranty.

- (2) The foregoing limited warranty does not cover equipment failure attributable to accident, improper operation, misuse, abuse, or any cause other than defects in the materials or workmanship of Blue Tiger USA products.
- (3) Blue Tiger USA obligations under this warranty are limited to repair or replacement (at our option) of any defective part returned to Blue Tiger USA at the customer's expense. Returned products require a Return Authorization that may be obtained by calling 800-935-1165 or visiting BlueTigerUSA.com. Products returned to Blue Tiger USA for repair under this warranty will be return shipped to the customer at Blue Tiger USA expense.

(4) THIS LIMITED WARRANTY IS IN LIEU OF ALL OTHER WARRANTIES, EXPRESSED OR IMPLIED, INCLUDING THE IMPLIED WARRANTIES OF MERCHANTABILITY AND FITNESS FOR A PARTICULAR PURPOSE.

Some jurisdictions do not permit the exclusion of implied warranties and the foregoing exclusions may not apply to you.

(5) In no event shall Blue Tiger USA be responsible for any other damages whatsoever, including direct, indirect, special, incidental, consequential, or other damages for breach of this or any other warranty, expressed or implied.

Blue Tiger[®] is registered trademark by North American Blue Tiger Company, LLC registered in the United States and other Countries.

FCC Compliance Statement:

NOTE: This device complies with Part 15 of the FCC Rules. Operation is subject to the following two conditions: (1) this device may not cause harmful interference, and (2) this device must accept any interference received, including interference that may cause undesired operation.

Note: This equipment has been tested and found to comply with the limits for a Class B digital device, pursuant to Part 15 of the FCC Rules. These limits are designed to provide reasonable protection against harmful interference in a residential installation. This equipment generates, uses and can radiate radio frequency energy and, if not installed and used in accordance with the instructions, may cause harmful interference to radio communications. However, there is no guarantee that interference will not occur in a particular installation. If this equipment does cause harmful interference to radio or television reception, which can be determined by turning the equipment off and on, the user is encouraged to try to correct the interference by one or more of the following

measures:

- Reorient or relocate the receiving antenna.
- Increase the separation between the equipment and receiver.
- Connect the equipment into an outlet on a circuit different from that to which the receiver is connected.
- Consult the dealer or an experienced radio/TV technician for help.

CAUTION: Changes or modifications not expressly approved by the party responsible for compliance could void the user's authority to operate the product.

ISED Compliance Statement:

This device contains licence-exempt transmitter(s) that comply with Innovation, Science and Economic Development Canada's licence-exempt RSS(s).

Operation is subject to the following two conditions:

1. This device may not cause interference.
2. This device must accept any interference, including interference that may cause

undesired operation of the device.

L'émetteur exempt de licence contenu dans le présent appareil est conforme aux CNR d'Innovation, Sciences et Développement économique Canada applicables aux appareils radio exempts de licence. L'exploitation est autorisée aux deux conditions suivantes:

1. L'appareil ne doit pas produire de brouillage;
2. L'appareil doit accepter tout brouillage radioélectrique subi, même si le brouillage est susceptible d'en compromettre le fonctionnement.

RF Exposure Compliance Statement:

This equipment complies with IC RSS-102 radiation exposure limits set forth for an uncontrolled environment. This transmitter must not be co-located or operating in conjunction with any other antenna or transmitter.

Cet équipement est conforme aux limites d'exposition aux radiations IC CNR-102 établies pour un environnement non contrôlé. Cet émetteur ne doit pas être situé ou fonctionner conjointement avec une autre antenne ou un autre émetteur.

BLUE  **TIGER**[®]

THE CLEAR CHOICE