

THIS DOCUMENT IS THE PROPERTY OF DESIGN PRODUCT REPRODUCTION OR USE WITHOUT PRIOR PERMISSION IS PROHIBITED

PDF.No. _____ DATED : _____

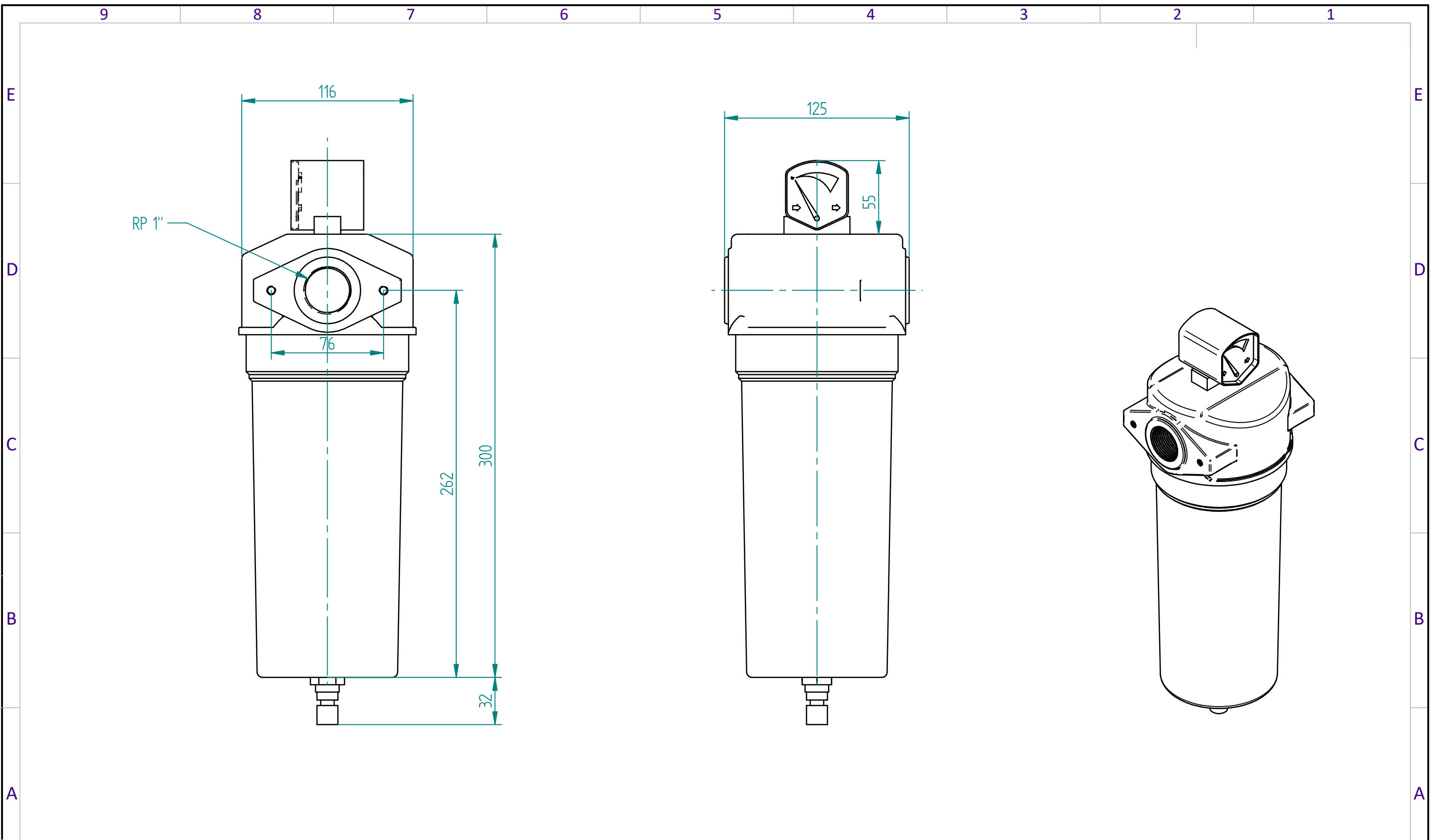

REV	0	AMENDMENT			SIGN	DATE
MAT'L :		QTY / SET:				
FINISH :		1 No				
DRAWN	AF	CHKD. 13.07.2023	APPD. 13.07.2023	ENGG	QA	
DATE :	13.07.2023.	CUSTOMER :			UNIT : mm	
MODEL :	-	SCALE : N.T.S.			PART CODE:	
TITLE :	SAF 185- Filter			DRG. NO.	REV	
USED ON :	-			SHEET 1 OF 1		

FILE PATH :-