



PRICE LIST 15-05-2024

Veranda systems



Contents

| | |
|---|--------------|
| PROFILE SYSTEMS | p. 5 |
| Overview (RAL) colours for the profile systems | p. 8 |
| SELF-SUPPORTING NON-THERMAL PROFILE SYSTEM (cold roof) | p. 10 |
| CLIMALUX | p. 10 |
| Quick calculator Climalux without roof overhang | p. 12 |
| Quick calculator Climalux without roof overhang freestanding roof | p. 14 |
| Quick calculator Climalux standard roofs without roof overhang | p. 16 |
| CLIMALUX HORIZON | p. 18 |
| Quick calculator Climalux Horizon | p. 20 |
| Quick calculator Climalux Horizon freestanding roof | p. 22 |
| CLIMACROWN ROOF (cold roof) | p. 24 |
| Quick calculator Climacrown | p. 26 |
| Quick calculator Climacrown freestanding roof | p. 28 |
| CLIMAX PANORAMA (cold roof) | p. 30 |
| Quick calculator Climax Panorama | p. 32 |
| Quick calculator Climax Panorama with IPE120 steel reinforcement in the gutter (standard colour & 5° pitch) (IPE120 not included in the price) | p. 34 |
| Quick calculator Climax Panorama freestanding roof | p. 36 |
| SELF-SUPPORTING THERMAL PROFILE SYSTEM (warm roof) | p. 38 |
| CLIMAX | p. 38 |
| Price list profiles and accessories for Climax, Climalux, Climacrown, Triangle, Windbreak and Climaglide | p. 40 |
| ACCESSORIES FOR SELF-SUPPORTING PROFILE SYSTEMS | p. 64 |
| TRIANGLE | p. 64 |
| WINDBREAK | p. 65 |
| CLIMAGLIDE | p. 66 |
| VERTICAL SUNBLIND | p. 68 |
| ROOF SUNBLIND | p. 81 |
| CLIMALED | p. 84 |
| NON-SELF-SUPPORTING PROFILE SYSTEMS | p. 85 |
| PERGOLUX | p. 85 |
| Price list Pergolux D-series | p. 86 |
| Standard series | p. 88 |
| Price list Pergolux | p. 90 |



OUR PLASTIC SHEETS FOR VERANDA SYSTEMS

| | |
|-------------------------------------|--------|
| | p. 100 |
| Polyclear price list | p. 100 |
| PLEXIGLAS® price list | p. 103 |
| Pergotop – Pergotop-Soft price list | p. 104 |

PRICE INQUIRY / ORDER

| | |
|----------------------------|--------|
| | p. 105 |
| Cimalux | p. 105 |
| Cimalux with roof overhang | p. 106 |
| Cimalux Horizon | p. 107 |
| Climacrown | p. 108 |
| Climax Panorama | p. 109 |
| Climax | p. 110 |
| Pergolux | p. 111 |
| Climaglide | p. 112 |
| Triangle / Windbreak | p. 113 |
| Vertical sunblind | p. 114 |
| Roof sunblind | p. 115 |

DEMO MATERIAL

p. 116



If you would like to submit a price request or an order, please use our order forms on pages 105-115. You can send us the completed order form by e-mail to com.canopy@skylux.be or you can call us at +32 (0)56 20 00 00.

Useful information for quick rate use

A patio roof offers a perfect solution for extending your home. Our range consists of both non-self-supporting profiles for use on a timber structure and of self-supporting aluminium profiles.

Self-supporting or non-self-supporting (p. 10-99)

Self-supporting profile systems (p. 10-84) require no extra support from wood or metal. We offer a wide selection through Climalux, Climalux Horizon, Climacrown, Climax and Climax Panorama.

The non-self-supporting systems (p. 85-99) are supported by timber or metal joists. Our range of Pergolux systems offers a wide selection of possibilities for any type of glazing.

Thermal or non-thermal

Thermal profiles are ideal for closed structures. These profiles are thermally insulated and prevent condensation. Among the self-supporting systems, the Climax roof offers these thermal qualities, as do the Pergolux Therm, Pergolux Color-Therm and Pergolux Color-Therm Glass among the non-self-supporting systems.

Non-thermal profiles are suitable for open structures where there is no temperature difference between the inside and outside areas, as with verandas. The self-supporting systems Climalux, Climalux Horizon, Climacrown, Climax non-thermal and Climax Panorama can be used for this purpose. For non-self-supporting applications, the Pergolux series Alu and Color and the D series offer a good solution.

Glazing

Our veranda roofs can be fitted with multi-walled plastic sheets – 16 or 32mm thick – in polycarbonate (Polyclear) or acrylic (PLEXIGLAS[®]) and/ or glass – 8 or 10mm thick laminated glass or thermal glass up to a maximum of 34mm thick – and/or sandwich panels (Pergotop-Soft).

Broad range of options

Apart from traditional rectangular pitched roofs, our systems also offer the possibility of implementing L shaped or differently shaped roofs (roofs around a corner, a recess for a balcony, etc.) or also applications with sloping sides. Certain systems can also be used to construct a gable roof.

Colours

Skylux patio roofs are available in different RAL colours. See pages 8-9.

Price lists

This price list is published yearly. Any intermediate price changes are updated in the online version of this price list (see www.skylux.eu).

Components price list

You will find a complete list with names, drawings and prices for all Pergolux parts and accessories: see p. 90-99. For a more detailed list of parts and accessories for all self-supporting systems: see p. 40-60.

Quick price calculator

This price list also contains 'quick calculators' for a number of veranda roofing systems. They enable you to quickly know the price for a number of standard sizes in a particular combination of profiles. **Please note: these prices are indicative and not binding. The plastic sheets are not included in the price.** You will find these quick price calculators on the following pages:

- Climalux: p. 12-15
- Climalux standard roofs: p. 16-17
- Climalux Horizon: p. 20-23
- Climacrown: p. 26-29
- Climax Panorama: p. 32-37

Tips

Download our Climafast & Pergofast calculation programmes (www.skylux.be/calculations) to produce quick and accurate quotations. Use our order forms (p. 105-115) to place your orders.

NEW

Roof sunblind..... p. 81

Terms and conditions of sale

- We explicitly refer you to our general terms and conditions of sale, technical sheets and installation manuals.
- Prices are in EUR, gross and excluding VAT.
- This rate supersedes all previous rates.
- This price list was compiled with the utmost care. However, we cannot be held liable for any printing or calculation errors, nor for price fluctuations.
- You will always find the latest prices on our website www.skylux.eu.

Profile systems

Self-supporting profile systems

There is a wide and multi-faceted range of self-supporting systems:

- Climalux (p. 10)
- Climalux Horizon (p. 18)
- Climacrown (p. 24)
- Climax Panorama (p. 30)
- Climax thermal (warm) (p. 38)



Ask for our Climafast calculation tool to produce quick quotations

Use our order forms to place your orders.

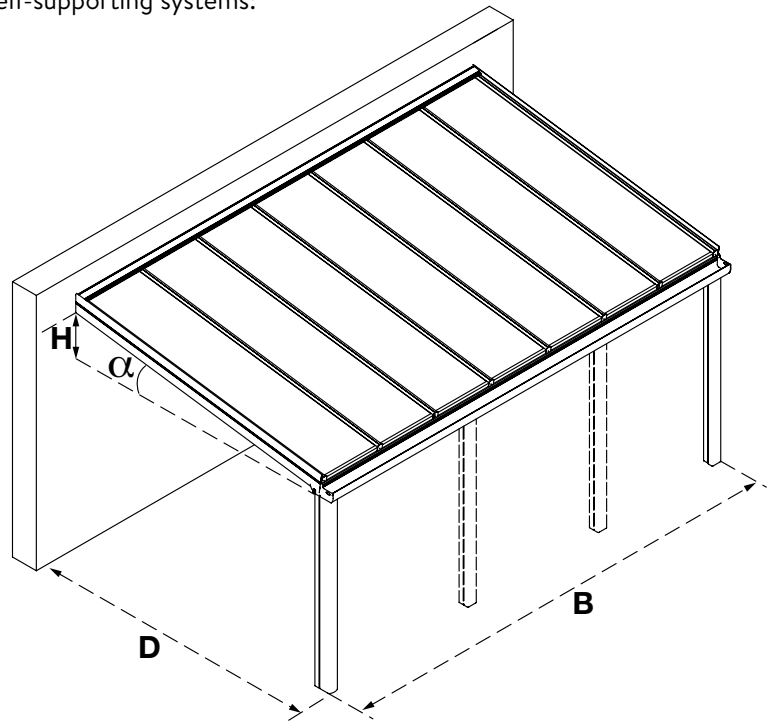

Non-self-supporting profile systems

We offer a wide range of non-self-supporting profile series under the brand name Pergolux (see p. 51 to 65):

- Pergolux D-Serie (p. 86-87)
- Pergolux standard series (p. 88-89)



Ask for our Pergofast calculation tool to produce quick quotations

Use our order forms to place your orders.

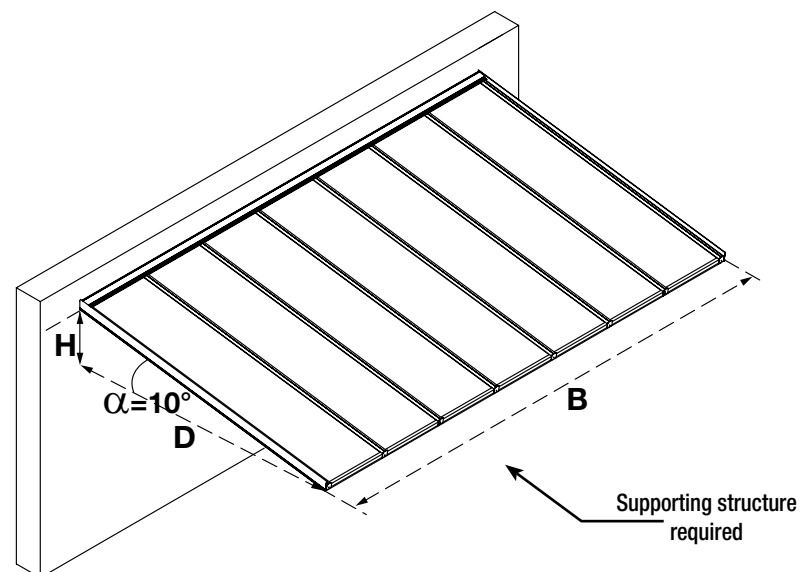

SELF-SUPPORTING

COLD ROOFS
Non-thermal profile system

CLIMALUX

- profiles made to fit
- some standard sizes are already prepacked in stock
- for 16 and 32mm plastic sheets or 8 and 10mm glass
- maximum depth of 5.5m
- the roof pitch varies between 2° and 10° and starting from 5° with multi-walled sheets
- optional roof overhang
- optional freestanding roof
- optional LED spotlights with mounting profile
- easy installation
- CE certified in accordance with EN 1090-3

CLIMALUX HORIZON

- profiles made to fit
- new gutter for pan lengths up to 6m with just two support posts
- sleek and contemporary design
- for 16 and 32mm plastic sheets or 8 and 10mm glass
- maximum depth of 5.5m
- the roof pitch varies between 2° and 10° and starting from 5° with multi-walled sheets
- optional freestanding roof
- optional LED spotlights with mounting profile
- easy installation
- CE certified in accordance with EN 1090-3

CLIMACROWN

- profiles made to fit
- elegant crown profile on the front and on the sides
- sleek and contemporary design
- for 16 and 32mm plastic sheets or 8 and 10mm glass
- maximum depth 4m
- roof pitch of 2° and starting from 5° with multi-walled sheets
- optional freestanding roof
- optional LED spotlights with mounting profile
- easy installation
- CE certified in accordance with EN 1090-3

NON-SELF-SUPPORTING

COLD ROOFS
Non-thermal profile system

PERGOLUX ALU

A system with aluminium profiles and standard grey coextruded rubber strip

- extensive range of standard lengths
- for 16mm and 32mm thick plastic sheets
- only available in mill finished aluminium
- variable pitch
- simple construction and installation

PERGOLUX COLOR

A system with coated aluminium profiles and white coextruded rubber strips

- extensive range of standard lengths
- for 16mm and 32mm thick plastic sheets
- variable pitch
- simple construction and installation

PERGOLUX D-SERIES

A system with non-self-supporting aluminium profiles and standard grey coextruded rubber strips

- extensive range of standard lengths
- for 16mm thick plastic sheets or glass (glass only in combination with bottom rubber strips)
- only available in mill finished aluminium
- optional alu covering clips to hide screw heads (also available in white)
- variable pitch
- simple construction and installation

* SKYLUX PATIO ROOFS ARE AVAILABLE

PROFILE SYSTEMS

HOT ROOFS
Thermal profile system

CLIMAX PANORAMA

- gutter span up to 7m with just two support posts
- integrated LED lighting in the gutter possible
- profiles made to size and pre-assembled
- for 16 or 32mm thick plastic sheets or for 8 or 10mm thick glass
- maximum depth of 5.5m
- the roof pitch varies between 2° and 20° and starting from 5° with multi-walled sheets
- optional freestanding roof
- option for Climaled profile with LED spotlights under the supports
- various construction methods available
- CE certified in accordance with EN 1090-3

CLIMAX THERMAL

- gutter span up to 7m with just two support posts (when using the raised gutter post GD2)
- profiles made to size and pre-assembled
- for 16 or 32mm plastic sheets or glass up to 34mm thick
- maximum depth 5.5m
- variable pitch from 5° to 45°
- option for Climaled profile with LED spotlights under the supports
- various construction methods available
- CE certified in accordance with EN 1090-3

PROFILE SYSTEMS

HOT ROOFS
Thermal profile system

PERGOLUX
COLOR-THERM

Thermal profile system with aluminium clips in coated version

- extensive range of standard lengths
- for 16mm and 32mm thick plastic sheets
- variable pitch
- simple construction and installation

PERGOLUX
COLOR-THERM GLASS

Thermal profile system for glass with aluminium screw clips

- extensive range of standard lengths
- for glass of 8 to 34mm thick
- variable pitch
- simple construction and installation

IN DIFFERENT RAL COLOURS. SEE PAGES 8-9.

Overview (RAL) colours for the

SELF-SUPPORTING PROFILE SYSTEMS

- **Climalux, Climalux Horizon, Climacrown, Climax Panorama and Climax thermal** are available as follows:

→ 2 standard RAL colours



white RAL 9010 (code RWB964)



anthracite RAL 7016 ST (code 029/71334)

Delivery time: **max. 3 weeks**

→ 9 “trend” RAL colours



cream white RAL 9001 (code AE70019220225)



black RAL 9005 ST (code AE03054900520)

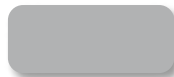

white aluminium RAL 9006 ST (code 029/90146)



grey aluminium RAL 9007 ST (code 029/90147)



RAL 9009 ST (DB703) (code 029/80077)



RAL 9010 ST (code AE03059901020)



purple red RAL 3004 ST (code AE03053300420)



RAL 7039 ST (code AE03057703920)



RAL 8014 ST (code AE030588001420)

Surcharge: € 200 net

Delivery time: **max. 4 weeks**

→ Other RAL colours (*)

15% surcharge + surcharge of € 200 net

Delivery time: **max. 4 weeks**

* For the RAL colours not mentioned in our colour list, there is a 15% surcharge and an additional surcharge of € 450 net. You can consult this colour list with the calculation programme Climafast. The price for all other colour codes is available on request.

profile systems

NON-SELF-SUPPORTING PROFILE SYSTEMS

● Pergolux Alu



mill finished aluminium

● Pergolux D-series



mill finished aluminium

● Pergolux Color

→ 1 standard RAL colour



white RAL 9010

● Pergolux Color-Therm

→ 2 standard RAL colours



white RAL 9010



RAL 7016 ST (**)

● Pergolux Color-Therm Glass

→ 2 standard RAL colours



white RAL 9010



RAL 7016 ST (**)

→ Other RAL colours (*)

15% surcharge + surcharge of € 200 net

Delivery time: **max. 4 weeks**

** Only the profiles visible on the outside are delivered in this RAL colour.

The colour display is indicative: there can be a difference between the CMYK display (prints), the RGB display (digital) and the RAL execution (lacquer).

SELF-SUPPORTING NON-THERMAL PROFILE SYSTEM (cold roof)

CLIMALUX

Climalux is the basic version of the Climax profile range and is primarily used as a patio roof or canopy. A roof overhang is also possible.

This self-supporting profile system is supplied made-to-measure and can be installed very quickly. The Climalux roof is self-supporting up to 5.5m in width between two posts, with 16mm plastic sheets (with a depth of 3m). It is self-supporting up to 5.5m in depth. The roof pitch varies between 2° and 10° and starting from 5° with multi-walled sheets.

Climalux can be built with or without roof overhang. A roof overhang of maximum 710mm (outer side of the gutter) is possible.

- 2 standard RAL colours: white RAL 9010 & anthracite RAL 7016 ST. Delivery time: max. 3 weeks.
- 9 “trend” RAL colours: cream white RAL 9001, black RAL 9005 ST, white aluminium RAL 9006 ST, grey aluminium RAL 9007 ST, RAL 9009 ST (DB703), RAL 9010 ST, purple red RAL 3004 ST, RAL 7039 ST & RAL 8014 ST. Surcharge: € 200 net. Delivery time: max. 4 weeks.
- Other RAL-colours: see p. 8 & 9 (price on request). Delivery time: max. 4 weeks.

The Climalux veranda roof can also be installed with 8 to 10mm glass (not supplied by Skylux).

Climalux can also be fitted with Climaled (see p. 84).

Important: some standard sizes (for multi-walled plastic sheets) are already prepacked in stock and can be delivered within a week of the order date (see p. 16).



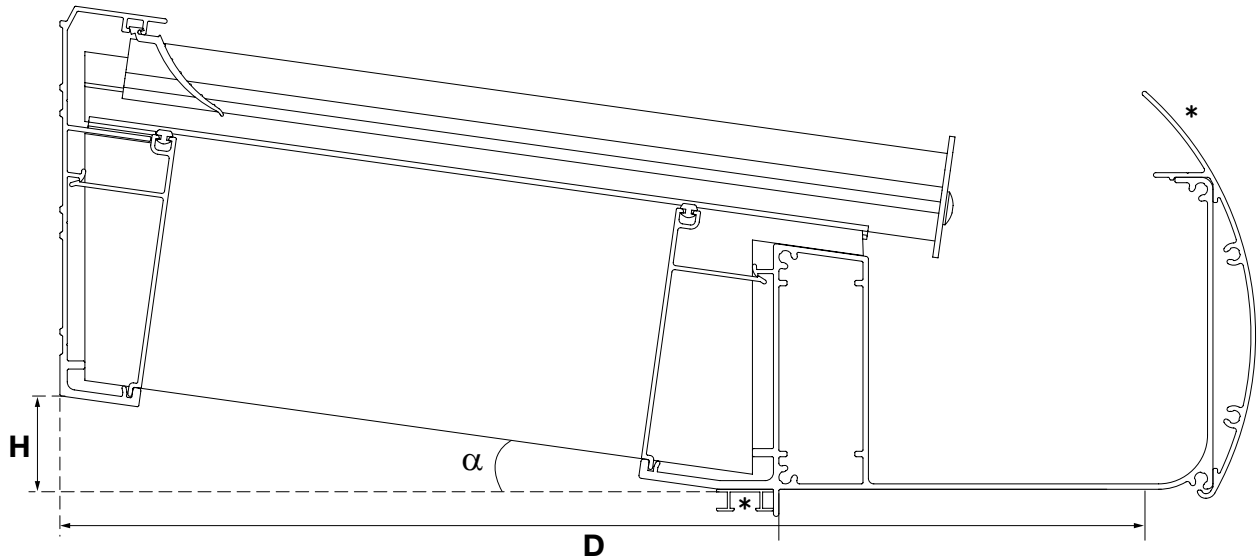

* Softline gutter top piece and LED Strips optional

Options

- Width B: ∞
- Depth D: max. 5641mm with support 110 x 141 or 5650mm with support 150 x 150
- The roof pitch α varies between 2° and 10° and starting from 5° with multi-walled sheets

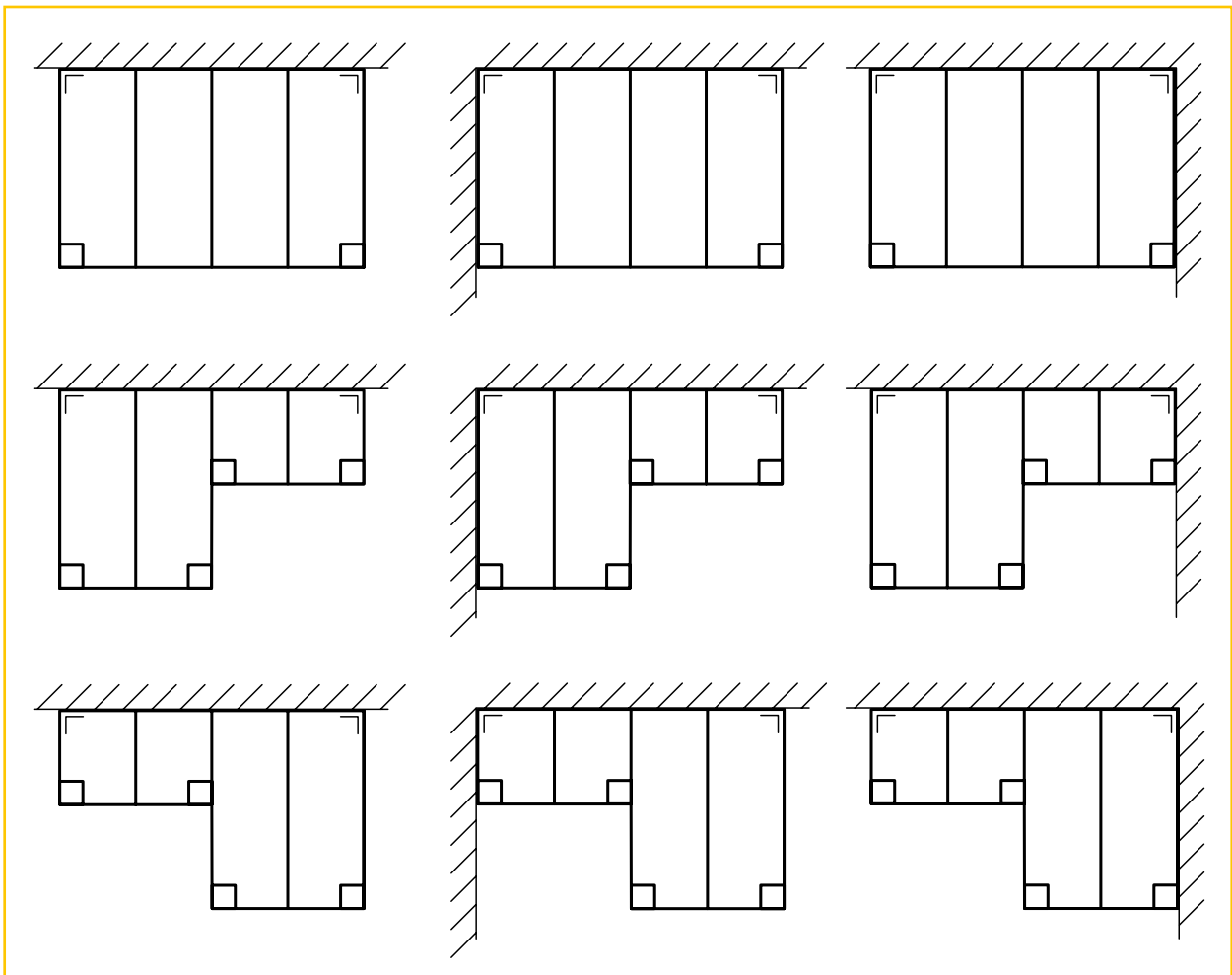

Quick calculator Climalux without roof overhang

Info:

- Aluminium profile system with Classic gutter and aluminium push clips
- 2, 3 or 4 posts 110 x 141 x 2500mm are included in the price
- The roof pitch varies between 2° and 10° and starting from 5° with multi-walled sheets
- 2 standard RAL colours: white RAL 9010 & anthracite RAL 7016 ST – delivery time: max. 3 weeks
- 9 “trend” RAL colours: cream white RAL 9001, black RAL 9005 ST, white aluminium RAL 9006 ST, grey aluminium RAL 9007 ST, RAL 9009 ST (DB703), RAL 9010 ST, purple red RAL 3004 ST, RAL 7039 ST & RAL 8014 ST – surcharge: € 200 net – delivery time: max. 4 weeks
- Other RAL colours: see p. 8 & 9 (price on request) – delivery time: max. 4 weeks
- Plastic sheets or glass not included in the price
- Maximum deflection of the profiles: 1/200
- Drainpipe and accessories included

Calculate the price as follows:

- Measure the roof’s width B (mm) and depth D (mm).
- Select the next size up in the table and read off the prices of the profiles.
- Multiply the sheet or glass area, indicated in the same box, by the price/m² of the sheet or the glass (not supplied by Skylux).

For 16mm sheets without roof overhang

| CLIMALUX CLASSIC prepared for 16mm thick and 980mm wide multi-walled sheets (650N/m ² snow load & pitch 5°) | | | | | | | | |
|--|-------------------|--------|-------------------|--------|--------|-------------------|---------|---------|
| Width 'B' (in mm) → ↓ Depth 'D' (in mm) | 3000 | 4000 | 5000 | 6000 | 7000 | 8000 | 9000 | 10000 |
| 2500 (2359mm support excl.) | € 2186 | € 2623 | € 3321 | € 3661 | € 4095 | € 4742 | € 5176 | € 6174 |
| #m ² sheets | 7.4 | 9.8 | 12.3 | 14.7 | 17.2 | 19.6 | 22.1 | 24.5 |
| 3000 (2859mm support excl.) | € 2343 | € 2817 | € 3553 | € 3930 | € 4404 | € 5086 | € 6088 | € 6593 |
| #m ² sheets | 8.8 | 11.8 | 14.7 | 17.6 | 20.6 | 23.5 | 26.5 | 29.4 |
| 3500 (3359mm support excl.) | € 2499 | € 3012 | € 3685 | € 4199 | € 4708 | € 5430 | € 6467 | € 6710 |
| #m ² sheets | 10.3 | 13.7 | 17.2 | 20.6 | 24.0 | 27.4 | 30.9 | 34.3 |
| 4000 (3859mm support excl.) | € 2656 | € 3469 | € 3917 | € 4467 | € 5016 | € 6303 | € 6850 | € 7128 |
| #m ² sheets | 11.8 | 15.7 | 19.6 | 23.5 | 27.4 | 31.4 | 35.3 | 39.2 |
| 4500 (4359mm support excl.) | € 3174 | € 4114 | € 4687 | € 5364 | € 6037 | € 7452 | € 7759 | € 8529 |
| #m ² sheets | 13.2 | 17.6 | 22.1 | 26.5 | 30.9 | 35.3 | 40.0 | 44.1 |
| 5000 (4859mm support excl.) | € 4777 | € 6117 | € 7092 | € 8169 | € 9245 | € 11059 | € 11770 | € 12938 |
| #m ² sheets | 14.7 | 19.6 | 24.5 | 29.4 | 34.3 | 39.2 | 44.0 | 49.0 |
| 5500 (5359mm support excl.) | € 4990 | € 6383 | € 7411 | € 8540 | € 9669 | € 11536 | € 12301 | € 13522 |
| #m ² sheets | 17.6 | 23.5 | 29.4 | 35.3 | 41.2 | 47.0 | 53.0 | 58.8 |
| Supports | 2 supports | | 3 supports | | | 4 supports | | |

Please note: these prices are indicative and not binding!

NEW

If necessary, the reinforcement profiles will be delivered with your order.

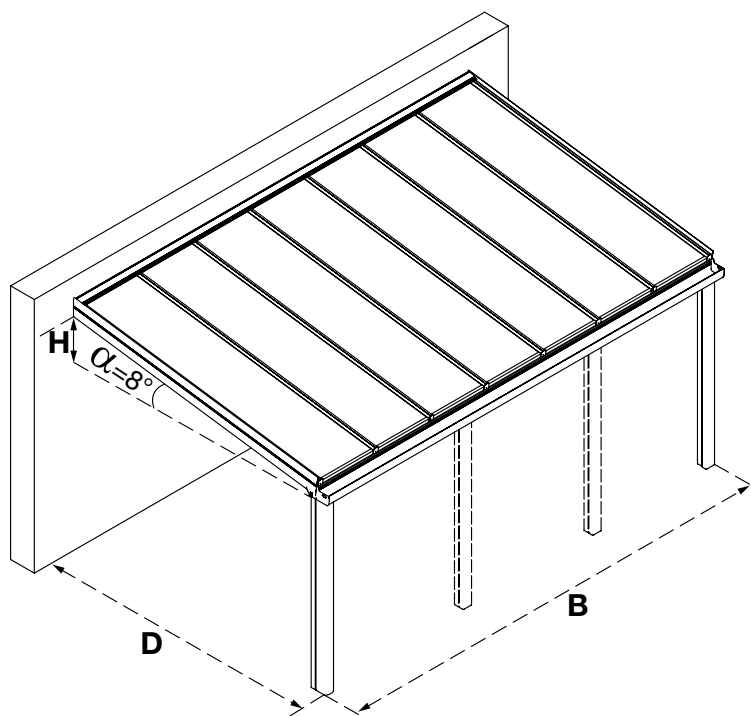

For glass without roof overhang

| CLIMALUX CLASSIC prepared for 8mm LSG (850N/m ² snow load & pitch 5°) | | | | | | | | |
|--|--------------------------------------|-------------------|--------|--------|-------------------|---------|---------|---------|
| Width 'B' (in mm) → ↓ Depth 'D' (in mm) | 3000 | 4000 | 5000 | 6000 | 7000 | 8000 | 9000 | 10000 |
| 2500 (2359mm support excl.) | € 2464 | € 3399 | € 3723 | € 4150 | € 4667 | € 6075 | € 6499 | € 6623 |
| #m ² glass panels | 6.9 | 9.2 | 11.6 | 13.9 | 16.3 | 18.6 | 20.9 | 23.3 |
| 3000 (2859mm support excl.) | € 2658 | € 3668 | € 4032 | € 4494 | € 5051 | € 6534 | € 6634 | € 7156 |
| #m ² glass panels | 8.3 | 11.1 | 14.0 | 16.8 | 19.7 | 22.5 | 25.3 | 28.2 |
| 3500 (3359mm support excl.) | € 2852 | € 3937 | € 4337 | € 4838 | € 5958 | € 6988 | € 7128 | € 7685 |
| #m ² glass panels | 9.8 | 13.0 | 16.4 | 19.8 | 23.1 | 26.4 | 29.7 | 33.1 |
| 4000 (3859mm support excl.) | € 3045 | € 4109 | € 4645 | € 5181 | € 6341 | € 7207 | € 7621 | € 9010 |
| #m ² glass panels | 11.2 | 15.0 | 18.8 | 22.7 | 26.5 | 30.3 | 34.1 | 37.9 |
| 4500 (4359mm support excl.) | € 3690 | € 5006 | € 5665 | € 6330 | € 7613 | € 8731 | € 9273 | € 10786 |
| #m ² glass panels | 12.6 | 16.8 | 21.1 | 25.4 | 29.7 | 33.9 | 38.2 | 42.6 |
| 5000 (4859mm support excl.) | € 5693 | € 7810 | € 8873 | € 9937 | € 11624 | € 13544 | € 14485 | € 16401 |
| #m ² glass panels | 14.0 | 18.7 | 23.5 | 28.3 | 33.1 | 37.8 | 42.6 | 47.4 |
| 5500 (5359mm support excl.) | Only possible with more glass panels | | | | | | | |
| #m ² glass panels | | | | | | | | |
| Supports | 2 supports | 3 supports | | | 4 supports | | | |
| # of glass panels | 4 | 6 | 7 | 8 | 9 | 11 | 12 | 13 |

Please note: these prices are indicative and not binding!

Roof systems with glass and sandwich panels are now also available with a slope of 2. Prices can be calculated on request with Climafast.

| Optional | | | | | |
|-------------------------------------|------|-------|-------|-------|-------|
| | (mm) | 3500 | 5000 | 6000 | 7000 |
| Softline gutter attachment GLX | | € 266 | € 379 | € 454 | € 529 |
| | (mm) | 2500 | 3250 | 5000 | 6500 |
| Surcharge/post for post 150 x 150mm | | € 210 | € 262 | | |

NEW

If necessary, the reinforcement profiles will be delivered with your order.

Quick calculator Climalux without roof overhang freestanding roof

A Climalux roof system can also be installed as a freestanding patio roof instead of against a wall. A freestanding patio roof does not need any supporting walls and can be placed anywhere in your garden. As with all Climalux systems, the detached version combines with plastic sheets (16 or 32mm) or glass. To guarantee the stability of a freestanding patio roof, the posts must be concreted into the ground according to our instructions.

For 16mm sheets without roof overhang – freestanding

| CLIMALUX CLASSIC FREESTANDING prepared for 16mm thick and 980mm wide multi-walled sheets (650N/m ² snow load & 5° pitch) | | | | | |
|---|------------------------|---------------|------------------------|----------------|------------------------|
| Width 'B' (in mm) → ↓ Depth 'D' (in mm) | 3000 | 4000 | 5000 | 6000 | 7000 |
| 2500 (2240mm support excl.) | € 4410 | € 5082 | € 5780 | € 6532 | € 7121 |
| #m ² sheets | 6.8 | 9.3 | 11.7 | 13.7 | 16.1 |
| 3000 (2740mm support excl.) | € 4659 | € 5378 | € 6117 | € 6903 | € 7540 |
| #m ² sheets | 8.8 | 11.7 | 14.7 | 17.6 | 20.5 |
| 3500 (3240mm support excl.) | € 4818 | € 5573 | € 6501 | € 7173 | € 7845 |
| #m ² sheets | 10.2 | 13.7 | 17.1 | 20.5 | 23.5 |
| 4000 (3740mm support excl.) | € 5193 | € 5987 | € 6953 | € 7662 | € 8374 |
| #m ² sheets | 11.7 | 15.6 | 19.6 | 23.5 | 27.4 |
| 4500 (4240mm support excl.) | € 5626 | € 6726 | € 7472 | € 8225 | € 9344 |
| #m ² sheets | 13.2 | 17.6 | 22.0 | 26.4 | 30.8 |
| 5000 (4740mm support excl.) | € 6107 | € 7331 | € 8199 | € 9074 | € 10316 |
| #m ² sheets | 14.7 | 19.6 | 24.5 | 29.4 | 34.3 |
| 5500 (5240mm support excl.) | € 7955 | € 9594 | € 10876 | € 12163 | € 13820 |
| #m ² sheets | 17.6 | 23.5 | 29.4 | 35.2 | 41.1 |
| front posts VS back posts | 2 & 2 posts | | 3 & 2 posts | | 3 & 3 posts |

Please note: these prices are indicative and not binding!

The front posts below the gutter are 110 x 141mm. The back posts below the GDZ are 110 x 110mm.

All posts must be concreted into the ground at least 40cm deep.

Surcharge for posts of 150 x 150mm (instead of 110 x 141mm): + € 244 gross per post.

NEW

If necessary, the reinforcement profiles will be delivered with your order.

We also offer Climalux with roof overhang. Please feel free to contact Skylux for any information. You can find the order form on page 106.

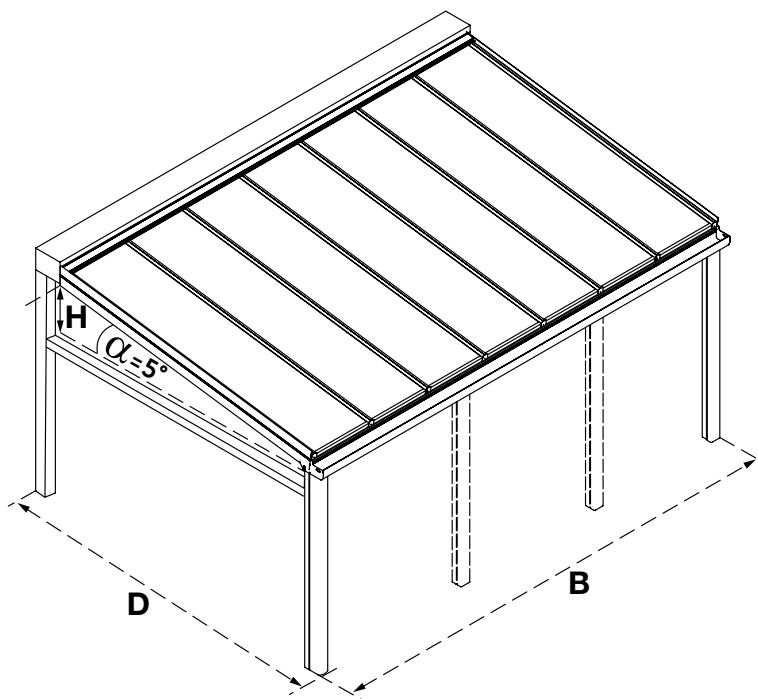

For glass without roof overhang – freestanding

| CLIMALUX CLASSIC FREESTANDING prepared for 8mm LSG (850N/m ² snow load & 5° pitch) | | | | | |
|---|--------------------------------------|-----------------|-----------------|-----------------|-----------------|
| Width 'B' (in mm) → ↓ Depth 'D' (in mm) | 3000 | 4000 | 5000 | 6000 | 7000 |
| 2500 (2240mm support excl.) #m ² glass panels | € 4676 6.4 | € 5858 8.6 | € 6426 10.8 | € 7013 13.1 | € 7939 15.3 |
| 3000 (2740mm support excl.) #m ² glass panels | € 4973 7.9 | € 6230 10.5 | € 6846 13.3 | € 7467 16.0 | € 8430 18.7 |
| 3500 (3240mm support excl.) #m ² glass panels | € 5168 9.3 | € 6499 12.4 | € 7150 15.7 | € 7811 18.9 | € 8812 22.1 |
| 4000 (3740mm support excl.) #m ² glass panels | € 5582 10.7 | € 7143 14.4 | € 7679 18.1 | € 8622 21.8 | € 9944 25.4 |
| 4500 (4240mm support excl.) #m ² glass panels | € 6466 12.2 | € 8279 16.3 | € 8938 20.5 | € 10128 24.7 | € 11574 28.8 |
| 5000 (4740mm support excl.) #m ² glass panels | € 8468 13.6 | € 11084 18.2 | € 12147 22.9 | € 13735 27.6 | € 15585 32.2 |
| 5500 (5240mm support excl.) #m ² glass panels | Only possible with more glass panels | | | | |
| front posts VS back posts | 2/2 posts | 3/2 posts | | 3/3 posts | |
| # of glass panels | 4 | 6 | 7 | 8 | 9 |

Please note: these prices are indicative and not binding!

The front posts below the gutter are 110 x 141mm. The back posts below the GDV are 110 x 110mm.

All posts must be concreted into the ground at least 40cm deep.

Surcharge for posts of 150 x 150mm (instead of 110 x 141mm): + € 244 gross per post.

Roof systems with glass and sandwich panels are now also available with a slope of 2. Prices can be calculated on request with Climafast.

| Optional | | | | | |
|--------------------------------|------|-------|-------|-------|-------|
| | (mm) | 3500 | 5000 | 6000 | 7000 |
| Softline gutter attachment GLX | | € 269 | € 382 | € 457 | € 532 |

NEW If necessary, the reinforcement profiles will be delivered with your order.

Quick calculator Climalux standard roofs without roof overhang

The following standard sizes have already been prepacked and are available from stock within about a week after the order date.

Please note: these prices are indicative and not binding!

Climalux standard roofs for sheets

| CLIMALUX CLASSIC prepared for 16mm thick and 980mm wide multi-walled sheets* (350N/m ² snow load & pitch 8°) | | | | |
|---|-------------------|-------------------|------------------|------------------|
| Width 'B' (in mm) → ↓ Depth 'D' (in mm) | 4000 | 5000 | 6000 | 7000 |
| 2859 (3000mm support incl.) | € 2809.11 | € 3459.57 | € 3948.99 | € 4428.91 |
| Items° RAL 7016 ST | 41329 | 41331 | 41333 | 48287 |
| Items° RAL 9010 | 41330 | 41332 | 41334 | 48288 |
| 3359 (3500mm support incl.) | € 3015 | € 3705 | € 4233.63 | € 4753.37 |
| Items° RAL 7016 ST | 41335 | 41337 | 41339 | 48289 |
| Items° RAL 9010 | 41336 | 41338 | 41340 | 48290 |
| 3859 (4000mm support incl.) | € 3219.08 | € 3949.19 | € 4518.26 | € 5077.83 |
| Items° RAL 7016 ST | 41341 | 41343 | 41345 | 48291 |
| Items° RAL 9010 | 41342 | 41344 | 41346 | 48292 |
| Supports (included) | 2 supports | 3 supports | | |

* plastic sheets are not included in the price

Climalux standard sets

| Description | Length (in mm) | Items° (RAL 7016 ST) | Items° (RAL 9010) | Price/box |
|---------------------------------------|----------------|-------------------------|----------------------|------------------|
| Rafter set (2 rafters/box) | 3000 | 36664 | 36660 | € 601.98 |
| Rafter set (3 rafters/box) | 3000 | 36665 | 36661 | € 902.97 |
| Rafter set (2 rafters/box) | 3500 | 36666 | 36662 | € 681.63 |
| Rafter set (3 rafters/box) | 3500 | 36667 | 36663 | € 1022.44 |
| Rafter set (2 rafters/box) | 4000 | 40983 | 40984 | € 761.28 |
| Rafter set (3 rafters/box) | 4000 | 40985 | 40986 | € 1141.92 |
| Side rafter set | 3000 | 36658 | 36656 | € 586.15 |
| (2 side rafters/box) | 3500 | 36659 | 36657 | € 671.66 |
| | 4000 | 40980 | 40981 | € 757.17 |
| Wall connection and gutter set | 4000 | 36653 | 36650 | € 901.15 |
| | 5000 | 36654 | 36651 | € 1085.22 |
| | 6000 | 36655 | 36652 | € 1260.72 |
| | 7000 | 48277 | 48276 | € 1426.70 |
| Support set (1 support/box) | 2500 | 36670 | 36668 | € 159.09 |
| Support set (2 supports/box) | 2500 | 36671 | 36669 | € 318.19 |
| Support set (1 support/box) | 3250 | 48437 | 48435 | € 200.60 |
| Support set (2 supports/box) | 3250 | 48438 | 48436 | € 401.20 |
| Sheets accessories set | 4000 | 48279 | 48280 | € 94.02 |
| | 5000 | 48281 | 48282 | € 106.96 |
| | 6000 | 48283 | 48284 | € 119.90 |
| | 7000 | 48285 | 48286 | € 132.84 |

For example: a standard Climalux roof 4000 x 3000 in RAL7016 structure (item 41329) consists of: 1x item 36665, 1x 36658, 1x item 36653, 1x item 36671 & 1x item 48279

Optional Climaled lighting

ATTENTION! If glass is used, we also recommend ordering the optional L432 profile as glass cover on the gutter + silicone glue.

Set contents

| | |
|--------------------------------|---|
| Rafter set | rafter DX aluminium clips CL16 spacer AX rubber pieces tampers |
| Side rafter set | rafter DX side clips CLLX spacer AX rubber pieces tampers |
| Wall connection and gutter set | wall connection section MX classic gutter profile GX wall rubber drainpipe screws and nail anchors drain support and bends gutter and wall fittings touch up paint pen |
| Support set | support post PX (110 x 141 x 2500/3250mm) U-top/bottom |
| Accessories set | tapes BB16 and BT16 silicone aluminium sealing profile U16 |

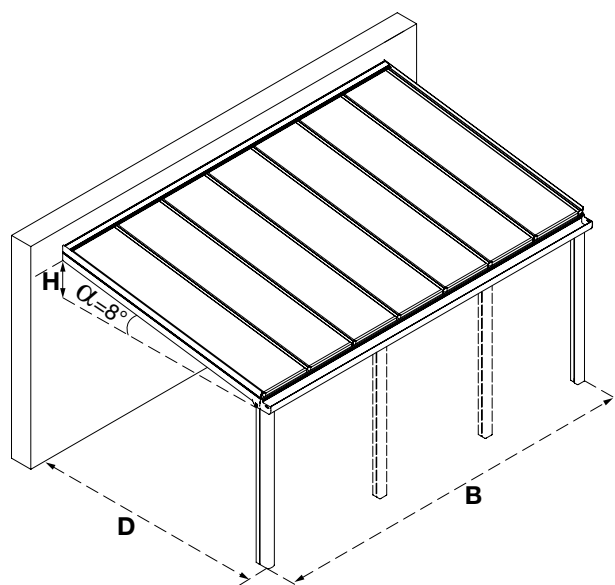

INFO:

- * Max. deflection of the profiles: 1/200
- * Delivery time: approx. 1 week

Assembly data (only for standard roofs)

| ↓ Depth (D) (in mm) | Width (B) (in mm) → | 4000 | 5000 | 6000 | 7000 |
|--|---------------------|-------------------|-------------------|-------------------|--------------------|
| 3000 (2859mm support excl.) | Δ H | 400 | 400 | 400 | 400 |
| | Sheet length | 2919 | 2919 | 2919 | 2919 |
| | Sheet width | 2 x 980 + 2 x 946 | 3 x 980 + 2 x 945 | 4 x 980 + 2 x 944 | 5 x 980 + 2 x 943 |
| | AX profile | 4 x 942 + 4 x 908 | 6 x 942 + 4 x 907 | 8 x 942 + 4 x 906 | 10 x 942 + 4 x 905 |
| 3500 (3359mm support excl.) | Δ H | 470 | 470 | 470 | 470 |
| | Sheet length | 3424 | 3424 | 3424 | 3424 |
| | Sheet width | 2 x 980 + 2 x 946 | 3 x 980 + 2 x 945 | 4 x 980 + 2 x 944 | 5 x 980 + 2 x 943 |
| | AX profile | 4 x 942 + 4 x 908 | 6 x 942 + 4 x 907 | 8 x 942 + 4 x 906 | 10 x 942 + 4 x 905 |
| 4000 (3859mm support excl.) | Δ H | 540 | 540 | 540 | 540 |
| | Sheet length | 3929 | 3929 | 3929 | 3929 |
| | Sheet width | 2 x 980 + 2 x 946 | 3 x 980 + 2 x 945 | 4 x 980 + 2 x 944 | 5 x 980 + 2 x 943 |
| | AX profile | 4 x 942 + 4 x 908 | 6 x 942 + 4 x 907 | 8 x 942 + 4 x 906 | 10 x 942 + 4 x 905 |

SELF-SUPPORTING NON-THERMAL PROFILE SYSTEM (cold roof)

CLIMALUX HORIZON

- Sleek and contemporary design
- A wide view at an affordable price
- Span length of up to 6 metres depending on the snow load, depth and chosen glazing
- No visible screws and bolts on the outside

Climalux Horizon is made to fit and easy to install. The profile system is self-supporting thanks to the integration of the GXLX gutter. Span lengths up to 6 metres are possible, depending on the snow load, depth and glazing.

Example: the span length measures 5 metres for a glass roof of 4 metres deep with a snow load of 850N/m². The patio roof can be even wider if you choose a smaller depth or plastic sheets.

The roof slope varies between 2° and 10° and starting from 5° with multi-walled sheets and is fitted for single glazing (8 or 10mm) or 16 or 32mm plastic sheets. Combining the Climalux Horizon with a roof overhang or Climacrown is not possible.

Having no intermediate posts, the budget-friendly Climalux Horizon offers you a great and undisturbed garden view. Additionally, the profile system itself has a sleek and contemporary design (no visible screws or bolts on the outside, modern looking gutter and post, fitted sealing plates, etc.).

- 2 standard RAL colours: white RAL 9010 & anthracite grey RAL 7016 ST. Delivery time: max. 3 weeks.
- 9 “trend” RAL colours: cream white RAL 9001, black RAL 9005 ST, white aluminium RAL 9006 ST, grey aluminium RAL 9007 ST, RAL 9009 ST, RAL 9010 ST, purple red RAL 3004 ST, RAL 7039 ST & RAL 8014 ST. Fixed surcharge: € 200 net. Delivery time: max. 4 weeks.
- Other RAL colours: see p. 8 & 9 (price on request). Delivery time: max. 4 weeks.



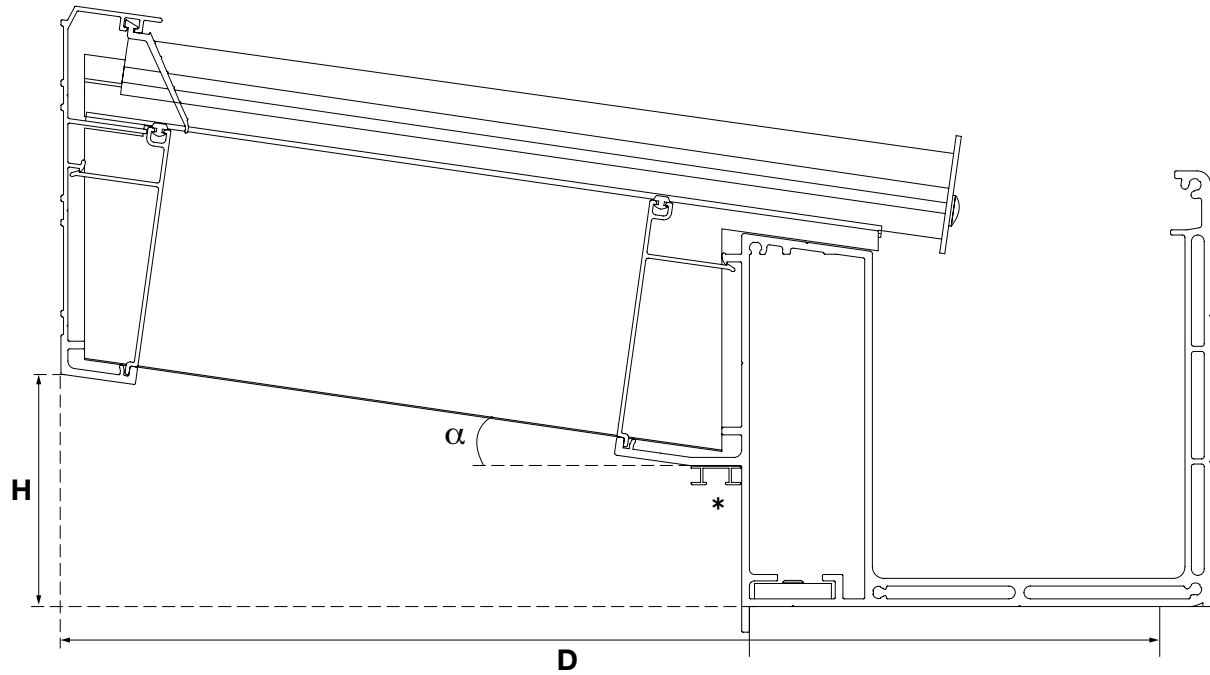

* LED Stripes as an option

Options

- Width B: ∞
- Depth D: max. 5677mm
- The roof pitch α varies between 2° and 10° and starting from 5° with multi-walled sheets

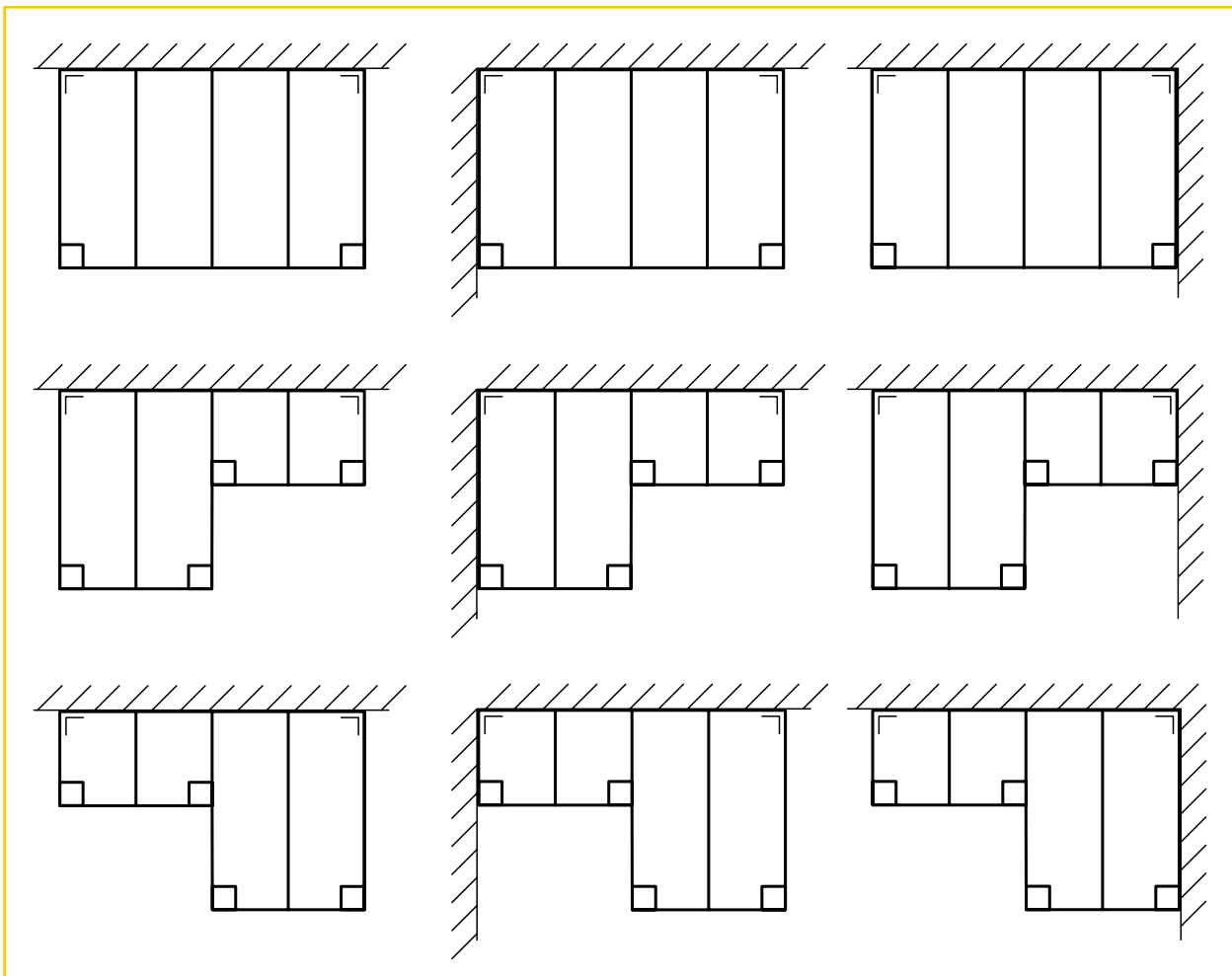

Quick calculator Climalux Horizon

Info:

- Aluminium profile system with XL gutter and aluminium clips
- 2 or 3 posts are included in the price
- Two-piece posts 150 x 177 x 2500mm, drainpipe and accessories are included
- 2 standard RAL colours: white RAL 9010 & anthracite RAL 7016 ST – delivery time: max. 3 weeks
- 9 “trend” RAL colours: cream white RAL 9001, black RAL 9005 ST, white aluminium RAL 9006 ST, grey aluminium RAL 9007 ST, RAL 9009 ST (DB703), RAL 9010 ST, purple red RAL 3004 ST, RAL 7039 ST & RAL 8014 ST – surcharge: € 200 net – delivery time: max. 4 weeks
- Other RAL colours: see p. 8 & 9 (price on request) – delivery time: max. 4 weeks
- Plastic sheets or glass not included in the price
- Maximum deflection of the profiles: 1/200

Calculate the price as follows:

- Measure the roof’s width B (mm) and depth D (mm).
- Select the next size up in the table and read off the prices of the profiles.
- Multiply the sheet or glass area, indicated in the same box, by the price/m² of the sheet or the glass (not supplied by Skylux).

For 16mm plastic sheets

| CLIMALUX HORIZON prepared for 16mm thick and 980mm wide multi-walled sheets (650N/m ² snow load & pitch 5°) | | | | | | | | |
|--|-------------------|----------------|----------------|----------------|-------------------|-----------------|-----------------|-----------------|
| Width 'B' (in mm) → ↓ Depth 'D' (in mm) | 3000 | 4000 | 5000 | 6000 | 7000 | 8000 | 9000 | 10000 |
| 2500 (2323mm support excl.) #m ² sheets | € 3053 7.4 | € 3368 9.8 | € 3863 12.3 | € 4357 14.7 | € 4852 17.2 | € 5986 19.6 | € 6481 22.1 | € 7006 24.5 |
| 3000 (2823mm support excl.) #m ² sheets | € 3210 8.8 | € 3562 11.8 | € 4094 14.7 | € 4626 17.6 | € 5158 20.6 | € 6330 23.5 | € 6862 26.5 | € 7425 29.4 |
| 3500 (3323mm support excl.) #m ² sheets | € 3367 10.3 | € 3756 13.7 | € 4326 17.2 | € 4895 20.6 | € 5958 24.0 | € 6674 27.4 | € 7244 30.9 | € 7844 34.3 |
| 4000 (3823mm support excl.) #m ² sheets | € 3524 11.8 | € 3949 15.7 | € 4556 19.6 | € 5163 23.5 | € 6263 27.4 | € 7017 31.4 | € 7624 35.3 | € 8262 39.2 |
| 4500 (4323mm support excl.) #m ² sheets | € 4042 13.2 | € 4596 17.6 | € 5328 22.1 | € 6060 26.5 | € 7287 30.9 | € 8166 35.3 | € 8899 39.7 | € 9662 44.1 |
| 5000 (4823mm support excl.) #m ² sheets | € 5645 14.7 | € 6599 19.6 | € 7733 24.5 | € 8868 29.4 | € 10408 34.3 | € 11776 39.2 | € 12907 44.1 | € 14071 49.0 |
| 5500 (5323mm support excl.) #m ² sheets | € 5855 17.6 | € 6865 23.5 | € 8049 29.4 | € 9551 35.3 | € 10829 41.2 | € 12253 47.0 | € 13438 52.9 | € 14658 58.8 |
| Supports (included) | 2 supports | | | | 3 supports | | | |

Please note: these prices are indicative and not binding!

NEW If necessary, the reinforcement profiles will be delivered with your order.

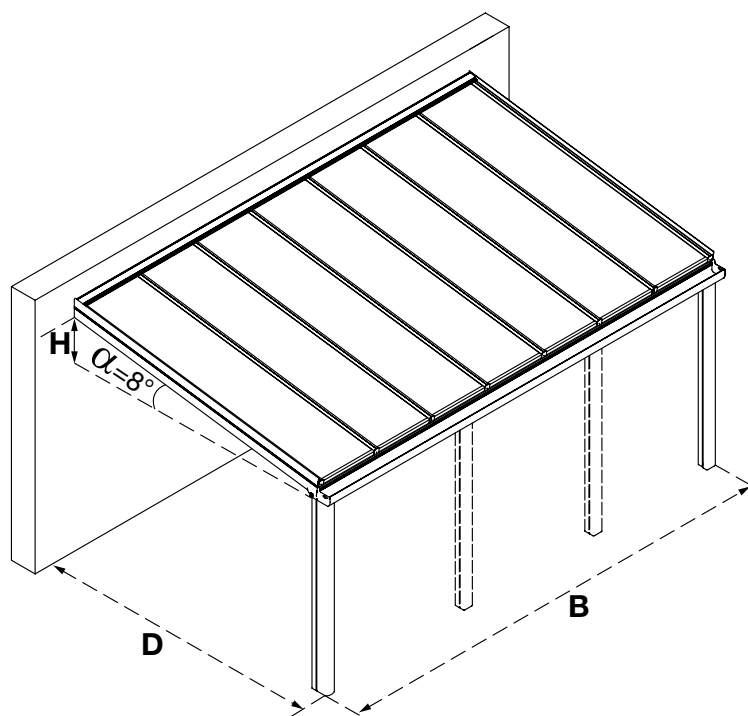

For glass

| CLIMALUX HORIZON prepared for 8mm LSG (850N/m ² snow load & pitch 5°) | | | | | | | | |
|--|--------------------------------------|--------|--------|---------|------------|---------|---------|---------|
| Width 'B' (in mm) → ↓ Depth 'D' (in mm) | 3000 | 4000 | 5000 | 6000 | 7000 | 8000 | 9000 | 10000 |
| 2500 (2323mm support excl.) | € 3330 | € 3883 | € 4364 | € 4846 | € 5912 | € 6796 | € 7277 | € 7759 |
| #m ² glass panels | 6.9 | 9.2 | 11.6 | 13.9 | 16.3 | 18.6 | 20.9 | 23.3 |
| 3000 (2823mm support excl.) | € 3524 | € 4151 | € 4670 | € 5190 | € 6210 | € 7252 | € 7771 | € 8290 |
| #m ² glass panels | 8.3 | 11.1 | 14.0 | 16.8 | 19.7 | 22.5 | 25.3 | 28.2 |
| 3500 (3323mm support excl.) | € 3719 | € 4421 | € 4978 | € 5844 | € 6592 | € 7709 | € 8265 | € 8822 |
| #m ² glass panels | 9.8 | 13.0 | 16.4 | 19.8 | 23.1 | 26.4 | 29.7 | 33.1 |
| 4000 (3823mm support excl.) | € 3912 | € 4689 | € 5283 | € 6187 | € 6972 | € 8164 | € 8758 | € 9352 |
| #m ² glass panels | 11.2 | 15.0 | 18.8 | 22.7 | 26.5 | 30.3 | 34.1 | 37.9 |
| 4500 (4323mm support excl.) | € 4558 | € 5586 | € 6306 | € 7336 | € 8248 | € 9691 | € 10410 | € 11130 |
| #m ² glass panels | 12.5 | 16.7 | 21.0 | 25.3 | 29.6 | 33.8 | 38.1 | 42.4 |
| 5000 (4823mm support excl.) | € 6561 | € 8394 | € 9515 | € 11041 | € 12255 | € 14500 | € 15621 | € 16742 |
| #m ² glass panels | 14.0 | 18.6 | 23.4 | 28.2 | 33.0 | 37.7 | 42.4 | 47.2 |
| 5500 (5323mm support excl.) | Only possible with more glass panels | | | | | | | |
| Supports (included) | 2 supports | | | | 3 supports | | | |
| # of glass panels | 4 | 6 | 7 | 8 | 9 | 11 | 12 | 13 |

Please note: these prices are indicative and not binding!

Roof systems with glass are now also available with a slope of 2°. Prices can be calculated on request with Climafast.

NEW

If necessary, the reinforcement profiles will be delivered with your order.

Quick calculator Climalux Horizon freestanding roof

A Climalux Horizon roof system can also be installed as a freestanding patio roof instead of against a wall. A freestanding patio roof does not need any supporting walls and can be placed anywhere in your garden. As with all Climalux systems, the detached version combines with plastic sheets (16 or 32mm) or glass. To guarantee the stability of a freestanding patio roof, the posts must be concreted into the ground according to our instructions.

For 16mm plastic sheets – freestanding

| CLIMALUX HORIZON FREESTANDING prepared for 16mm thick and 980mm wide multi-walled sheets (650N/m ² snow load & 5° pitch) | | | | | |
|---|------------------------|---------------|----------------|----------------|------------------------|
| Width 'B' (in mm) → ↓ Depth 'D' (in mm) | 3000 | 4000 | 5000 | 6000 | 7000 |
| 2500 (2213mm support excl.) | € 4797 | € 5347 | € 5839 | € 6496 | € 7143 |
| #m ² sheets | 6.8 | 9.3 | 11.7 | 13.7 | 16.1 |
| 3000 (2713mm support excl.) | € 5046 | € 5644 | € 6176 | € 6868 | € 7563 |
| #m ² sheets | 8.8 | 11.7 | 14.7 | 17.6 | 20.5 |
| 3500 (3213mm support excl.) | € 5206 | € 5838 | € 6405 | € 7137 | € 8360 |
| #m ² sheets | 10.2 | 13.7 | 17.1 | 20.5 | 23.5 |
| 4000 (3713mm support excl.) | € 5819 | € 6491 | € 7098 | € 7865 | € 9128 |
| #m ² sheets | 11.7 | 15.6 | 19.6 | 23.5 | 27.4 |
| 4500 (4213mm support excl.) | € 6014 | € 6728 | € 7376 | € 8190 | € 9859 |
| #m ² sheets | 13.2 | 17.6 | 22.0 | 26.4 | 30.8 |
| front posts VS back posts | 2 & 2 posts | | | | 2 & 3 posts |
| 5000 (4713mm support excl.) | € 6494 | € 7333 | € 8105 | € 9038 | € 10775 |
| #m ² sheets | 14.7 | 19.6 | 24.5 | 29.4 | 34.3 |
| 5500 (5213mm support excl.) | € 8343 | € 9596 | € 10783 | € 12127 | € 14279 |
| #m ² sheets | 17.6 | 23.5 | 29.4 | 35.2 | 41.1 |
| front posts VS back posts | 2 & 2 posts | | | | 3 & 3 posts |

Please note: these prices are indicative and not binding!

The front posts below the gutter are 150 x 177mm. The back posts below the GDX are 110 x 110mm. All posts must be concreted into the ground at least 40cm deep.

NEW

If necessary, the reinforcement profiles will be delivered with your order.

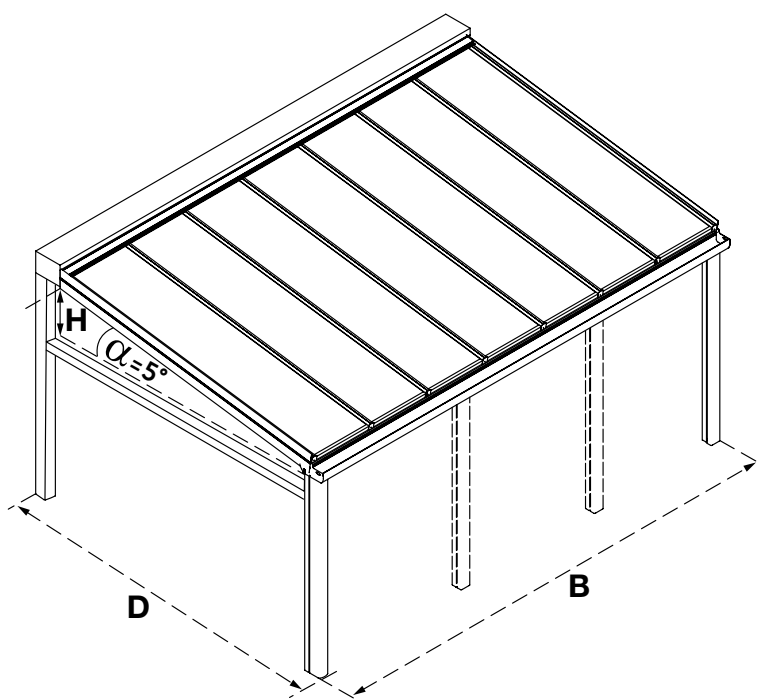

For glass – freestanding

| CLIMALUX HORIZON FREESTANDING prepared for 8mm LSG (850N/m ² snow load & pitch 5°) | | | | | |
|---|-------------|---------|---------|-------------|-------------|
| Width 'B' (in mm) → ↓ Depth 'D' (in mm) | 3000 | 4000 | 5000 | 6000 | 7000 |
| 2500 (2213mm support excl.) | € 5063 | € 5861 | € 6332 | € 6977 | € 8449 |
| #m ² glass panels | 6.5 | 8.6 | 10.8 | 13.1 | 15.3 |
| front posts VS back posts | 2 & 2 posts | | | 2 & 3 posts | |
| 3000 (2713mm support excl.) | € 5360 | € 6233 | € 6752 | € 7431 | € 8888 |
| #m ² glass panels | 7.9 | 10.5 | 13.2 | 15.9 | 18.6 |
| 3500 (3213mm support excl.) | € 5554 | € 6502 | € 7056 | € 8086 | € 9270 |
| #m ² glass panels | 9.3 | 12.4 | 15.6 | 18.8 | 22.0 |
| 4000 (3713mm support excl.) | € 6207 | € 7230 | € 7824 | € 9253 | € 10229 |
| #m ² glass panels | 10.8 | 14.4 | 18.0 | 21.7 | 25.4 |
| 4500 (4213mm support excl.) | € 6853 | € 8127 | € 8844 | € 10402 | € 11504 |
| #m ² glass panels | 12.2 | 16.3 | 20.4 | 24.5 | 28.7 |
| front posts VS back posts | 2 & 2 posts | | | 2 & 3 posts | 3 & 3 posts |
| 5000 (4713mm support excl.) | € 8855 | € 10932 | € 12053 | € 14135 | € 15512 |
| #m ² glass panels | 13.6 | 18.2 | 22.8 | 27.3 | 32.0 |
| front posts VS back posts | 2 & 2 posts | | | 3 & 3 posts | |
| # of glass panels | 4 | 6 | 7 | 8 | 9 |

Please note: these prices are indicative and not binding!

The front posts below the gutter are 150 x 177mm. The back posts below the GDG are 110 x 110mm. All posts must be concreted into the ground at least 40cm deep.

Roof systems with glass and sandwich panels are now also available with a slope of 2°. Prices can be calculated on request with Climafast.

NEW

If necessary, the reinforcement profiles will be delivered with your order.

SELF-SUPPORTING NON-THERMAL PROFILE SYSTEM (cold roof)

CLIMACROWN ROOF (cold roof)

If you are drawn to the modern flat roof with the advantage of a sloping roof for water drainage, the Climacrown won't disappoint.

The Climacrown is based on the Climalux profiles, with a modular crown profile as an extra feature. The crown profile can be provided with LED lighting (optional).

This self-supporting profile system is completely made to size and is easily installed. The Climacrown roof can be provided with 16 or 32mm plastic sheets or glass of 8 or 10mm (not supplied by Skylux). Climacrown is preferably used with a pitch of 2° and starting from 5° with multi-walled sheets.

- 2 standard RAL colours: white RAL 9010 (code RWB964) and anthracite RAL 7016 ST (code 029/71334). Delivery time: max. 3 weeks.
- 9 "trend" RAL colours: cream white RAL 9001, black RAL 9005 ST, white aluminium RAL 9006 ST, grey aluminium RAL 9007 ST, RAL 9009 ST (DB703), RAL 9010 ST, purple red RAL 3004 ST, RAL 7039 ST & RAL 8014 ST. Surcharge: € 200 net. Delivery time: max. 4 weeks.
- Other RAL colours: see p. 8 & 9 (price on request). Delivery time: max. 4 weeks.



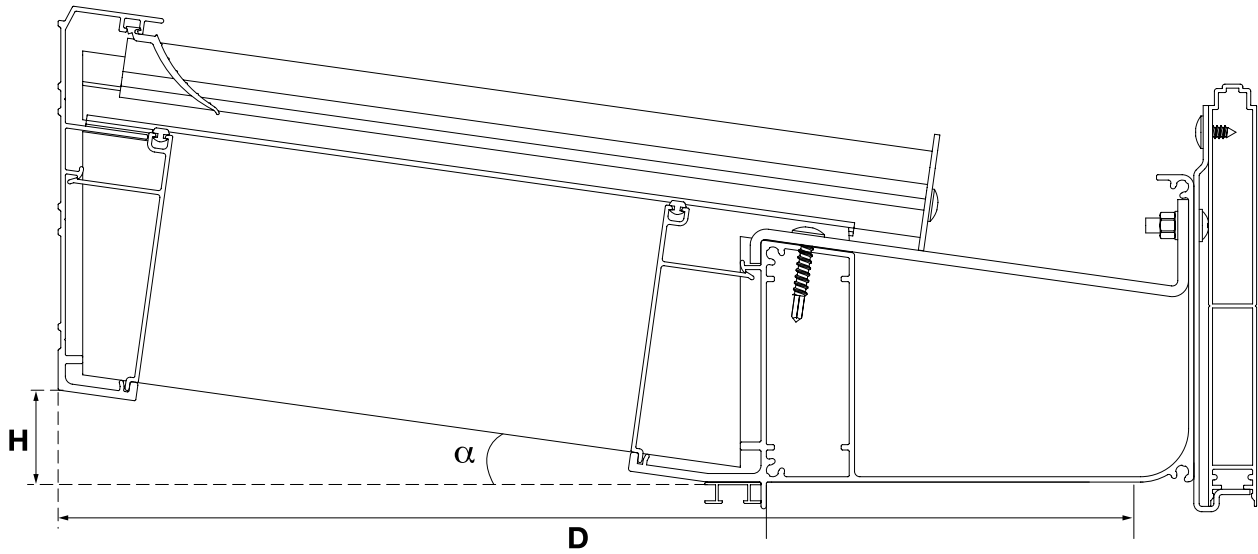

Options

- Width B: max. 7m
- Depth D: max. 4150mm
- Roof pitch α 2° and starting from 5° with multi-walled sheets

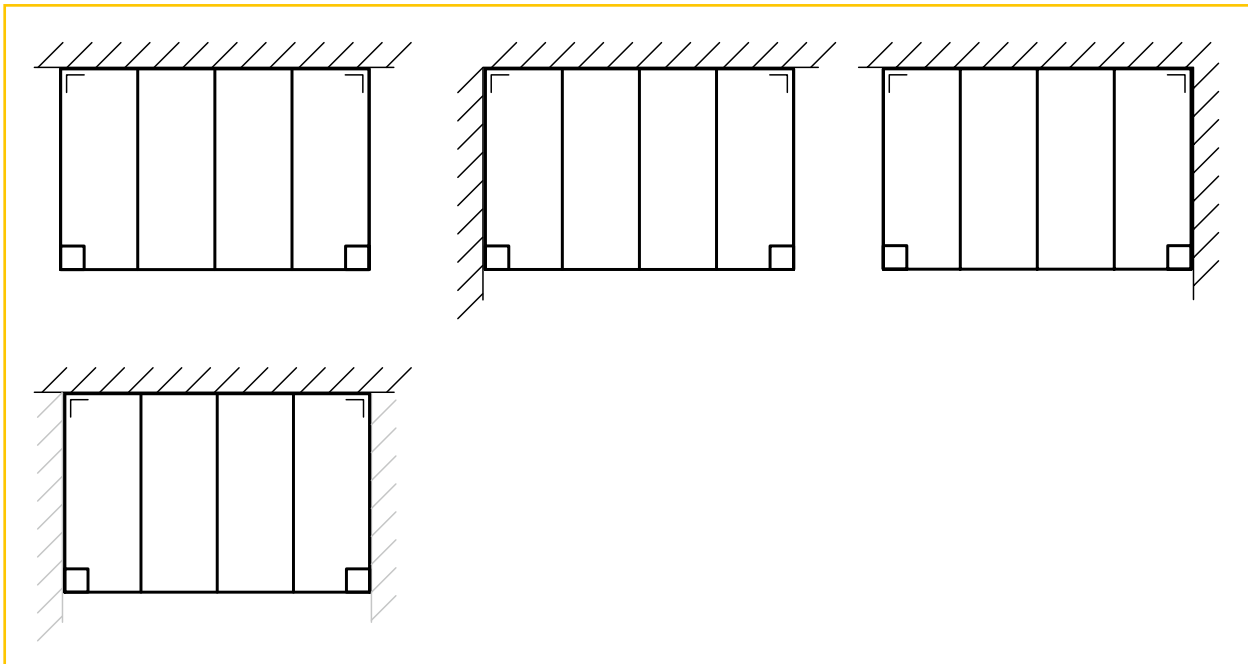

Quick calculator Climacrown

Info:

- Aluminium profile system with Classic gutter and aluminium push clips
- 2 or 3 posts 150 x 150 x 2500mm are included in the price
- Roof pitch 2° and starting from 5° with multi-walled sheets
- 2 standard RAL colours: white RAL 9010 (code RWB964) and anthracite grey RAL 7016 ST (code 029/71334) – delivery time: max. 3 weeks
- 9 “trend” RAL colours: cream white RAL 9001, black RAL 9005 ST, white aluminium RAL 9006 ST, grey aluminium RAL 9007 ST, RAL 9009 ST (DB703), RAL 9010 ST, purple red RAL 3004 ST, RAL 7039 ST & RAL 8014 ST – surcharge: € 200 net – delivery time: max. 4 weeks
- Other RAL colours: see p. 8 & 9 (price on request) – delivery time: max. 4 weeks
- Plastic sheets or glass not included in the price
- Maximum deflection of the profiles: 1/200
- Drainpipe and accessories included
- The crown profile is modular and the profiles are max. 7 meters long
- Height of the crown profile depends on the roof’s depth and is built in stages of 75mm
- We also deliver all profiles and assembly accessories
- There are no visible screws on the outside of the crown profile
- LED lighting can be provided in the Climacrown

Calculate the price as follows:

- Measure the roof’s width B (mm) and depth D (mm).
- Select the next size up in the table and read off the prices of the profiles.
- Multiply the sheet or glass area, indicated in the same box, by the price/m² of the sheet or the glass (not supplied by Skylux).

For 16mm sheets

| CLIMALUX with CLIMACROWN prepared for 16mm thick and 980mm wide multi-walled sheets (650N/m ² snow load & pitch 5°) | | | | | | |
|--|-------------------|-----------------|-------------------|-----------------|-----------------|-------------------|
| Width ‘B’ (in mm) → ↓ Depth ‘D’ (in mm) | 3000 | 4000 | 5000 | 6000 | 7000 | Climacrown height |
| 2500 (2350mm support excl.) #m ² sheets | € 3891 7.4 | € 4354 9.8 | € 5123 12.3 | € 5872 14.7 | € 6374 17.2 | 385mm |
| 3000 (2850mm support excl.) #m ² sheets | € 4380 8.8 | € 4917 11.8 | € 5681 14.7 | € 6530 17.6 | € 7030 20.6 | 460mm |
| 3500 (3350mm support excl.) #m ² sheets | € 4536 10.3 | € 5111 13.7 | € 6026 17.2 | € 6799 20.6 | € 7334 24.0 | 460mm |
| 4000 (3850mm support excl.) #m ² sheets | € 5341 11.8 | € 6292 15.7 | € 6979 19.6 | € 7840 23.5 | € 8416 27.4 | 535mm |
| 4500 (4350mm support excl.) #m ² sheets | € 5910 13.2 | € 7141 17.6 | € 7953 22.1 | € 8963 26.5 | € 9660 30.9 | 610mm |
| 5000 (4850mm support excl.) #m ² sheets | € 7513 14.7 | € 9145 19.6 | € 10358 24.5 | € 11768 29.4 | € 12869 34.3 | 610mm |
| 5500 (5350mm support excl.) #m ² sheets | € 9275 17.6 | € 10761 23.5 | € 12027 29.4 | € 13571 35.3 | € 14726 41.2 | 685mm |
| Supports (included) | 2 supports | | 3 supports | | | |

Please note: these prices are indicative and not binding!

NEW If necessary, the reinforcement profiles will be delivered with your order.

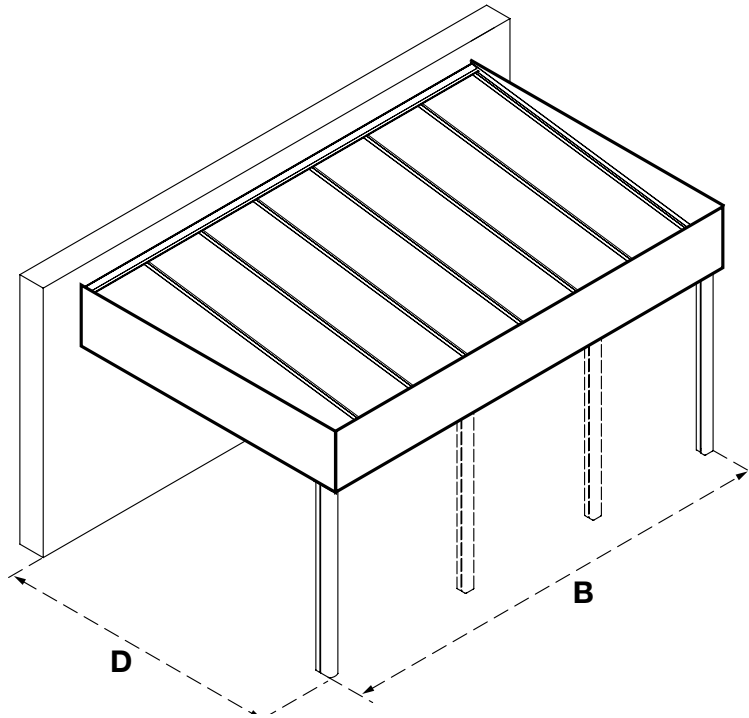

For glass

| CLIMALUX with CLIMACROWN prepared for 8mm LSG (850N/m ² snow load & pitch 5°) | | | | | | |
|--|-------------------|-----------------|-------------------|-----------------|-----------------|-------------------|
| Width 'B' (in mm) → ↓ Depth 'D' (in mm) | 3000 | 4000 | 5000 | 6000 | 7000 | Climacrown height |
| 2500 (2350mm support excl.) #m ² glass panels | € 3989 6.9 | € 5087 9.2 | € 5731 11.6 | € 6393 13.9 | € 6980 16.3 | 310mm |
| 3000 (2850mm support excl.) #m ² glass panels | € 4370 8.3 | € 5544 11.1 | € 6182 14.0 | € 6925 16.8 | € 7506 19.7 | 310mm |
| 3500 (3350mm support excl.) #m ² glass panels | € 4566 9.8 | € 5813 13.0 | € 6489 16.4 | € 7268 19.8 | € 8417 23.1 | 310mm |
| 4000 (3850mm support excl.) #m ² glass panels | € 4979 11.2 | € 6418 15.0 | € 7015 18.8 | € 7832 22.7 | € 9018 26.5 | 310mm |
| 4500 (4350mm support excl.) #m ² glass panels | € 6123 12.6 | € 7703 16.8 | € 8427 21.1 | € 9421 25.4 | € 10734 29.7 | 385mm |
| 5000 (4850mm support excl.) #m ² glass panels | € 8126 14.0 | € 10508 18.7 | € 11675 23.5 | € 13029 28.3 | € 14783 33.1 | 385mm |
| Supports (included) | 2 supports | | 3 supports | | | |
| # of glass panels | 4 | 6 | 7 | 8 | 9 | |

Please note: these prices are indicative and not binding!

Roof systems with glass and sandwich panels are now also available with a slope of 2°. Prices can be calculated on request with Climafast.

| Option: surcharge for version with LED lighting | | | | | | |
|---|-------|-------|-------|--------|--------|-------------------|
| Width 'B' (in mm) → ↓ Depth 'D' (in mm) | 3000 | 4000 | 5000 | 6000 | 7000 | Climacrown height |
| 2500 (2350mm support excl.) | € 703 | € 703 | € 796 | € 829 | € 880 | 385mm |
| 3000 (2850mm support excl.) | € 703 | € 721 | € 796 | € 847 | € 880 | 460mm |
| 3500 (3350mm support excl.) | € 721 | € 721 | € 814 | € 847 | € 898 | 460mm |
| 4000 (3850mm support excl.) | € 721 | € 739 | € 814 | € 865 | € 898 | 535mm |
| 4500 (4350mm support excl.) | € 889 | € 889 | € 982 | € 1015 | € 1066 | 610mm |

NEW

If necessary, the reinforcement profiles will be delivered with your order.

Quick calculator Climacrown freestanding roof

A Climacrown roof system can also be installed as a freestanding patio roof instead of against a wall. A freestanding patio roof does not need any supporting walls and can be placed anywhere in your garden. As with all Climalux systems, the detached version combines with plastic sheets (16 or 32mm) or glass. To guarantee the stability of a freestanding patio roof, the posts must be concreted into the ground according to our instructions.

For 16mm sheets – freestanding

| CLIMALUX WITH CLIMACROWN FREESTANDING prepared for 16mm thick and 980mm wide multi-walled sheets (650N/m ² snow load & 5° pitch) | | | | | | |
|---|-----------------|-----------------|-----------------|-----------------|-----------------|-------------------|
| Width 'B' (in mm) → ↓ Depth 'D' (in mm) | 3000 | 4000 | 5000 | 6000 | 7000 | Climacrown height |
| 2500 (2240mm support excl.) #m ² sheets | € 6155 6.8 | € 7151 9.3 | € 7874 11.7 | € 9079 13.7 | € 9693 16.1 | 385mm |
| 3000 (2740mm support excl.) #m ² sheets | € 6793 8.8 | € 7869 11.7 | € 8633 14.7 | € 9914 17.6 | € 10577 20.5 | 460mm |
| 3500 (3240mm support excl.) #m ² sheets | € 6953 10.2 | € 8064 13.7 | € 9017 17.1 | € 10184 20.5 | € 10881 23.5 | 460mm |
| 4000 (3740mm support excl.) #m ² sheets | € 8098 11.7 | € 9591 15.6 | € 10318 19.6 | € 11626 23.5 | € 12363 27.4 | 535mm |
| 4500 (4240mm support excl.) #m ² sheets | € 8532 13.2 | € 10066 17.6 | € 10837 22.1 | € 12189 26.5 | € 13333 30.9 | 610mm |
| 5000 (4740mm support excl.) #m ² sheets | € 9196 14.7 | € 10887 19.6 | € 11779 24.3 | € 13294 29.4 | € 14563 34.3 | 610mm |
| 5500 (5240mm support excl.) #m ² sheets | € 12518 17.6 | € 14748 23.5 | € 16056 29.4 | € 18145 35.2 | € 19828 41.1 | 685mm |
| front posts VS back posts | 2 & 2 posts | | 3 & 2 posts | | 3 & 3 posts | |

Please note: these prices are indicative and not binding!

The front posts below the gutter are 150 x 150mm. The back posts below the GDG are 110 x 110mm. All posts must be concreted into the ground at least 40cm deep.

NEW If necessary, the reinforcement profiles will be delivered with your order.

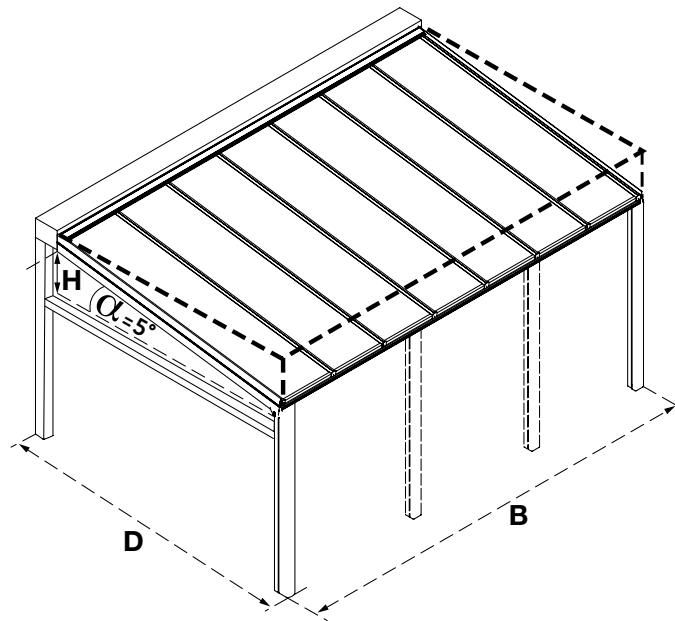

For glass – freestanding

| CLIMALUX WITH CLIMACROWN FREESTANDING prepared for 8mm LSG (850N/m ² snow load & 2° pitch) | | | | | | |
|--|------------------------|------------------------|------------------------|------------------------|------------------------|-------------------|
| Width 'B' (in mm) → ↓ Depth 'D' (in mm) | 3000 | 4000 | 5000 | 6000 | 7000 | Climacrown height |
| 2500 (2240mm support excl.) #m ² glass panels | € 6257 6.5 | € 7710 8.7 | € 8340 10.7 | € 9369 13.1 | € 10320 15.0 | 310mm |
| 3000 (2740mm support excl.) #m ² glass panels | € 6741 7.9 | € 8269 10.6 | € 8947 13.3 | € 10011 16.0 | € 10999 18.7 | 310mm |
| 3500 (3240mm support excl.) #m ² glass panels | € 6935 9.3 | € 8539 12.5 | € 9251 15.7 | € 10355 18.9 | € 11909 22.1 | 310mm |
| 4000 (3740mm support excl.) #m ² glass panels | € 7570 10.8 | € 9249 14.4 | € 10001 18.1 | € 11386 21.8 | € 12732 25.5 | 310mm |
| 4500 (4240mm support excl.) #m ² glass panels | € 8216 12.1 | € 10301 16.2 | € 11022 20.4 | € 12535 24.6 | € 14008 28.7 | 310mm |
| 5000 (4740mm support excl.) #m ² glass panels | € 10703 13.6 | € 13669 18.1 | € 14793 22.8 | € 16807 27.5 | € 18681 32.1 | 385mm |
| front posts VS back posts | 2 & 2 posts | 3 & 2 posts | 3 & 2 posts | 3 & 3 posts | 3 & 3 posts | |
| # of glass panels | 4 | 6 | 7 | 8 | 9 | |

Please note: these prices are indicative and not binding!

The front posts below the gutter are 150 x 150mm. The back posts below the GDX are 110 x 110mm. All posts must be concreted into the ground at least 40cm deep.

Roof systems with glass and sandwich panels are now also available with a slope of 2°. Prices can be calculated on request with Climafast.

- For the optional LED lighting: see page 84

| Option: surcharge for version with LED lighting | | | | | | |
|---|--------|--------|--------|--------|--------|-------------------|
| Width 'B' (in mm) → ↓ Depth 'D' (in mm) | 3000 | 4000 | 5000 | 6000 | 7000 | Climacrown height |
| 2500 (2240mm support excl.) | € 925 | € 943 | € 1111 | € 1195 | € 1279 | 385mm |
| 3000 (2740mm support excl.) | € 943 | € 961 | € 1129 | € 1213 | € 1297 | 460mm |
| 3500 (3240mm support excl.) | € 943 | € 961 | € 1129 | € 1213 | € 1297 | 460mm |
| 4000 (3740mm support excl.) | € 961 | € 979 | € 1147 | € 1231 | € 1297 | 535mm |
| 4500 (4240mm support excl.) | € 1111 | € 1129 | € 1297 | € 1381 | € 1465 | 535mm |

NEW If necessary, the reinforcement profiles will be delivered with your order.

SELF-SUPPORTING NON-THERMAL PROFILE SYSTEM (cold roof)

CLIMAX PANORAMA (cold roof)

Climax Panorama offers numerous possibilities as a self-supporting patio roof or canopy.

Thanks to the innovative GDG gutter profile, where the gutter and gutter support have been designed as a single unit, Climax Panorama is self-supporting up to 7m in width between two posts (with 16mm plastic sheets and a depth of 3m). This will give you an attractive 'panoramic look', without intermediate posts to spoil the view. It is self-supporting up to 6m in depth. The roof pitch varies between 2° and 20° and starting from 5° with multi-walled sheets.

- 2 standard RAL colours: white RAL 9010 & anthracite RAL 7016 ST. Delivery time: max. 3 weeks.
- 9 "trend" RAL colours: cream white RAL 9001, black RAL 9005 ST, white aluminium RAL 9006 ST, grey aluminium RAL 9007 ST, RAL 9009 ST (DB703), RAL 9010 ST, purple red RAL 3004 ST, RAL 7039 ST & RAL 8014 ST. Surcharge: € 200 net. Delivery time: max. 4 weeks.
- Other RAL colours: see p. 8 & 9 (price on request). Delivery time: max. 4 weeks.

Climaled can be provided in the Panorama gutter or below the rafter (see p. 84). This LED lighting emits a soft and pleasant light.



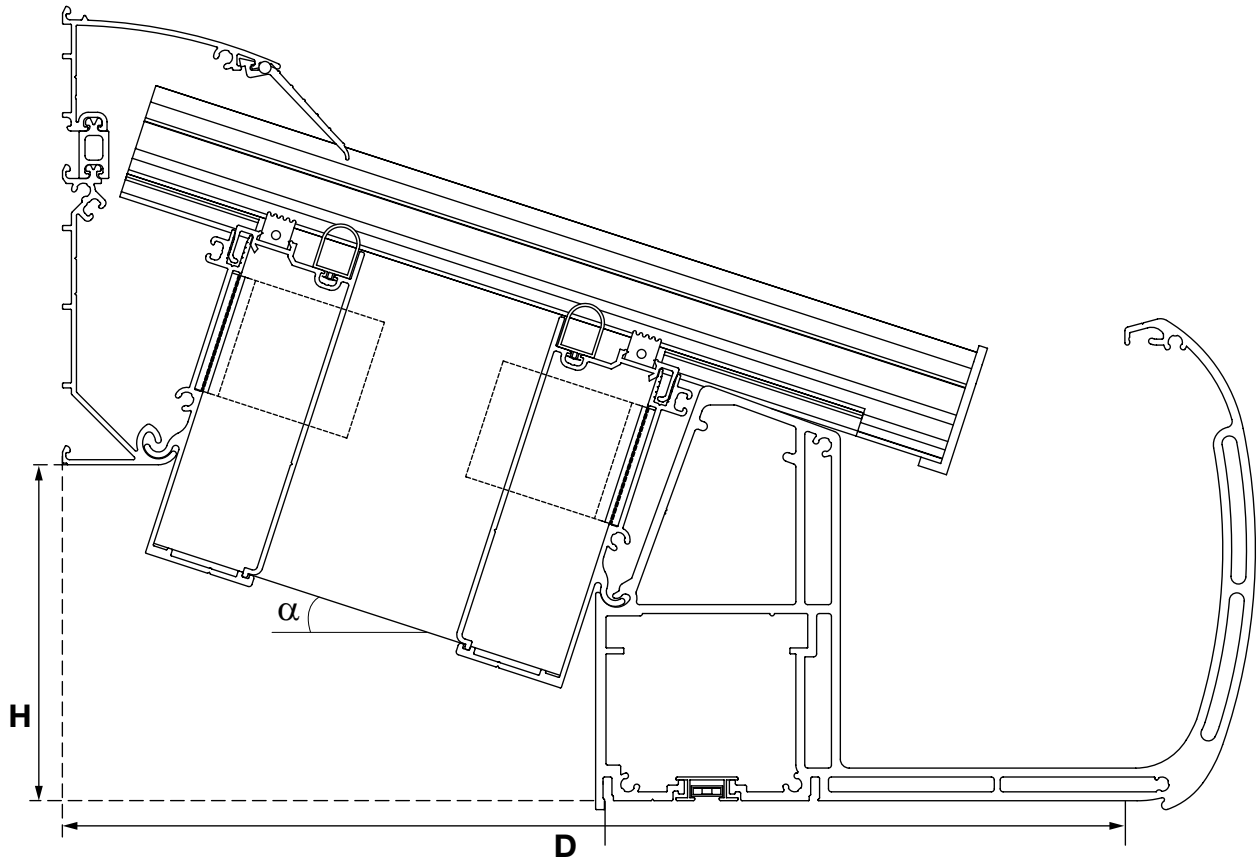

Options

- Width B: ∞
- Depth D: max. 5.5m
- Roof pitch α between 2° and 20° and starting from 5° with multi-walled sheets

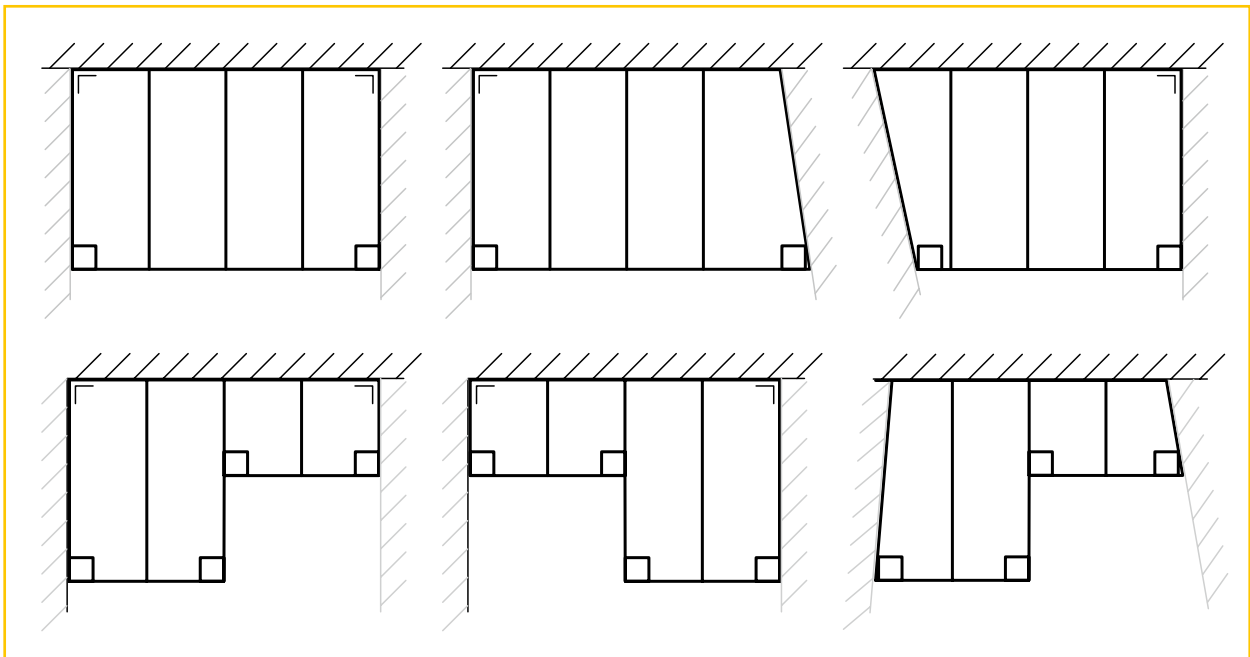

Quick calculator Climax Panorama

Info:

- Aluminium profile system with Panorama gutter and aluminium clips (screwable for glass)
- 2, 3 or 4 posts 110 x 181 x 2500mm are included in the price
- 2 standard RAL colours: white RAL 9010 & anthracite RAL 7016 ST – delivery time: max. 3 weeks
- 9 “trend” RAL colours: cream white RAL 9001, black RAL 9005 ST, white aluminium RAL 9006 ST, grey aluminium RAL 9007 ST, RAL 9009 ST (DB703), RAL 9010 ST, purple red RAL 3004 ST, RAL 7039 ST & RAL 8014 ST – surcharge: € 200 net – delivery time: max. 4 weeks
- Other RAL colours: see p. 8 & 9 (price on request) – delivery time: max. 4 weeks
- Plastic sheets or glass not included in the price
- Maximum deflection of the profiles: 1/200 for sheets and 8mm glass
- Drainpipe and accessories included

Calculate the price as follows:

- Measure the roof’s width B (mm) and depth D (mm).
- Select the next size up in the table and read off the prices of the profiles.
- Multiply the sheet or glass area, indicated in the same box, by the price/m² of the sheet or the glass (not supplied by Skylux).

For 16mm sheets

| CLIMAX PANORAMA prepared for 16mm thick and 980mm wide multi-walled sheets (650N/m ² snow load & pitch 5°) | | | | | | | | |
|---|-------------------|--------|--------|--------|-------------------|---------|---------|---------|
| Width 'B' (in mm) → ↓ Depth 'D' (in mm) | 3000 | 4000 | 5000 | 6000 | 7000 | 8000 | 9000 | 10000 |
| 2500 (2319mm support excl.) | € 3655 | € 4093 | € 4562 | € 5306 | € 5735 | € 7096 | € 7858 | € 8240 |
| #m ² sheets | 7.4 | 9.8 | 12.3 | 14.7 | 17.2 | 19.6 | 22.1 | 24.1 |
| 3000 (2819mm support excl.) | € 3807 | € 4256 | € 4784 | € 5540 | € 6028 | € 7404 | € 8221 | € 8618 |
| #m ² sheets | 8.8 | 11.8 | 14.7 | 17.6 | 20.6 | 23.5 | 26.5 | 29.4 |
| 3500 (3319mm support excl.) | € 3963 | € 4428 | € 5015 | € 5786 | € 6707 | € 7724 | € 8601 | € 9010 |
| #m ² sheets | 10.3 | 13.7 | 17.2 | 20.6 | 24.0 | 27.4 | 30.9 | 34.3 |
| 4000 (3819mm support excl.) | € 4114 | € 4613 | € 5237 | € 6041 | € 7000 | € 8050 | € 8964 | € 9407 |
| #m ² sheets | 11.8 | 15.7 | 19.6 | 23.5 | 27.4 | 31.4 | 35.3 | 39.2 |
| 4500 (4319mm support excl.) | € 4411 | € 4980 | € 5672 | € 6547 | € 7573 | € 8694 | € 9672 | € 10189 |
| #m ² sheets | 13.2 | 17.6 | 22.1 | 26.5 | 30.9 | 35.3 | 39.7 | 44.1 |
| 5000 (4819mm support excl.) | € 5481 | € 6317 | € 7277 | € 8418 | € 9713 | € 11099 | € 12347 | € 13129 |
| #m ² sheets | 14.7 | 19.6 | 24.5 | 29.4 | 34.3 | 39.2 | 44.1 | 49.0 |
| 5500 (5319mm support excl.) | € 5792 | € 6701 | € 7733 | € 9323 | € 10315 | € 11776 | € 13095 | € 13952 |
| #m ² sheets | 17.6 | 23.5 | 29.4 | 35.3 | 41.2 | 47.0 | 52.9 | 58.8 |
| Number of supports* | 2 supports | | | | 3 supports | | | |

Please note: these prices are indicative and not binding!

* For larger spans: see quick calculator with steel reinforcement (p. 34 & 35)

NEW

If necessary, the reinforcement profiles will be delivered with your order.

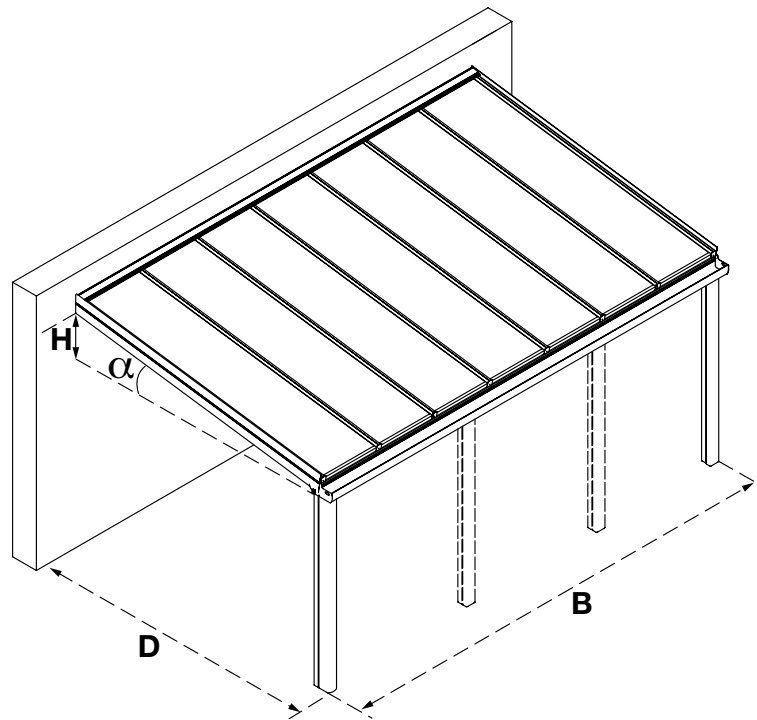

For glass

| CLIMAX PANORAMA prepared for 8mm LSG (850N/m ² snow load & pitch 5°) | | | | | | | | |
|---|------------|--------|------------|---------|---------|---------|------------|---------|
| Width 'B' (in mm) → ↓ Depth 'D' (in mm) | 3000 | 4000 | 5000 | 6000 | 7000 | 8000 | 9000 | 10000 |
| 2500 (2319mm support excl.) | € 4171 | € 4849 | € 5306 | € 6096 | € 6979 | € 8209 | € 9114 | € 9352 |
| #m ² glass panels | 6.9 | 9.2 | 11.5 | 13.9 | 16.2 | 18.5 | 20.8 | 23.2 |
| 3000 (2819mm support excl.) | € 4351 | € 5101 | € 5638 | € 6432 | € 7382 | € 8696 | € 9603 | € 9910 |
| #m ² glass panels | 8.3 | 11.1 | 13.9 | 16.8 | 19.6 | 22.4 | 25.2 | 28.1 |
| 3500 (3319mm support excl.) | € 4529 | € 5363 | € 5970 | € 7146 | € 7794 | € 9188 | € 10098 | € 10487 |
| #m ² glass panels | 9.7 | 13.0 | 16.3 | 19.7 | 23.0 | 24.8 | 29.6 | 32.9 |
| 4000 (3819mm support excl.) | € 4731 | € 5652 | € 6307 | € 7509 | € 8218 | € 9689 | € 10628 | € 11066 |
| #m ² glass panels | 11.2 | 14.9 | 18.8 | 22.6 | 26.4 | 30.2 | 34.0 | 37.8 |
| 4500 (4319mm support excl.) | € 5131 | € 6198 | € 6934 | € 8209 | € 8991 | € 10603 | € 11622 | € 12133 |
| #m ² glass panels | 12.6 | 16.8 | 21.2 | 25.5 | 29.8 | 34.0 | 38.4 | 42.7 |
| 5000 (4819mm support excl.) | € 6483 | € 8090 | € 9095 | € 10640 | € 11693 | € 13845 | € 15133 | € 15914 |
| #m ² glass panels | 14.1 | 18.8 | 23.6 | 28.4 | 33.3 | 37.9 | 42.8 | 47.6 |
| 5500 (5319mm support excl.) | € 7444 | € 9422 | € 10981 | € 12343 | € 13575 | € 16103 | € 17577 | € 19127 |
| #m ² glass panels | 15.5 | 20.7 | 26.0 | 31.3 | 36.7 | 41.8 | 47.1 | 52.4 |
| Number of supports* | 2 supports | | 3 supports | | | | 4 supports | |
| # of glass panels | 4 | 6 | 7 | 8 | 9 | 11 | 12 | 13 |

Please note: these prices are indicative and not binding!

Roof systems with glass and sandwich panels are now also available with a slope of 2°. Prices can be calculated on request with Climafast.

* For larger spans: see quick calculator with steel reinforcement (p. 34 & 35)

NEW If necessary, the reinforcement profiles will be delivered with your order.

Quick calculator Climax Panorama with IPE120 steel reinforcement in the gutter (standard colour & 5° pitch) (IPE120 not included in the price)

Info:

- Aluminium profile system with Panorama gutter and aluminium clips (screwable for glass)
- 2 or 3 posts 110 x 181 x 2500mm are included in the price
- 2 standard RAL colours: white RAL 9010 & anthracite RAL 7016 ST – delivery time: max. 3 weeks
- 9 “trend” RAL colours: cream white RAL 9001, black RAL 9005 ST, white aluminium RAL 9006 ST, grey aluminium RAL 9007 ST, RAL 9009 ST (DB703), RAL 9010 ST, purple red RAL 3004 ST & RAL 7039 ST – surcharge: € 200 net – delivery time: max. 4 weeks
- Other RAL colours: see p. 8 & 9 (price on request) – delivery time: max. 4 weeks
- Plastic sheets or glass not included in the price
- Maximum deflection of the profiles: 1/200 for sheets and 8mm glass
- Drainpipe and accessories included

Calculate the price as follows:

- Measure the roof’s width B (mm) and depth D (mm).
- Select the next size up in the table and read off the prices of the profiles.
- Multiply the sheet or glass area, indicated in the same box, by the price/m² of the sheet or the glass (not supplied by Skylux).

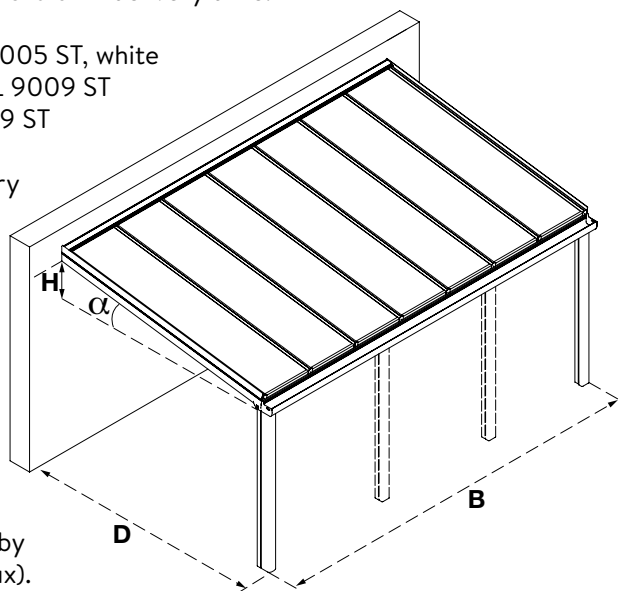

For 16mm sheets

| CLIMAX PANORAMA prepared for 16mm thick and 980mm wide multi-walled sheets (650N/m ² snow load & pitch 5°) | | | | | |
|---|-------------------|-----------------|-------------------|-----------------|-----------------|
| Width 'B' (in mm) → ↓ Depth 'D' (in mm) | 6000 | 7000 | 8000 | 9000 | 10000 |
| 2500 (2319mm support excl.) #m ² sheets | € 5871 14.7 | € 6322 17.2 | € 8272 19.6 | € 9021 22.1 | € 9403 24.1 |
| 3000 (2819mm support excl.) #m ² sheets | € 6105 17.6 | € 6614 20.6 | € 8579 23.5 | € 9384 26.5 | € 9781 29.4 |
| 3500 (3319mm support excl.) #m ² sheets | € 6351 20.6 | € 6919 24.0 | € 8899 27.4 | € 9763 30.9 | € 10172 34.3 |
| 4000 (3819mm support excl.) #m ² sheets | € 6606 23.5 | € 7212 27.4 | € 9226 31.4 | € 10126 35.3 | € 10569 39.2 |
| 4500 (4319mm support excl.) #m ² sheets | € 7112 26.5 | € 7785 30.9 | € 9869 35.3 | € 10835 39.7 | € 11351 44.1 |
| 5000 (4819mm support excl.) #m ² sheets | € 8983 29.4 | € 9925 34.3 | € 12275 39.2 | € 13509 44.1 | € 14291 49.0 |
| 5500 (5319mm support excl.) #m ² sheets | € 9514 35.3 | € 10527 41.2 | € 12952 47.0 | € 14258 52.9 | € 15114 58.8 |
| Number of supports | 2 supports | | 3 supports | | |

Please note: these prices are indicative and not binding!

NEW

If necessary, the reinforcement profiles will be delivered with your order.

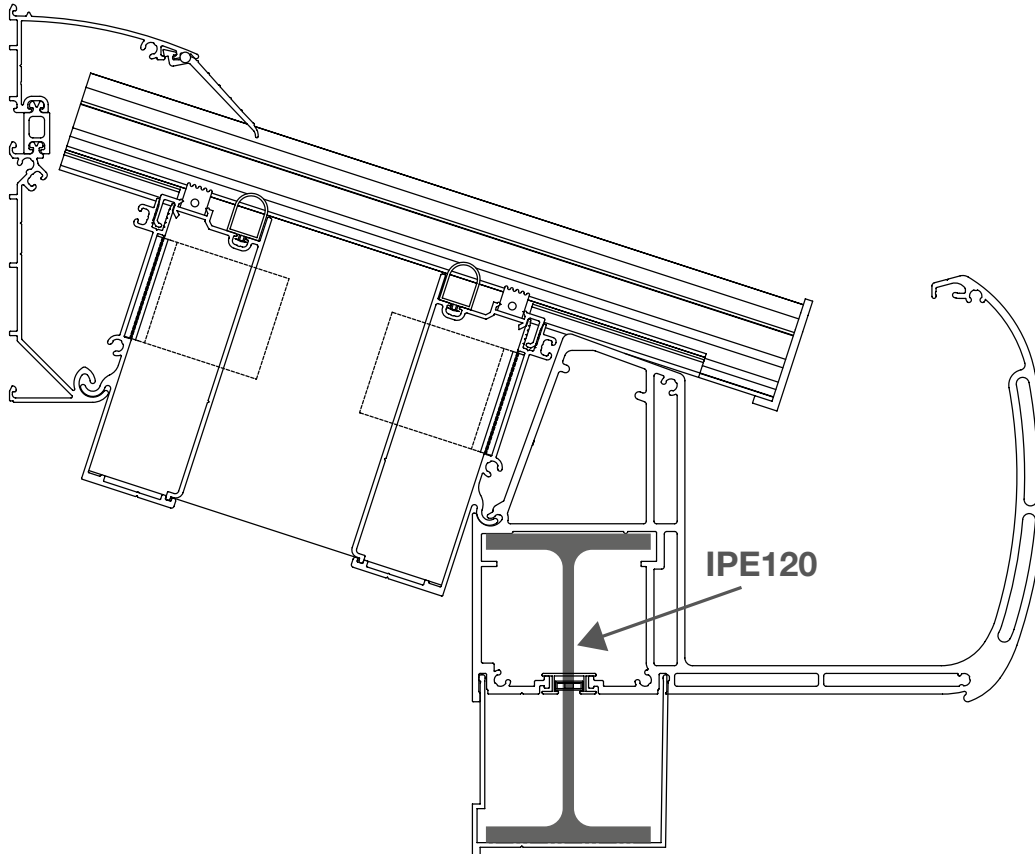

For glass

| CLIMAX PANORAMA prepared for 8mm LSG (850N/m ² snow load & pitch 5°) | | | | | |
|---|-------------------|---------|-------------------|---------|---------|
| Width 'B' (in mm) → ↓ Depth 'D' (in mm) | 6000 | 7000 | 8000 | 9000 | 10000 |
| 2500 (2319mm support excl.) | € 6662 | € 7188 | € 9385 | € 10277 | € 10514 |
| #m ² glass panels | 13.9 | 16.2 | 18.5 | 20.8 | 23.2 |
| 3000 (2819mm support excl.) | € 6997 | € 7591 | € 9872 | € 10765 | € 11073 |
| #m ² glass panels | 16.8 | 19.6 | 22.4 | 25.2 | 28.1 |
| 3500 (3319mm support excl.) | € 7334 | € 8004 | € 10363 | € 11261 | € 11650 |
| #m ² glass panels | 19.7 | 23.0 | 24.8 | 29.6 | 32.9 |
| 4000 (3819mm support excl.) | € 7697 | € 8837 | € 10864 | € 11790 | € 12228 |
| #m ² glass panels | 22.6 | 26.4 | 30.2 | 34.0 | 37.8 |
| 4500 (4319mm support excl.) | € 8397 | € 9610 | € 11779 | € 12784 | € 13295 |
| #m ² glass panels | 25.5 | 29.8 | 34.0 | 38.4 | 42.7 |
| 5000 (4819mm support excl.) | € 10828 | € 12311 | € 15020 | € 16296 | € 17077 |
| #m ² glass panels | 28.4 | 33.3 | 37.9 | 42.8 | 47.6 |
| 5500 (5319mm support excl.) | € 12531 | € 14193 | € 15986 | € 18740 | € 19706 |
| #m ² glass panels | 31.3 | 36.7 | 41.8 | 47.1 | 52.4 |
| Number of supports | 2 supports | | 3 supports | | |
| # of glass panels | 8 | 9 | 11 | 12 | 13 |

Please note: these prices are indicative and not binding!

Roof systems with glass are now also available with a slope of 2°. Prices can be calculated on request with Climafast.

NEW If necessary, the reinforcement profiles will be delivered with your order.

Quick calculator Climax Panorama freestanding roof

A Climax Panorama roof system can also be installed as a freestanding patio roof instead of against a wall. A freestanding patio roof does not need any supporting walls and can be placed anywhere in your garden. As with all Climalux systems, the detached version combines with plastic sheets (16 or 32mm) or glass. To guarantee the stability of a freestanding patio roof, the posts must be concreted into the ground according to our instructions.

For 16mm sheets – freestanding

| CLIMAX PANORAMA FREESTANDING prepared for 16mm thick and 980mm wide multi-walled sheets (650N/m ² snow load & 5° pitch) | | | | | |
|---|------------------------|---------------|---------------|---------------|------------------------|
| Width 'B' (in mm) → ↓ Depth 'D' (in mm) | 3000 | 4000 | 5000 | 6000 | 7000 |
| 2500 (2209mm support excl.) | € 5335 | € 6005 | € 6472 | € 7378 | € 7963 |
| #m ² sheets | 6.8 | 9.3 | 11.7 | 13.7 | 16.1 |
| 3000 (2709mm support excl.) | € 5579 | € 6271 | € 6796 | € 7715 | € 8366 |
| #m ² sheets | 8.8 | 11.7 | 14.7 | 17.6 | 20.5 |
| 3500 (3209mm support excl.) | € 5738 | € 6442 | € 7027 | € 7961 | € 9156 |
| #m ² sheets | 10.2 | 13.7 | 17.1 | 20.5 | 23.5 |
| 4000 (3709mm support excl.) | € 6346 | € 7087 | € 7709 | € 8676 | € 9909 |
| #m ² sheets | 11.7 | 15.6 | 19.6 | 23.5 | 27.4 |
| front posts VS back posts | 2 & 2 posts | | | | 3 & 2 posts |
| 4500 (4209mm support excl.) | € 6646 | € 7455 | € 8144 | € 9182 | € 10844 |
| #m ² sheets | 13.2 | 17.6 | 22.0 | 26.4 | 30.8 |
| 5000 (4709mm support excl.) | € 6649 | € 7461 | € 8152 | € 9190 | € 10856 |
| #m ² sheets | 14.7 | 19.6 | 24.5 | 29.4 | 34.3 |
| front posts VS back posts | 2 & 2 posts | | | | 3 & 3 posts |

Please note: these prices are indicative and not binding!

The front posts below the gutter are 150 x 181mm. The back posts below the GDX are 110 x 110mm. All posts must be concreted into the ground at least 40cm deep.

NEW

If necessary, the reinforcement profiles will be delivered with your order.

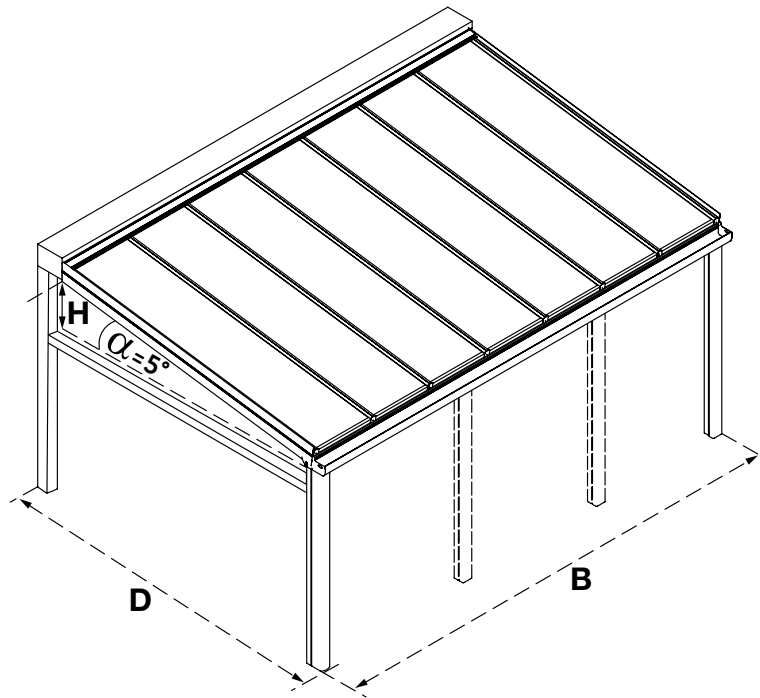

For glass – freestanding

| CLIMAX PANORAMA FREESTANDING prepared for 8mm LSG (850N/m ² snow load & 5° pitch) | | | | | |
|---|----------------|-----------------|-----------------|-----------------|-----------------|
| Width 'B' (in mm) → ↓ Depth 'D' (in mm) | 3000 | 4000 | 5000 | 6000 | 7000 |
| 2500 (2209mm support excl.) #m ² glass panels | € 5811 6.5 | € 6752 8.7 | € 7202 10.9 | € 8122 13.2 | € 9319 15.4 |
| front posts VS back posts* | 2 & 2 posts | | | | 3 & 2 posts |
| 3000 (2709mm support excl.) #m ² glass panels | € 6119 7.9 | € 7112 10.6 | € 7645 13.3 | € 8604 16.1 | € 10065 18.8 |
| 3500 (3209mm support excl.) #m ² glass panels | € 6297 9.4 | € 7370 12.5 | € 7977 15.7 | € 9427 19.0 | € 10477 22.1 |
| front posts VS back posts* | 2 & 2 posts | | | 3 & 2 posts | 3 & 3 posts |
| 4000 (3709mm support excl.) #m ² glass panels | € 6959 10.8 | € 8118 14.4 | € 8774 18.1 | € 10612 21.8 | € 11483 25.5 |
| 4500 (4209mm support excl.) #m ² glass panels | € 7359 12.2 | € 8665 16.3 | € 9400 20.5 | € 11312 24.7 | € 12257 28.9 |
| 5000 (4709mm support excl.) #m ² glass panels | € 8710 13.7 | € 10556 18.3 | € 11562 22.9 | € 13743 27.6 | € 14958 32.3 |
| front posts VS back posts | 2 & 2 posts | | | 3 & 3 posts | |
| # of glass panels | 4 | 6 | 7 | 8 | 9 |

Please note: these prices are indicative and not binding!

The front posts below the gutter are 150 x 181mm. The back posts below the GDX are 110 x 110mm. All posts must be concreted into the ground at least 40cm deep.

Roof systems with glass are now also available with a slope of 2°. Prices can be calculated on request with Climafast.

NEW If necessary, the reinforcement profiles will be delivered with your order.

SELF-SUPPORTING THERMAL PROFILE SYSTEM (warm roof)

CLIMAX

The self-supporting Climax system offers numerous possibilities: a roof between two walls, various shapes, gutter and post types, with and without integrated water drainage, finish with rubber strips, clips, various side finishes, oblique closure with side walls, etc. There is always a solution that's right for you.

Provided the raised GD2 gutter support is used, the Climax roof is self-supporting up to 7m in width between two posts (with 16mm plastic sheets and a depth of 3m). is self-supporting up to 5.5m in depth. The roof pitch is variable between 5° and 45°.

Both 16 and 32mm thick (insulating) plastic sheets or max. 34mm thick glass can be used as glazing for your thermal Climax roof.

- 2 standard RAL colours: white RAL 9010 & anthracite RAL 7016 ST. Delivery time: max. 3 weeks.
- 9 "trend" RAL colours: cream white RAL 9001, black RAL 9005 ST, white aluminium RAL 9006 ST, grey aluminium RAL 9007 ST, RAL 9009 ST (DB703), RAL 9010 ST, purple red RAL 3004 ST, RAL 7039 ST & RAL 8014 ST. Surcharge: € 200 net. Delivery time: max. 4 weeks.
- Other RAL colours: see p. 8 & 9 (price on request). Delivery time: max. 4 weeks.

Climax can also be provided with Climaled (see p. 84).



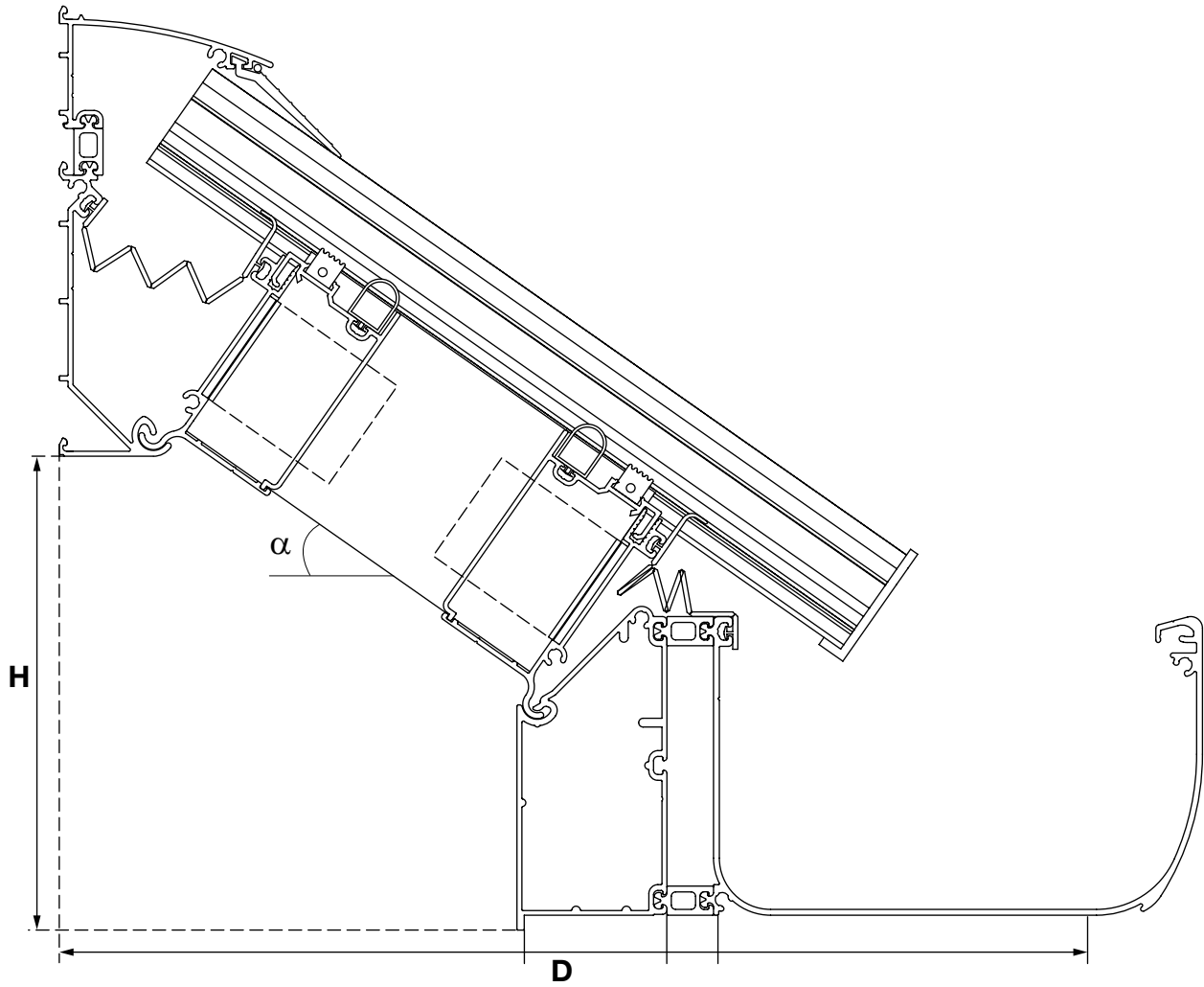

Options

- Width B: ∞
- Depth D: max. 6197mm with steel reinforcement
- Pitch α : 5° to 45°

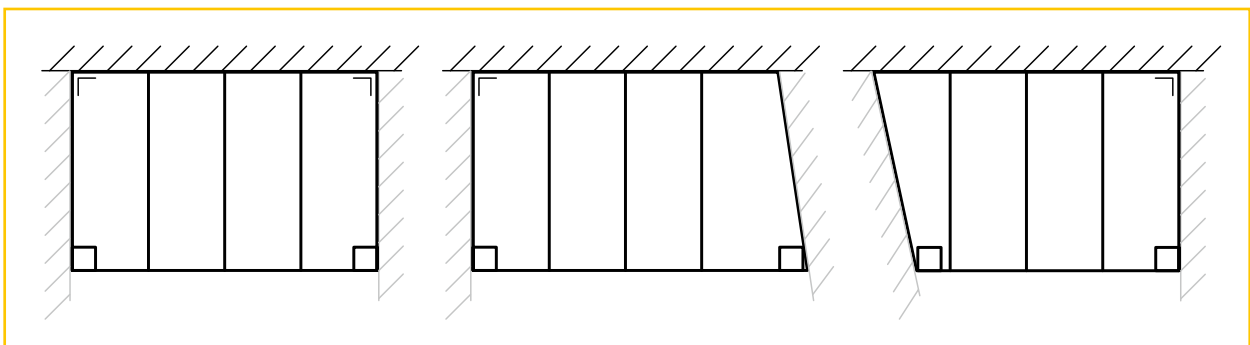

Price list profiles and accessories for Climax, Climalux, Climacrown, Triangle, Windbreak and Climaglide

1. Profiles

| GROUP | TYPE | DESCRIPTION | LENGTH | ARTICLE NUMBER | | | | UN. | PRICE / UNIT | | |
|----------|----------------------------|--------------------------|--------|----------------|--------|---------|---------|---------|--------------|------------------|---------|
| | | | | 0 | 9010 | 7016 ST | RAL | | 0 | STANDARD COLOURS | RAL * |
| M | WALL PROFILES | MX Wall profile Climalux | 3.04 | 110501 | 110502 | 110503 | 110504 | m | € 38.24 | € 43.98 | € 50.58 |
| | | | 3.54 | 34807 | 34822 | 34826 | 34830 | m | € 38.24 | € 43.98 | € 50.58 |
| | | | 4.04 | 36522 | 36525 | 36528 | 36593 | m | € 38.24 | € 43.98 | € 50.58 |
| | | | 4.54 | 110505 | 110506 | 110507 | 110508 | m | € 38.24 | € 43.98 | € 50.58 |
| | | | 5.04 | 34819 | 34823 | 34827 | 34831 | m | € 38.24 | € 43.98 | € 50.58 |
| | | | 6.04 | 34820 | 34824 | 34828 | 34832 | m | € 38.24 | € 43.98 | € 50.58 |
| | | | 7.04 | 34821 | 34825 | 34829 | 34833 | m | € 38.24 | € 43.98 | € 50.58 |
| | MX32 Wall profile Climalux | 3.04 | 110509 | 110510 | 110511 | 110512 | m | € 41.30 | € 47.48 | € 54.60 | |
| | | 3.54 | 60372 | 60375 | 60374 | 60373 | m | € 41.30 | € 47.48 | € 54.60 | |
| | | 4.04 | 60376 | 60379 | 60378 | 60377 | m | € 41.30 | € 47.48 | € 54.60 | |
| | | 4.54 | 110513 | 110514 | 110515 | 110516 | m | € 41.30 | € 47.48 | € 54.60 | |
| | | 5.04 | 60380 | 60383 | 60382 | 60381 | m | € 41.30 | € 47.48 | € 54.60 | |
| | | 6.04 | 60384 | 60387 | 60386 | 60385 | m | € 41.30 | € 47.48 | € 54.60 | |
| | | 7.04 | 60388 | 60391 | 60390 | 60389 | m | € 41.30 | € 47.48 | € 54.60 | |
| | MT Wall profile top | 3.54 | 21342 | 21348 | 31205 | 21351 | m | € 16.60 | € 19.68 | € 22.63 | |
| | | 4.29 | 23376 | 23379 | 31206 | 23378 | m | € 16.60 | € 19.68 | € 22.63 | |
| | | 5.04 | 21343 | 21349 | 31207 | 21352 | m | € 16.60 | € 19.68 | € 22.63 | |
| | | 7.04 | 21344 | 21350 | 31208 | 21353 | m | € 16.60 | € 19.68 | € 22.63 | |
| | | MB Wall profile bottom | 3.54 | 21354 | 21360 | 31109 | 21363 | m | € 24.04 | € 27.62 | € 31.76 |
| | 4.29 | | 23380 | 23383 | 31110 | 23382 | m | € 24.04 | € 27.62 | € 31.76 | |
| | 5.04 | | 21355 | 21361 | 31111 | 21364 | m | € 24.04 | € 27.62 | € 31.76 | |
| | 7.04 | | 21356 | 21362 | 31112 | 21365 | m | € 24.04 | € 27.62 | € 31.76 | |
| | S1 Hinge profile S1 | 3.54 | 21366 | 21372 | 31117 | 21375 | m | € 16.83 | € 19.35 | € 22.25 | |
| | | 4.29 | 23384 | 23387 | 31118 | 23386 | m | € 16.83 | € 19.35 | € 22.25 | |
| | | 5.04 | 21367 | 21373 | 31119 | 21376 | m | € 16.83 | € 19.35 | € 22.25 | |
| | | 7.04 | 21368 | 21374 | 31120 | 21377 | m | € 16.83 | € 19.35 | € 22.25 | |
| | S2 Hinge profile S2 | 3.54 | 23479 | 23488 | 31121 | 23485 | m | € 22.99 | € 26.43 | € 30.39 | |
| | | 5.04 | 23480 | 23489 | 31122 | 23486 | m | € 22.99 | € 26.43 | € 30.39 | |
| 7.04 | | 23481 | 23490 | 31123 | 23487 | m | € 22.99 | € 26.43 | € 30.39 | | |

| GROUP | TYPE | DESCRIPTION | LENGTH | ARTICLE NUMBER | | | | UN. | PRICE / UNIT | | |
|----------|--|--------------------|--------|----------------|--------|---------|--------|---------|--------------|------------------|----------|
| | | | | 0 | 9010 | 7016 ST | RAL | | 0 | STANDARD COLOURS | RAL * |
| G | GUTTERS | GX Gutter Climalux | 3.04 | 110485 | 110486 | 110487 | 110488 | m | € 106.10 | € 122.01 | € 140.31 |
| | | | 3.54 | 34834 | 34838 | 34842 | 34846 | m | € 106.10 | € 122.01 | € 140.31 |
| | | | 4.04 | 36513 | 36516 | 36519 | 36590 | m | € 106.10 | € 122.01 | € 140.31 |
| | | | 4.54 | 110489 | 110490 | 110491 | 110492 | m | € 106.10 | € 122.01 | € 140.31 |
| | | | 5.04 | 34835 | 34839 | 34843 | 34847 | m | € 106.10 | € 122.01 | € 140.31 |
| | | | 6.04 | 34836 | 34840 | 34844 | 34848 | m | € 106.10 | € 122.01 | € 140.31 |
| | | | 7.04 | 34837 | 34841 | 34845 | 34849 | m | € 106.10 | € 122.01 | € 140.31 |
| | GLX Ornamental profile Climalux for gutter | 3.54 | 34850 | 34853 | 34856 | 34859 | m | € 65.39 | € 75.19 | € 86.47 | |
| | | 5.04 | 34851 | 34854 | 34857 | 34860 | m | € 65.39 | € 75.19 | € 86.47 | |
| | | 6.04 | 36550 | 36551 | 36552 | 36553 | m | € 65.39 | € 75.19 | € 86.47 | |
| | | 7.04 | 34852 | 34855 | 34858 | 34861 | m | € 65.39 | € 75.19 | € 86.47 | |









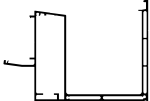

FINISHING

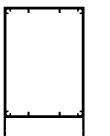
0: mill-finished aluminium or standard

RAL 9010 white / RAL 7016 ST anthracite structure: in stock (delivery time max. 3 weeks)

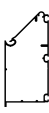
Other standard RAL colours: start up costs of € 200 net for each colour (delivery time max. 4 weeks)

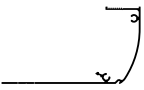
* any other RAL colour: +15% and start up cost of € 200 net for each colour (delivery time max. 4 weeks)

| GROUP | TYPE | DESCRIPTION | LENGTH | ARTICLE NUMBER | | | UN. | PRICE / UNIT | | | |
|---|---|--|---|----------------|--------|---------|----------|--------------|----------|------------------|----------|
| | | | | 0 | 9010 | 7016 ST | | RAL | 0 | STANDARD COLOURS | RAL * |
| G | GIX | Connecting piece Climalux for GX | 0.3 | 35703 | | | pc | € 59.00 | | | |
| | | |  | | | | | | | | |
| | GXLX | Gutter XL Climalux Horizon | 4.04 | 110493 | 110494 | 110495 | 110496 | m | € 153.74 | € 179.85 | € 206.83 |
| | | | 4.54 | 110497 | 110498 | 110499 | 110500 | m | € 153.74 | € 179.85 | € 206.83 |
| | | | 5.04 | 71505 | 71508 | 71507 | 71506 | m | € 153.74 | € 179.85 | € 206.83 |
| | | | 6.04 | 71509 | 71512 | 71511 | 71510 | m | € 153.74 | € 179.85 | € 206.83 |
| | | | 7.04 | 71513 | 71516 | 71515 | 71514 | m | € 153.74 | € 179.85 | € 206.83 |
| |  | | | | | | | | | | |
| | GIXL | Connecting piece Climalux for GXLX | 0.3 | 71991 | | | pc | € 23.44 | | | |
| | | |  | | | | | | | | |
| | GDX | Cross-beam Climalux for overhang | 3.54 | 51834 | 51836 | 51835 | 51862 | m | € 121.20 | € 135.30 | € 155.60 |
| | | | 5.04 | 51837 | 51839 | 51838 | 51863 | m | € 121.20 | € 135.30 | € 155.60 |
| | | | 6.04 | 51840 | 51842 | 51841 | 51864 | m | € 121.20 | € 135.30 | € 155.60 |
| | | | 7.04 | 51843 | 51845 | 51844 | 51865 | m | € 121.20 | € 135.30 | € 155.60 |
| |  | | | | | | | | | | |
| | GDCX | Clip profile Climalux for cross-beam GDX | 3.54 | 51846 | 51849 | 51848 | 51847 | m | € 22.55 | € 24.87 | € 28.60 |
| | | | 5.04 | 51850 | 51853 | 51852 | 51851 | m | € 22.55 | € 24.87 | € 28.60 |
| | | | 6.04 | 51854 | 51857 | 51856 | 51855 | m | € 22.55 | € 24.87 | € 28.60 |
| | | | 7.04 | 51858 | 51861 | 51860 | 51859 | m | € 22.55 | € 24.87 | € 28.60 |
| |  | | | | | | | | | | |
| G | Gutter Climax | 3.54 | 21385 | 21391 | 31214 | 21394 | m | € 49.78 | € 57.25 | € 65.84 | |
| | | 4.29 | 23388 | 23391 | 31215 | 23390 | m | € 49.78 | € 57.25 | € 65.84 | |
| | | 5.04 | 21386 | 21392 | 31216 | 21395 | m | € 49.78 | € 57.25 | € 65.84 | |
| | | 7.04 | 21387 | 21393 | 31217 | 21396 | m | € 49.78 | € 57.25 | € 65.84 | |
|  | | | | | | | | | | | |
| GI | Internal gutter for G | 7 | 27286 | | | m | € 36.01 | | | | |
| GI 0 | Connecting piece for G | 0.3 | 27732 | | | pc | € 27.81 | | | | |
| GI 90 | Outside corner piece 90° | | 27559 | | | pc | € 81.49 | | | | |
| GI 120 | Outside corner piece 120° | | 27560 | | | pc | € 81.49 | | | | |
| GI 135 | Outside corner piece 135° | | 27561 | | | pc | € 81.49 | | | | |
| GI 150 | Outside corner piece 150° | | 27562 | | | pc | € 81.49 | | | | |
| GI -90 | Inside corner piece 90° | | 27563 | | | pc | € 81.49 | | | | |
| GIP | Connecting piece for GDG | 0.5 | 35884 | | | pc | € 131.03 | | | | |
|  | | | | | | | | | | | |
| GD1 | Gutter support GD1 | 3.54 | 21397 | 21403 | 31218 | 21406 | m | € 33.10 | € 38.08 | € 43.79 | |
| | | 4.29 | 23392 | 23395 | 31219 | 23394 | m | € 33.10 | € 38.08 | € 43.79 | |
| | | 5.04 | 21398 | 21404 | 31220 | 21407 | m | € 33.10 | € 38.08 | € 43.79 | |
| | | 7.04 | 21399 | 21405 | 31221 | 21408 | m | € 33.10 | € 38.08 | € 43.79 | |
|  | | | | | | | | | | | |
| GD2 | Gutter support GD2 | 5.04 | 27271 | 27280 | 31126 | 27284 | m | € 91.85 | € 96.33 | € 110.78 | |
| | | 7.04 | 27272 | 27281 | 31127 | 27285 | m | € 91.85 | € 96.33 | € 110.78 | |
|  | | | | | | | | | | | |
| PL165 | Steel plate 160 x 5 galvanised | 6.15 | 36335 | | | m | € 50.77 | | | | |
| GD2C | Cover for gutter support GD2 | 5.04 | 27309 | 27317 | 31136 | 27321 | m | € 26.86 | € 35.08 | € 40.34 | |
| | | 7.04 | 27310 | 27318 | 31137 | 27322 | m | € 26.86 | € 35.08 | € 40.34 | |
|  | | | | | | | | | | | |
| GDP | Thermal profile for GD2 | 6 | 27338 | | | m | € 12.36 | | | | |
|  | | | | | | | | | | | |

FINISHING







0: mill-finished aluminium or standard

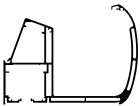
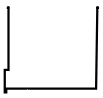

RAL 9010 white / RAL 7016 ST anthracite structure: in stock (delivery time max. 3 weeks)

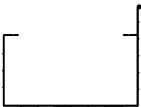
Other standard RAL colours: start up costs of € 200 net for each colour (delivery time max. 4 weeks)

* any other RAL colour: +15% and start up cost of € 200 net for each colour (delivery time max. 4 weeks)

ACCESSORIES FOR SELF-SUPPORTING SYSTEMS

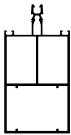
| GROUP | TYPE | DESCRIPTION | LENGTH | ARTICLE NUMBER | | | | UN. | PRICE / UNIT | | |
|---|---------|--|--------|----------------|-------|---------|-------|-----|--------------|------------------|----------|
| G | GUTTERS | | M | 0 | 9010 | 7016 ST | RAL | | 0 | STANDARD COLOURS | RAL * |
|  | GDG | Self-supporting gutter Climax | 4.04 | 31607 | 31615 | 31609 | 31613 | m | € 176.69 | € 202.40 | € 232.76 |
| | | | 5.04 | 29908 | 29912 | 31128 | 29914 | m | € 176.69 | € 202.40 | € 232.76 |
| | | | 6.04 | 31608 | 31616 | 31610 | 31614 | m | € 176.69 | € 202.40 | € 232.76 |
| | | | 7.04 | 29909 | 29913 | 31129 | 29915 | m | € 176.69 | € 202.40 | € 232.76 |
| | GDGK | Cover for IPE in GDG | 7.04 | 29922 | 29928 | 31131 | 29926 | m | € 21.20 | € 27.62 | € 31.76 |
|  | GDGL | LED profile for GDG | 4.04 | 31627 | 31631 | 31633 | 31635 | m | € 2.36 | € 6.59 | € 7.58 |
| | | | 5.04 | 29930 | 29936 | 31132 | 29934 | m | € 2.36 | € 6.59 | € 7.58 |
| | | | 6.04 | 31628 | 31632 | 31634 | 31636 | m | € 2.36 | € 6.59 | € 7.58 |
| | | | 7.04 | 29931 | 29937 | 31133 | 29935 | m | € 2.36 | € 6.59 | € 7.58 |
|  | SB | Hinge bottom | 3.54 | 21416 | 21422 | 31138 | 21425 | m | € 11.61 | € 13.35 | € 15.35 |
| | | | 5.04 | 21417 | 21423 | 31139 | 21426 | m | € 11.61 | € 13.35 | € 15.35 |
| | | | 7.04 | 21418 | 21424 | 31140 | 21427 | m | € 11.61 | € 13.35 | € 15.35 |
|  | G120A | Gutter 120A | 3.5 | 13283 | 13294 | 54976 | 21160 | m | € 27.48 | € 34.21 | € 39.34 |
| | | | 5 | 13285 | 13295 | 54977 | 21161 | m | € 27.48 | € 34.21 | € 39.34 |
| | | | 7 | 13291 | 13296 | 54978 | 21162 | m | € 27.48 | € 34.21 | € 39.34 |
|  | GR | Raised profile for gutter | 3.54 | 17820 | 17828 | 31343 | 21163 | m | € 21.22 | € 24.42 | € 28.08 |
| | | | 5.04 | 17819 | 17830 | 31344 | 21164 | m | € 21.22 | € 24.42 | € 28.08 |
| | | | 7.04 | 17821 | 17831 | 31345 | 21165 | m | € 21.22 | € 24.42 | € 28.08 |
|  | VS | Steel tube 80 x 25 x 3 galva for GX | 6 | 51818 | | | | m | € 45.09 | | |
| | | | | | | | | | | | |
|  | V1243 | Steel tube 120 x 40 x 3 galva for GXLX | 6 | 72217 | | | | m | € 53.47 | | |
| | | | 7 | 110027 | | | | m | € 71.64 | | |
|  | IPE120 | Profile IPE120 for GDG | 7 | 109888 | | | | m | € 60.64 | | |
| | | | | | | | | | | | |

| GROUP | TYPE | DESCRIPTION | LENGTH | ARTICLE NUMBER | | | | UN. | PRICE / UNIT | | |
|---|---------|------------------------|--------|----------------|--------|---------|--------|-----|--------------|------------------|---------|
| T | RAFTERS | | M | 0 | 9010 | 7016 ST | RAL | | 0 | STANDARD COLOURS | RAL * |
|  | DX | Rafter Climalux | 2.5 | 34862 | 34867 | 34872 | 34877 | m | € 47.83 | € 56.26 | € 64.70 |
| | | | 3 | 34863 | 34868 | 34873 | 34878 | m | € 47.83 | € 56.26 | € 64.70 |
| | | | 3.25 | 110162 | 110166 | 110168 | 110164 | m | € 47.83 | € 56.26 | € 64.70 |
| | | | 3.5 | 34864 | 34869 | 34874 | 34879 | m | € 47.83 | € 56.26 | € 64.70 |
| | | | 3.75 | 110480 | 110481 | 110482 | 110483 | m | € 47.83 | € 56.26 | € 64.70 |
| | | | 4 | 34865 | 34870 | 34875 | 34880 | m | € 47.83 | € 56.26 | € 64.70 |
|  | DX2 | Rafter Climalux type 2 | 4.5 | 109358 | 109360 | 109361 | 109359 | m | € 47.83 | € 56.26 | € 64.70 |
| | | | 4 | 108984 | 108988 | 108990 | 108986 | m | € 63.27 | € 74.42 | € 85.57 |
| | | | 4.5 | 108532 | 108541 | 108538 | 108535 | m | € 63.27 | € 74.42 | € 85.57 |
| | | | 5 | 108985 | 108989 | 108991 | 108987 | m | € 63.27 | € 74.42 | € 85.57 |
| | | | 5.5 | 108533 | 108542 | 108539 | 108536 | m | € 63.27 | € 74.42 | € 85.57 |
| | | | 6 | 108534 | 108543 | 108540 | 108537 | m | € 63.27 | € 74.42 | € 85.57 |







FINISHING

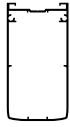

0: mill-finished aluminium or standard

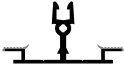
RAL 9010 white / RAL 7016 ST anthracite structure: in stock (delivery time max. 3 weeks)

Other standard RAL colours: start up costs of € 200 net for each colour (delivery time max. 4 weeks)

* any other RAL colour: +15% and start up cost of € 200 net for each colour (delivery time max. 4 weeks)

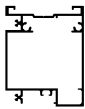
| GROUP | TYPE | DESCRIPTION | LENGTH | ARTICLE NUMBER | | | UN. | PRICE / UNIT | | | |
|---|---------|---|--------|----------------|-------|---------|-------|--------------|------------------|---------|----------|
| T | RAFTERS | | M | 0 | 9010 | 7016 ST | RAL | 0 | STANDARD COLOURS | RAL * | |
|  | D1 | Rafter 1 | 2.54 | 21246 | 21261 | 31145 | 21256 | m | € 26.08 | € 29.98 | € 34.48 |
| | | | 3.04 | 21247 | 21262 | 31146 | 21257 | m | € 26.08 | € 29.98 | € 34.48 |
| | | | 3.54 | 21248 | 21263 | 31147 | 21258 | m | € 26.08 | € 29.98 | € 34.48 |
| | | | 4.04 | 21249 | 21264 | 31148 | 21259 | m | € 26.08 | € 29.98 | € 34.48 |
| | | | 6.04 | 21250 | 21265 | 31149 | 21260 | m | € 26.08 | € 29.98 | € 34.48 |
|  | D2 | Rafter 2 | 3.54 | 23467 | 23476 | 31150 | 23473 | m | € 37.97 | € 43.65 | € 50.20 |
| | | | 4.04 | 23468 | 23477 | 31151 | 23474 | m | € 37.97 | € 43.65 | € 50.20 |
| | | | 5.04 | 24446 | 24448 | 31152 | 24449 | m | € 37.97 | € 43.65 | € 50.20 |
| | | | 6.04 | 23469 | 23478 | 31153 | 23475 | m | € 37.97 | € 43.65 | € 50.20 |
|  | D3 | Rafter 3 | 5.04 | 41742 | 41674 | 41676 | 41678 | m | € 90.76 | € 95.29 | € 109.58 |
| | | | 5.5 | 43312 | 43315 | 43314 | 43313 | m | € 90.76 | € 95.29 | € 109.58 |
|  | TP | Thermal rafter of PVC | 2.7 | 21277 | | | | m | € 10.48 | | |
| | | | 3.2 | 21278 | | | | m | € 10.48 | | |
| | | | 3.7 | 21279 | | | | m | € 10.48 | | |
| | | | 4.2 | 21280 | | | | m | € 10.48 | | |
| | | | 5.2 | 24468 | | | | m | € 10.48 | | |
| | | | 6.2 | 21281 | | | | m | € 10.48 | | |
|  | TPG | Thermal rafter of PVC for glass | 4.2 | 25055 | | | | m | € 10.48 | | |
| | | | 5.2 | 25056 | | | | m | € 10.48 | | |
| | | | 6.2 | 25057 | | | | m | € 10.48 | | |
| | | | 7.2 | 25058 | | | | m | € 10.48 | | |
|  | V642 | Steel tube 60 x 40 x 2 galva for D1 and GD1 | 4 | 21514 | | | | m | € 16.09 | | |
| | | | 5 | 28964 | | | | m | € 16.09 | | |
| | | | 6 | 21515 | | | | m | € 16.09 | | |
|  | V853 | Steel tube 80 x 50 x 3 galva for DX2 | 6 | 108544 | | | | m | € 60.21 | | |
|  | V1044 | Steel tube 100 x 40 x 4 galva for D2 | 6 | 43690 | | | | m | € 62.95 | | |

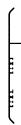
| GROUP | TYPE | DESCRIPTION | LENGTH | ARTICLE NUMBER | | | UN. | PRICE / UNIT | | | |
|---|--------------|-------------------------|--------|----------------|-------|---------|-------|--------------|------------------|---------|---------|
| L | SIDE RAFTERS | | M | 0 | 9010 | 7016 ST | RAL | 0 | STANDARD COLOURS | RAL * | |
|  | ZD | Side rafter | 2.54 | 21282 | 21298 | 31154 | 21293 | m | € 27.20 | € 31.78 | € 36.55 |
| | | | 3.04 | 21284 | 21299 | 31155 | 21294 | m | € 27.20 | € 31.78 | € 36.55 |
| | | | 3.54 | 21285 | 21300 | 31156 | 21295 | m | € 27.20 | € 31.78 | € 36.55 |
| | | | 4.04 | 21286 | 21301 | 31157 | 21296 | m | € 27.20 | € 31.78 | € 36.55 |
| | | | 6.04 | 21287 | 21302 | 31158 | 21297 | m | € 27.20 | € 31.78 | € 36.55 |
| | | | 6.04 | 24018 | 24020 | 31169 | 24021 | m | € 17.05 | € 19.62 | € 22.56 |
|  | ZD2B | Side rafter D2 clip | 6.04 | 24018 | 24020 | 31169 | 24021 | m | € 17.05 | € 19.62 | € 22.56 |
|  | ZDC | Side cover 16, 25, 32mm | 2.84 | 21304 | 21332 | 31164 | 21337 | m | € 36.80 | € 42.33 | € 48.68 |
| | | | 3.34 | 21305 | 21333 | 31165 | 21338 | m | € 36.80 | € 42.33 | € 48.68 |
| | | | 3.84 | 21306 | 21334 | 31166 | 21339 | m | € 36.80 | € 42.33 | € 48.68 |
| | | | 4.34 | 21307 | 21335 | 31167 | 21340 | m | € 36.80 | € 42.33 | € 48.68 |
| | | | 6.34 | 21308 | 21336 | 31168 | 21341 | m | € 36.80 | € 42.33 | € 48.68 |

FINISHING

0: mill-finished aluminium or standard





RAL 9010 white / RAL 7016 ST anthracite structure: in stock (delivery time max. 3 weeks)

Other standard RAL colours: start up costs of € 200 net for each colour (delivery time max. 4 weeks)

* any other RAL colour: +15% and start up cost of € 200 net for each colour (delivery time max. 4 weeks)

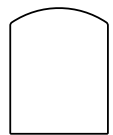
ACCESSORIES FOR SELF-SUPPORTING SYSTEMS

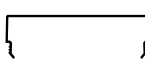
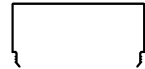
| GROUP | TYPE | DESCRIPTION | LENGTH | ARTICLE NUMBER | | | | UN. | PRICE / UNIT | | |
|---|--------------|---------------------------|--------|----------------|-------|---------|-------|-----|--------------|------------------|---------|
| L | SIDE RAFTERS | | M | 0 | 9010 | 7016 ST | RAL | | 0 | STANDARD COLOURS | RAL * |
|  | L16P | Side profile 16, 25, 32mm | 2.54 | 16718 | 15478 | 31347 | 21231 | m | € 11.87 | € 13.64 | € 15.69 |
| | | | 3.04 | 16719 | 15479 | 31348 | 21232 | m | € 11.87 | € 13.64 | € 15.69 |
| | | | 3.54 | 16720 | 15480 | 31349 | 21233 | m | € 11.87 | € 13.64 | € 15.69 |
| | | | 4.04 | 16721 | 15481 | 31350 | 21234 | m | € 11.87 | € 13.64 | € 15.69 |
| | | | 5.04 | 16722 | 15482 | 31351 | 21235 | m | € 11.87 | € 13.64 | € 15.69 |
| | | | 7.04 | 16723 | 15483 | 31353 | 21237 | m | € 11.87 | € 13.64 | € 15.69 |

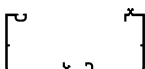
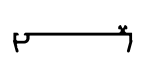
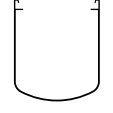
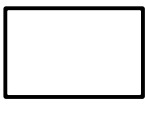
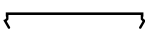
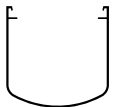
| GROUP | TYPE | DESCRIPTION | LENGTH | ARTICLE NUMBER | | | | UN. | PRICE / UNIT | | |
|---|--------|---|--------|----------------|-------|---------|-------|-----|--------------|------------------|----------|
| P | POSTS | | M | 0 | 9010 | 7016 ST | RAL | | 0 | STANDARD COLOURS | RAL * |
|  | PX | Post Climalux 110/141 for gutter GX | 2.54 | 34882 | 34884 | 34886 | 34888 | m | € 47.01 | € 55.34 | € 63.64 |
| | | | 3.29 | 34883 | 34885 | 34887 | 34889 | m | € 47.01 | € 55.34 | € 63.64 |
| | | | 5.04 | 62710 | | 62712 | 62711 | m | € 47.01 | € 55.34 | € 63.64 |
|  | PXLX | Post part Climalux 150/120 for gutter GX/GXLX | 2.54 | 69700 | 69703 | 69702 | 69701 | m | € 78.20 | € 89.92 | € 103.41 |
| | | | 3.29 | 69704 | 69707 | 69706 | 69705 | m | € 78.20 | € 89.92 | € 103.41 |
|  | PCLX | Post clip 150/30 for PXLX and gutter GX | 2.54 | 69722 | 69725 | 69724 | 69723 | m | € 30.60 | € 35.18 | € 40.46 |
| | | | 3.29 | 69726 | 69729 | 69728 | 69727 | m | € 30.60 | € 35.18 | € 40.46 |
|  | PCLXLX | Post clip 150/60 for PXLX and gutter GXLX | 2.54 | 69711 | 69714 | 69713 | 69712 | m | € 37.22 | € 42.82 | € 49.24 |
| | | | 3.29 | 69715 | 69718 | 69717 | 69716 | m | € 37.22 | € 42.82 | € 49.24 |
|  | PGDX | Post Climalux 110/110 for cross-beam GDx | 2.54 | 35169 | 35171 | 35173 | 35175 | m | € 61.57 | € 68.10 | € 78.32 |
| | | | 3.29 | 35170 | 35172 | 35174 | 35176 | m | € 61.57 | € 68.10 | € 78.32 |
| | | | 5.04 | 41505 | 41509 | 41511 | 41551 | m | € 61.57 | € 68.10 | € 78.32 |
| | | | 6.54 | 41508 | 41510 | 41512 | 51552 | m | € 61.57 | € 68.10 | € 78.32 |
|  | P | Post part 110/50 | 2.54 | 21474 | 21478 | 31229 | 21496 | m | € 32.15 | € 36.98 | € 42.53 |
| | | | 3.29 | 21475 | 21479 | 31230 | 21497 | m | € 32.15 | € 36.98 | € 42.53 |
|  | PCB | Post clip base for PC | 2.54 | 21510 | | | | m | € 10.75 | | |
| | | | 3.29 | 21511 | | | | m | € 10.75 | | |
|  | PC | Post clip for P | 2.54 | 21472 | 21502 | 31170 | 21506 | m | € 47.73 | € 54.91 | € 63.15 |
| | | | 3.29 | 21473 | 21503 | 31171 | 21507 | m | € 47.73 | € 54.91 | € 63.15 |
|  | P72 | Post 72/110 | 2.54 | 35660 | 35664 | 35662 | 35666 | m | € 54.41 | € 63.24 | € 72.73 |
| | | | 3.29 | 35661 | 35665 | 35663 | 35667 | m | € 54.41 | € 63.24 | € 72.73 |
| | | | 5.04 | 54993 | 58499 | 58497 | 58495 | m | € 54.41 | € 63.24 | € 72.73 |
| | | | 6.54 | 54994 | 58500 | 58498 | 58496 | m | € 54.41 | € 63.24 | € 72.73 |
|  | PCB72 | Clip for side cover PC72 | 2.54 | 45376 | | | | m | € 12.98 | | |
| | | | 3.29 | 45377 | | | | m | € 12.98 | | |
|  | PC72 | Water drainage cover for P72 | 2.54 | 35668 | 35673 | 35671 | 35675 | m | € 42.12 | € 53.96 | € 62.05 |
| | | | 3.29 | 35669 | 35674 | 35672 | 35676 | m | € 42.12 | € 53.96 | € 62.05 |
| | | | 5.04 | 58501 | 58507 | 58505 | 58503 | m | € 42.12 | € 53.96 | € 62.05 |
| | | | 6.54 | 58502 | 58508 | 58506 | 58504 | m | € 42.12 | € 53.96 | € 62.05 |

FINISHING

0: mill-finished aluminium or standard

RAL 9010 white / RAL 7016 ST anthracite structure: in stock (delivery time max. 3 weeks)

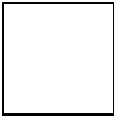

Other standard RAL colours: start up costs of € 200 net for each colour (delivery time max. 4 weeks)

* any other RAL colour: +15% and start up cost of € 200 net for each colour (delivery time max. 4 weeks)

| GROUP | TYPE | DESCRIPTION | LENGTH | ARTICLE NUMBER | | | UN. | PRICE / UNIT | | | |
|---|-------|--------------|--------|----------------|-------|---------|-------|--------------|---------|------------------|---------|
| P | POSTS | | M | O | 9010 | 7016 ST | RAL | | 0 | STANDARD COLOURS | RAL * |
| | | | | | | | | | | | |
|  | 98 | Post 50/100 | 2.54 | 10476 | 10478 | 31199 | 16059 | m | € 27.83 | € 31.97 | € 36.77 |
| | | | 3.29 | 10477 | 10479 | 31200 | 16060 | m | € 27.83 | € 31.97 | € 36.77 |
| | | | 5.04 | 8658 | 8387 | 31201 | 16061 | m | € 27.83 | € 31.97 | € 36.77 |
| | | | 6.54 | 11920 | 14047 | 31202 | 16062 | m | € 27.83 | € 31.97 | € 36.77 |
|  | 100 | Post 100/100 | 2.54 | 11907 | 11913 | 31197 | 15978 | m | € 37.27 | € 45.20 | € 51.98 |
| | | | 3.29 | 11908 | 11914 | 31198 | 15980 | m | € 37.27 | € 45.20 | € 51.98 |

| GROUP | TYPE | DESCRIPTION | LENGTH | ARTICLE NUMBER | | | UN. | PRICE / UNIT | | | |
|--|------------------------|-------------------------------------|--------|----------------|-------|---------|-------|--------------|--------|------------------|--------|
| Y | RISING PROFILES | | M | O | 9010 | 7016 ST | RAL | | 0 | STANDARD COLOURS | RAL * |
| | | | | | | | | | | | |
|  | Y10 | Adapter profile 8mm for 10mm sheet | 6.54 | 18324 | 18403 | 31163 | 21283 | m | € 3.14 | € 5.69 | € 6.54 |
| | Y32 | Adapter profile 15mm for 32mm sheet | 7.04 | 13314 | | | | m | € 4.93 | | |
| | Y16A | Raising profile alu 16mm | 3.54 | 21520 | 21524 | 31181 | 21526 | m | € 6.52 | € 7.49 | € 8.61 |
| | | | 7.04 | 21518 | 21525 | 31182 | 21527 | m | € 6.52 | € 7.49 | € 8.61 |
| Y16P | Thermal break ABS 16mm | 1 | 21528 | | | | m | € 4.54 | | | |
| | | 4 | 21529 | | | | m | € 4.54 | | | |

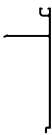
2. Finishing profiles

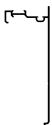
| GROUP | TYPE | DESCRIPTION | LENGTH | ARTICLE NUMBER | | | UN. | PRICE / UNIT | | | |
|---|---------------|--------------------------|--------|----------------|-------|---------|-------|--------------|---------|------------------|---------|
| A | SHEET SPACERS | | M | O | 9010 | 7016 ST | RAL | | 0 | STANDARD COLOURS | RAL * |
| | | | | | | | | | | | |
|  | AX | Sheet spacer Climalux AX | 0.942 | 34890 | 34894 | 34898 | 34902 | pc | € 21.03 | € 24.72 | € 28.43 |
| | | | 1.012 | 34891 | 34895 | 34899 | 34903 | pc | € 22.65 | € 26.65 | € 30.65 |
| | | | 1.162 | 34892 | 34896 | 34900 | 34904 | pc | € 25.94 | € 30.51 | € 35.09 |
| | | | 1.192 | 60343 | 60344 | 60345 | 60392 | pc | € 26.58 | € 31.27 | € 35.96 |
| | | | 2.5 | 61311 | 61313 | 61312 | 61314 | pc | € 55.80 | € 65.60 | € 75.44 |
|  | A1 | Sheet spacer A1 | 0.942 | 21428 | 21445 | 31174 | 21451 | pc | € 15.10 | € 17.38 | € 19.99 |
| | | | 1.012 | 21429 | 21446 | 31175 | 21452 | pc | € 16.10 | € 18.54 | € 21.32 |
| | | | 1.162 | 21430 | 21447 | 31176 | 21453 | pc | € 18.21 | € 20.97 | € 24.12 |
| | | | 1.192 | 21431 | 21448 | 31177 | 21454 | pc | € 18.48 | € 21.25 | € 24.44 |
| | | | 2.5 | 61303 | 61305 | 61304 | 61306 | pc | € 32.88 | € 37.80 | € 43.47 |
|  | A2 | Sheet spacer A2 | 0.942 | 31404 | 31412 | 31416 | 31420 | pc | € 18.10 | € 22.53 | € 25.91 |
| | | | 1.012 | 31405 | 31413 | 31417 | 31421 | pc | € 19.49 | € 24.21 | € 27.84 |
| | | | 1.162 | 31406 | 31414 | 31418 | 31422 | pc | € 22.31 | € 27.79 | € 31.96 |
| | | | 1.192 | 31407 | 31415 | 31419 | 31423 | pc | € 22.90 | € 28.50 | € 32.78 |
| | | | 2.5 | 61307 | 61309 | 61308 | 61310 | pc | € 48.02 | € 59.78 | € 68.75 |

FINISHING





O: mill-finished aluminium or standard



RAL 9010 white / RAL 7016 ST anthracite structure: in stock (delivery time max. 3 weeks)



Other standard RAL colours: start up costs of € 200 net for each colour (delivery time max. 4 weeks)

* any other RAL colour: +15% and start up cost of € 200 net for each colour (delivery time max. 4 weeks)

ACCESSORIES FOR SELF-SUPPORTING SYSTEMS

| GROUP | TYPE | DESCRIPTION | LENGTH | ARTICLE NUMBER | | | | UN. | PRICE / UNIT | | | |
|-----------|---|-------------|---------------------------|----------------|-------------|----------------|------------|-------|--------------|-------------------------|--------------|---------|
| CC | CLIMACROWN | | M | 0 | 9010 | 7016 ST | RAL | | 0 | STANDARD COLOURS | RAL * | |
| | | | | | | | | | | | | |
| |  | CC150 | Stack profile 150mm | 5.04 | 48048 | 48051 | 48050 | 48049 | m | € 28.29 | € 36.28 | € 41.72 |
| | | | | 7.04 | 48052 | 48055 | 48054 | 48053 | m | € 28.29 | € 36.28 | € 41.72 |
| |  | CC225 | Stack profile 225mm | 5.04 | 48062 | 48065 | 48064 | 48063 | m | € 50.97 | € 61.98 | € 71.28 |
| | | | | 7.04 | 48066 | 48069 | 48068 | 48067 | m | € 50.97 | € 61.98 | € 71.28 |
| |  | CCL | Corner profile Climacrown | 1.53 | 48071 | 48073 | 48074 | 48072 | m | € 22.62 | € 29.04 | € 33.40 |
| |  | CCU | Edge profile Climacrown | 5.04 | 44887 | 44891 | 44893 | 44889 | m | € 5.54 | € 8.37 | € 9.63 |
| | | | | 7.04 | 44888 | 44892 | 44894 | 44890 | m | € 5.54 | € 8.37 | € 9.63 |

| GROUP | TYPE | DESCRIPTION | LENGTH | ARTICLE NUMBER | | | | UN. | PRICE / UNIT | | | |
|---|------------------------------|----------------------------|---|----------------|---|----------------|------------|-------|--------------|-------------------------|--------------|--------|
| TR | PROFILES FOR TRIANGLE | | M | 0 | 9010 | 7016 ST | RAL | | 0 | STANDARD COLOURS | RAL * | |
| | | | | | | | | | | | | |
| | | |  | TRB | Base profile for triangle 25mm for glass 10mm | 5.2 | 47739 | 47742 | 47741 | 47740 | m | € 8.62 |
|  | TRC | Clips profile for triangle | 5.2 | 47735 | 47738 | 47737 | 47736 | m | € 4.02 | € 5.98 | € 6.88 | |

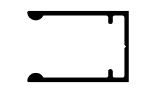
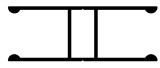
| GROUP | TYPE | DESCRIPTION | LENGTH | ARTICLE NUMBER | | | | UN. | PRICE / UNIT | | | |
|----------|---|-------------|--|----------------|-------------|----------------|------------|-------|--------------|-------------------------|--------------|---------|
| W | PROFILES FOR TRIANGLE AND SIDE WALLS | | M | 0 | 9010 | 7016 ST | RAL | | 0 | STANDARD COLOURS | RAL * | |
| | | | | | | | | | | | | |
| |  | WB | Base profile for triangle and side wall 42mm for glass 10mm or PC 16mm | 5.04 | 65849 | 65852 | 65851 | 65850 | m | € 13.18 | € 15.55 | € 17.88 |
| | | | | 7.04 | 65853 | 65856 | 65855 | 65854 | m | | | |
| |  | WC | Clips profile for WB | 5.04 | 65857 | 65860 | 65859 | 65858 | m | € 4.81 | € 5.98 | € 6.88 |
| | | | | 7.04 | 65861 | 65864 | 65863 | 65862 | m | | | |
| |  | WU | Side profile U for triangle or side wall | 1.5 | 65865 | 65868 | 65867 | 65866 | m | € 6.52 | € 8.14 | € 9.36 |
| | | | | 3.04 | 65869 | 65872 | 65871 | 65870 | m | | | |
| |  | H | Profile H for triangle or side wall | 3 | 46426 | 71948 | 71949 | 71947 | m | € 12.77 | € 14.69 | € 16.89 |
| | | | | 4 | 46427 | | | | m | | | |
| 7 | | | | 46428 | | | | m | | | | |

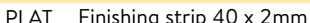
| GROUP | TYPE | DESCRIPTION | LENGTH | ARTICLE NUMBER | | | | UN. | PRICE / UNIT | | | |
|----------|------------------------|-------------|---|----------------|--------------------------|----------------|------------|--------|--------------|-------------------------|--------------|--------|
| - | FINISHING STRIP | | M | 0 | 9010 | 7016 ST | RAL | | 0 | STANDARD COLOURS | RAL * | |
| | | | | | | | | | | | | |
| | | |  | PLAT | Finishing strip 40 x 2mm | 3 | 103544 | 103547 | 103546 | 103545 | m | € 3.89 |
| 6 | 81026 | 81028 | | | | 81027 | 81519 | m | | | | |



FINISHING

0: mill-finished aluminium or standard





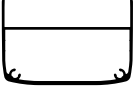



RAL 9010 white / RAL 7016 ST anthracite structure: in stock (delivery time max. 3 weeks)

Other standard RAL colours: start up costs of € 200 net for each colour (delivery time max. 4 weeks)

* any other RAL colour: +15% and start up cost of € 200 net for each colour (delivery time max. 4 weeks)

| GROUP | TYPE | DESCRIPTION | LENGTH | ARTICLE NUMBER | | | UN. | PRICE / UNIT | | | | |
|------------|---------------------------------------|---|--|----------------|-------------|----------------|------------|--------------|-------------------------|--------------|---------|---------|
| L | FINISHING PROFILES FOR SCREENS | | M | 0 | 9010 | 7016 ST | RAL | 0 | STANDARD COLOURS | RAL * | | |
| | |  L1342 | L-adapter profile for screen | 4 | 71725 | 71728 | 71727 | 71726 | m | € 15.65 | € 18.00 | € 20.70 |
| | | | Always use with profile L432 | 5 | 71729 | 71732 | 71731 | 71730 | m | | | |
| | | | | 6 | 71733 | 71736 | 71735 | 71734 | m | | | |
| LED | PROFILES FOR LED SPOTS | | M | 0 | 9010 | 7016 ST | RAL | 0 | STANDARD COLOURS | RAL * | | |
| | |  LED | Profiles for LED spots not pre-drilled | 4.2 | 39503 | 39544 | 39532 | 51579 | m | € 17.61 | € 22.43 | € 25.79 |
| | | | | 5.25 | 39504 | 39545 | 39533 | 51580 | m | | | |
| | | | | 5.97 | 39514 | 39546 | 39534 | 51581 | m | | | |
| | |  KG | Base profile cable tray for LED spots | 5.04 | 81798 | 81801 | 81800 | 81799 | m | € 15.95 | € 18.33 | € 21.08 |
| | | | | 7.04 | 81802 | 81805 | 81804 | 81803 | m | | | |
| | |  KGC | Clip profile for cable tray | 5.04 | 81806 | 81809 | 81808 | 81807 | m | € 3.14 | € 5.61 | € 6.45 |
| | | | | 7.04 | 81810 | 81813 | 81812 | 81811 | m | | | |









3. Rubbers** and clip profiles



| GROUP | TYPE | DESCRIPTION | LENGTH | ARTICLE NUMBER | | | UN. | PRICE / UNIT | | | |
|--|-------------------------------------|--|--|----------------|-------------|--------------|-------|--------------|-------------|--------------|--------|
| C | RUBBERS | | M | WHITE | GREY | BLACK | | WHITE | GREY | BLACK | |
| | |  C1CX | Coextruder for wall top white/black | 35 | 17701 | | | m | € 4.75 | | |
| | | | Coextruder for wall top grey/black | 35 | | 17703 | | m | | € 4.75 | |
| | |  C12 | Support thread for C1CX | 200 | | 23875 | | m | | € 0.78 | |
| | |  C2CX | Coextruder white/black for TP - TPG - TPGL | 2 x 24 | 18316 | 18315 | | m | € 6.19 | € 6.19 | |
| | | | Coextruder grey/black for TP - TPG - TPGL | 35 | 15471 | 17697 | | m | € 6.19 | € 6.19 | |
| | | | | 50 | 15472 | 17698 | | m | € 6.19 | € 6.19 | |
| | |  C3 | Rubber for sheet spacer AX grey | 100 | | 13319 | | m | | € 1.11 | |
| | |  C4CX | Coextruder for MX32 white/black | 35 | 17700 | | | m | € 5.70 | | |
| | | | Coextruder for MX32 grey/black | 35 | | 15475 | | m | | € 5.70 | |
| | |  C5 | Rubber for sheet spacer A1-A2 grey | 100 | | 8417 | | m | | € 2.85 | |
| | |  C7 | Rubber black for WB -10mm | 100 | | | 65895 | m | | | € 2.79 |
|  C8 | Rubber grey for CL16, CL32 and CLSB | 300 | | 13328 | | m | | € 1.48 | | | |
| | Rubber black for TRB & WB 16mm | 300 | | | 23803 | m | | | € 1.48 | | |

** Roll length. The rubber sealings are also available in multiple profile lengths.

FINISHING | 0: mill-finished aluminium or standard
 RAL 9010 white / RAL 7016 ST anthracite structure: in stock (delivery time max. 3 weeks)
 Other standard RAL colours: start up costs of € 200 net for each colour (delivery time max. 4 weeks)
 * any other RAL colour: +15% and start up cost of € 200 net for each colour (delivery time max. 4 weeks)

ACCESSORIES FOR SELF-SUPPORTING SYSTEMS

| GROUP | TYPE | DESCRIPTION | LENGTH | ARTICLE NUMBER | | | | UN. | PRICE / UNIT | | |
|----------|---|--|----------|----------------|------|-------|-------|-----|--------------|--------|--|
| | | | | WHITE | GREY | BLACK | WHITE | | GREY | BLACK | |
| C | RUBBERS | | M | | | | | | | | |
| |  | CY10 Rubber grey for CL16, CL32 and CLSB | 50 | | | 29509 | | m | | € 4.20 | |
| |  | C11CX Coextruded rubber gutter/ridge white/black | 50 | 21557 | | | | m | € 9.46 | | |
| |  | C14 Clip rubber for TRC glass 10mm | 50 | | | 25858 | | m | | € 2.58 | |
| |  | C17 Rubber black for WC -10mm | 50 | | | 72045 | | m | | € 2.87 | |
| |  | C18 Rubber black for WC -16mm | 50 | | | 72044 | | m | | € 2.45 | |
| |  | C27 Rubber black for WU / WH -10mm | 50 | | | 72135 | | m | | € 1.86 | |
| |  | C31 Support rubber for glass | 200 | | | 28805 | | m | | € 4.87 | |
| |  | H Seal H-profile outside | pc | | | 82565 | | pc | | € 4.17 | |
| |  | C18-60 Seal C18 60mm H-profile inside | pc | | | 94659 | | pc | | € 0.31 | |

| GROUP | TYPE | DESCRIPTION | LENGTH | ARTICLE NUMBER | | | | UN. | PRICE / UNIT | | |
|-----------|---|------------------------------|----------|----------------|--------|---------|-------|---------|--------------|------------------|---------|
| | | | | 0 | 9010 | 7016 ST | RAL | | 0 | STANDARD COLOURS | RAL * |
| CL | CLIP PROFILES | | M | | | | | | | | |
| |  | CL16 Clip alu 16mm | 2.04 | 13329 | 13336 | 31234 | 16063 | m | € 11.71 | € 13.47 | € 15.49 |
| | | | 2.54 | 13330 | 13337 | 31235 | 16064 | m | € 11.71 | € 13.47 | € 15.49 |
| | | | 3.04 | 13331 | 13338 | 31236 | 16065 | m | € 11.71 | € 13.47 | € 15.49 |
| | | | 3.54 | 13332 | 13339 | 31237 | 16066 | m | € 11.71 | € 13.47 | € 15.49 |
| | | | 4.04 | 13333 | 13340 | 31238 | 16067 | m | € 11.71 | € 13.47 | € 15.49 |
| | | | 5.04 | 13824 | 13928 | 31239 | 16070 | m | € 11.71 | € 13.47 | € 15.49 |
| | | | 6.04 | 13334 | 13341 | 31240 | 16071 | m | € 11.71 | € 13.47 | € 15.49 |
| |  | CL32 Clip alu 25/32mm | 7.04 | 13335 | 13342 | 31241 | 16072 | m | € 11.71 | € 13.47 | € 15.49 |
| | | | 2.04 | 13350 | 13352 | 31242 | 16073 | m | € 14.89 | € 17.12 | € 19.69 |
| | | | 2.54 | 13351 | 13353 | 31243 | 16074 | m | € 14.89 | € 17.12 | € 19.69 |
| | | | 3.04 | 13154 | 13159 | 31244 | 16075 | m | € 14.89 | € 17.12 | € 19.69 |
| | | | 3.54 | 13155 | 13160 | 31245 | 16076 | m | € 14.89 | € 17.12 | € 19.69 |
| | | | 4.04 | 13156 | 13161 | 31246 | 16088 | m | € 14.89 | € 17.12 | € 19.69 |
| | | | 5.04 | 14372 | 14373 | 31247 | 16089 | m | € 14.89 | € 17.12 | € 19.69 |
| |  | CLLX Side clip Climalux 16mm | 6.04 | 13157 | 13162 | 31248 | 16091 | m | € 14.89 | € 17.12 | € 19.69 |
| | | | 7.04 | 13158 | 13163 | 31249 | 16092 | m | € 14.89 | € 17.12 | € 19.69 |
| | | | 3.04 | 35705 | 35710 | 35715 | 35720 | m | € 19.14 | € 21.92 | € 25.21 |
| | | | 3.54 | 35706 | 35711 | 35716 | 35721 | m | € 19.14 | € 21.92 | € 25.21 |
| | | | 4.04 | 35707 | 35712 | 35717 | 35722 | m | € 19.14 | € 21.92 | € 25.21 |
| | | 5.04 | 35708 | 35713 | 35718 | 35723 | m | € 19.14 | € 21.92 | € 25.21 | |
| | | 6.04 | 109183 | 109185 | 109186 | 109184 | m | € 19.14 | € 21.92 | € 25.21 | |





FINISHING





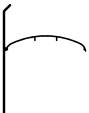

0: mill-finished aluminium or standard

RAL 9010 white / RAL 7016 ST anthracite structure: in stock (delivery time max. 3 weeks)

Other standard RAL colours: start up costs of € 200 net for each colour (delivery time max. 4 weeks)

* any other RAL colour: +15% and start up cost of € 200 net for each colour (delivery time max. 4 weeks)

| GROUP | TYPE | DESCRIPTION | LENGTH | ARTICLE NUMBER | | | UN. | PRICE / UNIT | | | |
|--|---|-------------------------------------|------------------------|----------------|-------|---------|-------|--------------|------------------|---------|---------|
| CL | CLIP PROFILES | | M | 0 | 9010 | 7016 ST | RAL | 0 | STANDARD COLOURS | RAL * | |
| |  | CLL | Side clip 16, 25, 32mm | 2.04 | 17713 | 17740 | 31354 | 21174 | m | € 20.72 | € 23.82 |
| 2.54 | | | | 17714 | 17741 | 31355 | 21175 | m | € 20.72 | € 23.82 | € 27.39 |
| 3.04 | | | | 17715 | 17742 | 31356 | 21176 | m | € 20.72 | € 23.82 | € 27.39 |
| 3.54 | | | | 17716 | 17743 | 31357 | 21177 | m | € 20.72 | € 23.82 | € 27.39 |
| 4.04 | | | | 17717 | 17744 | 31358 | 21178 | m | € 20.72 | € 23.82 | € 27.39 |
| 5.04 | | | | 17718 | 17745 | 31359 | 21179 | m | € 20.72 | € 23.82 | € 27.39 |
| 6.04 | | | | 17712 | 17728 | 31360 | 21180 | m | € 20.72 | € 23.82 | € 27.39 |
|  | CLSB | Base screwable clip from 8 til 34mm | 4.04 | 23914 | | | | m | € 8.34 | | |
| | | | 5.04 | 23915 | | | | m | € 8.34 | | |
| | | | 6.04 | 23916 | | | | m | € 8.34 | | |
| | | | 7.04 | 23917 | | | | m | € 8.34 | | |
|  | CLST | Top screwable clip | 4.04 | 23922 | 23938 | 31251 | 23946 | m | € 5.95 | € 6.82 | € 7.84 |
| | | | 5.04 | 23923 | 23939 | 31252 | 23947 | m | € 5.95 | € 6.82 | € 7.84 |
| | | | 6.04 | 23924 | 23940 | 31253 | 23948 | m | € 5.95 | € 6.82 | € 7.84 |
| | | | 7.04 | 23925 | 23941 | 31254 | 23949 | m | € 5.95 | € 6.82 | € 7.84 |
|  | CLSL | Top screwable sideclip | 4.04 | 25012 | 25024 | 31286 | 25028 | m | € 18.84 | € 21.66 | € 24.91 |
| | | | 5.04 | 25013 | 25025 | 31287 | 25029 | m | € 18.84 | € 21.66 | € 24.91 |
| | | | 6.04 | 25014 | 25026 | 31288 | 25030 | m | € 18.84 | € 21.66 | € 24.91 |
| | | | 7.04 | 25015 | 25027 | 31289 | 25031 | m | € 18.84 | € 21.66 | € 24.91 |
|  | GVT | Top profile for glass connector | 2 | 61297 | 61300 | 61298 | 61301 | m | € 6.11 | € 8.95 | € 10.29 |
|  | GVB | Bottom profile for glass connector | 2 | 61293 | 61296 | 61294 | 61302 | m | € 6.73 | € 10.45 | € 12.02 |

| GROUP | TYPE | DESCRIPTION | LENGTH | ARTICLE NUMBER | | | UN. | PRICE / UNIT | | | |
|---|---|-------------------------------------|-------------------------------------|----------------|-------|---------|-------|--------------|------------------|---------|---------|
| U - L | END PIECES FOR GLAZING | | M | 0 | 9010 | 7016 ST | RAL | 0 | STANDARD COLOURS | RAL * | |
| |  | U16P | Reinforced PVC end piece 16mm white | 0.98 | | 13383 | | | pc | € 4.82 | |
| 1.053 | | | | | 13384 | | | pc | € 5.20 | | |
| 1.2 | | | | | 13385 | | | pc | € 5.90 | | |
| 1.25 | | | | | 13386 | | | pc | € 6.19 | | |
| 6.4 | | | | | 13396 | | | pc | € 31.56 | | |
|  | U25P | Reinforced PVC end piece 25mm white | 1.2 | | 13397 | | | pc | € 7.39 | | |
| | | | 2.1 | | 35375 | | | pc | € 12.95 | | |
| | | | 5 | | 13441 | | | pc | € 30.82 | | |
|  | U32P | Reinforced PVC end piece 32mm white | 0.98 | | 17874 | | | pc | € 6.90 | | |
| | | | 1.053 | | 27249 | | | pc | € 7.44 | | |
| | | | 1.23 | | 13400 | | | pc | € 8.48 | | |
| | | | 1.25 | | 13401 | | | pc | € 8.64 | | |
| | | | 5 | | 13440 | | | pc | € 34.48 | | |
|  | U16A | Alu end piece 16mm | 0.98 | 13406 | | | | pc | € 5.39 | | |
| | | | 1.053 | 13407 | | | | pc | € 5.84 | | |
| | | | 1.2 | 13408 | | | | pc | € 6.62 | | |
| | | | 6.5 | 18321 | | | | pc | € 35.83 | | |
|  | U32A | Alu end piece 32mm | 1.23 | 13469 | | | 15917 | pc | € 9.68 | € 15.33 | |
|  | U16 | Pre-drilled alu end piece 16mm | 0.98 | 23553 | 23569 | 31183 | 23565 | pc | € 9.75 | € 12.94 | € 14.88 |
| | | | 1.053 | 23554 | 23570 | 31184 | 23566 | pc | € 10.45 | € 12.94 | € 14.88 |
| | | | 1.2 | 23555 | 23571 | 31185 | 23567 | pc | € 11.92 | € 15.45 | € 17.77 |
| | | | 6.1 | 23556 | 23572 | 31186 | 23568 | pc | € 65.22 | € 85.72 | € 98.58 |
|  | U32 | Pre-drilled alu end piece 32mm | 0.98 | 27239 | 27245 | 31396 | 27243 | pc | € 12.35 | € 15.93 | € 18.32 |
| | | | 1.23 | 21534 | 21552 | 31195 | 21555 | pc | € 15.12 | € 19.49 | € 22.41 |
| | | | 5 | 21535 | 21553 | 31196 | 21556 | pc | € 61.48 | € 79.24 | € 91.13 |

FINISHING

0: mill-finished aluminium or standard

RAL 9010 white / RAL 7016 ST anthracite structure: in stock (delivery time max. 3 weeks)

Other standard RAL colours: start up costs of € 200 net for each colour (delivery time max. 4 weeks)

* any other RAL colour: +15% and start up cost of € 200 net for each colour (delivery time max. 4 weeks)

| GROUP | TYPE | DESCRIPTION | LENGTH | ARTICLE NUMBER | | | | UN. | PRICE / UNIT | | |
|---|-------------------------------|---|--------|----------------|----------|-------------|----------------|------------|--------------|-------------------------|--------------|
| U - L  | END PIECES FOR GLAZING | | | M | 0 | 9010 | 7016 ST | RAL | 0 | STANDARD COLOURS | RAL * |
| | U55 | Pre-drilled alu end piece 55mm | 1.23 | 69742 | 69744 | 69743 | | pc | € 18.28 | € 23.38 | |
| | L432 | L obturator profile L for finish side rafter L for finish vertical screen | 6 | 23529 | 23552 | 31160 | 23551 | m | € 8.26 | € 9.50 | € 10.93 |
| | L632 | L obturator profile | 7.04 | 27224 | 27227 | 31161 | 27228 | m | € 11.95 | € 15.23 | € 17.51 |
| | TOCHT10 | Water block profile PVC for glass 8-10mm black length 2500mm | pc | 106062 | | | | pc | € 35.77 | | |

4. Accessories

| GROUP | TYPE | DESCRIPTION | QUANT. | ARTICLE NUMBER | | | | UN. | PRICE / UNIT | | |
|---|-------------------------------------|---|--------|----------------|----------|-------------|----------------|------------|--------------|-------------------------|--------------|
| S  | END PIECES AND STOP PROFILES | | | | 0 | 9010 | 7016 ST | RAL | 0 | STANDARD COLOURS | RAL * |
| | GASX | End piece gutter Climalux for GX | pc | 34948 | 34949 | 34950 | 34951 | pc | € 13.37 | € 15.76 | € 18.12 |
| | GLSX | End piece gutter Climalux for GX + GLX | pc | 34952 | 34953 | 34954 | 34955 | pc | € 14.01 | € 16.96 | € 19.50 |
| | GRSX | End piece gutter for GX + GR | pc | 34956 | 34957 | 34958 | 34959 | pc | € 16.52 | € 20.05 | € 23.06 |
| | GASXL | End piece gutter Climalux for GXLX standard | pc | 71888 | 71891 | 71890 | 71889 | pc | € 26.04 | € 29.94 | € 34.43 |
| | GASXL | End piece gutter Climalux for GXLX left with Skylux logo (left: seen from the inside) | pc | 71892 | 71895 | 71894 | 71893 | pc | € 26.04 | € 29.94 | € 34.43 |
| | GASXL | End piece gutter Climalux for GXLX right with Skylux logo (right: seen from the inside) | pc | 71896 | 71899 | 71898 | 71897 | pc | € 26.04 | € 29.94 | € 34.43 |
| | GDSX | End piece Climalux for cross-beam GDx | pc | 35149 | 35150 | 35151 | 35152 | pc | € 6.46 | € 15.63 | € 17.97 |









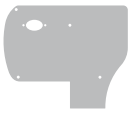

FINISHING

0: mill-finished aluminium or standard

RAL 9010 white / RAL 7016 ST anthracite structure: in stock (delivery time max. 3 weeks)

Other standard RAL colours: start up costs of € 200 net for each colour (delivery time max. 4 weeks)











* any other RAL colour: +15% and start up cost of € 200 net for each colour (delivery time max. 4 weeks)

| GROUP | TYPE | DESCRIPTION | QUANT. | ARTICLE NUMBER | | | | UN. | PRICE / UNIT | | |
|---|---|--|-----------------------------|----------------|-------|---------|-------|-------|--------------|------------------|---------|
| S | END PIECES AND STOP PROFILES | | | 0 | 9010 | 7016 ST | RAL | | 0 | STANDARD COLOURS | RAL * |
| |  | GAS1 | End piece gutter for G + GD | pc | 21543 | 21540 | 31259 | 21544 | pc | € 13.97 | € 16.06 |
|  | GAS2 | End piece gutter for GD | pc | 21579 | 21581 | 31260 | 21582 | pc | € 12.17 | € 17.73 | € 20.39 |
|  | GAS3 | End piece gutter for GD2 + G | pc | 23737 | 23739 | 31271 | 27363 | pc | € 36.75 | € 52.86 | € 60.79 |
|  | GAS4 | End piece gutter for GDG | pc | 29939 | 29942 | 31269 | 29941 | pc | € 31.52 | € 38.68 | € 44.48 |
|  | G120AS | End piece gutter for G120A | pc | 21310 | 13306 | 47198 | 21588 | pc | € 3.94 | € 9.07 | € 10.43 |
|  | GDCA | End piece for GDC | pc | 27359 | 27362 | 31274 | 27361 | pc | € 14.47 | € 22.57 | € 25.96 |
|  | GRS1 | End piece for GR on G120A | pc | 17832 | 17835 | 47596 | 21598 | pc | € 26.61 | € 32.02 | € 32.67 |
|  | GRS2 | End piece gutter for G + GD + GR | pc | 21584 | 21586 | 31261 | 21587 | pc | € 28.03 | € 36.53 | € 42.01 |
|  | GRS3 | End piece gutter for GD2 + G + GR | pc | 27364 | 27367 | 31272 | 27366 | pc | € 47.04 | € 65.72 | € 75.58 |
|  | GAP1 | Thermal end piece for GD1 | pc | 22379 | | | | pc | € 17.21 | | |
|  | GAP2 | Thermal end piece for GD2 | pc | 27337 | | | | pc | € 21.84 | | |
|  | MASX | End piece wall profile Climalux for MX | pc | 34968 | 34969 | 34970 | 34971 | pc | € 4.73 | € 10.56 | € 12.14 |

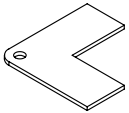
FINISHING

0: mill-finished aluminium or standard
 RAL 9010 white / RAL 7016 ST anthracite structure: in stock (delivery time max. 3 weeks)
 Other standard RAL colours: start up costs of € 200 net for each colour (delivery time max. 4 weeks)
 * any other RAL colour: +15% and start up cost of € 200 net for each colour (delivery time max. 4 weeks)

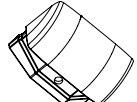
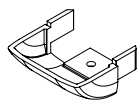
ACCESSORIES FOR SELF-SUPPORTING SYSTEMS

| GROUP | TYPE | DESCRIPTION | QUANT. | ARTICLE NUMBER | | | | UN. | PRICE / UNIT | | |
|---|---|---|--|----------------|-------|---------|-------|-------|--------------|------------------|---------|
| S | END PIECES AND STOP PROFILES | | | 0 | 9010 | 7016 ST | RAL | | 0 | STANDARD COLOURS | RAL * |
| |  | MASX32 | End piece wall profile Climalux for MX32 | pc | 60394 | 60396 | 60397 | 60395 | pc | € 5.42 | € 12.12 |
|  | MAS | End piece wall profile Climax for MT + MB | pc | 21589 | 21591 | 31275 | 21592 | pc | € 12.95 | € 14.89 | € 17.12 |
|  | NASZ | End piece ridge saddle roof | pc | 23876 | 23878 | 31276 | 23879 | pc | € 24.71 | € 28.43 | € 32.69 |
|  | ZDCS | End piece for side cover | pc | 21217 | 21569 | 31258 | 21570 | pc | € 4.57 | € 6.12 | € 7.04 |
|  | CCLAS | End piece for corner profile CCL | pc | 48081 | 48083 | 48084 | 48082 | pc | € 6.29 | € 9.87 | € 11.35 |
|  | S16X | Stop Climalux for DX | pc | 34960 | 34961 | 34962 | 34963 | pc | € 6.49 | € 9.84 | € 11.32 |
|  | S16.3 | Stop 16/3 for TP - TPG | pc | 21218 | 21562 | 31255 | 21563 | pc | € 3.19 | € 5.19 | € 5.97 |
|  | S32.3 | Stop 32/3 for TP - TPG | pc | 21220 | 21566 | 31256 | 21567 | pc | € 3.34 | € 5.54 | € 6.37 |
|  | S38.3 | Stop 38/3 for TP - TPG with glass | pc | 25079 | 25082 | 31257 | 25083 | pc | € 5.08 | € 5.83 | € 6.70 |
|  | LEDESX | End piece for LED profile Climalux | pc | 61249 | 61251 | 61252 | 61250 | pc | € 13.52 | € 16.08 | € 18.49 |
|  | LEDES | End piece for LED profile Climax | pc | 39654 | 39689 | 39688 | 39666 | pc | € 13.52 | € 16.08 | € 18.49 |
|  | KGAS | End piece for cable tray | pc | 81814 | 81816 | 81817 | 81815 | pc | € 8.53 | € 11.79 | € 13.56 |



FINISHING

0: mill-finished aluminium or standard

RAL 9010 white / RAL 7016 ST anthracite structure: in stock (delivery time max. 3 weeks)

Other standard RAL colours: start up costs of € 200 net for each colour (delivery time max. 4 weeks)

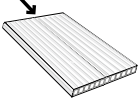
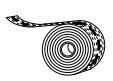
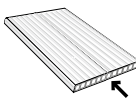
* any other RAL colour: +15% and start up cost of € 200 net for each colour (delivery time max. 4 weeks)







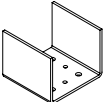

| GROUP | TYPE | DESCRIPTION | LENGTH | ARTICLE NUMBER | | | | UN. | PRICE / UNIT | | |
|---|--|---|--------|----------------|------|---------|-----|----------|--------------|------------------|-------|
| | | | | 0 | 9010 | 7016 ST | RAL | | 0 | STANDARD COLOURS | RAL * |
| B | TAPES | BT16 Closed synthetic tape for 10 and 16mm sheets With guarantee | 10 | 14408 | | | | pc | € 11.10 | | |
| | | | 33 | 82953 | | | | pc | € 23.65 | | |
| | | | 10 | 14411 | | | | pc | € 12.64 | | |
| | | | 33 | 82954 | | | | pc | € 23.43 | | |
|  | BT32 Closed synthetic tape for 32mm sheets With guarantee | 10 | 14413 | | | | pc | € 15.23 | | | |
| | | 33 | 82955 | | | | pc | € 28.32 | | | |
| | | 33 | 82956 | | | | pc | € 61.06 | | | |
| | | 10 | 13372 | | | | pc | € 20.70 | | | |
|  | BB16 Perforated synthetic tape for 16mm sheets With guarantee | 33 | 13373 | | | | pc | € 49.64 | | | |
| | | 10 | 14416 | | | | pc | € 27.42 | | | |
| | | 33 | 14424 | | | | pc | € 64.67 | | | |
| | | 10 | 13374 | | | | pc | € 35.67 | | | |
|  | BB32 Perforated synthetic tape for 32mm sheets With guarantee | 33 | 13376 | | | | pc | € 85.31 | | | |
| | | 33 | 60353 | | | | pc | € 147.84 | | | |
| | | 8 | 73799 | | | | pc | € 33.03 | | | |
| | | BANDV One-sided adhesive tape 12 x 3-7mm for triangle profile | | | | | | | | | |
|  | BANDM1 Self adhesive sealing EPDM 6 x 15mm | 10 | 94665 | | | | pc | € 24.02 | | | |
| | | m | 30517 | | | | m | € 2.80 | | | |
| | | 5 | 94664 | | | | pc | € 57.86 | | | |
| | | BANDM1 Self adhesive sealing PVC tape 20 x 30mm | | | | | | | | | |

| GROUP | TYPE | DESCRIPTION | QUANT. | ARTICLE NUMBER | | | | UN. | PRICE / UNIT | | | |
|-----------|----------------------|---------------------|---|----------------|-------|---------|-------|-------|--------------|------------------|---------|---------|
| | | | | 0 | 9010 | 7016 ST | RAL | | 0 | STANDARD COLOURS | RAL * | |
| MT | MOUNTING ACCESSORIES | 909 Connecting pins | pc | 8434 | | | | pc | € 0.99 | | | |
| | | | GDC Gutter rafter support bracket for GD1, GD2 and GL | pc | 21193 | 21594 | 31280 | 21595 | pc | € 33.42 | € 42.50 | € 48.88 |
| | | | LGDX Fixing profile "L" for cross-beam GDX | pc | 35145 | 35146 | 35147 | 35148 | pc | € 3.29 | € 8.59 | € 9.88 |
| | | | NCZ Ridge support bracket saddle roof | pc | 23880 | | | | pc | € 62.67 | | |
| | | | PV Base-plate for post 110/50 | pc | 21599 | 21601 | 31282 | 21602 | pc | € 58.15 | € 73.17 | € 84.15 |

FINISHING

0: mill-finished aluminium or standard
 RAL 9010 white / RAL 7016 ST anthracite structure: in stock (delivery time max. 3 weeks)
 Other standard RAL colours: start up costs of € 200 net for each colour (delivery time max. 4 weeks)
 * any other RAL colour: +15% and start up cost of € 200 net for each colour (delivery time max. 4 weeks)

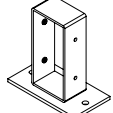
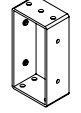
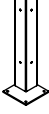
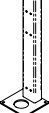
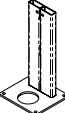
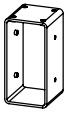
ACCESSORIES FOR SELF-SUPPORTING SYSTEMS

| GROUP | TYPE | DESCRIPTION | QUANT. | ARTICLE NUMBER | | | | UN. | PRICE / UNIT | | | |
|---|----------------------|--------------------------------------|--------|----------------|---|------|---------|-----|--------------|----------|------------------|-------|
| MT | MOUNTING ACCESSORIES | | | | 0 | 9010 | 7016 ST | RAL | | 0 | STANDARD COLOURS | RAL * |
|  | PU | U top-bottom for post P | pc | 21603 | | | | | pc | € 6.20 | | |
|  | PUX | U top-bottom for post PGDX 110/110 | pc | 35143 | | | | | pc | € 10.01 | | |
|  | PU72 | U top-bottom for post P72 | pc | 35831 | | | | | pc | € 9.39 | | |
|  | PT72 | Top-plate for post P72 | pc | 35832 | | | | | pc | € 5.63 | | |
|  | PT110 | Top-plate for post PGDX | pc | 51817 | | | | | pc | € 8.14 | | |
|  | UT10 | U top-bottom for post 100 | pc | 13582 | | | | | pc | € 21.29 | | |
|  | UT98 | U top-bottom for post 98 | pc | 13580 | | | | | pc | € 15.80 | | |
|  | GPV | Base-plate statik for post P72 | pc | 35410 | | | | | pc | € 91.39 | | |
|  | GPT | Top part statik for post P72 | pc | 35409 | | | | | pc | € 43.79 | | |
|  | PS | Post support 100 x 100 for PGDX | pc | 47792 | | | | | pc | € 157.13 | | |
|  | PS01 | Post support 60 x 100 for P72 | pc | 94528 | | | | | pc | € 159.53 | | |
|  | PS02 | Post support 30 x 140 for PXLX | pc | 94527 | | | | | pc | € 226.06 | | |
|  | C110 | Connector statik for post PGDX - GDG | pc | 48111 | | | | | pc | € 78.20 | | |
|  | C72 | Connector statik for post P72 - GDG | pc | 48113 | | | | | pc | € 73.40 | | |

FINISHING

0: mill-finished aluminium or standard

RAL 9010 white / RAL 7016 ST anthracite structure: in stock (delivery time max. 3 weeks)

Other standard RAL colours: start up costs of € 200 net for each colour (delivery time max. 4 weeks)

* any other RAL colour: +15% and start up cost of € 200 net for each colour (delivery time max. 4 weeks)

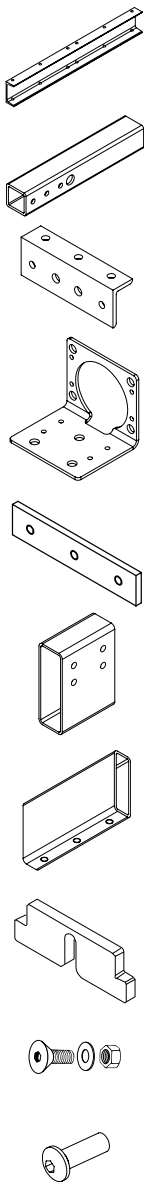
| GROUP | TYPE | DESCRIPTION | QUANT. | ARTICLE NUMBER | | | | UN. | PRICE / UNIT | | |
|--|---|---|--------|----------------|------|---------|-----|--------|--------------|------------------|-------|
| | | | | 0 | 9010 | 7016 ST | RAL | | 0 | STANDARD COLOURS | RAL * |
|  | UPN140 | Connecting profile statik for GDX | pc | 51816 | | | | pc | € 210.83 | | |
| | KO | Tube statik for GDG | pc | 35411 | | | | pc | € 34.59 | | |
| | LT150 | "L" connecting piece for post PXLX - gutter GX/GXLX | pc | 69698 | | | | pc | € 23.06 | | |
| | LB150 | "L" Bracket bottom for post PXLX | pc | 69699 | | | | pc | € 19.24 | | |
| | PT150 | Top-plate for gutter GXLX | pc | 69697 | | | | pc | € 9.09 | | |
| | VGXLX | Connecting piece for gutter GXLX | pc | 78180 | | | | pc | € 46.13 | | |
| | VS | Connecting piece for gutter GX - LT150 | pc | 93874 | | | | pc | € 26.94 | | |
| | KGBP | Mounting plate for cable tray | pc | 82564 | | | | pc | € 4.38 | | |
| | BMR | Stainless screw, nut and ring spring M8 | pc | 21607 | | | | pc | € 1.16 | | |
| | BGDG | Stainless screw M10 x 30 for posts P72 | pc | 35412 | | | | pc | € 0.90 | | |
| | BOUT | Stainless screw M10 x 120 for PGDX | pc | 82574 | | | | pc | € 3.20 | | |
| | BOUT | Stainless screw M10 x 180 for GDX | pc | 51810 | | | | pc | € 10.34 | | |
| | MOER | Stainless prevailing nut M10 | pc | 17996 | | | | pc | € 0.74 | | |
| | RING | Stainless washer M10 | pc | 46673 | | | | pc | € 0.12 | | |
| | BOUT | Stainless screw M8 x 16 for LT150 - GXLX | pc | 72910 | | | | pc | € 0.44 | | |
| | BOUT | Screw M10 x 20 for LT150 - PXLX | pc | 49641 | | | | pc | € 0.70 | | |
| | BOUT | Screw M10 x 30 | pc | 51701 | | | | pc | € 0.70 | | |
| | BOUT | Screw M10 x 60 for C72 - PXLX | pc | 82573 | | | | pc | € 2.59 | | |
| BOUT | Screw M10 x 100 for C72 - P72 | pc | 82572 | | | | pc | € 1.69 | | | |
| RING | Stainless lock washer M8 for LT150 - GXLX | pc | 72912 | | | | pc | € 0.13 | | | |

FINISHING



0: mill-finished aluminium or standard

RAL 9010 white / RAL 7016 ST anthracite structure: in stock (delivery time max. 3 weeks)

Other standard RAL colours: start up costs of € 200 net for each colour (delivery time max. 4 weeks)

* any other RAL colour: +15% and start up cost of € 200 net for each colour (delivery time max. 4 weeks)

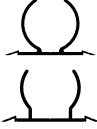
ACCESSORIES FOR SELF-SUPPORTING SYSTEMS

| GROUP | TYPE | DESCRIPTION | QUANT. | ARTICLE NUMBER | | | | UN. | PRICE / UNIT | | |
|--|---|--|--------|----------------|----------------|----------------|--------------------|-------------------|-------------------|------------------|---------|
| MT | MOUNTING ACCESSORIES | | | 0 | 9010 | 7016 ST | RAL | | 0 | STANDARD COLOURS | RAL * |
|  | RING | Stainless lock washer M10 for PXLX | pc | 72911 | | | | pc | € 0.15 | | |
| | K | Connector for rafter D1/D2 | 0.04m | 21558 | | | | pc | € 6.70 | | |
| | KD3 | Connector for rafter D3 | 0.04m | 43185 | | | | pc | € 30.01 | | |
|  | 411 | Outlet 3m + socket Ø 80mm | 3m | | 10523 | 43729 | | m | € 15.45 | | |
| | 413 | Elbow 67° with socket Ø 80mm | pc | | 10528 | 43732 | | pc | € 9.98 | | |
| | 414 | Elbow 87° with socket Ø 80mm | pc | | 10530 | 43733 | | pc | € 9.98 | | |
| | GVL | Concentric adapter Ø 80/75 grey | pc | 80814 | | | | pc | € 3.56 | | |
| | 412 | Bracket for outlet | pc | | 10526 | 43730 | | pc | € 4.33 | | |
| | 412S | Screw for bracket | pc | 10532 | | | | pc | € 0.54 | | |
| | GC | Water outlet + swivel Ø 80mm grey | pc | 13308 | | | | pc | € 12.55 | | |
| | GATZ | Core drill Ø 80mm | pc | 41354 | | | | pc | € 31.86 | | |
| | BOOR | Conical countersink Ø 16.5mm | pc | 51197 | | | | pc | € 46.10 | | |
| | BOOR | Conical countersink Ø 20.5mm | pc | 51819 | | | | pc | € 50.42 | | |
| | BUGS | Universal outlet | pc | 22387 | 22389 | 31384 | 22391 | pc | € 14.10 | € 22.37 | € 25.73 |
| | WUGS | Outlet gutter spout | pc | 22392 | | | | pc | € 14.76 | | |
| | GB | Sealing tape gutter connector | pc | 13309 | | | | pc | € 7.97 | | |
| | LOGO | Logo Climalux for end piece gutter | pc | 35791 | | | | pc | € 4.34 | | |
| | LOGO | Logo Climax for end piece gutter | pc | 29943 | | | | pc | € 4.34 | | |
| | KAL 8 | PVC buffer 8mm for single glazing | pc | 27578 | | | | pc | € 0.28 | | |
| | KAL 20 | Pvc buffer 20mm for double glazing | pc | 27331 | | | | pc | € 0.45 | | |
| | KAL 22 | PVC buffer 22mm for glazing in TRB profile | pc | 47663 | | | | pc | € 0.23 | | |
| | KAL 28 | PP buffer 28mm for glazing in WB profile | pc | 69951 | | | | pc | € 0.62 | | |
| | HILO25 | Galvanised screw for PVC 5.2 x 25mm for CLSB (set of 25 pcs) | 25 pcs | 24202 | | | | set (25) | € 6.00 | | |
| HILO40 | Galvanised screw for PVC 5.2 x 40mm for CLSB (set of 25 pcs) | 25 pcs | 24201 | | | | set (25) | € 6.00 | | | |
| HILO45 | Stainless steel screw for PVC 6 x 45mm for CLSB (set of 25 pcs) | 25 pcs | 82206 | | | | set (25) | € 11.00 | | | |
| ZSC | Stainless steel screw + butyl sealing TX 25 self drilling for TP - TPG - TPGL | pc | 23963 | | | | pc | € 1.17 | | | |
| ZSB/G | Stainless steel screw 5.5 x 32mm TX 25 self drilling | pc | 20911 | 18740 | 31382 | 21596 | pc | € 0.52 | € 0.67 | € 0.82 | |
| ZSB | Galvanised steel screw 5.5 x 25mm TX 25 | pc | 82416 | | | | pc | € 0.52 | | | |
| SCR | Stainless steel screw 5.5 x 25mm TX 25 (set of 2 or 8 pcs) for KGAS & GASXL | 2 st 8 st | | 81834 71975 | 81833 71974 | 81832 71904 | set (2) set (8) | € 4.12 € 10.30 | € 4.74 € 11.85 | | |

FINISHING

0: mill-finished aluminium or standard

RAL 9010 white / RAL 7016 ST anthracite structure: in stock (delivery time max. 3 weeks)

Other standard RAL colours: start up costs of € 200 net for each colour (delivery time max. 4 weeks)

* any other RAL colour: +15% and start up cost of € 200 net for each colour (delivery time max. 4 weeks)

| GROUP | TYPE | DESCRIPTION | QUANT. | ARTICLE NUMBER | | | | UN. | PRICE / UNIT | | |
|-------|----------------------|--|--------|----------------|-------|---------|-------|----------|--------------|------------------|--------|
| MT | MOUNTING ACCESSORIES | | | 0 | 9010 | 7016 ST | RAL | | 0 | STANDARD COLOURS | RAL * |
| | PS48 | Self drilling stainless Parker screw 4.8 x 25mm for stop | pc | 8431 | 22595 | 31383 | 22598 | pc | € 0.50 | € 0.67 | € 0.77 |
| | PST | Self tapping stainless screw 4.8 x 13 Torx | pc | 30767 | | | | pc | € 0.11 | | |
| | SCR | Stainless steel screw 4.8 x 16mm TX 25 for screens | 25 pcs | 71989 | | | | set (25) | € 8.00 | | |
| | NP | Self drilling screw Hilti HPS 8/10 | pc | 52679 | | | | pc | € 0.91 | | |
| | ZSR | Anchor plug HSA 8/75 | pc | 52640 | | | | pc | € 3.49 | | |
| | BITS | Torxbit for stainless screw | pc | 18744 | | | | pc | € 3.30 | | |

| GROUP | TYPE | DESCRIPTION | QUANT. | ARTICLE NUMBER | | | | UN. | PRICE / UNIT | | |
|-------|----------------------------------|------------------------|--------|----------------|-------|---------|-------|-----|--------------|------------------|---------|
| MT | MOUNTING ACCESSORIES DOUBLE ROOF | | | 0 | 9010 | 7016 ST | RAL | | 0 | STANDARD COLOURS | RAL * |
| | 8421 | Tube 16/1.5 | 6m | 17912 | 17934 | 31376 | 17937 | pc | € 31.32 | € 51.03 | € 58.68 |
| | 8422 | Threaded bar M10 | 3m | 17979 | | | | pc | € 15.07 | | |
| | 8423 | Central drawing | pc | 24327 | 24329 | 31377 | 24331 | pc | € 68.40 | € 78.69 | € 90.49 |
| | 8420 | Cover drawing | pc | 24332 | 24333 | 31378 | 24335 | pc | € 19.11 | € 21.95 | € 25.24 |
| | 8424 | End piece threaded bar | pc | 17992 | 18061 | 31379 | 18064 | pc | € 16.72 | € 19.26 | € 22.15 |
| | 8425 | Ridge fixing | pc | 17993 | 18065 | 31380 | 18068 | pc | € 31.05 | € 58.39 | € 67.15 |
| | 8426 | Eye bolt M10 | pc | 17980 | | | | pc | € 29.32 | | |
| | 8428 | Stainless Nut M10 | pc | 17995 | | | | pc | € 0.45 | | |
| | 8427 | Stainless bolt M10/30 | pc | 17994 | | | | pc | € 0.90 | | |
| | 8429 | Safety nut M10 | pc | 17996 | | | | pc | € 0.74 | | |

| GROUP | TYPE | DESCRIPTION | QUANT. | ARTICLE NUMBER | | | | UN. | PRICE / UNIT | | |
|-------|---------------------------------|--|--------|----------------|-------|---------|-------|-----|--------------|------------------|---------|
| MT | MOUNTING ACCESSORIES CLIMACROWN | | | 0 | 9010 | 7016 ST | RAL | | 0 | STANDARD COLOURS | RAL * |
| | BEUG | Bracket for GX - Climacrown | pc | 48040 | | | | pc | € 6.61 | | |
| | HAAK | Hook for GX - Climacrown | pc | 48041 | 48043 | 48044 | 48042 | pc | € 8.56 | € 17.47 | € 20.09 |
| | BOUT | Stainless steel screw M5 x 20 for hook | pc | 47595 | | | | pc | € 0.42 | | |
| | MOER | Stainless steel nut M5 | pc | 25705 | | | | pc | € 0.10 | | |
| | RING | Stainless steel ring M5 | pc | 25920 | | | | pc | € 0.20 | | |

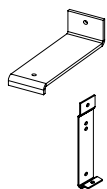

| GROUP | TYPE | DESCRIPTION | QUANT. | ARTICLE NUMBER | | | | UN. | PRICE / UNIT | | |
|-------|---------------|---|--------|----------------|-------|---------|----------------|-----|--------------|------------------|----------|
| | MISCELLANEOUS | | | 0 | 9010 | 7016 ST | RAL | | 0 | STANDARD COLOURS | RAL * |
| | LAK | Paint brush for repair | pc | | 24198 | 31385 | 24199 | pc | | € 12.80 | € 25.50 |
| | RAL | Colour change for RAL | pc | 21782 | | | 21782 | pc | | | € 200.00 |
| | RAL2 | Colour change for structured lacquer | pc | 22612 | | | 22612 | pc | | | € 200.00 |
| | SILI | Silicon 310ml for use with PMMA and PC Warranty 10 year Blank & RAL = transparent | pc | 15460 (transp) | 4736 | 30378 | 15460 (transp) | pc | € 11.38 | € 11.38 | € 11.38 |
| | SG20 | Silicon glue 310ml for glass connector GVB - GVT - L432 - L632 | pc | 109085 (black) | | | | pc | € 38.45 | | |



FINISHING

0: mill-finished aluminium or standard

RAL 9010 white / RAL 7016 ST anthracite structure: in stock (delivery time max. 3 weeks)

Other standard RAL colours: start up costs of € 200 net for each colour (delivery time max. 4 weeks)

* any other RAL colour: +15% and start up cost of € 200 net for each colour (delivery time max. 4 weeks)

ACCESSORIES FOR SELF-SUPPORTING SYSTEMS

| GROUP | TYPE | DESCRIPTION | QUANT. | ARTICLE NUMBER | | | UN. | PRICE / UNIT | | |
|---|--------------------|---|--------|----------------|----------|--|-----|-----------------|--|--|
| | LED STRIPES | | | | 0 | | | 0 | | |
|  | LED | LED roll for GDGL | 4.00m | 49555 | | | pc | € 131.40 | | |
| | | IP67 - 24V - 7W/m - 120 dots/m | 5.00m | 49556 | | | pc | € 164.10 | | |
| | | | 6.00m | 49557 | | | pc | € 197.00 | | |
| | | | 7.00m | 49558 | | | pc | € 229.81 | | |
| | LEDCO | PC LED cover (for CC150 / CC225) | 2.10m | 45737 | | | pc | € 18.10 | | |
| | | | 3.10m | 84999 | | | pc | € 25.00 | | |
| | TAPE | Tape for LED (roll 7m) | pc | 35885 | | | pc | € 7.92 | | |
| | TRAN | Transfo for LED 24V 30W IP66 (for LED 4m) | pc | 49559 | | | pc | € 59.00 | | |
| | | Transfo for LED 24V 60W IP66 (for LED 5/6/7m) | pc | 49560 | | | pc | € 101.32 | | |
| | AFST | Remote control 5 channels | pc | 39640 | | | pc | € 96.76 | | |
| | ONT | Receiver remote with dimmer | pc | 39641 | | | pc | € 185.03 | | |
| | KABES | Cable set for dimmer 2 x 0.5m | pc | 49561 | | | pc | € 11.74 | | |
| | KABE | Cable for LED 6m | pc | 31023 | | | pc | € 13.50 | | |

| GROUP | TYPE | DESCRIPTION | QUANT. | ARTICLE NUMBER | | | UN. | PRICE / UNIT | | |
|-------|------------------|---------------------------------------|--------|----------------|----------|--|-----|-----------------|--|--|
| | LED SPOTS | | | | 0 | | | 0 | | |
| | VTLED | Basic set for 6 LED spots - 2800K | set | 39629 | | | set | € 436.58 | | |
| | VTLED | Basic set for 12 LED spots - 2800K | set | 39630 | | | set | € 689.35 | | |
| | VTLED | Extension set for 3 LED spots - 2800K | set | 39628 | | | set | € 111.27 | | |
| | SPOT | LED spot Ø 35mm - 3W - 2800K | pc | 39617 | | | pc | € 37.00 | | |
| | VTLED | Basic set for 6 LED spots - 4000K | set | 113633 | | | set | € 436.58 | | |
| | VTLED | Basic set for 12 LED spots - 4000K | set | 113634 | | | set | € 689.35 | | |
| | VTLED | Extension set for 3 LED spots - 4000K | set | 113632 | | | set | € 111.27 | | |
| | SPOT | LED spot Ø 35mm - 3W - 4000K | pc | 113631 | | | st | € 37.00 | | |
| | AFST | Remote control 5 channels | pc | 39640 | | | pc | € 96.76 | | |
| | ONT | Receiver remote with dimmer | pc | 39641 | | | pc | € 185.03 | | |
| | TRAN30 | Transformer for LED spots 24V 30W | pc | 39652 | | | pc | € 120.92 | | |
| | TRAN60 | Transformer for LED spots 24V 60W | pc | 39653 | | | pc | € 195.93 | | |
| | BL3 | Distributor 3 sockets | pc | 39664 | | | pc | € 4.95 | | |
| | BL6 | Distributor 6 sockets | pc | 39665 | | | pc | € 5.91 | | |
| | KABEL5 | Cable for spots 5m | pc | 39676 | | | pc | € 5.81 | | |
| | KABEL7 | Cable for spots 7m | pc | 39677 | | | pc | € 7.26 | | |
| | KABEL9 | Cable for spots 9m | pc | 39678 | | | pc | € 8.70 | | |
| | JMP | Jumper bridge for distributor | pc | 39642 | | | pc | € 0.73 | | |









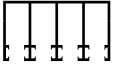
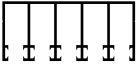

FINISHING

O: mill-finished aluminium or standard

RAL 9010 white / RAL 7016 ST anthracite structure: in stock (delivery time max. 3 weeks)







Other standard RAL colours: start up costs of € 200 net for each colour (delivery time max. 4 weeks)

* any other RAL colour: +15% and start up cost of € 200 net for each colour (delivery time max. 4 weeks)

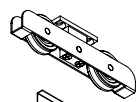
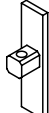
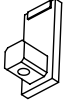
| GROUP | TYPE | DESCRIPTION | QUANT. | ARTICLE NUMBER | | | | UN. | PRICE / UNIT | | |
|---|--|---|--------|----------------|--------|---------|---------|-----|--------------|------------------|----------|
| CG | CLIMAGLIDE PROFILES (UNTREATED) | | MM | 0 | 9010 | 7016 ST | RAL | | 0 | STANDARD COLOURS | RAL * |
|  | VPRAILT3.Z | Upper rail for 3 or 6 glass sheets | 3040 | 94666 | 94668 | 94667 | 106122 | m | € 36.50 | € 41.98 | € 48.28 |
| | | | 4040 | 94669 | 94671 | 94670 | 106123 | m | € 36.50 | € 41.98 | € 48.28 |
| | | | 6040 | 94672 | 94674 | 94673 | 106124 | m | € 36.50 | € 41.98 | € 48.28 |
|  | VPRAILT4.Z | Upper rail for 4 or 8 glass sheets | 3040 | 94675 | 94677 | 94676 | 110046 | m | € 47.28 | € 54.37 | € 62.53 |
| | | | 4040 | 94678 | 94680 | 94679 | 110047 | m | € 47.28 | € 54.37 | € 62.53 |
| | | | 5040 | 94681 | 94683 | 94682 | 110048 | m | € 47.28 | € 54.37 | € 62.53 |
| | | | 7040 | 94684 | 94686 | 94685 | 110049 | m | € 47.28 | € 54.37 | € 62.53 |
|  | VPRAILT5.Z | Upper rail for 5 or 10 glass sheets | 5040 | 94687 | 94689 | 94688 | 110050 | m | € 57.19 | € 65.77 | € 75.64 |
| | | | 7040 | 94690 | 94692 | 94691 | 110051 | m | € 57.19 | € 65.77 | € 75.64 |
|  | VPRAILB3 | Lower rail for 3 or 6 glass sheets | 3040 | 48537 | | | | m | € 26.86 | | |
| | | | 4040 | 48538 | | | | m | € 26.86 | | |
| | | | 6040 | 48539 | | | | m | € 26.86 | | |
|  | VPRAILB4 | Lower rail for 4 or 8 glass sheets | 3040 | 80240 | | | | m | € 33.80 | | |
| | | | 4040 | 48540 | | | | m | € 33.88 | | |
| | | | 5040 | 48541 | | | | m | € 33.96 | | |
| | | | 7040 | 48542 | | | | m | € 34.04 | | |
|  | VPRAILB5 | Lower rail for 5 or 10 glass sheets | 5040 | 48543 | | | | m | € 43.22 | | |
| | | | 7040 | 48544 | | | | m | € 43.22 | | |
|  | VPCGL.P | Alu side profile for 8 and 10mm glass | 2600 | 112891 | 112903 | 112909 | 112897 | pc | € 37.06 | € 42.62 | € 49.01 |
| | | | 3100 | 112894 | 112906 | 112912 | 112900 | pc | € 50.37 | € 57.92 | € 66.61 |
|  | VPCGPL | Roller block profile for 8 and 10mm glass | 1240 | 113299 | 113302 | 113301 | 113300 | m | € 36.10 | € 56.45 | € 64.92 |
| | | | 3040 | 112854 | 112887 | 112855 | 112867 | m | € 36.10 | € 56.45 | € 64.92 |
| | | | 4040 | 112856 | 112888 | 112857 | 112868 | m | € 36.10 | € 56.45 | € 64.92 |
| | | | 5040 | 112858 | 112889 | 112859 | 112869 | m | € 36.10 | € 56.45 | € 64.92 |
| | | | 7110 | 112860 | 112890 | 112861 | 112870 | pc | € 36.10 | € 56.45 | € 64.92 |
|  | VPFUND060 | Alu foundation profile 60 x 40 x 3mm | 6000 | 79752 | 51930 | 51929 | 81501 | pc | € 115.64 | € 192.72 | € 221.63 |
|  | VPFUND080 | Alu foundation profile 80 x 40 x 3mm | 6000 | 79753 | 51932 | 51931 | 81502 | pc | € 144.84 | € 224.26 | € 257.90 |
|  | VPFUND100 | Alu foundation profile 100 x 40 x 4mm | 6000 | 79754 | 51934 | 51933 | 81503 | pc | € 176.37 | € 256.96 | € 295.50 |
| CG | CLIMAGLIDE BRUSH FOR TOP AND SIDE PROFILES | | MM | 0 | | | | | 0 | | |
|  | 0.STRIP02 | Brush for top and side profile 8mm | 6.7x7 | 82030 | | | | m | € 1.60 | | |
| | | | 6.7x5 | 104204 | | | | m | € 1.60 | | |
| CG | CLIMAGLIDE ACCESSORIES SIDE PROFILES | | MM | 0 | | | | | 0 | | |
| | VTCGSH | Sliding handle anodised (without screws) | | 80332 | | | | pc | € 30.79 | | |
| | VTCGSH-A | Sliding latch (black) | 1190 | 112838 | | | | pc | € 60.00 | | |
| | | | 976 | 112844 | | | | pc | € 60.00 | | |
| | | | 876 | 112843 | | | | pc | € 60.00 | | |
| | | | 676 | 112842 | | | | pc | € 60.00 | | |
| | | | 576 | 112841 | | | | pc | € 60.00 | | |
| | | | 376 | 112840 | | | | pc | € 60.00 | | |
| | 276 | 112839 | | | | pc | € 60.00 | | | | |
| | VTCGSH-B | Spring for sliding handle | | 80337 | | | | pc | € 4.00 | | |
| | VTCGCAL | Installation gauge for side profile (set) | | 80329 | | | | set | € 8.00 | | |

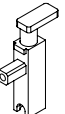
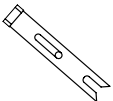
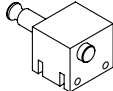

FINISHING | 2 standard RAL colours: white 9010 and anthracite 7016 ST (delivery time max. 3 weeks) / no surcharge
 * Other RAL colours of choice: see p. 8 & 9 (start up costs of € 200) – delivery time max. 4 weeks

ACCESSORIES FOR SELF-SUPPORTING SYSTEMS

| GROUP | TYPE | DESCRIPTION | QUANT. | ARTICLE NUMBER | | | | UN. | PRICE / UNIT | | |
|-----------|---|--|---|----------------|------------------|------------------|------------------|------------------|--------------|-------------------------|------------------------------------|
| | | | | 0 | 9010 | 7016 ST | RAL | | 0 | STANDARD COLOURS | RAL * |
| CG | CLIMAGLIDE ACCESSORIES ROLLER BLOCK PROFILE | | MM | 0 | 9010 | 7016 ST | RAL | | 0 | STANDARD COLOURS | RAL * |
| |  | VRCG08 | Glass seal for 8m glass | 113388 | | | | | m | € 3.50 | |
| | | VRCG10 | Glass seal for 10mm glass | 48545 | | | | | m | € 3.50 | |
| |  | VTLOOP01 | Roller block (without fixation screws) | 48569 | | | | | pc | € 29.20 | |
| |  | VTCGPLS | Alu end piece for roller block profile 10mm | 79720 | 79732 | 79731 | 79730 | | pc | € 15.30 | € 17.60 € 20.23 |
| |  | VTCGPLSS | Alu end piece for roller block profile 10mm - short version | 80229 | 80232 | 80231 | 80230 | | pc | € 15.30 | € 17.60 € 20.23 |
| | | VTCGCL | End piece roller block profile for sliding latch | 80233 | | | | | pc | € 14.84 | |
| | | VTLOOP04B | Counterplate carrier inside | 80667 | | | | | pc | € 5.25 | |
| | | VTLOOP04C | Plate carrier outside | 80668 | | | | | pc | € 5.25 | |
| | | VTLOOP04E | Rectangular rubber bumper type 2 | 118897 | | | | | pc | € 5.25 | |
| |  | VTLOOP02B | POM rail for carrier system | 52924 | | | | | pc | € 12.94 | |
| |  | VTCGPLL | Lock (complete) | 79721 | 79735 | 79734 | 79733 | | pc | € 57.90 | € 68.42 € 74.41 |
| | | VTCGPLLB | Body for lock | 81542 | 81548 | 81549 | 81547 | | pc | € 29.39 | € 39.91 € 45.90 |
| |  | VTCGPLLG | Pin for lock | 81543 | | | | | pc | € 28.31 | |
| |  | VTCGBL L | Latch block left, seen from the inside (anodised) | 48564 | | | | | pc | € 67.74 | |
| | VTCGBL R | Latch block right, seen from the inside (anodised) | 112877 | | | | | pc | € 67.74 | | |
| CG | CLIMAGLIDE ACCESSORIES GLASS | | MM | 0 | 9010 | 7016 ST | RAL | | 0 | STANDARD COLOURS | RAL * |
| | | VDICHT01-08 | Flexible middle panel seal for L + R systems made of PVC 8mm | 2500 | 81352 | | | | pc | € 39.72 | |
| |  | VDICHT01-10 | Flexible middle panel seal for L + R systems made of PVC 10mm | 2500 | 80942 | | | | pc | € 39.72 | |
| |  | VTOOCHT04 | Alu sealing profile for 8 and 10mm without brush | 2500 3000 | 112931 112932 | 112937 112938 | 112935 112936 | 112933 112934 | pc pc | € 37.04 € 52.40 | € 41.72 € 47.98 € 56.41 € 64.87 |
| |  | O.STRIP01 | Sealing brush for alu profile | 4.8 x 13 | 80883 | | | | m | € 2.00 | |
| |  | VTOOCHT05_PVC08 | PVC sealing brush for 8mm without brush | 2378 | 99642 | | | | pc | € 13.78 | |
| | | VTOOCHT05_PVC08 | PVC sealing brush for 8mm without brush | 2878 | 99643 | | | | pc | € 16.85 | |

FINISHING

2 standard RAL colours: white 9010 and anthracite 7016 ST (delivery time max. 3 weeks) / no surcharge
 * Other RAL colours of choice: see p. 8 & 9 (start up costs of € 200) – delivery time max. 4 weeks





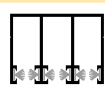
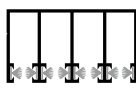
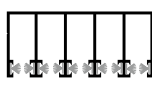
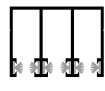
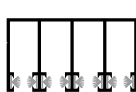
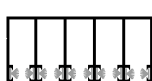



| GROUP | TYPE | DESCRIPTION | QUANT. | ARTICLE NUMBER | | | UN. | PRICE / UNIT | | |
|---|------------------------------|---|---------|----------------|------|---------|-----|--------------|------------------|-------|
| CG | CLIMAGLIDE ACCESSORIES GLASS | | MM | 0 | 9010 | 7016 ST | RAL | 0 | STANDARD COLOURS | RAL * |
|  | VTTOCHT06_PVC10 | PVC sealing brush for 10mm without brush | 2378 | 99644 | | | | pc | € 14.04 | |
| | VTTOCHT06_PVC10 | PVC sealing brush for 10mm without brush | 2878 | 99645 | | | | pc | € 17.16 | |
|  | 0.STRIPO2 | Sealing brush for PVC profile | 6.7 x 9 | 108049 | | | | m | € 1.80 | |
| | VTGREEP02-A | Screw-on handle (8mm) made of anodised aluminium D68/60 | | 43661 | | | | pc | € 54.90 | |
|  | VTGREEP02-RVS | Screw-on handle (8mm) made of stainless steel D68/60 | | 49553 | | | | pc | € 54.90 | |
| | VTGREEP03 | Set anodised self-adhesive handle (8 and 10mm) | | 80877 | | | | pc | € 70.08 | |

| CG | CLIMAGLIDE SCREWS | | MM | 0 | | | | 0 | | |
|----|-------------------|--|-------|--------|--|--|--|----|--------|--|
| | VTSCR.013 | Screw for end piece roller block and short end piece together (1 pc) | M5x20 | 80936 | | | | pc | € 0.50 | |
| | VTSCR.013 | Screw for carrier (2 pcs/carrier) | M5x8 | 80339 | | | | pc | € 0.30 | |
| | VTSCR.013 | Screw for sliding handle (3 pcs) | M4x8 | 80338 | | | | pc | € 0.20 | |
| | VTSCR.014 | Screw for pin latch block or lock (1/latch) | M5x12 | 80938 | | | | pc | € 0.35 | |
| | VTSCR.014 | Screw for fixation latch block on lower rail (2/latch block) | M5x5 | 80939 | | | | pc | € 0.30 | |
| | VTSCR.014 | Screw for end piece and lock (1/end piece or lock) | M5x8 | 80940 | | | | pc | € 0.30 | |
| | VTSCR.015 | Ball screw for lock (1/lock) | M5x12 | 80941 | | | | pc | € 6.00 | |
| | VTSCR.021 | Self-drilling screw for roller block (2 pcs) | M4x13 | 114551 | | | | pc | € 0.20 | |

| CG | CLIMAGLIDE COMPILED AND TREATED PROFILES | | MM | 0 | 9010 | 7016 ST | RAL | 0 | STANDARD COLOURS | RAL * |
|---|--|---|------|---|--------|---------|-----|---|------------------|-------|
|  | VPRAILT3.08 | Upper rail for 3 or 6 glass sheets for 8mm with brush | 3000 | | 113306 | 113305 | | m | € 61.90 | |
| | | | 4000 | | 113310 | 113309 | | m | € 61.90 | |
| | | | 6000 | | 113314 | 113313 | | m | € 61.90 | |
|  | VPRAILT4.08 | Upper rail for 4 or 8 glass sheets for 8mm with brush | 3000 | | 113318 | 113317 | | m | € 80.60 | |
| | | | 4000 | | 113322 | 113321 | | m | € 80.60 | |
| | | | 5000 | | 113326 | 113325 | | m | € 80.60 | |
| | | | 7000 | | 113330 | 113329 | | m | € 80.60 | |
|  | VPRAILT5.08 | Upper rail for 5 or 10 glass sheets for 8mm with brush | 5000 | | 113334 | 113333 | | m | € 98.12 | |
| | | | 7000 | | 113338 | 113337 | | m | € 98.12 | |
|  | VPRAILT3.10 | Upper rail for 3 or 6 glass sheets for 10mm with brush | 3000 | | 80244 | 80243 | | m | € 61.90 | |
| | | | 4000 | | 80248 | 80247 | | m | € 61.90 | |
| | | | 6000 | | 80252 | 80251 | | m | € 61.90 | |
|  | VPRAILT4.10 | Upper rail for 4 or 8 glass sheets for 10mm with brush | 3000 | | 80256 | 80255 | | m | € 80.60 | |
| | | | 4000 | | 80260 | 80259 | | m | € 80.60 | |
| | | | 5000 | | 80264 | 80263 | | m | € 80.60 | |
| | | | 7000 | | 80268 | 80267 | | m | € 80.60 | |
|  | VPRAILT5.10 | Upper rail for 5 or 10 glass sheets for 10mm with brush | 5000 | | 80272 | 80271 | | m | € 98.12 | |
| | | | 7000 | | 80276 | 80275 | | m | € 98.12 | |

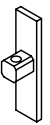
FINISHING | 2 standard RAL colours: white 9010 and anthracite 7016 ST (delivery time max. 3 weeks) / no surcharge
 * Other RAL colours of choice: see p. 8 & 9 (start up costs of € 200) – delivery time max. 4 weeks

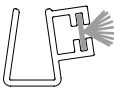
ACCESSORIES FOR SELF-SUPPORTING SYSTEMS

| GROUP | TYPE | DESCRIPTION | QUANT. | ARTICLE NUMBER | | | UN. | PRICE / UNIT | | |
|---|--|---|--------|----------------|--------|---------|-----|--------------|------------------|-------|
| CG | CLIMAGLIDE COMPILED AND TREATED PROFILES | | MM | 0 | 9010 | 7016 ST | RAL | 0 | STANDARD COLOURS | RAL * |
|  | VPCGL.08B | Alu side profile with brush for 8mm | 2451 | | 113374 | 113373 | | pc | € 60.74 | |
| | | | 2951 | | 113378 | 113377 | | pc | € 81.02 | |
| | VPCGL.08 SH-R | Alu side profile for 8mm right with brush and sliding latch for park side left, seen from the inside | 2451 | | 113366 | 113365 | | pc | € 210.89 | |
| | | | 2951 | | 113370 | 113369 | | pc | € 220.63 | |
|  | VPCGL.08 SH-L | Alu side profile for 8mm left with brush and sliding latch for park side right, seen from the inside | 2451 | | 113358 | 113357 | | pc | € 210.89 | |
| | | | 2951 | | 113362 | 113361 | | pc | € 220.63 | |
| | VPCGL.10B | Alu side profile with brush for 10mm | 2451 | | 113382 | 113381 | | pc | € 60.74 | |
| | | | 2951 | | 113386 | 113385 | | pc | € 81.02 | |
|  | VPCGL.10 SH-R | Alu side profile for 10mm right with brush and sliding latch for park side left, seen from the inside | 2451 | | 113352 | 113348 | | pc | € 210.89 | |
| | | | 2951 | | 113354 | 113350 | | pc | € 220.63 | |
| | VPCGL.10 SH-L | Alu side profile for 10mm left with brush and sliding latch for park side right, seen from the inside | 2451 | | 113351 | 113347 | | pc | € 210.89 | |
| | | | 2951 | | 113353 | 113349 | | pc | € 220.63 | |
|  | VTLOOP02.08 | Pre-mounted roller block for 8mm - profile incl. + 2 roller blocks + glass seal - end pieces excl. | 850 | | 51993 | 51992 | | pc | € 141.33 | |
| | | | 1000 | | 51784 | 51783 | | pc | € 147.17 | |
| | | | 1200 | | 51788 | 51787 | | pc | € 160.02 | |
|  | VTLOOP02.10 | Pre-mounted roller block for 10mm - profile incl. + 2 roller blocks + glass seal - end pieces excl. | 850 | | 113279 | 113278 | | pc | € 141.33 | |
| | | | 1000 | | 113283 | 113282 | | pc | € 147.17 | |
| | | | 1200 | | 113287 | 113286 | | pc | € 160.02 | |
|  | VTGGLSSCR | Alu end piece with screw for roller block profile for 8 or 10mm | | | 113231 | 113230 | | pc | € 21.48 | |
|  | VTTOCHT01 | Alu sealing profile laquered with brush for 8 and 10mm | 2500 | | 51924 | 51925 | | pc | € 46.72 | |
| | VTTOCHT03 | Alu sealing profile laquered with brush for 8 and 10mm | 3000 | | 81560 | 81561 | | pc | € 56.06 | |
|  | VTTOCHT07_PVC08 | PVC profile transparent for 8mm with sealing brush | 2378 | 108095 | | | | pc | € 18.28 | |
| | | | 2878 | 108096 | | | | pc | € 22.25 | |
|  | VTTOCHT07_PVC10 | PVC profile transparent for 10mm with sealing brush | 2378 | 108097 | | | | pc | € 18.54 | |
| | | | 2878 | 108098 | | | | pc | € 22.56 | |

FINISHING

2 standard RAL colours: white 9010 and anthracite 7016 ST (delivery time max. 3 weeks) / no surcharge
 * Other RAL colours of choice: see p. 8 & 9 (start up costs of € 200) – delivery time max. 4 weeks

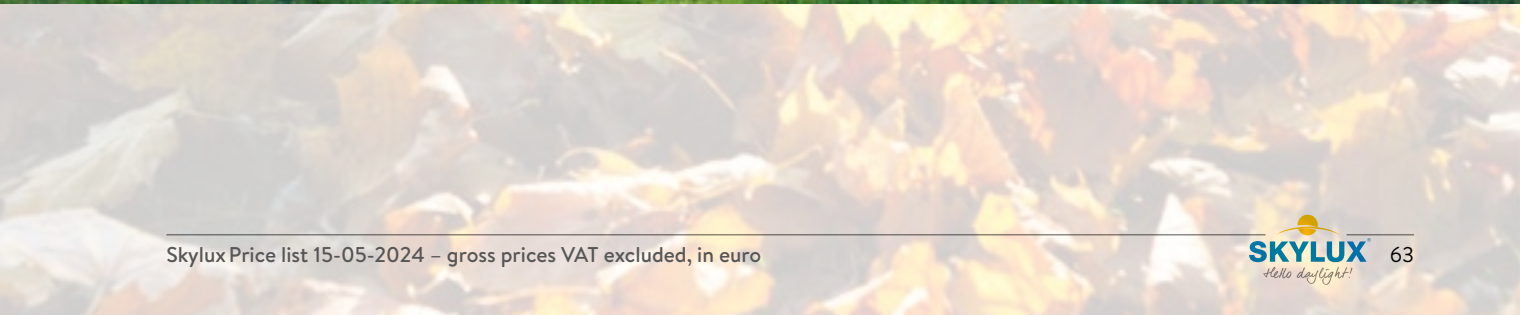

ACCESSORIES FOR SELF-SUPPORTING PROFILE SYSTEMS

TRIANGLE

The Skylux triangle profiles allow you to build a triangle- or rectangular-shaped frame in which glass or plastic can be installed. The aluminium profiles are maintenance-friendly, coated in accordance with the Qualicoat standard and available in all RAL colours and structured coating.

Profile 42mm – made to fit the roof

- Triangle formed by 2 types of non-thermal aluminium profiles: a base profile and a clip profile.
- The dimensions depend on the veranda.
- A supporting cross-beam (110/72) is necessary.
- If requested, Skylux can cut the top inclined profiles to guarantee an easy installation.
- Skylux provides a vertical U-profile to seal to opening and an H-profile for the vertical partition.
- Suitable for 10mm glass or double-sided UV-resistant 16mm plastic sheets.
- The profiles are delivered to size with all necessary accessories: screws, plugs and rubbers.

- gross price per triangle with an 8° pitch
- cross-beam P72 (110/72) included
- standard colours: 9010 white and 7016 ST anthracite
- trend colours: black 9005 ST, white aluminium 9006 ST, grey aluminium 9007 ST, 9009 ST, 9010 ST, cream white 9001, purple red RAL 3004 ST, RAL 7039 ST & RAL 8014 ST: standard price + € 200 surcharge for colour change
- other RAL colours: see p. 8 & 9 (+15% + fixed surcharge : € 200 net) – delivery time: max. 4 weeks

| Depth | # partitions | Profile for glass 10mm | Profile for sheets 16mm | Surcharge sheet 16mm 3W 2UV |
|-------|--------------|------------------------|-------------------------|-----------------------------|
| 2359 | 3 | € 513.55 | € 524.75 | € 204.04 |
| 2859 | 3 | € 569.24 | € 578.71 | € 204.04 |
| 3359 | 4 | € 755.82 | € 762.94 | € 204.04 |
| 3859 | 4 | € 770.90 | € 772.57 | € 204.04 |
| 4359 | 5 | € 783.95 | € 783.27 | € 204.04 |
| 4859 | 5 | € 836.39 | € 830.26 | € 204.04 |



WINDBREAK

- Protects against wind, sunlight, rain and creates privacy
- Combines perfectly with the Skylux triangle profiles
- Comes in 10mm glass or 16mm plastic sheets (double-sided UV-resistant)
- The number of panels can be configured by the customer
- Vertical H-profiles for partitions

The Skylux windbreak is installed below the triangle (p. 64) and is made of non-thermal aluminium frames.

The frames are provided with 10mm glass or 16mm plastic sheets (double-sided UV-resistant) and separated by aluminium H-profiles.

A useful solution to shield yourself from wind, sunlight, rain and to add privacy.

The windbreak is easy to configure. We deliver the frames with some margin on the dimensions to allow sufficient flexibility during installation.

| Depth | # partitions | Profile for glass 10mm | Profile for sheets 16mm | Surcharge sheet 16mm 3W 2UV |
|-------|--------------|------------------------|-------------------------|-----------------------------|
| 2359 | 3 | € 503.49 | € 476.90 | € 612.12 |
| 2859 | 3 | € 509.15 | € 480.83 | € 612.12 |
| 3359 | 4 | € 648.31 | € 599.04 | € 816.16 |
| 3859 | 4 | € 664.22 | € 613.22 | € 816.16 |
| 4359 | 5 | € 737.92 | € 665.97 | € 1020.20 |
| 4859 | 5 | € 743.58 | € 669.90 | € 1020.20 |

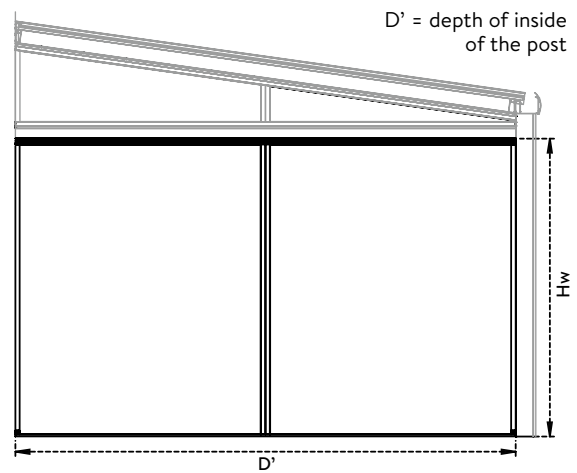

CLIMAGLIDE

Climaglide is a custom-made profile system for glass sliding elements. This system, which is delivered together with your veranda roof, provides protection from wind and rain and therefore represents a significant added value. The profiles' elegant, contemporary look contributes to increased aesthetics. The aluminium profiles require minimal maintenance, are coated in accordance with the Qualicoat standard and are available in all RAL colours and structured coatings.

Combined with 8mm or 10mm tempered glass (not provided by Skylux), Climaglide ensures a tough and safe system. These sliding glass elements are made for single glazing. It can be locked from the inside and provides protection against wind and rain. You can slide the elements separately to 1 or 2 sides (depending on which version you choose) to create a large opening. Or you can choose a carrier system which carries the glass panels to the direction you slide to (only available for 10mm). Elements that slide open to 2 sides are provided with a middle panel seal.

Climaglide can be installed in patio roofs without thermal break like Climax Panorama, Climalux and Climalux Horizon.

Climaglide is available in three versions:

- 8mm Basic: 8mm tempered glass (not provided by Skylux) with pre-mounted roller blocks for glass elements that can slide separately – cannot be locked – not pre-drilled.
- 8mm lockable: 8mm tempered glass (not provided by Skylux) with pre-mounted roller blocks for glass elements that can slide separately – can be locked. The bottom rail (CGB) with 3, 4 or 5 tracks is completely pre-drilled. Available accessories: - screw-on handles D65/50 made of anodised aluminium – set of 2 self-adhesive anodised aluminium handles with cleaning cloth – glue to attach the draught strips and brush seals in the same ordered RAL colour
- 10mm lockable: 10mm tempered glass (not provided by Skylux) with pre-mounted roller blocks for carrier system and a latch on one side. The bottom rail (CGB) with 3, 4 or 5 tracks is completely pre-drilled.

Available accessories: brush seals in the same ordered RAL colour

| Climaglide 8mm Basic (no wall profile, no latch block) | | | | | | |
|---|-------|-------|--------|--------|--------|--|
| Max. height 2350mm | | | | | | |
| Width in mm | | | | | | |
| System | 2000 | 2400 | 2800 | 3200 | 3600 | |
| 3 tracks 2 glass elements | € 844 | € 875 | | | | |
| 3 tracks 3 glass elements | € 844 | € 875 | € 878 | € 923 | | |
| 3 tracks 6 glass elements | | | | € 1074 | € 1119 | |
| 4 tracks 4 glass elements * | € 911 | € 993 | € 995 | € 1008 | € 1011 | |
| 4 tracks 8 glass elements | | | | | | |
| 5 tracks 5 glass elements | | | € 1129 | € 1145 | € 1146 | |
| 5 tracks 10 glass elements | | | | | | |

| Climaglide 8mm with separate elements | | | | | | |
|--|--------|--------|--------|--------|--------|--|
| Max. height 2350mm | | | | | | |
| Width in mm | | | | | | |
| System | 2000 | 2400 | 2800 | 3200 | 3600 | |
| 3 tracks 2 glass elements | € 953 | € 985 | | | | |
| 3 tracks 3 glass elements | € 954 | € 988 | € 988 | € 1035 | | |
| 3 tracks 6 glass elements | | | | € 1334 | € 1366 | |
| 4 tracks 4 glass elements * | € 1106 | € 1190 | € 1190 | € 1206 | € 1208 | |
| 4 tracks 8 glass elements | | | | | | |
| 5 tracks 5 glass elements | | | € 1327 | € 1342 | € 1345 | |
| 5 tracks 10 glass elements | | | | | | |

| Climaglide 10mm with carrier system | | | | | | |
|--|--------|--------|--------|--------|--------|--|
| Standard height 2500mm ** | | | | | | |
| Width in mm | | | | | | |
| System | 2000 | 2400 | 2800 | 3200 | 3600 | |
| 3 tracks 2 glass elements | € 1096 | € 1123 | | | | |
| 3 tracks 3 glass elements | € 1153 | € 1182 | € 1186 | € 1226 | | |
| 3 tracks 6 glass elements | | | | | € 1446 | |
| 4 tracks 4 glass elements * | € 1258 | € 1334 | € 1337 | € 1352 | € 1354 | |
| 4 tracks 8 glass elements | | | | | | |
| 5 tracks 5 glass elements | | | € 1573 | € 1589 | € 1590 | |
| 5 tracks 10 glass elements | | | | | | |

* for 3 tracks - 4 glass elements as L+R system: price 4 tracks + € 30

** surcharge max. height for double system (L + R): 2620mm and for single system (L or R): 3000mm: + € 71



| Width in mm | | | | | | | |
|-------------|--------|--------|--------|--------|--------|--------|--------|
| 4000 | 4400 | 4800 | 5200 | 5600 | 6000 | 6400 | 6800 |
| € 1131 | € 1196 | € 1211 | € 1214 | € 1215 | € 1229 | | |
| € 1028 | € 1074 | € 1079 | | | | | |
| | | € 1314 | € 1398 | € 1411 | € 1426 | € 1429 | € 1432 |
| € 1165 | € 1225 | € 1231 | € 1354 | € 1356 | | | |
| | | | € 1622 | € 1624 | € 1638 | € 1642 | € 1645 |

| Width in mm | | | | | | | |
|-------------|--------|--------|--------|--------|--------|--------|--------|
| 4000 | 4400 | 4800 | 5200 | 5600 | 6000 | 6400 | 6800 |
| € 1380 | € 1446 | € 1458 | € 1459 | € 1462 | € 1475 | | |
| € 1226 | € 1273 | € 1278 | | | | | |
| | | € 1659 | € 1754 | € 1758 | € 1773 | € 1776 | € 1778 |
| € 1363 | € 1424 | € 1450 | € 1553 | € 1555 | | | |
| | | | € 2027 | € 2030 | € 2042 | € 2051 | € 2055 |

| Width in mm | | | | | | | |
|-------------|--------|--------|--------|--------|--------|--------|--------|
| 4000 | 4400 | 4800 | 5200 | 5600 | 6000 | 6400 | 6800 |
| € 1459 | € 1518 | € 1532 | € 1534 | € 1538 | € 1550 | | |
| € 1370 | € 1388 | € 1418 | | | | | |
| | | € 1765 | € 1866 | € 1868 | € 1881 | € 1883 | € 1886 |
| € 1610 | € 1668 | € 1673 | € 1796 | € 1798 | | | |
| | | | € 2154 | € 2158 | € 2174 | € 2175 | € 2181 |

The above mentioned prices are valid for standard colours RAL9010 and 7016 ST. For other RAL colours, there is a surcharge of € 200 for each order.

VERTICAL SUNBLIND

1. General

Enjoy flawless fitted blinds with aluminium frames that perfectly match the colour of your roof. Skylux's blinds are fully compatible with the Climax, Climalux, Climalux Horizon, Climax Panorama and Climacrown canopies. The ZIP system ensures excellent fit, providing superior protection against insects and the wind. Blinds can be fitted to the front or sides of the canopy.

- Modern design
- Screen and actuator are easy to install
- Bottom slat integrates into the casing
- Screen canvas is always taut
- Side covers have no visible screws

2. Fabric options

All fabrics are suitable for both the Axiom and the Element range.

Copaco Serge 600

This screen canvas is woven with high-quality PVC coated glass fibre that allows for a light transmission of 5 %. There are more than 50 standard screen canvasses.

Serge Ferrari Soltis 92 & 88

Micro-perforated polyester canvas with a light transmission of 3 % (Soltis 92) and 8 % (Soltis 88).



3. Surcharge for Cristal window: € 49.88/m²

The following dimensions must be specified when ordering:

- window type
- h1: height from bottom bar to window
- bv: window width (only for type 2)

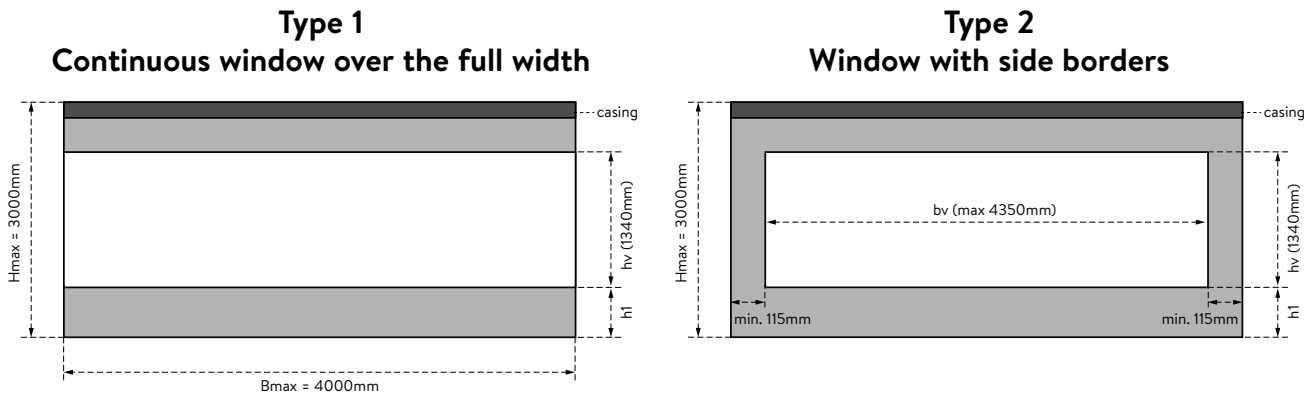

4. Adapter set

Adapter profile set for casing:

- Screens up to width 4m: € 129/piece
- Screens up to width 5m: € 147/piece
- Screens up to width 6m: € 165/piece

5. Axiom range

The Axiom range offers a timeless design thanks to the practically shaped casings and the bottom slat that retracts completely into the casing. Screens of up to 7 metres wide are possible. Even with maximum dimensions, the casing remains perfectly straight and the canvas is nicely taut.

- Casing 100mm 90° (straight casing) for screens up to 4m wide.
- Casing 130mm 90° (straight casing) for screens up to 6m wide.
- Casing 130 XL 90° (straight casing) for screens between 6 & 7m wide.

Actuator options

Screens within the Axiom range are equipped with the latest Somfy io actuators.

Somfy Sunilus io actuator

Wireless io actuator with feedback to the remote. Both top and bottom endpoints need to be programmed during installation. The actuator needs to be wired to the power grid.

See tables [A](#) and [B](#).

Somfy Maestria io actuator

Wireless io actuator with feedback to the remote. Only the bottom endpoint needs to be programmed during installation. The actuator is equipped with obstacle detection, compensation for fabric stretching and back release so the fabric is always suspended in the most optimal way. The actuator needs to be wired to the power grid.

See tables [C](#) and [D](#).

Somfy RS100 solar actuator

Wireless io actuator with feedback to the remote. The RS100 solar io actuator is a silent solution that does not require a connection to the power grid. In other words, it is a stand-alone solution and compatible with the TaHoma control cabinet.

See tables [E](#) and [F](#).

ACCESSORIES FOR SELF-SUPPORTING SYSTEMS

A

Gross prices AXIOM 100 non solar

| Width (mm) → ↓ Height (mm) | 1000 | 1100 | 1200 | 1300 | 1400 | 1500 | 1600 | 1700 | 1800 | 1900 | 2000 | 2100 | 2200 | 2300 | 2400 |
|-------------------------------|--------|--------|--------|--------|--------|--------|--------|--------|--------|--------|--------|--------|--------|--------|--------|
| 2000 | € 838 | € 865 | € 889 | € 918 | € 944 | € 969 | € 995 | € 1023 | € 1049 | € 1073 | € 1100 | € 1128 | € 1153 | € 1180 | € 1205 |
| 2100 | € 856 | € 883 | € 908 | € 936 | € 961 | € 991 | € 1014 | € 1044 | € 1069 | € 1098 | € 1123 | € 1152 | € 1176 | € 1205 | € 1231 |
| 2200 | € 872 | € 900 | € 929 | € 955 | € 981 | € 1010 | € 1036 | € 1063 | € 1091 | € 1120 | € 1147 | € 1175 | € 1202 | € 1228 | € 1256 |
| 2300 | € 889 | € 918 | € 946 | € 974 | € 1002 | € 1032 | € 1059 | € 1085 | € 1114 | € 1140 | € 1170 | € 1198 | € 1225 | € 1254 | € 1283 |
| 2400 | € 908 | € 936 | € 965 | € 993 | € 1020 | € 1051 | € 1080 | € 1108 | € 1136 | € 1165 | € 1192 | € 1220 | € 1249 | € 1279 | € 1308 |
| 2500 | € 926 | € 955 | € 981 | € 1013 | € 1041 | € 1069 | € 1100 | € 1128 | € 1156 | € 1187 | € 1215 | € 1247 | € 1275 | € 1303 | € 1335 |
| 2600 | € 941 | € 973 | € 1000 | € 1032 | € 1062 | € 1090 | € 1120 | € 1149 | € 1180 | € 1211 | € 1239 | € 1270 | € 1296 | € 1327 | € 1355 |
| 2700 | € 959 | € 991 | € 1020 | € 1049 | € 1080 | € 1111 | € 1140 | € 1172 | € 1201 | € 1231 | € 1261 | € 1292 | € 1322 | € 1352 | € 1410 |
| 2800 | € 977 | € 1008 | € 1038 | € 1069 | € 1100 | € 1130 | € 1162 | € 1192 | € 1222 | € 1254 | € 1284 | € 1316 | € 1345 | € 1406 | € 1437 |
| 2900 | € 995 | € 1026 | € 1056 | € 1087 | € 1120 | € 1152 | € 1182 | € 1213 | € 1247 | € 1277 | € 1308 | € 1339 | € 1400 | € 1432 | € 1465 |
| 3000 | € 1010 | € 1044 | € 1073 | € 1108 | € 1138 | € 1172 | € 1202 | € 1238 | € 1267 | € 1296 | € 1332 | € 1390 | € 1423 | € 1455 | € 1488 |

B

Gross prices AXIOM 130 non solar

| Width (mm) → ↓ Height (mm) | 1000 | 1100 | 1200 | 1300 | 1400 | 1500 | 1600 | 1700 | 1800 | 1900 | 2000 | 2100 | 2200 | 2300 | 2400 |
|-------------------------------|--------|--------|--------|--------|--------|--------|--------|--------|--------|--------|--------|--------|--------|--------|--------|
| 2000 | € 952 | € 981 | € 1010 | € 1041 | € 1074 | € 1100 | € 1130 | € 1165 | € 1194 | € 1223 | € 1252 | € 1285 | € 1342 | € 1374 | € 1402 |
| 2100 | € 974 | € 1002 | € 1031 | € 1064 | € 1095 | € 1126 | € 1156 | € 1188 | € 1214 | € 1250 | € 1279 | € 1310 | € 1372 | € 1402 | € 1432 |
| 2200 | € 992 | € 1022 | € 1055 | € 1084 | € 1116 | € 1151 | € 1178 | € 1211 | € 1246 | € 1276 | € 1305 | € 1338 | € 1399 | € 1430 | € 1463 |
| 2300 | € 1010 | € 1041 | € 1077 | € 1109 | € 1139 | € 1174 | € 1205 | € 1234 | € 1269 | € 1299 | € 1334 | € 1366 | € 1425 | € 1460 | € 1493 |
| 2400 | € 1031 | € 1064 | € 1097 | € 1129 | € 1162 | € 1196 | € 1229 | € 1261 | € 1293 | € 1329 | € 1359 | € 1418 | € 1454 | € 1487 | € 1518 |
| 2500 | € 1051 | € 1084 | € 1116 | € 1153 | € 1185 | € 1214 | € 1252 | € 1285 | € 1315 | € 1352 | € 1384 | € 1451 | € 1482 | € 1514 | € 1552 |
| 2600 | € 1071 | € 1106 | € 1136 | € 1174 | € 1209 | € 1240 | € 1276 | € 1308 | € 1345 | € 1379 | € 1409 | € 1477 | € 1507 | € 1542 | € 1577 |
| 2700 | € 1090 | € 1126 | € 1162 | € 1194 | € 1229 | € 1266 | € 1299 | € 1335 | € 1369 | € 1403 | € 1438 | € 1502 | € 1539 | € 1571 | € 1606 |
| 2800 | € 1110 | € 1146 | € 1181 | € 1214 | € 1252 | € 1288 | € 1323 | € 1359 | € 1393 | € 1431 | € 1466 | € 1530 | € 1564 | € 1599 | € 1637 |
| 2900 | € 1130 | € 1168 | € 1201 | € 1237 | € 1276 | € 1310 | € 1348 | € 1383 | € 1423 | € 1455 | € 1489 | € 1555 | € 1591 | € 1633 | € 1666 |
| 3000 | € 1151 | € 1188 | € 1223 | € 1261 | € 1296 | € 1335 | € 1370 | € 1408 | € 1445 | € 1478 | € 1520 | € 1581 | € 1620 | € 1656 | € 1693 |
| Width (mm) → ↓ Height (mm) | 4100 | 4200 | 4300 | 4400 | 4500 | 4600 | 4700 | 4800 | 4900 | 5000 | 5100 | 5200 | 5300 | 5400 | 5500 |
| 2000 | € 1982 | € 1994 | € 2005 | € 2036 | € 2068 | € 2098 | € 2127 | € 2160 | € 2190 | € 2221 | € 2230 | € 2260 | € 2291 | € 2323 | € 2436 |
| 2100 | € 2013 | € 2029 | € 2042 | € 2076 | € 2106 | € 2137 | € 2166 | € 2194 | € 2228 | € 2257 | € 2265 | € 2296 | € 2327 | € 2355 | € 2475 |
| 2200 | € 2052 | € 2063 | € 2072 | € 2101 | € 2125 | € 2155 | € 2181 | € 2206 | € 2232 | € 2295 | € 2307 | € 2338 | € 2364 | € 2397 | € 2515 |
| 2300 | € 2092 | € 2107 | € 2123 | € 2153 | € 2183 | € 2211 | € 2245 | € 2273 | € 2303 | € 2332 | € 2342 | € 2371 | € 2399 | € 2427 | € 2546 |
| 2400 | € 2133 | € 2148 | € 2160 | € 2190 | € 2221 | € 2253 | € 2280 | € 2310 | € 2341 | € 2371 | € 2377 | € 2407 | € 2434 | € 2462 | € 2579 |
| 2500 | € 2172 | € 2185 | € 2198 | € 2230 | € 2260 | € 2287 | € 2322 | € 2347 | € 2377 | € 2407 | € 2416 | € 2443 | € 2469 | € 2499 | € 2612 |
| 2600 | € 2211 | € 2232 | € 2250 | € 2283 | € 2316 | € 2350 | € 2382 | € 2417 | € 2447 | € 2480 | € 2495 | € 2525 | € 2556 | € 2589 | € 2709 |
| 2700 | € 2253 | € 2270 | € 2287 | € 2323 | € 2355 | € 2386 | € 2420 | € 2452 | € 2485 | € 2517 | € 2530 | € 2561 | € 2595 | € 2624 | € 2743 |
| 2800 | € 2293 | € 2307 | € 2325 | € 2358 | € 2390 | € 2426 | € 2457 | € 2487 | € 2521 | € 2552 | € 2566 | € 2596 | € 2626 | € 2659 | € 2792 |
| 2900 | € 2334 | € 2350 | € 2364 | € 2397 | € 2432 | € 2465 | € 2499 | € 2530 | € 2560 | € 2595 | € 2604 | € 2634 | € 2667 | € 2696 | |
| 3000 | € 2372 | € 2388 | € 2406 | € 2436 | € 2469 | € 2504 | € 2534 | € 2566 | € 2599 | € 2630 | € 2639 | € 2671 | € 2701 | € 2732 | |

Prices excluding VAT

| 2500 | 2600 | 2700 | 2800 | 2900 | 3000 | 3100 | 3200 | 3300 | 3400 | 3500 | 3600 | 3700 | 3800 | 3900 | 4000 |
|--------|--------|--------|--------|--------|--------|--------|--------|--------|--------|--------|--------|--------|--------|--------|--------|
| € 1234 | € 1259 | € 1284 | € 1311 | € 1339 | € 1364 | € 1418 | € 1445 | € 1473 | € 1500 | € 1523 | € 1550 | € 1577 | € 1605 | € 1629 | € 1657 |
| € 1259 | € 1284 | € 1313 | € 1339 | € 1368 | € 1420 | € 1449 | € 1475 | € 1504 | € 1530 | € 1554 | € 1583 | € 1608 | € 1637 | € 1662 | € 1691 |
| € 1284 | € 1311 | € 1339 | € 1368 | € 1423 | € 1449 | € 1477 | € 1506 | € 1533 | € 1559 | € 1589 | € 1614 | € 1643 | € 1671 | € 1698 | € 1723 |
| € 1311 | € 1339 | € 1368 | € 1423 | € 1451 | € 1477 | € 1506 | € 1535 | € 1562 | € 1590 | € 1619 | € 1647 | € 1676 | € 1704 | € 1732 | € 1788 |
| € 1337 | € 1364 | € 1420 | € 1449 | € 1477 | € 1509 | € 1537 | € 1567 | € 1592 | € 1621 | € 1649 | € 1679 | € 1710 | € 1738 | € 1764 | € 1822 |
| € 1361 | € 1418 | € 1449 | € 1477 | € 1506 | € 1537 | € 1567 | € 1592 | € 1624 | € 1653 | € 1683 | € 1712 | € 1740 | € 1799 | € 1828 | € 1855 |
| € 1416 | € 1447 | € 1475 | € 1506 | € 1535 | € 1567 | € 1595 | € 1624 | € 1655 | € 1683 | € 1714 | € 1742 | € 1774 | € 1833 | € 1861 | € 1892 |
| € 1442 | € 1473 | € 1504 | € 1533 | € 1562 | € 1592 | € 1624 | € 1655 | € 1683 | € 1714 | € 1746 | € 1805 | € 1836 | € 1864 | € 1894 | € 1926 |
| € 1468 | € 1500 | € 1530 | € 1559 | € 1590 | € 1621 | € 1653 | € 1683 | € 1714 | € 1746 | € 1776 | € 1836 | € 1865 | € 1897 | € 1928 | € 1959 |
| € 1492 | € 1523 | € 1557 | € 1589 | € 1619 | € 1649 | € 1683 | € 1714 | € 1746 | € 1805 | € 1838 | € 1870 | € 1900 | € 1930 | € 1964 | € 1995 |
| € 1519 | € 1553 | € 1583 | € 1616 | € 1647 | € 1680 | € 1712 | € 1746 | € 1776 | € 1836 | € 1870 | € 1900 | € 1932 | € 1964 | € 1996 | € 2028 |

| 2500 | 2600 | 2700 | 2800 | 2900 | 3000 | 3100 | 3200 | 3300 | 3400 | 3500 | 3600 | 3700 | 3800 | 3900 | 4000 |
|--------|--------|--------|--------|--------|--------|--------|--------|--------|--------|--------|--------|--------|--------|--------|--------|
| € 1435 | € 1464 | € 1495 | € 1521 | € 1555 | € 1583 | € 1614 | € 1643 | € 1676 | € 1706 | € 1737 | € 1767 | € 1798 | € 1828 | € 1855 | € 1890 |
| € 1464 | € 1495 | € 1524 | € 1555 | € 1588 | € 1617 | € 1651 | € 1678 | € 1712 | € 1741 | € 1771 | € 1806 | € 1833 | € 1865 | € 1896 | € 1928 |
| € 1495 | € 1521 | € 1555 | € 1588 | € 1620 | € 1651 | € 1682 | € 1716 | € 1746 | € 1777 | € 1811 | € 1838 | € 1871 | € 1907 | € 1935 | € 1965 |
| € 1521 | € 1555 | € 1588 | € 1620 | € 1653 | € 1682 | € 1716 | € 1747 | € 1778 | € 1812 | € 1845 | € 1875 | € 1910 | € 1943 | € 1975 | € 2008 |
| € 1553 | € 1583 | € 1617 | € 1651 | € 1682 | € 1718 | € 1750 | € 1783 | € 1816 | € 1847 | € 1878 | € 1912 | € 1947 | € 1982 | € 2068 | € 2101 |
| € 1581 | € 1614 | € 1651 | € 1682 | € 1716 | € 1750 | € 1783 | € 1816 | € 1850 | € 1882 | € 1917 | € 1949 | € 1985 | € 2076 | € 2106 | € 2141 |
| € 1610 | € 1648 | € 1678 | € 1716 | € 1747 | € 1783 | € 1817 | € 1850 | € 1887 | € 1917 | € 2008 | € 2042 | € 2078 | € 2110 | € 2145 | € 2181 |
| € 1642 | € 1676 | € 1712 | € 1746 | € 1778 | € 1816 | € 1850 | € 1887 | € 1917 | € 2008 | € 2046 | € 2081 | € 2117 | € 2148 | € 2183 | € 2221 |
| € 1672 | € 1706 | € 1741 | € 1777 | € 1812 | € 1847 | € 1882 | € 1917 | € 2008 | € 2046 | € 2081 | € 2117 | € 2151 | € 2185 | € 2222 | € 2257 |
| € 1699 | € 1737 | € 1773 | € 1811 | € 1845 | € 1878 | € 1917 | € 2008 | € 2046 | € 2081 | € 2121 | € 2155 | € 2188 | € 2225 | € 2263 | € 2300 |
| € 1731 | € 1769 | € 1806 | € 1843 | € 1875 | € 1971 | € 2005 | € 2046 | € 2081 | € 2117 | € 2155 | € 2188 | € 2228 | € 2263 | € 2303 | € 2338 |
| 5600 | 5700 | 5800 | 5900 | 6000 | 6100 | 6200 | 6300 | 6400 | 6500 | 6600 | 6700 | 6800 | 6900 | 7000 | |
| € 2466 | € 2499 | € 2527 | € 2556 | € 2587 | € 2637 | € 2665 | € 2694 | € 2722 | € 2748 | € 2775 | € 2803 | € 2829 | € 2860 | € 2888 | |
| € 2501 | € 2531 | € 2561 | € 2589 | € 2620 | € 2673 | € 2704 | € 2733 | € 2765 | € 2793 | € 2824 | € 2855 | € 2884 | € 2912 | € 2945 | |
| € 2540 | € 2574 | € 2604 | € 2631 | € 2664 | € 2717 | € 2744 | € 2775 | € 2806 | € 2835 | € 2867 | € 2896 | € 2926 | € 2956 | € 2986 | |
| € 2574 | € 2601 | € 2630 | € 2656 | € 2684 | € 2733 | € 2762 | € 2790 | € 2816 | € 2844 | € 2871 | € 2898 | € 2926 | € 2955 | € 2982 | |
| € 2606 | € 2634 | € 2661 | € 2690 | € 2717 | € 2767 | € 2793 | € 2821 | € 2851 | € 2875 | € 2903 | € 2932 | € 2959 | € 2986 | € 3012 | |
| € 2639 | € 2670 | € 2693 | € 2721 | € 2750 | € 2793 | € 2819 | € 2844 | € 2869 | € 2893 | € 2918 | € 2945 | € 2969 | € 2993 | € 3021 | |
| € 2740 | € 2771 | € 2801 | € 2836 | € 2866 | | | | | | | | | | | |
| € 2774 | € 2804 | € 2836 | € 2866 | € 2896 | | | | | | | | | | | |
| € 2821 | € 2855 | € 2884 | € 2915 | € 2947 | | | | | | | | | | | |

These prices apply to standard colours and trend colours. A surcharge of 15% applies for special RAL colours.
If a sunblind is ordered separately from a canopy roof, a flat-rate surcharge of € 200 applies.

C

Gross prices AXIOM 100 obstacle detec

| Width (mm) → ↓ Height (mm) | 1000 | 1100 | 1200 | 1300 | 1400 | 1500 | 1600 | 1700 | 1800 | 1900 | 2000 | 2100 | 2200 | 2300 | 2400 |
|-------------------------------|--------|--------|--------|--------|--------|--------|--------|--------|--------|--------|--------|--------|--------|--------|--------|
| 2000 | € 938 | € 965 | € 989 | € 1018 | € 1044 | € 1069 | € 1095 | € 1123 | € 1149 | € 1173 | € 1200 | € 1228 | € 1253 | € 1280 | € 1305 |
| 2100 | € 956 | € 983 | € 1008 | € 1036 | € 1061 | € 1091 | € 1114 | € 1144 | € 1169 | € 1198 | € 1223 | € 1252 | € 1276 | € 1305 | € 1331 |
| 2200 | € 972 | € 1000 | € 1028 | € 1054 | € 1081 | € 1110 | € 1136 | € 1163 | € 1191 | € 1220 | € 1247 | € 1275 | € 1302 | € 1328 | € 1356 |
| 2300 | € 989 | € 1018 | € 1046 | € 1074 | € 1102 | € 1132 | € 1159 | € 1185 | € 1214 | € 1240 | € 1270 | € 1298 | € 1325 | € 1354 | € 1383 |
| 2400 | € 1008 | € 1036 | € 1065 | € 1093 | € 1120 | € 1151 | € 1180 | € 1207 | € 1236 | € 1265 | € 1292 | € 1320 | € 1349 | € 1379 | € 1408 |
| 2500 | € 1026 | € 1054 | € 1081 | € 1113 | € 1141 | € 1169 | € 1200 | € 1228 | € 1256 | € 1287 | € 1315 | € 1347 | € 1375 | € 1403 | € 1435 |
| 2600 | € 1041 | € 1073 | € 1100 | € 1132 | € 1162 | € 1190 | € 1220 | € 1249 | € 1280 | € 1311 | € 1339 | € 1370 | € 1396 | € 1427 | € 1455 |
| 2700 | € 1059 | € 1091 | € 1120 | € 1149 | € 1180 | € 1211 | € 1240 | € 1272 | € 1301 | € 1331 | € 1360 | € 1392 | € 1422 | € 1452 | € 1497 |
| 2800 | € 1077 | € 1108 | € 1138 | € 1169 | € 1200 | € 1230 | € 1262 | € 1292 | € 1322 | € 1354 | € 1384 | € 1416 | € 1445 | € 1493 | € 1524 |
| 2900 | € 1095 | € 1126 | € 1156 | € 1187 | € 1220 | € 1252 | € 1282 | € 1313 | € 1347 | € 1377 | € 1408 | € 1439 | € 1486 | € 1519 | € 1551 |
| 3000 | € 1110 | € 1144 | € 1173 | € 1207 | € 1238 | € 1272 | € 1302 | € 1338 | € 1367 | € 1396 | € 1432 | € 1477 | € 1510 | € 1541 | € 1574 |

D

Gross prices AXIOM 130 obstacle detec

| Width (mm) → ↓ Height (mm) | 1000 | 1100 | 1200 | 1300 | 1400 | 1500 | 1600 | 1700 | 1800 | 1900 | 2000 | 2100 | 2200 | 2300 | 2400 |
|-------------------------------|--------|--------|--------|--------|--------|--------|--------|--------|--------|--------|--------|--------|--------|--------|--------|
| 2000 | € 1039 | € 1068 | € 1097 | € 1127 | € 1160 | € 1187 | € 1217 | € 1252 | € 1280 | € 1309 | € 1339 | € 1371 | € 1413 | € 1445 | € 1473 |
| 2100 | € 1061 | € 1088 | € 1117 | € 1150 | € 1182 | € 1212 | € 1243 | € 1275 | € 1301 | € 1336 | € 1365 | € 1397 | € 1443 | € 1473 | € 1503 |
| 2200 | € 1078 | € 1108 | € 1141 | € 1170 | € 1202 | € 1238 | € 1265 | € 1297 | € 1332 | € 1362 | € 1392 | € 1425 | € 1470 | € 1501 | € 1534 |
| 2300 | € 1097 | € 1127 | € 1163 | € 1195 | € 1226 | € 1261 | € 1292 | € 1320 | € 1355 | € 1386 | € 1420 | € 1453 | € 1496 | € 1531 | € 1565 |
| 2400 | € 1117 | € 1150 | € 1183 | € 1215 | € 1248 | € 1283 | € 1316 | € 1348 | € 1380 | € 1416 | € 1446 | € 1489 | € 1525 | € 1558 | € 1589 |
| 2500 | € 1137 | € 1170 | € 1202 | € 1240 | € 1272 | € 1301 | € 1339 | € 1371 | € 1401 | € 1439 | € 1471 | € 1522 | € 1553 | € 1585 | € 1623 |
| 2600 | € 1157 | € 1192 | € 1222 | € 1261 | € 1296 | € 1327 | € 1362 | € 1394 | € 1432 | € 1466 | € 1496 | € 1548 | € 1578 | € 1613 | € 1648 |
| 2700 | € 1177 | € 1212 | € 1248 | € 1280 | € 1316 | € 1353 | € 1386 | € 1422 | € 1456 | € 1490 | € 1524 | € 1573 | € 1610 | € 1643 | € 1677 |
| 2800 | € 1197 | € 1232 | € 1267 | € 1301 | € 1339 | € 1374 | € 1410 | € 1446 | € 1479 | € 1518 | € 1553 | € 1601 | € 1635 | € 1670 | € 1708 |
| 2900 | € 1217 | € 1254 | € 1287 | € 1323 | € 1362 | € 1397 | € 1434 | € 1469 | € 1509 | € 1541 | € 1576 | € 1627 | € 1662 | € 1704 | € 1737 |
| 3000 | € 1238 | € 1275 | € 1309 | € 1348 | € 1383 | € 1422 | € 1457 | € 1495 | € 1531 | € 1565 | € 1606 | € 1653 | € 1692 | € 1727 | € 1764 |
| Width (mm) → ↓ Height (mm) | 4100 | 4200 | 4300 | 4400 | 4500 | 4600 | 4700 | 4800 | 4900 | 5000 | 5100 | 5200 | 5300 | 5400 | 5500 |
| 2000 | € 2011 | € 2023 | € 2034 | € 2065 | € 2097 | € 2127 | € 2155 | € 2189 | € 2219 | € 2250 | € 2259 | € 2289 | € 2320 | € 2352 | € 2464 |
| 2100 | € 2041 | € 2058 | € 2071 | € 2105 | € 2135 | € 2165 | € 2195 | € 2223 | € 2256 | € 2285 | € 2294 | € 2325 | € 2356 | € 2384 | € 2504 |
| 2200 | € 2081 | € 2092 | € 2101 | € 2129 | € 2154 | € 2184 | € 2210 | € 2235 | € 2261 | € 2324 | € 2336 | € 2367 | € 2393 | € 2425 | € 2544 |
| 2300 | € 2121 | € 2136 | € 2152 | € 2181 | € 2212 | € 2240 | € 2274 | € 2302 | € 2332 | € 2360 | € 2371 | € 2399 | € 2428 | € 2456 | € 2575 |
| 2400 | € 2162 | € 2177 | € 2189 | € 2219 | € 2250 | € 2282 | € 2308 | € 2339 | € 2370 | € 2399 | € 2406 | € 2436 | € 2463 | € 2491 | € 2608 |
| 2500 | € 2201 | € 2214 | € 2227 | € 2259 | € 2289 | € 2316 | € 2351 | € 2376 | € 2406 | € 2436 | € 2445 | € 2471 | € 2498 | € 2528 | € 2641 |
| 2600 | € 2240 | € 2261 | € 2279 | € 2311 | € 2345 | € 2379 | € 2411 | € 2446 | € 2476 | € 2509 | € 2523 | € 2554 | € 2585 | € 2618 | € 2738 |
| 2700 | € 2282 | € 2299 | € 2316 | € 2352 | € 2384 | € 2415 | € 2448 | € 2481 | € 2514 | € 2546 | € 2559 | € 2590 | € 2624 | € 2653 | € 2772 |
| 2800 | € 2321 | € 2336 | € 2354 | € 2386 | € 2419 | € 2455 | € 2486 | € 2516 | € 2550 | € 2581 | € 2595 | € 2625 | € 2655 | € 2688 | € 2850 |
| 2900 | € 2363 | € 2379 | € 2393 | € 2425 | € 2461 | € 2494 | € 2528 | € 2559 | € 2588 | € 2624 | € 2633 | € 2663 | € 2696 | € 2725 | |
| 3000 | € 2401 | € 2417 | € 2435 | € 2464 | € 2498 | € 2533 | € 2562 | € 2595 | € 2627 | € 2659 | € 2668 | € 2700 | € 2730 | € 2761 | |

Prices excluding VAT

| 2500 | 2600 | 2700 | 2800 | 2900 | 3000 | 3100 | 3200 | 3300 | 3400 | 3500 | 3600 | 3700 | 3800 | 3900 | 4000 |
|--------|--------|--------|--------|--------|--------|--------|--------|--------|--------|--------|--------|--------|--------|--------|--------|
| € 1334 | € 1359 | € 1384 | € 1411 | € 1439 | € 1464 | € 1505 | € 1531 | € 1560 | € 1586 | € 1610 | € 1637 | € 1664 | € 1691 | € 1716 | € 1743 |
| € 1359 | € 1384 | € 1413 | € 1439 | € 1468 | € 1507 | € 1536 | € 1561 | € 1591 | € 1617 | € 1641 | € 1670 | € 1695 | € 1724 | € 1749 | € 1778 |
| € 1384 | € 1411 | € 1439 | € 1468 | € 1510 | € 1536 | € 1563 | € 1593 | € 1619 | € 1645 | € 1675 | € 1700 | € 1729 | € 1758 | € 1785 | € 1810 |
| € 1411 | € 1439 | € 1468 | € 1510 | € 1537 | € 1563 | € 1593 | € 1622 | € 1649 | € 1677 | € 1706 | € 1734 | € 1762 | € 1791 | € 1818 | € 1859 |
| € 1437 | € 1464 | € 1507 | € 1536 | € 1563 | € 1596 | € 1624 | € 1654 | € 1679 | € 1707 | € 1736 | € 1765 | € 1797 | € 1825 | € 1851 | € 1893 |
| € 1461 | € 1505 | € 1536 | € 1563 | € 1593 | € 1624 | € 1654 | € 1679 | € 1711 | € 1739 | € 1769 | € 1798 | € 1827 | € 1871 | € 1899 | € 1926 |
| € 1502 | € 1534 | € 1561 | € 1593 | € 1622 | € 1654 | € 1682 | € 1711 | € 1742 | € 1769 | € 1801 | € 1829 | € 1861 | € 1904 | € 1933 | € 1963 |
| € 1528 | € 1560 | € 1591 | € 1619 | € 1649 | € 1679 | € 1711 | € 1742 | € 1769 | € 1801 | € 1833 | € 1876 | € 1907 | € 1935 | € 1965 | € 1997 |
| € 1555 | € 1586 | € 1617 | € 1645 | € 1677 | € 1707 | € 1739 | € 1769 | € 1801 | € 1833 | € 1863 | € 1907 | € 1936 | € 1968 | € 1999 | € 2030 |
| € 1579 | € 1610 | € 1644 | € 1675 | € 1706 | € 1736 | € 1769 | € 1801 | € 1833 | € 1876 | € 1910 | € 1941 | € 1971 | € 2001 | € 2035 | € 2066 |
| € 1606 | € 1639 | € 1670 | € 1703 | € 1734 | € 1767 | € 1798 | € 1833 | € 1863 | € 1907 | € 1941 | € 1971 | € 2003 | € 2035 | € 2067 | € 2099 |

| 2500 | 2600 | 2700 | 2800 | 2900 | 3000 | 3100 | 3200 | 3300 | 3400 | 3500 | 3600 | 3700 | 3800 | 3900 | 4000 |
|--------|--------|--------|--------|--------|--------|--------|--------|--------|--------|--------|--------|--------|--------|--------|--------|
| € 1506 | € 1535 | € 1566 | € 1592 | € 1627 | € 1654 | € 1685 | € 1714 | € 1747 | € 1777 | € 1809 | € 1838 | € 1869 | € 1899 | € 1926 | € 1962 |
| € 1535 | € 1566 | € 1595 | € 1627 | € 1659 | € 1688 | € 1722 | € 1749 | € 1783 | € 1812 | € 1842 | € 1877 | € 1904 | € 1936 | € 1967 | € 1999 |
| € 1566 | € 1592 | € 1627 | € 1659 | € 1692 | € 1722 | € 1753 | € 1787 | € 1817 | € 1848 | € 1882 | € 1910 | € 1942 | € 1978 | € 2006 | € 2037 |
| € 1592 | € 1627 | € 1659 | € 1692 | € 1724 | € 1753 | € 1787 | € 1819 | € 1849 | € 1884 | € 1916 | € 1946 | € 1981 | € 2014 | € 2046 | € 2079 |
| € 1624 | € 1654 | € 1688 | € 1722 | € 1753 | € 1789 | € 1822 | € 1854 | € 1887 | € 1918 | € 1949 | € 1983 | € 2018 | € 2053 | € 2097 | € 2129 |
| € 1653 | € 1685 | € 1722 | € 1753 | € 1787 | € 1822 | € 1854 | € 1887 | € 1921 | € 1953 | € 1988 | € 2020 | € 2056 | € 2105 | € 2135 | € 2170 |
| € 1682 | € 1719 | € 1749 | € 1787 | € 1819 | € 1854 | € 1888 | € 1921 | € 1959 | € 1988 | € 2037 | € 2071 | € 2106 | € 2139 | € 2174 | € 2210 |
| € 1713 | € 1747 | € 1783 | € 1817 | € 1849 | € 1887 | € 1921 | € 1959 | € 1988 | € 2037 | € 2075 | € 2110 | € 2145 | € 2177 | € 2212 | € 2250 |
| € 1743 | € 1777 | € 1812 | € 1848 | € 1884 | € 1918 | € 1953 | € 1988 | € 2037 | € 2075 | € 2110 | € 2145 | € 2180 | € 2214 | € 2251 | € 2285 |
| € 1770 | € 1809 | € 1845 | € 1882 | € 1916 | € 1949 | € 1988 | € 2037 | € 2075 | € 2110 | € 2150 | € 2184 | € 2217 | € 2254 | € 2292 | € 2329 |
| € 1802 | € 1840 | € 1877 | € 1914 | € 1946 | € 1999 | € 2034 | € 2075 | € 2110 | € 2145 | € 2184 | € 2217 | € 2256 | € 2292 | € 2332 | € 2367 |
| 5600 | 5700 | 5800 | 5900 | 6000 | 6100 | 6200 | 6300 | 6400 | 6500 | 6600 | 6700 | 6800 | 6900 | 7000 | |
| € 2495 | € 2528 | € 2556 | € 2585 | € 2616 | € 2637 | € 2665 | € 2694 | € 2722 | € 2748 | € 2775 | € 2803 | € 2829 | € 2860 | € 2888 | |
| € 2530 | € 2560 | € 2590 | € 2618 | € 2649 | € 2673 | € 2704 | € 2733 | € 2765 | € 2793 | € 2824 | € 2855 | € 2884 | € 2912 | € 2945 | |
| € 2569 | € 2603 | € 2633 | € 2660 | € 2692 | € 2717 | € 2744 | € 2775 | € 2806 | € 2835 | € 2867 | € 2896 | € 2926 | € 2956 | € 2986 | |
| € 2603 | € 2630 | € 2659 | € 2685 | € 2713 | € 2733 | € 2762 | € 2790 | € 2816 | € 2844 | € 2871 | € 2898 | € 2926 | € 2955 | € 2982 | |
| € 2635 | € 2663 | € 2690 | € 2718 | € 2746 | € 2767 | € 2793 | € 2821 | € 2851 | € 2875 | € 2903 | € 2932 | € 2959 | € 2986 | € 3012 | |
| € 2668 | € 2699 | € 2722 | € 2750 | € 2779 | € 2793 | € 2819 | € 2844 | € 2869 | € 2893 | € 2918 | € 2945 | € 2969 | € 2993 | € 3021 | |
| € 2769 | € 2800 | € 2859 | € 2893 | € 2923 | | | | | | | | | | | |
| € 2832 | € 2861 | € 2893 | € 2923 | € 2954 | | | | | | | | | | | |
| € 2879 | € 2913 | € 2942 | € 2972 | € 3004 | | | | | | | | | | | |

These prices apply to standard colours and trend colours. A surcharge of 15% applies for special RAL colours.
If a sunblind is ordered separately from a canopy roof, a flat-rate surcharge of € 200 applies.

E

| Gross prices AXIOM 100 solar | | | | | | | | | | | | | | | | |
|-------------------------------|--------|--------|--------|--------|--------|--------|--------|--------|--------|--------|--------|--------|--------|--------|--------|--|
| Width (mm) → ↓ Height (mm) | 1000 | 1100 | 1200 | 1300 | 1400 | 1500 | 1600 | 1700 | 1800 | 1900 | 2000 | 2100 | 2200 | 2300 | 2400 | |
| 2000 | € 1189 | € 1216 | € 1240 | € 1269 | € 1295 | € 1320 | € 1346 | € 1374 | € 1400 | € 1424 | € 1451 | € 1479 | € 1504 | € 1531 | € 1556 | |
| 2100 | € 1207 | € 1234 | € 1259 | € 1287 | € 1312 | € 1342 | € 1365 | € 1395 | € 1420 | € 1449 | € 1474 | € 1503 | € 1527 | € 1556 | € 1582 | |
| 2200 | € 1223 | € 1251 | € 1279 | € 1306 | € 1332 | € 1361 | € 1387 | € 1414 | € 1442 | € 1471 | € 1498 | € 1526 | € 1553 | € 1579 | € 1607 | |
| 2300 | € 1240 | € 1269 | € 1297 | € 1325 | € 1353 | € 1383 | € 1410 | € 1436 | € 1465 | € 1491 | € 1521 | € 1549 | € 1576 | € 1605 | € 1634 | |
| 2400 | € 1259 | € 1287 | € 1316 | € 1344 | € 1371 | € 1402 | € 1431 | € 1459 | € 1487 | € 1516 | € 1543 | € 1571 | € 1600 | € 1630 | € 1659 | |
| 2500 | € 1277 | € 1306 | € 1332 | € 1364 | € 1392 | € 1420 | € 1451 | € 1479 | € 1507 | € 1538 | € 1566 | € 1598 | € 1626 | € 1654 | € 1686 | |
| 2600 | € 1292 | € 1324 | € 1351 | € 1383 | € 1413 | € 1441 | € 1471 | € 1500 | € 1531 | € 1562 | € 1590 | € 1621 | € 1647 | € 1678 | € 1706 | |
| 2700 | € 1310 | € 1342 | € 1371 | € 1400 | € 1431 | € 1462 | € 1491 | € 1523 | € 1552 | € 1582 | € 1612 | € 1643 | € 1673 | € 1703 | € 1761 | |
| 2800 | € 1328 | € 1359 | € 1389 | € 1420 | € 1451 | € 1481 | € 1513 | € 1543 | € 1573 | € 1605 | € 1635 | € 1667 | € 1696 | € 1757 | € 1788 | |
| 2900 | € 1346 | € 1377 | € 1407 | € 1438 | € 1471 | € 1503 | € 1533 | € 1564 | € 1598 | € 1628 | € 1659 | € 1690 | € 1751 | € 1783 | € 1816 | |
| 3000 | € 1361 | € 1395 | € 1424 | € 1459 | € 1489 | € 1523 | € 1553 | € 1589 | € 1618 | € 1647 | € 1683 | € 1741 | € 1774 | € 1806 | € 1839 | |

F

| Gross prices AXIOM 130 solar | | | | | | | | | | | | | | | | |
|-------------------------------|--------|--------|--------|--------|--------|--------|--------|--------|--------|--------|--------|--------|--------|--------|--------|--|
| Width (mm) → ↓ Height (mm) | 1000 | 1100 | 1200 | 1300 | 1400 | 1500 | 1600 | 1700 | 1800 | 1900 | 2000 | 2100 | 2200 | 2300 | 2400 | |
| 2000 | € 1303 | € 1332 | € 1361 | € 1392 | € 1425 | € 1451 | € 1481 | € 1516 | € 1545 | € 1574 | € 1603 | € 1636 | € 1886 | € 1918 | € 1946 | |
| 2100 | € 1325 | € 1353 | € 1382 | € 1415 | € 1446 | € 1477 | € 1507 | € 1539 | € 1565 | € 1601 | € 1630 | € 1661 | € 1916 | € 1946 | € 1977 | |
| 2200 | € 1343 | € 1373 | € 1406 | € 1435 | € 1467 | € 1502 | € 1529 | € 1562 | € 1597 | € 1627 | € 1656 | € 1689 | € 1944 | € 1974 | € 2007 | |
| 2300 | € 1361 | € 1392 | € 1428 | € 1460 | € 1490 | € 1525 | € 1556 | € 1585 | € 1620 | € 1650 | € 1685 | € 1717 | € 1970 | € 2004 | € 2038 | |
| 2400 | € 1382 | € 1415 | € 1448 | € 1480 | € 1513 | € 1547 | € 1580 | € 1612 | € 1644 | € 1680 | € 1710 | € 1962 | € 1998 | € 2032 | € 2062 | |
| 2500 | € 1402 | € 1435 | € 1467 | € 1504 | € 1536 | € 1565 | € 1603 | € 1636 | € 1666 | € 1703 | € 1735 | € 1996 | € 2026 | € 2058 | € 2096 | |
| 2600 | € 1422 | € 1457 | € 1487 | € 1525 | € 1560 | € 1591 | € 1627 | € 1659 | € 1696 | € 1730 | € 1760 | € 2021 | € 2051 | € 2087 | € 2121 | |
| 2700 | € 1441 | € 1477 | € 1513 | € 1545 | € 1580 | € 1617 | € 1650 | € 1686 | € 1720 | € 1754 | € 1789 | € 2046 | € 2083 | € 2116 | € 2150 | |
| 2800 | € 1461 | € 1497 | € 1532 | € 1565 | € 1603 | € 1639 | € 1674 | € 1710 | € 1744 | € 1782 | € 1817 | € 2074 | € 2108 | € 2143 | € 2181 | |
| 2900 | € 1481 | € 1519 | € 1552 | € 1588 | € 1627 | € 1661 | € 1699 | € 1734 | € 1773 | € 1806 | € 1840 | € 2100 | € 2136 | € 2177 | € 2211 | |
| 3000 | € 1502 | € 1539 | € 1574 | € 1612 | € 1647 | € 1686 | € 1721 | € 1759 | € 1796 | € 1829 | € 1871 | € 2126 | € 2165 | € 2200 | € 2237 | |
| Width (mm) → ↓ Height (mm) | 4100 | 4200 | 4300 | 4400 | 4500 | 4600 | 4700 | 4800 | 4900 | 5000 | | | | | | |
| 2000 | € 2571 | € 2583 | € 2594 | € 2625 | € 2656 | € 2687 | € 2715 | € 2749 | € 2779 | € 2809 | | | | | | |
| 2100 | € 2601 | € 2617 | € 2631 | € 2665 | € 2695 | € 2725 | € 2755 | € 2783 | € 2816 | € 2845 | | | | | | |
| 2200 | € 2641 | € 2652 | € 2661 | € 2689 | € 2714 | € 2744 | € 2770 | € 2795 | € 2821 | € 2884 | | | | | | |
| 2300 | € 2681 | € 2696 | € 2711 | € 2741 | € 2772 | € 2800 | € 2834 | € 2861 | € 2892 | € 2920 | | | | | | |
| 2400 | € 2722 | € 2737 | € 2749 | € 2779 | € 2809 | € 2841 | € 2868 | € 2899 | € 2929 | € 2959 | | | | | | |
| 2500 | € 2761 | € 2774 | € 2786 | € 2819 | € 2849 | € 2876 | € 2910 | € 2936 | € 2965 | € 2996 | | | | | | |
| 2600 | € 2800 | € 2821 | € 2839 | € 2871 | € 2905 | € 2939 | € 2971 | € 3006 | € 3036 | € 3069 | | | | | | |
| 2700 | € 2841 | € 2859 | € 2876 | € 2912 | € 2944 | € 2975 | € 3008 | € 3041 | € 3074 | € 3106 | | | | | | |
| 2800 | € 2881 | € 2896 | € 2914 | € 2946 | € 2979 | € 3014 | € 3046 | € 3076 | € 3110 | € 3141 | | | | | | |
| 2900 | € 2923 | € 2939 | € 2953 | € 2985 | € 3020 | € 3053 | € 3088 | € 3118 | € 3148 | € 3183 | | | | | | |
| 3000 | € 2961 | € 2977 | € 2994 | € 3024 | € 3058 | € 3092 | € 3122 | € 3155 | € 3187 | | | | | | | |

Prices excluding VAT

| 2500 | 2600 | 2700 | 2800 | 2900 | 3000 | 3100 | 3200 | 3300 | 3400 | 3500 | 3600 | 3700 | 3800 | 3900 | 4000 |
|--------|--------|--------|--------|--------|--------|--------|--------|--------|--------|--------|--------|--------|--------|--------|--------|
| € 1585 | € 1610 | € 1635 | € 1662 | € 1690 | € 1715 | € 1769 | € 1796 | € 1824 | € 1851 | € 1874 | € 1901 | € 1928 | € 1956 | € 1980 | € 2008 |
| € 1610 | € 1635 | € 1664 | € 1690 | € 1719 | € 1771 | € 1800 | € 1826 | € 1855 | € 1881 | € 1905 | € 1934 | € 1959 | € 1988 | € 2013 | € 2042 |
| € 1635 | € 1662 | € 1690 | € 1719 | € 1774 | € 1800 | € 1828 | € 1857 | € 1884 | € 1910 | € 1939 | € 1965 | € 1994 | € 2022 | € 2049 | € 2074 |
| € 1662 | € 1690 | € 1719 | € 1774 | € 1802 | € 1828 | € 1857 | € 1886 | € 1913 | € 1941 | € 1970 | € 1998 | € 2027 | € 2055 | € 2083 | € 2332 |
| € 1688 | € 1715 | € 1771 | € 1800 | € 1828 | € 1860 | € 1888 | € 1918 | € 1943 | € 1972 | € 2000 | € 2030 | € 2061 | € 2089 | € 2115 | € 2366 |
| € 1712 | € 1769 | € 1800 | € 1828 | € 1857 | € 1888 | € 1918 | € 1943 | € 1975 | € 2004 | € 2034 | € 2063 | € 2091 | € 2344 | € 2372 | € 2399 |
| € 1767 | € 1798 | € 1826 | € 1857 | € 1886 | € 1918 | € 1946 | € 1975 | € 2006 | € 2034 | € 2065 | € 2093 | € 2125 | € 2377 | € 2406 | € 2436 |
| € 1793 | € 1824 | € 1855 | € 1884 | € 1913 | € 1943 | € 1975 | € 2006 | € 2034 | € 2065 | € 2097 | € 2349 | € 2380 | € 2408 | € 2439 | € 2470 |
| € 1819 | € 1851 | € 1881 | € 1910 | € 1941 | € 1972 | € 2004 | € 2034 | € 2065 | € 2097 | € 2127 | € 2380 | € 2409 | € 2442 | € 2472 | € 2504 |
| € 1843 | € 1874 | € 1908 | € 1939 | € 1970 | € 2000 | € 2034 | € 2065 | € 2097 | € 2349 | € 2383 | € 2414 | € 2444 | € 2475 | € 2508 | € 2539 |
| € 1870 | € 1904 | € 1934 | € 1967 | € 1998 | € 2031 | € 2063 | € 2097 | € 2127 | € 2380 | € 2414 | € 2444 | € 2476 | € 2508 | € 2540 | € 2572 |

| 2500 | 2600 | 2700 | 2800 | 2900 | 3000 | 3100 | 3200 | 3300 | 3400 | 3500 | 3600 | 3700 | 3800 | 3900 | 4000 |
|--------|--------|--------|--------|--------|--------|--------|--------|--------|--------|--------|--------|--------|--------|--------|--------|
| € 1979 | € 2009 | € 2039 | € 2065 | € 2100 | € 2127 | € 2159 | € 2188 | € 2221 | € 2250 | € 2282 | € 2312 | € 2342 | € 2372 | € 2399 | € 2435 |
| € 2009 | € 2039 | € 2068 | € 2100 | € 2132 | € 2161 | € 2195 | € 2222 | € 2256 | € 2286 | € 2315 | € 2351 | € 2377 | € 2409 | € 2440 | € 2472 |
| € 2039 | € 2065 | € 2100 | € 2132 | € 2165 | € 2195 | € 2226 | € 2260 | € 2290 | € 2321 | € 2355 | € 2383 | € 2416 | € 2451 | € 2479 | € 2510 |
| € 2065 | € 2100 | € 2132 | € 2165 | € 2198 | € 2226 | € 2260 | € 2292 | € 2322 | € 2357 | € 2390 | € 2419 | € 2455 | € 2488 | € 2520 | € 2552 |
| € 2097 | € 2127 | € 2161 | € 2195 | € 2226 | € 2263 | € 2295 | € 2327 | € 2360 | € 2391 | € 2423 | € 2456 | € 2491 | € 2527 | € 2656 | € 2689 |
| € 2126 | € 2159 | € 2195 | € 2226 | € 2260 | € 2295 | € 2327 | € 2360 | € 2394 | € 2426 | € 2462 | € 2494 | € 2530 | € 2665 | € 2695 | € 2730 |
| € 2155 | € 2192 | € 2222 | € 2260 | € 2292 | € 2327 | € 2361 | € 2394 | € 2432 | € 2462 | € 2597 | € 2631 | € 2666 | € 2698 | € 2734 | € 2770 |
| € 2186 | € 2221 | € 2256 | € 2290 | € 2322 | € 2360 | € 2394 | € 2432 | € 2462 | € 2597 | € 2635 | € 2670 | € 2705 | € 2737 | € 2772 | € 2809 |
| € 2216 | € 2250 | € 2286 | € 2321 | € 2357 | € 2391 | € 2426 | € 2462 | € 2597 | € 2635 | € 2670 | € 2705 | € 2740 | € 2774 | € 2811 | € 2845 |
| € 2243 | € 2282 | € 2318 | € 2355 | € 2390 | € 2423 | € 2462 | € 2597 | € 2635 | € 2670 | € 2710 | € 2744 | € 2776 | € 2814 | € 2851 | € 2889 |
| € 2275 | € 2313 | € 2351 | € 2387 | € 2419 | € 2559 | € 2594 | € 2635 | € 2670 | € 2705 | € 2744 | € 2776 | € 2816 | € 2851 | € 2892 | € 2926 |

These prices apply to standard colours and trend colours. A surcharge of 15% applies for special RAL colours.
If a sunblind is ordered separately from a canopy roof, a flat-rate surcharge of € 200 applies.

Guide options

- Standard guide: included in the price
- Optional Click guide (without visible screws): included in the price
- Coupling guide (for screens with common guide): € 79.85/m

Mounting support options

- Casing support for all casings in the Axiom range
- Mounting base 10mm for the Click and coupling guides: € 49.88/piece
- Spacer profile 10mm for the Click and coupling guides: € 7.50/m

Control options (Axiom range)

The screens are controlled by remote control or a wall switch. We also offer automatic actuators that respond to solar or wind exposure levels.

The Tahoma switch from Somfy enables a smart control to connect and operate your devices with your smartphone. The perfect solution for a smart home.

| Remotes | | |
|-----------------------------|-------------------------------|----------|
| Name | Description | Price |
| ① Somfy Situo 1 io pure II | Remote control 1 channel | € 60.07 |
| ② Somfy Situo 5 io pure II | Remote control 5 channels | € 94.39 |
| ③ Somfy Smooove origin 1 io | Switch 1 channel, no cable | € 47.00 |
| ④ Somfy Smooove origin 4 io | Switch 4 channels, no cables | € 92.55 |
| ⑤ Somfy Tahoma switch | Smart home hub for smartphone | € 292.15 |

| Sensors | | |
|--|--|----------|
| Name | Description | Price |
| ⑥ Somfy Sunis wirefree io | Wireless solar sensor | € 137.31 |
| ⑦ Somfy Eolis WireFree io | Wireless wind sensor | € 152.78 |
| ⑧ Somfy Soliris 230 V io | 230V powered wind and solar sensor | € 202.57 |
| ⑨ Somfy Soliris 230 V io + Somfy Ondeis 230 V AC | 230V powered wind and solar sensor & connected rain sensor | € 507.60 |

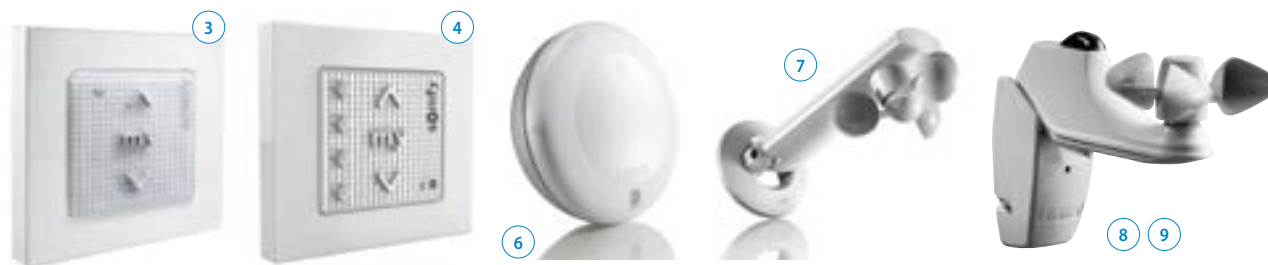

Element range

The Element screen range is distinguished by its narrow guides & lead rail, perfect for smaller screens. Casing 105mm 90° (straight casing) for screens up to 4.5m wide.

Faher motor: This affordable actuator controls your screen via a remote control (1 channel: € 41.24/piece or 2 channels: € 44.43/piece).

See table [G](#).

Faher Solar motor: This affordable actuator does not require a connection to the electricity grid. Controle via a remote control (1 channel: € 41.24/piece or 2 channels: € 44.43/piece).

See table [H](#).

Manual: A classic manual screen to protect your home and office from the sun.

Manual control with detachable winding rod: € 20/piece (1.2 to 1.8m long).

See table [I](#).



G

Gross prices Element 105

| Width (mm) → ↓ Height (mm) | 1000 | 1100 | 1200 | 1300 | 1400 | 1500 | 1600 | 1700 | 1800 | 1900 | 2000 | 2100 | 2200 | 2300 | 2400 | 2500 | 2600 |
|-------------------------------|-------|-------|-------|-------|-------|-------|-------|--------|--------|--------|--------|--------|--------|--------|--------|--------|--------|
| 1000 | € 654 | € 678 | € 695 | € 718 | € 741 | € 764 | € 784 | € 808 | € 828 | € 851 | € 871 | € 895 | € 915 | € 939 | € 961 | € 982 | € 1005 |
| 1100 | € 666 | € 692 | € 710 | € 733 | € 759 | € 780 | € 803 | € 826 | € 848 | € 869 | € 891 | € 915 | € 939 | € 959 | € 983 | € 1005 | € 1027 |
| 1200 | € 682 | € 704 | € 725 | € 748 | € 775 | € 798 | € 818 | € 844 | € 867 | € 888 | € 912 | € 936 | € 959 | € 982 | € 1005 | € 1027 | € 1050 |
| 1300 | € 695 | € 718 | € 744 | € 766 | € 789 | € 813 | € 839 | € 861 | € 884 | € 910 | € 933 | € 956 | € 979 | € 1005 | € 1027 | € 1050 | € 1077 |
| 1400 | € 708 | € 733 | € 759 | € 782 | € 808 | € 829 | € 854 | € 879 | € 903 | € 927 | € 954 | € 978 | € 1001 | € 1026 | € 1050 | € 1075 | € 1099 |
| 1500 | € 733 | € 757 | € 784 | € 810 | € 839 | € 865 | € 887 | € 915 | € 942 | € 969 | € 992 | € 1018 | € 1046 | € 1072 | € 1099 | € 1123 | € 1161 |
| 1600 | € 748 | € 768 | € 798 | € 826 | € 854 | € 883 | € 905 | € 933 | € 961 | € 990 | € 1010 | € 1038 | € 1066 | € 1094 | € 1123 | € 1160 | € 1183 |
| 1700 | € 764 | € 782 | € 810 | € 840 | € 869 | € 901 | € 923 | € 951 | € 982 | € 1010 | € 1027 | € 1059 | € 1086 | € 1119 | € 1160 | € 1181 | € 1206 |
| 1800 | € 780 | € 794 | € 822 | € 856 | € 884 | € 918 | € 942 | € 969 | € 1001 | € 1030 | € 1046 | € 1080 | € 1108 | € 1153 | € 1181 | € 1205 | € 1230 |
| 1900 | € 794 | € 808 | € 836 | € 871 | € 901 | € 936 | € 959 | € 987 | € 1024 | € 1050 | € 1063 | € 1099 | € 1141 | € 1177 | € 1205 | € 1228 | € 1254 |
| 2000 | € 810 | € 820 | € 848 | € 887 | € 915 | € 954 | € 978 | € 1005 | € 1044 | € 1072 | € 1082 | € 1133 | € 1161 | € 1200 | € 1228 | € 1249 | € 1276 |

H

Gross prices Element 105 solar

| Width (mm) → ↓ Height (mm) | 1000 | 1100 | 1200 | 1300 | 1400 | 1500 | 1600 | 1700 | 1800 | 1900 | 2000 | 2100 | 2200 | 2300 | 2400 | 2500 | 2600 |
|-------------------------------|--------|--------|--------|--------|--------|--------|--------|--------|--------|--------|--------|--------|--------|--------|--------|--------|--------|
| 1000 | € 886 | € 910 | € 928 | € 950 | € 974 | € 996 | € 1016 | € 1040 | € 1060 | € 1083 | € 1103 | € 1127 | € 1147 | € 1171 | € 1193 | € 1214 | € 1237 |
| 1100 | € 898 | € 924 | € 942 | € 965 | € 991 | € 1013 | € 1035 | € 1058 | € 1081 | € 1101 | € 1123 | € 1147 | € 1171 | € 1192 | € 1215 | € 1237 | € 1260 |
| 1200 | € 914 | € 936 | € 957 | € 980 | € 1007 | € 1030 | € 1050 | € 1076 | € 1099 | € 1120 | € 1144 | € 1169 | € 1192 | € 1214 | € 1237 | € 1260 | € 1283 |
| 1300 | € 928 | € 950 | € 976 | € 998 | € 1021 | € 1045 | € 1071 | € 1093 | € 1117 | € 1143 | € 1165 | € 1188 | € 1211 | € 1237 | € 1260 | € 1283 | € 1309 |
| 1400 | € 940 | € 965 | € 991 | € 1014 | € 1040 | € 1061 | € 1086 | € 1111 | € 1135 | € 1159 | € 1186 | € 1210 | € 1234 | € 1258 | € 1283 | € 1307 | € 1332 |
| 1500 | € 965 | € 989 | € 1016 | € 1042 | € 1071 | € 1097 | € 1119 | € 1147 | € 1174 | € 1201 | € 1224 | € 1250 | € 1278 | € 1304 | € 1332 | € 1355 | € 1381 |
| 1600 | € 980 | € 1000 | € 1030 | € 1058 | € 1086 | € 1115 | € 1137 | € 1165 | € 1193 | € 1222 | € 1242 | € 1270 | € 1299 | € 1326 | € 1355 | € 1380 | € 1403 |
| 1700 | € 996 | € 1014 | € 1042 | € 1072 | € 1101 | € 1133 | € 1155 | € 1183 | € 1214 | € 1242 | € 1260 | € 1291 | € 1319 | € 1351 | € 1380 | € 1401 | € 1426 |
| 1800 | € 1013 | € 1026 | € 1054 | € 1088 | € 1117 | € 1150 | € 1174 | € 1201 | € 1234 | € 1262 | € 1278 | € 1312 | € 1340 | € 1373 | € 1401 | € 1425 | € 1450 |
| 1900 | € 1026 | € 1040 | € 1068 | € 1103 | € 1133 | € 1169 | € 1192 | € 1219 | € 1256 | € 1283 | € 1296 | € 1332 | € 1361 | € 1397 | € 1425 | € 1448 | € 1474 |
| 2000 | € 1042 | € 1052 | € 1081 | € 1119 | € 1147 | € 1186 | € 1210 | € 1237 | € 1276 | € 1304 | € 1314 | € 1353 | € 1381 | € 1420 | € 1448 | € 1469 | € 1496 |

I

Gross prices Element 105 Manual

| Width (mm) → ↓ Height (mm) | 1000 | 1100 | 1200 | 1300 | 1400 | 1500 | 1600 | 1700 | 1800 | 1900 | 2000 | 2100 | 2200 | 2300 | 2400 | 2500 | 2600 |
|-------------------------------|-------|-------|-------|-------|-------|-------|-------|-------|-------|-------|--------|--------|--------|--------|--------|--------|--------|
| 1000 | € 582 | € 605 | € 623 | € 645 | € 669 | € 691 | € 712 | € 736 | € 755 | € 778 | € 798 | € 823 | € 843 | € 866 | € 889 | € 909 | € 933 |
| 1100 | € 593 | € 619 | € 638 | € 661 | € 687 | € 708 | € 730 | € 753 | € 776 | € 797 | € 819 | € 843 | € 866 | € 887 | € 911 | € 933 | € 955 |
| 1200 | € 609 | € 631 | € 653 | € 676 | € 703 | € 726 | € 745 | € 771 | € 794 | € 816 | € 840 | € 864 | € 887 | € 909 | € 933 | € 955 | € 978 |
| 1300 | € 623 | € 645 | € 671 | € 693 | € 716 | € 740 | € 766 | € 788 | € 812 | € 838 | € 860 | € 883 | € 907 | € 933 | € 955 | € 978 | € 1005 |
| 1400 | € 635 | € 661 | € 687 | € 710 | € 736 | € 757 | € 781 | € 807 | € 830 | € 855 | € 882 | € 905 | € 929 | € 954 | € 978 | € 1003 | € 1027 |
| 1500 | € 661 | € 684 | € 712 | € 738 | € 766 | € 792 | € 814 | € 843 | € 869 | € 897 | € 919 | € 945 | € 973 | € 999 | € 1027 | € 1051 | € 1077 |
| 1600 | € 676 | € 696 | € 726 | € 753 | € 781 | € 810 | € 833 | € 860 | € 889 | € 918 | € 937 | € 966 | € 994 | € 1022 | € 1051 | € 1075 | € 1098 |
| 1700 | € 691 | € 710 | € 738 | € 768 | € 797 | € 829 | € 850 | € 879 | € 909 | € 937 | € 955 | € 986 | € 1014 | € 1046 | € 1075 | € 1097 | € 1122 |
| 1800 | € 708 | € 722 | € 749 | € 784 | € 812 | € 846 | € 869 | € 897 | € 929 | € 957 | € 973 | € 1008 | € 1035 | € 1068 | € 1097 | € 1120 | € 1146 |
| 1900 | € 722 | € 736 | € 764 | € 798 | € 829 | € 864 | € 887 | € 915 | € 951 | € 978 | € 991 | € 1027 | € 1056 | € 1092 | € 1120 | € 1143 | € 1169 |
| 2000 | € 738 | € 748 | € 776 | € 814 | € 843 | € 882 | € 905 | € 933 | € 972 | € 999 | € 1009 | € 1048 | € 1077 | € 1115 | € 1143 | € 1165 | € 1191 |

Prices excluding VAT

| 2700 | 2800 | 2900 | 3000 | 3100 | 3200 | 3300 | 3400 | 3500 | 3600 | 3700 | 3800 | 3900 | 4000 | 4100 | 4200 | 4300 | 4400 | 4500 |
|--------|--------|--------|--------|--------|--------|--------|--------|--------|--------|--------|--------|--------|--------|--------|--------|--------|--------|--------|
| € 1026 | € 1048 | € 1068 | € 1093 | € 1128 | € 1148 | € 1169 | € 1190 | € 1209 | € 1230 | € 1249 | € 1274 | € 1295 | € 1314 | € 1335 | € 1358 | € 1376 | € 1398 | € 1437 |
| € 1050 | € 1075 | € 1094 | € 1131 | € 1153 | € 1177 | € 1197 | € 1217 | € 1240 | € 1262 | € 1284 | € 1304 | € 1326 | € 1348 | € 1370 | € 1395 | € 1417 | € 1461 | € 1484 |
| € 1075 | € 1097 | € 1135 | € 1156 | € 1181 | € 1201 | € 1226 | € 1247 | € 1268 | € 1293 | € 1314 | € 1335 | € 1359 | € 1379 | € 1399 | € 1419 | € 1461 | € 1482 | € 1502 |
| € 1099 | € 1135 | € 1161 | € 1181 | € 1206 | € 1230 | € 1254 | € 1276 | € 1300 | € 1324 | € 1344 | € 1366 | € 1389 | € 1412 | | | | | |
| € 1135 | € 1161 | € 1187 | € 1209 | € 1236 | € 1259 | € 1281 | € 1304 | € 1328 | € 1350 | € 1376 | € 1399 | € 1424 | € 1446 | | | | | |
| € 1190 | € 1214 | € 1242 | € 1266 | € 1293 | € 1320 | € 1343 | € 1368 | € 1395 | € 1417 | € 1446 | € 1469 | € 1495 | € 1539 | | | | | |
| € 1214 | € 1240 | € 1268 | € 1293 | € 1320 | € 1348 | € 1370 | € 1399 | € 1424 | € 1451 | € 1473 | € 1500 | € 1545 | € 1570 | | | | | |
| € 1240 | € 1266 | € 1295 | € 1320 | € 1344 | € 1375 | € 1399 | € 1428 | € 1452 | € 1480 | € 1505 | € 1551 | € 1575 | € 1602 | | | | | |
| € 1266 | € 1293 | € 1320 | € 1344 | € 1375 | € 1402 | € 1428 | € 1456 | € 1482 | € 1507 | € 1552 | € 1578 | € 1604 | € 1632 | | | | | |
| € 1293 | € 1317 | € 1344 | € 1370 | € 1402 | € 1431 | € 1456 | € 1483 | € 1509 | € 1556 | € 1581 | € 1606 | € 1632 | € 1663 | | | | | |
| € 1317 | € 1343 | € 1370 | € 1398 | € 1431 | € 1460 | € 1483 | € 1512 | € 1558 | € 1584 | € 1609 | € 1634 | € 1661 | € 1694 | | | | | |

| 2700 | 2800 | 2900 | 3000 | 3100 | 3200 | 3300 | 3400 | 3500 | 3600 | 3700 | 3800 | 3900 | 4000 | 4100 | 4200 | 4300 | 4400 | 4500 |
|--------|--------|--------|--------|--------|--------|--------|--------|--------|--------|--------|--------|--------|--------|--------|--------|--------|--------|--------|
| € 1258 | € 1280 | € 1300 | € 1325 | € 1348 | € 1367 | € 1389 | € 1410 | € 1429 | € 1450 | € 1469 | € 1494 | € 1515 | € 1533 | € 1555 | € 1578 | € 1596 | € 1618 | € 1666 |
| € 1283 | € 1307 | € 1326 | € 1351 | € 1373 | € 1397 | € 1417 | € 1437 | € 1460 | € 1481 | € 1504 | € 1524 | € 1546 | € 1568 | € 1590 | € 1615 | € 1637 | € 1690 | € 1713 |
| € 1307 | € 1329 | € 1355 | € 1376 | € 1401 | € 1421 | € 1446 | € 1467 | € 1488 | € 1513 | € 1533 | € 1555 | € 1579 | € 1599 | € 1619 | € 1639 | € 1690 | € 1711 | € 1731 |
| € 1332 | € 1355 | € 1381 | € 1401 | € 1426 | € 1450 | € 1474 | € 1496 | € 1520 | € 1543 | € 1564 | € 1586 | € 1609 | € 1632 | | | | | |
| € 1355 | € 1381 | € 1407 | € 1429 | € 1455 | € 1479 | € 1501 | € 1524 | € 1548 | € 1569 | € 1596 | € 1619 | € 1644 | € 1666 | | | | | |
| € 1410 | € 1434 | € 1462 | € 1486 | € 1513 | € 1540 | € 1563 | € 1588 | € 1615 | € 1637 | € 1666 | € 1689 | € 1715 | € 1768 | | | | | |
| € 1434 | € 1460 | € 1488 | € 1513 | € 1540 | € 1568 | € 1590 | € 1619 | € 1644 | € 1670 | € 1693 | € 1720 | € 1774 | € 1799 | | | | | |
| € 1460 | € 1486 | € 1515 | € 1540 | € 1564 | € 1595 | € 1619 | € 1648 | € 1672 | € 1699 | € 1725 | € 1780 | € 1804 | € 1831 | | | | | |
| € 1486 | € 1513 | € 1540 | € 1564 | € 1595 | € 1622 | € 1648 | € 1676 | € 1702 | € 1727 | € 1781 | € 1807 | € 1833 | € 1861 | | | | | |
| € 1513 | € 1537 | € 1564 | € 1590 | € 1622 | € 1651 | € 1676 | € 1703 | € 1729 | € 1785 | € 1809 | € 1835 | € 1861 | € 1892 | | | | | |
| € 1537 | € 1563 | € 1590 | € 1618 | € 1651 | € 1680 | € 1703 | € 1732 | € 1787 | € 1813 | € 1838 | € 1863 | € 1890 | € 1923 | | | | | |

| 2700 | 2800 | 2900 | 3000 | 3100 | 3200 | 3300 | 3400 | 3500 | 3600 | 3700 | 3800 | 3900 | 4000 | 4100 | 4200 | 4300 | 4400 | 4500 |
|--------|--------|--------|--------|--------|--------|--------|--------|--------|--------|--------|--------|--------|--------|--------|--------|--------|--------|--------|
| € 954 | € 976 | € 996 | € 1020 | € 1043 | € 1063 | € 1084 | € 1105 | € 1124 | € 1146 | € 1165 | € 1189 | € 1211 | € 1229 | € 1250 | € 1273 | € 1292 | € 1313 | € 1332 |
| € 978 | € 1003 | € 1022 | € 1046 | € 1068 | € 1092 | € 1113 | € 1133 | € 1156 | € 1177 | € 1199 | € 1219 | € 1241 | € 1263 | € 1286 | € 1311 | € 1332 | € 1357 | € 1380 |
| € 1003 | € 1025 | € 1051 | € 1071 | € 1097 | € 1116 | € 1141 | € 1162 | € 1183 | € 1208 | € 1229 | € 1250 | € 1275 | € 1295 | € 1315 | € 1335 | € 1357 | € 1377 | € 1397 |
| € 1027 | € 1051 | € 1077 | € 1097 | € 1122 | € 1146 | € 1169 | € 1191 | € 1215 | € 1239 | € 1260 | € 1282 | € 1305 | € 1328 | | | | | |
| € 1051 | € 1077 | € 1102 | € 1124 | € 1151 | € 1175 | € 1196 | € 1219 | € 1243 | € 1265 | € 1292 | € 1315 | € 1339 | € 1361 | | | | | |
| € 1105 | € 1129 | € 1158 | € 1182 | € 1208 | € 1236 | € 1258 | € 1283 | € 1311 | € 1332 | € 1361 | € 1384 | € 1410 | € 1435 | | | | | |
| € 1129 | € 1156 | € 1183 | € 1208 | € 1236 | € 1263 | € 1286 | € 1315 | € 1339 | € 1366 | € 1389 | € 1416 | € 1440 | € 1465 | | | | | |
| € 1156 | € 1182 | € 1211 | € 1236 | € 1260 | € 1290 | € 1315 | € 1344 | € 1367 | € 1395 | € 1420 | € 1446 | € 1471 | € 1497 | | | | | |
| € 1182 | € 1208 | € 1236 | € 1260 | € 1290 | € 1318 | € 1344 | € 1371 | € 1397 | € 1422 | € 1448 | € 1474 | € 1500 | € 1527 | | | | | |
| € 1208 | € 1232 | € 1260 | € 1286 | € 1318 | € 1346 | € 1371 | € 1399 | € 1425 | € 1452 | € 1476 | € 1501 | € 1527 | € 1559 | | | | | |
| € 1232 | € 1258 | € 1286 | € 1313 | € 1346 | € 1376 | € 1399 | € 1428 | € 1454 | € 1480 | € 1504 | € 1530 | € 1556 | € 1589 | | | | | |

These prices apply to standard colours and trend colours. A surcharge of 15% applies for special RAL colours.
If a sunblind is ordered separately from a canopy roof, a flat-rate surcharge of € 200 applies.



NEW

ROOF SUNBLIND

To keep the temperature in a canopy pleasant in the summer, we offer a horizontal sun protection system that can be installed under or above the roof. You can choose between a version with ZIP or without ZIP. In the ZIP version, the fabric is guided by a ZIP technology that results in constant fabric tension and avoids light opening.

The roof sunblinds are custom-made and you can choose between more than 100 fabric colours.

The standard integrated electric drive ensures comfortable operation and can be automated by various control systems. For example, you can choose to operate the screens with your smartphone.

Above the canopy roof

- Maximum width: 600cm
- Unrolls up to: 600cm
- Operation: electric
- Installation possibilities: the screen is mounted above the roof to protect the glass against heat rays
- Somfy actuator
- Pitch of 0° to 60°
- ZIP and non-ZIP

Discover
our range of
colours at
skylux.eu

| ARNEX PS8000 (NON-ZIP) | | | | | | | | | |
|---|--------|--------|--------|--------|--------|--------|--------|--------|--------|
| Gross price with IO actuator / supports / colour / transport / 3m actuator cable included | | | | | | | | | |
| Width (mm) → ↓ Depth/unrolls up to (mm) | 2000 | 2500 | 3000 | 3500 | 4000 | 4500 | 5000 | 5500 | 6000 |
| 1500 | € 3050 | € 3197 | € 3346 | € 3495 | € 3644 | € 3792 | € 3941 | € 4091 | € 4241 |
| 2000 | € 3244 | € 3407 | € 3562 | € 3725 | € 3885 | € 4047 | € 4205 | € 4368 | € 4528 |
| 2500 | € 3335 | € 3511 | € 3684 | € 3857 | € 4032 | € 4203 | € 4377 | € 4551 | € 4725 |
| 3000 | € 3434 | € 3618 | € 3806 | € 3989 | € 4179 | € 4487 | € 4674 | € 4859 | € 5049 |
| 3500 | € 3710 | € 3918 | € 4118 | € 4324 | € 4529 | € 4860 | € 5060 | € 5268 | € 5469 |
| 4000 | € 3782 | € 3999 | € 4214 | € 4427 | € 4646 | € 4988 | € 5204 | € 5418 | € 5637 |
| 4500 | € 3896 | € 4257 | € 4491 | € 4724 | € 4961 | € 5195 | € 5430 | € 5663 | € 5902 |
| 5000 | € 4307 | € 4703 | € 4968 | € 5228 | € 5492 | € 5756 | € 6020 | € 6282 | € 6543 |
| 5500 | € 4471 | € 4892 | € 5177 | € 5459 | € 5745 | € 6026 | € 6311 | € 6592 | € 6877 |
| 6000 | € 4706 | € 5159 | € 5469 | € 5779 | € 6089 | € 6399 | € 6708 | € 7017 | € 7327 |

| ARNEX PS8000 (ZIP) | | | | | | | | | |
|---|--------|--------|--------|--------|--------|--------|--------|--------|--------|
| Gross price with IO actuator / supports / colour / transport / 3m actuator cable included | | | | | | | | | |
| Width (mm) → ↓ Depth/unrolls up to (mm) | 2000 | 2500 | 3000 | 3500 | 4000 | 4500 | 5000 | 5500 | 6000 |
| 1500 | € 3249 | € 3397 | € 3546 | € 3694 | € 3843 | € 3991 | € 4140 | € 4291 | € 4441 |
| 2000 | € 3338 | € 3501 | € 3656 | € 3819 | € 3979 | € 4141 | € 4299 | € 4462 | € 4622 |
| 2500 | € 3581 | € 3758 | € 3930 | € 4103 | € 4278 | € 4449 | € 4623 | € 4798 | € 4972 |
| 3000 | € 3704 | € 3887 | € 4076 | € 4259 | € 4448 | € 4757 | € 4944 | € 5129 | € 5319 |
| 3500 | € 4003 | € 4211 | € 4411 | € 4617 | € 4822 | € 5153 | € 5353 | € 5561 | € 5762 |
| 4000 | € 4099 | € 4315 | € 4531 | € 4744 | € 4962 | € 5305 | € 5521 | € 5735 | € 5954 |
| 4500 | € 4365 | € 4726 | € 4960 | € 5193 | € 5430 | € 5664 | € 5899 | € 6132 | € 6371 |
| 5000 | € 4671 | € 5067 | € 5331 | € 5592 | € 5856 | € 6120 | € 6383 | € 6646 | € 6907 |
| 5500 | € 4988 | € 5408 | € 5693 | € 5975 | € 6261 | € 6542 | € 6827 | € 7108 | € 7393 |
| 6000 | € 5246 | € 5699 | € 6008 | € 6318 | € 6629 | € 6939 | € 7248 | € 7556 | € 7866 |

These prices apply to standard colours and trend colours. A surcharge of 15% applies for special RAL colours. If a sunblind is ordered separately from a canopy roof, a flat-rate surcharge of € 200 applies.

ARNEX 8000 - Installation adapters

| | | |
|---------------------------------|---|--------------|
| Support PS806-2 | Arnex 8000 with ZIP, flat installation | No surcharge |
| Support PS816-1 + PS812 | Arnex 8000 with ZIP, flat installation with finishing profile | No surcharge |
| Support PS815-1 | Arnex 8000 without/with ZIP, installation in frame | No surcharge |
| Support PS826-1/58 & PS828-1/58 | Arnex 8000 without ZIP, small casing, installation supports | No surcharge |
| Support PS826-1/68 & PS828-1/68 | Arnex 8000 without ZIP, small casing, installation supports | No surcharge |
| Support PS826-1/68 | Arnex 8000 without ZIP, small casing, installation supports | No surcharge |

| Adapter set PS806-2/20 | | Adapter set PS806-2/45 | | Adapter set PS806-2/100 | |
|--|-------|---|-------|--|-------|
| Arnex 8000 with ZIP, installation on a 20mm foot | | Arnex 8000 with ZIP, installation on wall-supported and freestanding Climax/Climalux/Panorama/Horizon | | Arnex 8000 without ZIP, installation on wall-supported and freestanding Climax/Climalux/Panorama/Horizon | |
| Depth (mm) | Price | Depth (mm) | Price | Depth (mm) | Price |
| 1001-2000 | € 36 | 1001-2000 | € 69 | 1000-1500 | € 58 |
| 2001-3000 | € 40 | 2001-3000 | € 84 | 1500-2499 | € 76 |
| 3001-4000 | € 45 | 3001-4000 | € 100 | 3000-4499 | € 94 |
| 4001-5000 | € 50 | 4001-5000 | € 116 | 4500-6000 | € 112 |
| 5001-6000 | € 54 | 5001-6000 | € 132 | | |

Under the canopy roof

- Maximum width: 600cm
- Unrolls up to: 450cm
- Operation: electric
- Installation possibilities: the screen is mounted under the glass and is protected from rain
- Somfy actuator
- Pitch of 0° to 25°
- ZIP

ARNEX PS2500 (always ZIP)

Gross price with IO actuator / supports / colour / transport / 3m actuator cable included

| Width (mm) → ↓ Depth/unrolls up to (mm) | 2000 | 2500 | 3000 | 3500 | 4000 | 4500 | 5000 | 5500 | 6000 |
|--|--------|--------|--------|--------|--------|--------|--------|--------|--------|
| 1000 | € 2581 | € 2715 | € 2849 | € 2977 | € 3111 | € 3247 | € 3377 | € 3512 | € 3644 |
| 1500 | € 2676 | € 2825 | € 2969 | € 3118 | € 3263 | € 3413 | € 3561 | € 3707 | € 3854 |
| 2000 | € 2775 | € 2931 | € 3097 | € 3256 | € 3416 | € 3586 | € 3746 | € 3904 | € 4067 |
| 2500 | € 2891 | € 3073 | € 3249 | € 3422 | € 3603 | € 3777 | € 3962 | € 4135 | € 4312 |
| 3000 | € 2991 | € 3182 | € 3373 | € 3565 | € 3755 | € 3947 | € 4138 | € 4336 | € 4524 |
| 3500 | € 3087 | € 3291 | € 3498 | € 3702 | € 3912 | € 4117 | € 4323 | € 4528 | € 4737 |
| 4000 | € 3211 | € 3427 | € 3650 | € 3869 | € 4088 | € 4316 | € 4535 | € 4759 | € 4974 |
| 4500 | € 3303 | € 3544 | € 3773 | € 4011 | € 4241 | € 4478 | € 4723 | € 4954 | € 5190 |

These prices apply to standard colours and trend colours. A surcharge of 15% applies for special RAL colours. If a sunblind is ordered separately from a canopy roof, a flat-rate surcharge of € 200 applies.

ARNEX 2500 - Installation adapters

| Standard | No surcharge | | | Adapter set L-supports | Installation against the side of the rafters | | |
|------------------------------|---|-----------|-----------|------------------------------|--|-----------|-----------|
| Adapter set Climaled | Installation in combination with Climaled | | | Adapter set L-supports | Installation against the side of the rafters | | |
| | 0 | 1 | 2 | | 0 | 3 | 4 |
| Width (mm) → ↓ Depth (mm) | 1000-2000 | 2001-4000 | 4001-6000 | Width (mm) → ↓ Depth (mm) | 1000-2000 | 2001-4000 | 4001-6000 |
| 1500-2000 | € 72 | € 76 | € 81 | 1500-2000 | € 78 | € 117 | € 131 |
| 2000-2999 | € 82 | € 87 | € 91 | 2000-2999 | € 96 | € 136 | € 149 |
| 3000-3999 | € 92 | € 97 | € 101 | 3000-3999 | € 114 | € 154 | € 167 |
| 4000-4500 | € 102 | € 107 | € 112 | 4000-4500 | € 132 | € 172 | € 185 |





CLIMALED

Spots

This lighting profile with pre-mounted LED spotlights provides the ideal lighting for your veranda or canopy and is mounted discreetly under the rafters. The long-lasting LED spotlights produce a warm white light that can be dimmed using the remote control, enabling you to create the required lighting ambience, from soft atmospheric to bright functional lighting. These pre-cabled lighting profiles (3 spotlights per profile) can be installed very easily and quickly.

A lighting set Climalux spots includes:

- two or more colour coated aluminium profiles with 3 built-in LED spots
- a transformer 230/24V DC 30W or 60W depending on the number of spots
- a remote control
- the wiring between the spots and the transformer
- the assembly accessories
- You can choose between warm light (2800K) or cold light (4000K). Cold light available from June 2024.

| Depth D (mm) | Colour | Number of lighting profiles | | | | | | |
|--|--------------|-----------------------------|-----------|-----------|-----------|-----------|-----------|-----------|
| | | 2 | 3 | 4 | 5 | 6 | 7 | 8 |
| 2500-4000 ($\alpha_{max} = 20^\circ$) | Standard | € 692.43 | € 931.63 | € 1201.05 | € 1440.25 | € 1679.45 | € 2132.68 | € 2402.11 |
| | Special RAL* | € 730.30 | € 988.42 | € 1276.78 | € 1534.91 | € 1793.04 | € 2265.21 | € 2553.56 |
| 4001-5000 ($\alpha_{max} = 20^\circ$) | Standard | € 739.54 | € 1002.28 | € 1295.26 | € 1558.01 | € 1820.76 | € 2297.54 | € 2590.52 |
| | Special RAL* | € 784.46 | € 1069.66 | € 1385.10 | € 1670.31 | € 1955.52 | € 2454.76 | € 2770.20 |
| 5001-6000 ($\alpha_{max} = 20^\circ$) | Standard | € 771.83 | € 1050.73 | € 1359.86 | € 1638.76 | € 1917.65 | € 2410.59 | € 2719.72 |
| | Special RAL* | € 821.59 | € 1125.37 | € 1459.38 | € 1763.15 | € 2066.93 | € 2584.74 | € 2918.75 |

The standard colours are white (RAL 9010) and anthracite structured (RAL 7016 ST) and the trend RAL colours of Climalux

* For orders without a patio roof, there is a surcharge of € 200 for the colour change

Our cable ducts offer the neat option to hide the Climalux cables. Providing a cable duct for your Skylux patio roof creates an added value, especially to facilitate the installation of Climalux if your customer wishes to have LED lighting afterwards.

The cable duct is available for Climalux/Climalux Horizon/Climax and Climax Panorama.

Please note: the roof slope is limited (max. 20°) in case of a wall-mounted Climax or Climax Panorama with cable duct.



Stripes

An LED light strip can also be integrated into the gutter. This LED lighting emits a beautiful, soft and pleasant warm white light.

A lighting set Climalux strip includes:

- one colour coated aluminium profile GDGL (Climalux)
- one LED strip 24V (120 LEDs /m)
- a transformer 230/24V DC 30W or 60W
- the wiring (6m) between the LED strip and the transformer
- the assembly accessories

| | Length (m) | 4 | 5 | 6 | 7 |
|-----------------|--------------|----------|----------|----------|----------|
| Climalux | Standard | € 238.18 | € 319.79 | € 359.28 | € 398.68 |
| | Special RAL* | € 242.14 | € 324.74 | € 365.22 | € 405.61 |
| Climax Panorama | Standard | € 203.90 | € 278.92 | € 311.82 | € 344.63 |
| | Special RAL* | € 203.90 | € 278.92 | € 311.82 | € 344.63 |

The standard colours are white (RAL 9010) and anthracite structured (RAL 7016 ST) and the trend RAL colours of Climalux
Additional cost for model with remote control, receiver and dimmer: + € 293.53

* For orders without a patio roof, there is a surcharge of € 200 for the colour change

NON-SELF-SUPPORTING PROFILE SYSTEMS

PERGOLUX

Profiles for a timber supporting structure

Any construction with multi-walled plastic sheets requires non-self-supporting aluminium profiles. These profiles must be mounted on timber or steel rafters before fixing the sheets into them. The multi-walled sheets are not screwed. Heat can cause the multi-walled plastics sheets to expand and can cause cracks. The aluminium profiles allow the sheets to move enough to prevent these cracks. We offer different types of profiles to click or to drill in plastic material or in aluminium. The choice is yours!



The Pergolux D-series can be assembled with “shim tape” or as a full set. Thanks to the high-quality profiles, your conservatory roof will have an elegant design.



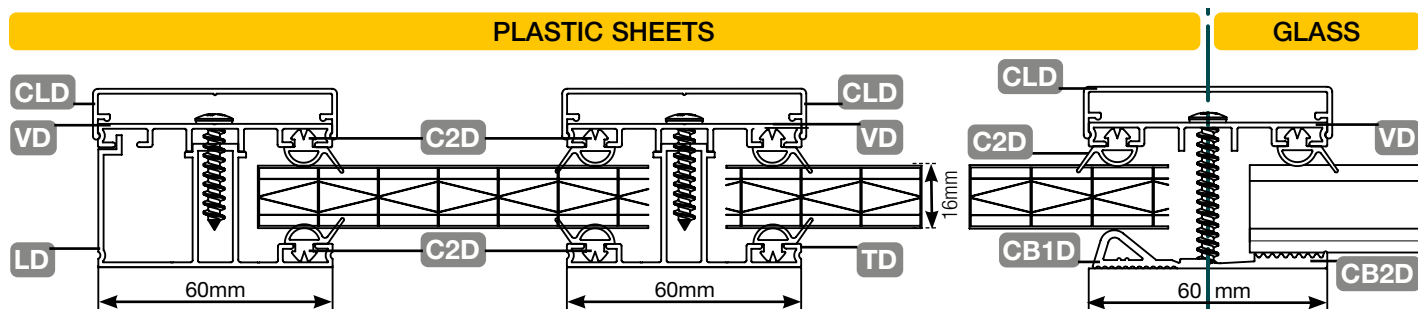

Price list Pergolux D-series

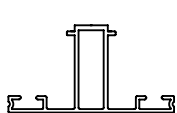
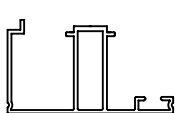
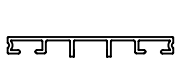
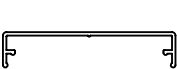



| GROUP | TYPE | DESCRIPTION | LENGTH | ARTICLE | UNIT | PRICE / UNIT | |
|---|------|----------------------------|--------|---------|------|--------------|---------|
| WALL PROFILE | | | M | O | W | O | W |
|  | MD | Wall profile (122mm width) | 4.1 | 25125 | | m | € 13.00 |
| | | | 5.1 | 25649 | | m | € 13.00 |
| | | | 6.1 | 25126 | | m | € 13.00 |
| | | | 7.1 | 25650 | | m | € 13.00 |

| GROUP | TYPE | DESCRIPTION | LENGTH | ARTICLE | UNIT | PRICE / UNIT | | |
|---|------|---------------------------------------|--------|---------|--------|--------------|---------|--------|
| RAFTER AND SIDE RAFTER | | | M | O | W | O | W | |
|  | TD | Rafter TD | 2.5 | 30348 | | m | € 10.85 | |
| | | | 3 | 29457 | | m | € 10.85 | |
| | | | 3.5 | 29458 | | m | € 10.85 | |
| | | | 4 | 25101 | | m | € 10.85 | |
| | | | 5 | 25102 | | m | € 10.85 | |
| | | | 6 | 25103 | | m | € 10.85 | |
| | | | 7 | 25104 | | m | € 10.85 | |
|  | LD | Side rafter LD | 2.5 | 30347 | | m | € 11.65 | |
| | | | 3 | 29455 | | m | € 11.65 | |
| | | | 3.5 | 29456 | | m | € 11.65 | |
| | | | 4 | 25105 | | m | € 11.65 | |
| | | | 5 | 25106 | | m | € 11.65 | |
| | | | 6 | 25107 | | m | € 11.65 | |
| | | | 7 | 25108 | | m | € 11.65 | |
|  | VD | Connecting profile VD | 2.5 | 32327 | | m | € 6.39 | |
| | | | 3 | 29459 | | m | € 6.39 | |
| | | | 3.5 | 29460 | | m | € 6.39 | |
| | | | 4 | 25097 | | m | € 6.39 | |
| | | | 5 | 25098 | | m | € 6.39 | |
| | | | 6 | 25099 | | m | € 6.39 | |
| | | | 7 | 25100 | | m | € 6.39 | |
|  | CLD | Clip cover for rafter and side rafter | 4 | 25113 | 25121* | m | € 5.42 | € 8.40 |
| | | | 5 | 25114 | 25122* | m | € 5.42 | € 8.40 |
| | | | 6 | 25115 | 25123* | m | € 5.42 | € 8.40 |
| | | | 7 | 25120 | 25124* | m | € 5.42 | € 8.40 |
|  | Y16D | Filling profile for rafter TD | 3 | 44709 | | m | € 5.22 | |
| | | | 3.5 | 44710 | | m | € 5.22 | |
| | | | 4 | 44711 | | m | € 5.22 | |
| | | | 7 | 44712 | | m | € 5.22 | |

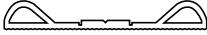
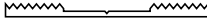
FINISH | 0 = mill finished aluminium / W = white or RAL 9010
 * Delivery time on request

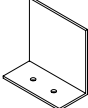
| GROUP | TYPE | DESCRIPTION | LENGTH | ARTICLE | | UNIT | PRICE / UNIT | |
|---|------|---|----------|----------|----------|------|--------------|----------|
| RUBBER | | | M | 0 | W | | 0 | W |
|  | C1D | Sealing for wall profile coex white | 100 * | | 25130 | m | | € 3.45 |
|  | C2D | Sealing for wall profile coex white for DT, DL and DV | 200 * | | 25131 | m | | € 1.79 |
|  | CB1D | Soft rubber strip coex white | 50 * | | 25133 | m | | € 5.22 |
|  | CB2D | Ribbed inferior strip - black | 50 * | 25134 | | m | € 3.59 | |

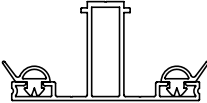
| GROUP | TYPE | DESCRIPTION | LENGTH | ARTICLE | | UNIT | PRICE / UNIT | |
|--|------|--------------------------------------|--------|----------|--|------|--------------|--|
| STOP | | | | 0 | | | 0 | |
|  | SD | L-shaped stop for aluminium profiles | pc | 46546 | | pc | € 3.22 | |











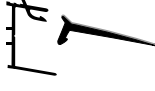
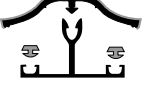

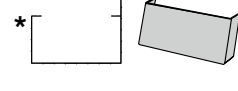

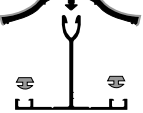
| GROUP | TYPE | DESCRIPTION | LENGTH | ARTICLE | | UNIT | PRICE / UNIT | |
|---|------|---|----------|----------|----------|------|--------------|----------|
| PROFILES WITH PRE-MOUNTED RUBBER | | | M | 0 | W | | 0 | W |
|  | ETD | Rafter TD with 2 x rubber C2D | 2.5 | 32329 | | m | € 15.43 | |
| | | | 3 | 29591 | | m | € 15.43 | |
| | | | 3.5 | 29592 | | m | € 15.43 | |
| | | | 4 | 25138 | | m | € 15.43 | |
| | | | 5 | 25171 | | m | € 15.43 | |
| | | | 6 | 25172 | | m | € 15.43 | |
| | | | 7 | 25173 | | m | € 15.43 | |
|  | ELD | Side rafter LD with rubber C2D | 2.5 | 32331 | | m | € 13.94 | |
| | | | 3 | 29593 | | m | € 13.94 | |
| | | | 3.5 | 29594 | | m | € 13.94 | |
| | | | 4 | 25174 | | m | € 13.94 | |
| | | | 5 | 25175 | | m | € 13.94 | |
| | | | 6 | 25176 | | m | € 13.94 | |
| | | | 7 | 25177 | | m | € 13.94 | |
|  | EVD | Connecting profile VD with 2 x rubber C2D | 2.5 | 32333 | | m | € 10.97 | |
| | | | 3 | 32334 | | m | € 10.97 | |
| | | | 3.5 | 32335 | | m | € 10.97 | |
| | | | 4 | 32336 | | m | € 10.97 | |
| | | | 5 | 32338 | | m | € 10.97 | |
| | | | 6 | 32339 | | m | € 10.97 | |
| | | | 7 | 32340 | | m | € 10.97 | |

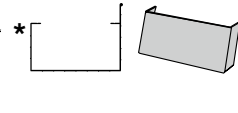
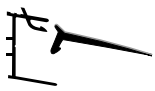
FINISH | 0 = mill finished aluminium or rubber black / W = white or RAL 9010
 * Length per roll, the rubbers are available in multiple profile lengths

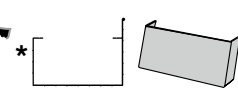
Standard series

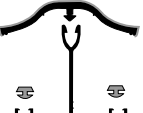
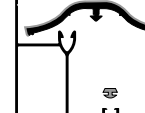
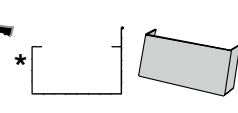
| | | |
|---------------------------------|---|--|
| <p>ALU</p> | <p>ALU: System with aluminium profiles and standard grey coex rubber</p> | |
| <p>COLOR</p> | <p>COLOR: System with powder coated aluminium profiles (white RAL 9010) and white coex rubber</p> | |
| <p>COLOR-THERM</p> | <p>COLOR-THERM: System with thermal break and powder coated aluminium clip (white RAL 9010 or anthracite RAL 7016 ST)</p> | |
| <p>COLOR-THERM GLASS</p> | <p>COLOR-THERM GLASS: System with thermal break and screwable aluminium clip (white RAL 9010, anthracite RAL 7016 ST or any other RAL colour of your choice)</p> | |

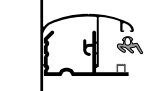
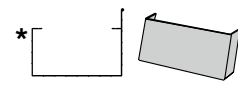
CA = sheet width + 22mm

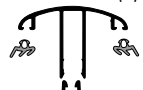
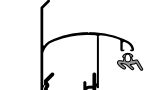
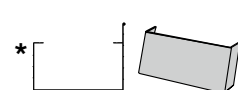
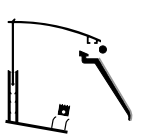
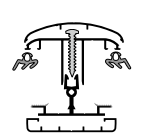
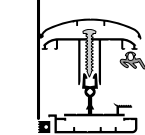
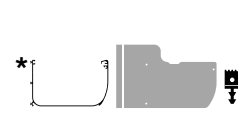
| | WALL | RAFTER | SIDE RAFTER | GUTTER | ACCESSORIES | | | | | |
|-------------|--|--|---|--|-------------|------|------|-------|----|-------------------|
| 16mm | M16 + C4CX  | T16.1 + C2CX + C3 (x2)  | L16 + C3 + C4CX  | G120A + G120AS + C6  | S16C | BT16 | BB16 | U16P | BM | ALU |
| 32mm | M32T + M32B + C4CX  | T32.1 + C2CX + C3 (x2)  | L32.1 + C4CX + C3  | G120A + G120AS + C6  | S32C | BT32 | BB32 | U32P | BM | |
| 16mm | M16 + C4CX  | T16.2 + C2CX + C3 (x2)  | LT16 + C3 + C2CX  | G120A + G120AS + C6  | S16C | BT16 | BB16 | U16 | BM | COLOR |
| 32mm | M32T + M32B + C4CX  | T32.1 + C2CX + C3 (x2)  | LT32 + C2CX + C3  | G120A + G120AS + C6  | S32C | BT32 | BB32 | U32A | BM | |
| 16mm | CLM + MP + C1CX + C12  | T16P + CL16 + C8 (x2)  | CLL + LP + C8  | G120A + G120AS + C6  | S16.3 | BT16 | BB16 | U16 | | COLOR-THERM |
| 32mm | CLM + MP + C1CX + C12  | T16P + CL32 + C8 (x2)  | CLL + LP + C8  | G120A + G120AS + C6  | S32.3 | BT32 | BB32 | U32 | | |
| 8mm to 34mm | CLM + MP + C1CX + C12 + C31  | TPH + TPG + CLSB + CLST + C8 (x2) + screw  | TPHL + TPGL + CLSB + CLSL + C31 + C8 + screw  | G + GAS1 + C13 + C6  | S38.3 | L432 | Y16P | C11CX | | COLOR-THERM GLASS |

* to combine with gutter top piece GR

Price list Pergolux



1. Profiles

| GROUP | TYPE | DESCRIPTION | LENGTH | ARTICLE NUMBER | | | UN. | PRICE / UNIT | | |
|-------|---------------|--|--------|----------------|--------|-------|-----|--------------|---------|---------|
| M | WALL PROFILES | | M | O | W 9010 | B | RAL | O | W/B | |
| | MP | PVC wall profile with soft supporting lips for sheets 16, 25 and 32mm for use with CLM profile | 3.5 | | 17756 | 17689 | | m | - | € 11.47 |
| | | | 5 | | 17757 | 17754 | | m | | |
| | | | 7 | | 17758 | 17755 | | m | | |
| | M16 | Alu wall profile without lip for 16mm sheets | 3.5 | 13257 | 15468 | | | m | € 13.19 | € 15.06 |
| | | | 5 | 13258 | 15469 | | | m | | |
| | | | 7 | 13259 | 15470 | | | m | | |
| | M32T | Alu wall profile "top" for sheets > 20mm | 3.5 | 13268 | 13501 | | | m | € 11.87 | € 14.31 |
| | | | 5 | 13269 | 13502 | | | m | | |
| | | | 7 | 13270 | 13503 | | | m | | |
| | M32B | Alu wall profile "bottom" for sheets > 20mm | 3.5 | 13277 | | | | m | € 7.90 | - |
| | | | 5 | 13280 | | | | m | | |
| | | | 7 | 13281 | | | | m | | |

| GROUP | TYPE | DESCRIPTION | LENGTH | ARTICLE NUMBER | | | UN. | PRICE / UNIT | | |
|-------|---------|--|--------|----------------|--------|-------|-----|--------------|---------|---------|
| T | RAFTERS | | M | O | W 9010 | B | RAL | O | W/B | |
| | T16P | PVC rafter with soft bulbs Not for glass | 2.5 | | 13202 | 13209 | | m | - | € 10.02 |
| | | | 3 | | 13203 | 13210 | | m | | |
| | | | 3.5 | | 13204 | 13211 | | m | | |
| | | | 4 | | 13205 | 13212 | | m | | |
| | | | 5 | | 15588 | 15587 | | m | | |
| | | | 6 | | 13206 | 13213 | | m | | |
| | | | 7 | | 13207 | 13214 | | m | | |
| | T16.1 | Alu rafter for 16mm sheets | 2.5 | 13170 | | | | m | € 8.87 | - |
| | | | 3 | 13171 | | | | m | | |
| | | | 3.5 | 13172 | | | | m | | |
| | | | 4 | 13173 | | | | m | | |
| | | | 5 | 14537 | | | | m | | |
| | | | 6 | 13174 | | | | m | | |
| | | | 7 | 13175 | | | | m | | |
| | T16.2 | Alu rafter for 16mm sheets (self supporting till 80cm) | 2.5 | 13178 | 13185 | | | m | € 11.44 | € 14.61 |
| | | | 3 | 13179 | 13186 | | | m | | |
| | | | 3.5 | 13180 | 13187 | | | m | | |
| | | | 4 | 13181 | 13188 | | | m | | |
| | | | 5 | 14538 | 14606 | | | m | | |
| | | | 6 | 13182 | 13189 | | | m | | |
| | | | 7 | 13183 | 13190 | | | m | | |
| | T32.1 | Alu rafter for 32mm sheets (self supporting till 100cm) | 2.5 | 14223 | 14392 | | | m | € 9.63 | € 14.58 |
| | | | 3 | 14224 | 14393 | | | m | | |
| | | | 3.5 | 14225 | 14394 | | | m | | |
| | | | 4 | 14226 | 14395 | | | m | | |
| | | | 5 | 14227 | 14396 | | | m | | |
| | | | 6 | 14228 | 14397 | | | m | | |
| | | | 7 | 14229 | 14398 | | | m | | |
| | TP | PVC thermal rafter profile for sheets | 3.2 | | 21278 | | | m | - | € 10.48 |
| | | | 3.7 | | 21279 | | | m | | |
| | | | 4.2 | | 21280 | | | m | | |
| | | | 5.2 | | 24468 | | | m | | |
| | | | 6.2 | | 21281 | | | m | | |

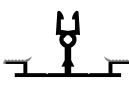
FINISH | O : mill finished aluminium / W : white or RAL 9010 / B : brown in stock
RAL colour cost possible for order Color-Therm Glass : +15% on price of white and with start up cost of + € 200 net

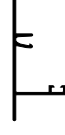
| GROUP | TYPE | DESCRIPTION | LENGTH | ARTICLE NUMBER | | | | UN. | PRICE / UNIT | |
|---|---------|--------------------------------------|--------|----------------|-----------|---|-------|-----|--------------|---------|
| T | RAFTERS | | M | O | W 9010 | B | RAL | | O | W/B |
|  | TPG | PVC thermal rafter profile for glass | 4.2 | | 25055 | | | m | - | € 10.48 |
| | | | 5.2 | | 25056 | | | m | | |
| | | | 6.2 | | 25057 | | | m | | |
| | | | 7.2 | | 25058 | | | m | | |
| | TPH | Alu support profile for TP - TPG | 2.6 | 22580 | 22585 | | 24414 | m | € 6.53 | € 9.87 |
| | | | 3.1 | 22581 | 22586 | | 24337 | m | | |
| | | | 3.6 | 22582 | 22587 | | 24415 | m | | |
| | | | 4.1 | 22583 | 22588 | | 24416 | m | | |
| | | | 5.1 | 25066 | 25067 | | 25072 | m | | |
| | | | 6.1 | 22584 | 22589 | | 24417 | m | | |

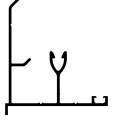
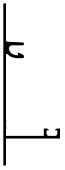
| GROUP | TYPE | DESCRIPTION | LENGTH | ARTICLE NUMBER | | | | UN. | PRICE / UNIT | |
|---|--------------|--|--------|----------------|-----------|-------|-------|-----|--------------|---------|
| L | SIDE RAFTERS | | M | O | W 9010 | B | RAL | | O | W/B |
|  | LP | PVC side profile with soft bulb for sheets 16, 25 and 32mm Use with CLL and C8 | 2.5 | | 17767 | 17759 | | m | - | € 12.34 |
| | | | 3 | | 17768 | 17760 | | m | | |
| | | | 3.5 | | 17769 | 17761 | | m | | |
| | | | 4 | | 17770 | 17762 | | m | | |
| | | | 5 | | 17771 | 17763 | | m | | |
| | | | 6 | | 17772 | 17764 | | m | | |
| | | | 7 | | 17773 | 17765 | | m | | |
|  | L16 | Alu side profile for 16mm sheets | 2.5 | 13221 | | | | m | € 9.32 | - |
| | | | 3 | 13222 | | | | m | | |
| | | | 3.5 | 13223 | | | | m | | |
| | | | 4 | 13224 | | | | m | | |
| | | | 5 | 14624 | | | | m | | |
| | | | 6 | 13225 | | | | m | | |
| | | | 7 | 13226 | | | | m | | |
|  | L16P | Alu side finishing profile for 16, 25, 32mm sheets | 2.54 | 16718 | 15478 | | 21231 | m | € 11.87 | € 13.64 |
| | | | 3.04 | 16719 | 15479 | | 21232 | m | | |
| | | | 3.54 | 16720 | 15480 | | 21233 | m | | |
| | | | 4.04 | 16721 | 15481 | | 21234 | m | | |
| | | | 5.04 | 16722 | 15482 | | 21235 | m | | |
| | | | 7.04 | 16723 | 15483 | | 21237 | m | | |
|  | LT16 | Alu side profile for 16mm sheets | 2.5 | 15490 | 15534 | | | m | € 13.53 | € 16.92 |
| | | | 3 | 15491 | 15535 | | | m | | |
| | | | 3.5 | 15492 | 15536 | | | m | | |
| | | | 4 | 15493 | 15537 | | | m | | |
| | | | 5 | 15495 | 15538 | | | m | | |
| | | | 6 | 15496 | 15539 | | | m | | |
| | | | 7 | 15497 | 15540 | | | m | | |
|  | L32.1 | Alu side profile for sheets >= 25mm | 2.5 | 14230 | | | | m | € 10.77 | € 16.02 |
| | | | 3 | 14231 | | | | m | | |
| | | | 3.5 | 14232 | | | | m | | |
| | | | 4 | 14233 | | | | m | | |
| | | | 5 | 14234 | | | | m | | |
| | | | 6 | 14235 | 14456 | | | m | | |
| | | | 7 | 14238 | 14457 | | | m | | |

FINISH | O : mill finished aluminium / W : white or RAL 9010 / B : brown in stock
RAL colour cost possible for order Color-Therm Glass : +15% on price of white and with start up cost of + € 200 net



| GROUP | TYPE | DESCRIPTION | LENGTH | ARTICLE NUMBER | | | UN. | PRICE / UNIT | | |
|-------|--------------|------------------------------------|--------|----------------|---|-----|-------|--------------|---------|---------|
| L | SIDE RAFTERS | | M | O | W 9010 | | RAL | O | W | |
| | LT32 | Alu side profile for sheets > 25mm | 2.5 | 15548 | 15556 | | | m | € 16.79 | € 18.58 |
| | | | 3 | 15549 | 15557 | | | m | | |
| | | | 3.5 | 15550 | 15558 | | | m | | |
| | | | 4 | 15551 | 15569 | | | m | | |
| | | | 5 | 15552 | 15570 | | | m | | |
| | | | 7 | 15555 | 15572 | | | m | | |
| | | | | TPGL | PVC thermal side rafter profile for glass | 4.2 | | 25059 | | |
| 5.2 | | 25060 | | | | | | m | | |
| 6.2 | | 25061 | | | | | | m | | |
| 7.2 | | 25062 | | | | | | m | | |
| | TPHL | Alu side support for TPGL | 4.1 | 24992 | 25004 | | 25008 | m | € 6.53 | € 9.87 |
| | | | 5.1 | 24993 | 25005 | | 25009 | m | | |
| | | | 6.1 | 24994 | 25006 | | 25010 | m | | |
| | | | 7.1 | 24995 | 25007 | | 25011 | m | | |







| GROUP | TYPE | DESCRIPTION | LENGTH | ARTICLE NUMBER | | | UN. | PRICE / UNIT | | |
|-------|-----------------|---|--------|----------------|-------------------------------------|------|-------|--------------|--------|--------|
| Y | RISING PROFILES | | M | O | W 9010 | | RAL | O | W | |
| | Y10 | Alu adapter profile for 10mm sheets. Slides in the profiles in place of rubber C3 of C8 | 6.54 | 18324 | 18403 | | 21283 | m | € 3.14 | € 5.69 |
| | | | | Y32 | Alu adapter profile for 32mm sheets | 7.04 | 13314 | | | m |

2. Rubbers and clip profiles

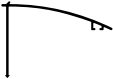
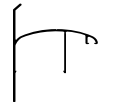
| GROUP | TYPE | DESCRIPTION | LENGTH | ARTICLE NUMBER | | | UN. | PRICE / UNIT | |
|-------|---------|--|--------|----------------|-------|-------|-----|--------------|--------|
| C | RUBBERS | | M | WHITE | GREY | BLACK | | | |
| | C1CX | Coex rubber anti-elastic for CLM | 35 | 17701 | 17703 | | | m | € 4.75 |
| | C2CX | Coex rubber anti-elastic for profiles T16P - T16.1 - T16.2 - T32.1 - TP - TPG - TPGL - Y25 - Y32 - LT16 - LT32 | 2 x 24 | 18316 | 18315 | | | m | € 6.19 |
| | | | 35 | 15471 | 17697 | | | m | |
| | | | 50 | 15472 | 17698 | | | m | |
| | C4CX | Coex rubber anti-elastic for wall profile M16 - M32T and side profile L16 - L32.1 | 2 x 18 | 18361 | 18318 | | | m | € 5.70 |
| | | | 35 | 15473 | 17699 | | | m | |
| | | | 75 | 15475 | 17700 | | | m | |
| | C12 | Support thread for C1CX | 200 | | 23875 | | | m | € 0.78 |
| | C3 | Supporting rubber for sheets for T16.1 - T16.2 - T32.1 - L16 - L32.1 - LT16 - LT32 | 200 | | 13319 | | | m | € 1.11 |
| | C13 | Supporting rubber for glass | 200 | | 24328 | | | m | € 4.87 |
| | C6 | Sealing rubber between wooden frame at gutter side and sheets or glass | 150 | | 13326 | | | m | € 5.54 |
| | C7 | Rubber black for WB -10mm | 100 | | | 65895 | | m | € 2.79 |
| | C8 | Sealing rubber for alu clips CL16/32, CLL, CLSB | 300 | | 13328 | | | m | € 1.48 |
| | | | 300 | | | 23803 | | m | € 1.48 |
| | CY10 | Rubber adapter for alu clips CL16 / CL32 / CLL / CLSB / T32.1 / L16 / LT16 / L32 / LT32 | 50 | | 29509 | | | m | € 4.20 |
| | C11CX | Sealing rubber white-black for gutter G Use with Y16P | 50 | 21557 | | | | m | € 9.46 |
| | C17 | Rubber black for WC -10mm | 500 | | | 72045 | | m | € 2.87 |

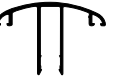
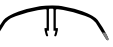
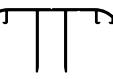

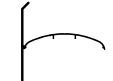







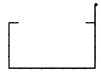
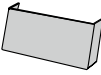

FINISH | O : mill finished aluminium / W : white or RAL 9010 in stock
RAL colour cost possible for order Color-Therm Glass : +15% on price of white and with start up cost of + € 200 net

| GROUP | TYPE | DESCRIPTION | LENGTH | ARTICLE NUMBER | | | UN. | PRICE / UNIT |
|---|----------------|--|----------|----------------|-------------|--------------|-----|--------------|
|    | RUBBERS | | M | WHITE | GREY | BLACK | | |
| | C18 | Rubber black for WC -16mm | 50 | | | 72044 | m | € 2.45 |
| | C27 | Rubber black for WU / WH -10mm | 50 | | | 72135 | m | € 3.72 |
| | C31 | Supporting rubber for glass with MP and TPHL | 200 | | 28805 | | m | € 4.87 |
| | VRM9053.07 | rubber profile for sheets 32mm | 50 | | | 103548 | m | € 6.07 |

| GROUP | TYPE | DESCRIPTION | LENGTH | ARTICLE NUMBER | | | | UN. | PRICE / UNIT | | |
|---|----------------------|--|--|--|--|--|--|-----|--------------------------------------|------------|---------|
|            | CLIP PROFILES | | M | 0 | W 9010 | A 7016ST | RAL | | 0 | W/A | |
| | CLM | Alu clips profile for wall profile with 16, 25 and 32mm sheets For use with MP, C1CX and C12 | 3.5 5 7 | 17707 17710 17711 | 17724 17725 17726 | 54973 54974 54975 | 24375 24376 24378 | | m m m | € 16.45 | € 18.91 |
| | CLL | Alu clip profile for side finish with 16, 25 and 32mm sheets Use with LP, TP, TPGL and rubber C8 or CY10 | 2.04 2.54 3.04 3.54 4.04 5.04 6.04 7.04 | 17713 17714 17715 17716 17717 17718 17712 17719 | 17740 17741 17742 17743 17744 17745 17728 17746 | 31354 31355 31356 31357 31358 31359 31360 31361 | 21174 21175 21176 21177 21178 21179 21180 21181 | | m m m m m m m m | € 20.72 | € 23.82 |
| | CL16 | Alu clip profile, use with C8 or CY10 on T16P - TP - TPG In combination with 16mm sheets | 2.04 2.54 3.04 3.54 4.04 5.04 6.04 7.04 | 13329 13330 13331 13332 13333 | 13336 13337 13338 13339 13340 | 31234 31235 31236 31237 31238 | 16063 16064 16065 16066 16067 | | m m m m m m m m | € 11.71 | € 13.47 |
| | CL32 | Alu clip profile, use with C8 or CY10 on T16P - TP - TPG In combination with 25 and 32mm sheets | 2.04 2.54 3.04 3.54 4.04 5.04 6.04 7.04 | 13350 13351 13154 13155 13156 14372 13157 13158 | 13352 13353 13159 13160 13161 14373 13162 13163 | 31242 31243 31244 31245 31246 31247 31248 31249 | 16073 16074 16075 16076 16088 16089 16091 16092 | | m m m m m m m m | € 14.89 | € 17.12 |
| | CLPV | PVC shockproof clip with soft sealing borders for T16P - T16.1 - T16.2 - T32.1 - TP - TPG - Y25 - Y32 - LT16 - LT32 length = standard length + 25mm | 2.5 3 3.5 4 5 6 7 | | | | 15608 15636 15611 15613 15614 15615 15616 | | m m m m m m m | - | € 4.73 |
| | CLSB | Screwable clip profile bottom, use with CLST - CLSL and C8 - CY10 | 4.04 5.04 6.04 7.04 | 23914 23915 23916 23917 | | | | | m m m m | € 8.34 | - |
| | CLST | Screwable clip profile top, use with CLSB | 4.04 5.04 6.04 7.04 | 23922 23923 23924 23925 | 23938 23939 23940 23941 | 31251 31252 31253 31254 | 23946 23947 23948 23949 | | m m m m | € 5.95 | € 6.82 |
| | CLSL | Screwable side clip profile, use with CLSB | 4.04 5.04 6.04 7.04 | 25012 25013 25014 25015 | 25024 25025 25026 25027 | 31286 31287 31288 31289 | 25028 25029 25030 25031 | | m m m m | € 18.84 | € 21.66 |
| | GVT | Top profile for glass connector | 2 | 61297 | 61300 | 61298 | 61301 | | m | € 6.11 | € 8.95 |
| | GVB | Bottom profile for glass connector | 2 | 61293 | 61296 | 61294 | 61302 | | m | € 6.73 | € 10.45 |

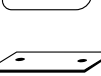
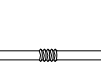
FINISH | 0 : mill-finished aluminium / W : white or RAL 9010 / A : anthracite or RAL 7016 structure in stock
RAL colour cost possible for order Color-Therm Glass : +15% on price of white and with start up cost of + € 200 net

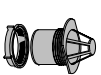
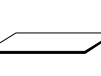
3. Aluminium gutters



| GROUP | TYPE | DESCRIPTION | LENGTH | ARTICLE NUMBER | | | | | UN. | PRICE / UNIT | |
|---|---|---|--------|----------------|--------|-------|-----------|-------|---------|--------------|---------|
| | | | | O | W 9010 | B | A 7016 ST | RAL | | O | W/B/A |
| G |  | G120A Alu gutter G120A | 3.5 | 13283 | 13294 | | 54976 | 21160 | m | € 27.48 | € 34.21 |
| | | | 5 | 13285 | 13295 | | 54977 | 21161 | m | | |
| | | | 7 | 13291 | 13296 | | 54978 | 21162 | m | | |
| |  | G120AS End piece gutter for G120A | pc | 21310 | 13306 | | 47198 | 21588 | pc | € 3.94 | € 9.07 |
| | | | | | | | | | | | |
| |  | GR Raised profile for gutter G120A or G | 3.54 | 17820 | 17828 | | 31343 | 21163 | m | € 21.22 | € 24.42 |
| | | | 5.04 | 17819 | 17830 | | 31344 | 21164 | m | | |
| | | | 7.04 | 17821 | 17831 | | 31345 | 21165 | m | | |
| |  | GRS1 End piece gutter for GR or G120A | pc | 17832 | 17835 | | 47596 | 21598 | pc | € 26.61 | € 32.02 |
| | | | | | | | | | | | |
| |  | GV Set for mechanical gutter connection G120A (2 pcs G120AS, 1 pc GB and 10 stainless screws) | pc | 17955 | | | | | pc | € 21.05 | |
| | | | | | | | | | | | |
| |  | G Alu gutter profile G for Color-Therm Glass | 3.54 | 21385 | 21391 | | 31214 | 21394 | m | € 49.78 | € 57.25 |
| | | | 4.29 | 23388 | 23391 | | 31215 | 23390 | m | | |
| | | | 5.04 | 21386 | 21392 | | 31216 | 21395 | m | | |
| 7.04 | | | 21387 | 21393 | | 31217 | 21396 | m | | | |
| pc | | | 21543 | 21540 | | 31259 | 21544 | pc | € 13.97 | € 16.06 | |
|  | GAS1 End piece gutter for G + GD | | | | | | | | | | |
| | | | | | | | | | | | |
|  | GRS2 End piece gutter for G + GR | pc | 21584 | 21586 | | 31261 | 21587 | pc | € 28.03 | € 36.53 | |
| | | | | | | | | | | | |
|  | LOGO Logo for end piece gutter GAS1 and GRS2 | pc | 29943 | | | | | pc | € 4.34 | | |
| | | | | | | | | | | | |
|  | BUGS Universal outlet | pc | 22387 | 22389 | | 31384 | 22391 | pc | € 14.10 | € 22.37 | |
| | | | | | | | | | | | |
|  | WUGS Outlet gutter spout | pc | 22392 | | | | | pc | € 14.76 | | |
| | | | | | | | | | | | |
|  | GI Connecting piece for gutter G | 0.3 | 27732 | | | | | pc | € 27.81 | | |
| | | | | | | | | | | | |
|  | 9091 Connecting plate for gutter G120A (50 x 13 x 2.5mm) | pc | 12368 | | | | | pc | € 3.04 | | |
| | | | | | | | | | | | |
|  | 909 Connecting pins for G or raised profile GR | pc | 8434 | | | | | pc | € 0.99 | | |
| | | | | | | | | | | | |
|  | Y16P Thermal break in ABS 16mm black - for rubber C11CX with gutter G | 1 | 21528 | | | | | m | € 4.54 | | |
| | | 4 | 21529 | | | | | m | € 4.54 | | |
|  | GC PVC water outlet + swivel Ø 80 (grey or brown) | pc | | 13308 | 13450 | | | pc | € 12.55 | | |
| | | | | | | | | | | | |
|  | GB Sealing tape gutter connector 350 x 225mm | pc | 13309 | | | | | pc | € 7.97 | | |
| | | | | | | | | | | | |
|  | 411 Outlet 3m + socket 5 years colour guarantee | 3 | | 10523 | 10524 | | | m | € 15.45 | | |
| | 412 Bracket for outlet | pc | | 10526 | 10527 | | | pc | € 4.33 | | |
| | 412S Screw for bracket | pc | 10532 | | | | | pc | € 0.54 | | |
| | 413 Elbow 67° 30 with socket Ø 80mm | pc | | 10528 | 10529 | | | pc | € 9.98 | | |
| | 414 Elbow 87° with socket Ø 80mm | pc | | 10530 | 10531 | | | pc | € 9.98 | | |
| | BR T-connecting piece 67°-30 Ø 80mm | pc | | 15180 | 15181 | | | pc | € 13.21 | | |
| | | | | | | | | | | | |
| | | | | | | | | | | | |
| | | | | | | | | | | | |
| | | | | | | | | | | | |

FINISH | O : mill-finished aluminium / W : white or RAL 9010 / B : brown / A : anthracite or RAL 7016 structure in stock
RAL colour cost possible for order Color-Therm Glass : +15% on price of white and with start up cost of + € 200 net

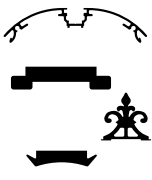
4. Ridge profiles

| GROUP | TYPE | DESCRIPTION | LENGTH | ARTICLE NUMBER | | | | UN. | PRICE / UNIT | |
|---|----------------|---|--------|----------------|--------|-------|--|-----|--------------|---------|
| NP | RIDGE PROFILES | | M | O | W 9010 | RAL | | O | W | |
|  | 841 | Ridge profile Combine with 844, C4CX (2 x), C9 and C10 | 7.6 | 17559 | 17566 | 17588 | | m | € 51.97 | € 56.62 |
| | 844 | Cover profile ridge (anodised aluminium) | 6.5 | 16793 | | | | pc | € 41.75 | |
| | 847 | Lily ridge | pc | 16803 | 16805 | 16807 | | pc | € 48.81 | € 84.45 |
| | C9 | Rubber for ridge profile 841 (black) | 50 | 16795 | | | | m | € 3.24 | |
| | C10 | Rubber flashing 200mm (black) | 25 | 18747 | | | | m | € 5.51 | |
| | 846 | End piece for ridge profile | pc | 16799 | 16800 | 16802 | | pc | € 33.76 | € 38.82 |

5A. Finishing profiles

| GROUP | TYPE | DESCRIPTION | LENGTH | ARTICLE NUMBER | | | | UN. | PRICE / UNIT | | |
|---|------------------------|---|--------|----------------|--------|----------|-------|-----|--------------|---------|--------|
| U - L | END PIECES FOR GLAZING | | M | O | W 9010 | A 7016ST | RAL | | O | W/A | |
|  | U16P | reinforced PVC end profile for sheets 16mm | 0.98 | | 13383 | | | | pc | € 4.82 | |
| | | | 1.053 | | 13384 | | | | pc | € 5.20 | |
| | | | 1.2 | | 13385 | | | | pc | € 5.90 | |
| | | | 1.25 | | 13386 | | | | pc | € 6.19 | |
| | | | 6.4 | | 13396 | | | | pc | € 31.56 | |
| | U25P | reinforced PVC end profile for sheets 25mm | 1.2 | | 13397 | | | | pc | € 7.39 | |
| | | | 2.1 | | 35375 | | | | pc | € 12.95 | |
| | | | 5 | | 13441 | | | | pc | € 30.82 | |
| | U32P | reinforced PVC end profile for sheets 32mm | 0.98 | | 17874 | | | | pc | € 6.90 | |
| | | | 1.053 | | 27249 | | | | pc | € 7.44 | |
| 1.23 | | | | 13400 | | | | pc | € 8.48 | | |
| 1.25 | | | | 13401 | | | | pc | € 8.64 | | |
| 5 | | | | 13440 | | | | pc | € 34.48 | | |
|  | U16A | Alu end profile for sheets 16mm | 0.98 | 13406 | | | 17210 | pc | € 5.39 | | |
| | | | 1.053 | 13407 | | | 17211 | pc | € 5.84 | | |
| | | | 1.2 | 13408 | | | 17212 | pc | € 6.62 | | |
| | | | 6.5 | 18321 | | | 23210 | pc | € 35.83 | | |
| | U32A | Alu end profile for sheets 32mm | 1.23 | 13469 | | | 15917 | pc | € 9.68 | | |
|  | U16 | Pre-drilled alu end profile for sheets 16mm | 0.98 | 23553 | 23569 | 31183 | 23565 | pc | € 9.75 | € 12.94 | |
| | | | 1.053 | 23554 | 23570 | 31184 | 23566 | pc | € 10.45 | € 12.94 | |
| | | | 1.2 | 23555 | 23571 | 31185 | 23567 | pc | € 11.92 | € 15.45 | |
| | | | 6.1 | 23556 | 23572 | 31186 | 23568 | pc | € 65.22 | € 85.72 | |
| | U32 | Pre-drilled alu end profile for sheets 32mm | 0.98 | 27239 | 27245 | 31396 | 27243 | pc | € 12.35 | € 15.93 | |
| | | | 1.23 | 21534 | 21552 | 31195 | 21555 | pc | € 15.12 | € 19.49 | |
| | | | 5 | 21535 | 21553 | 31196 | 21556 | pc | € 61.48 | € 79.24 | |
| | U55 | Pre-drilled alu end profile for sheets 55mm | 1.23 | 69742 | 69744 | 69743 | | pc | € 18.28 | € 23.38 | |
| | L432 | L 40/30/2 alu finishing profile for glass 8-34mm thickness | 6 | 23529 | 23552 | 31160 | 23551 | | m | € 8.26 | € 9.50 |

FINISH | O : mill-finished aluminium / W : white or RAL 9010 / A : anthracite or RAL 7016 structure in stock
RAL colour cost possible for order Color-Therm Glass : +15% on price of white and with start up cost of + € 200 net

| GROUP | TYPE | DESCRIPTION | LENGTH | ARTICLE NUMBER | | | UN. | PRICE/UN. | | |
|-------|-------------------------|--|--------|----------------|--------|-----------|-------|-----------|---------|---------|
| U - H | CONNECTION ALU PROFILES | | M | 0 | W 9010 | A 7016 ST | RAL | 0 | W/A | |
| | HU | Aluminum corner profile for connection of vertical sheets 16mm | 3 | 46429 | | | m | € 11.98 | | |
| | | | 4 | 46430 | | | m | € 11.98 | | |
| | | | 7 | 46431 | | | m | € 11.98 | | |
| | H | Aluminum connection profile for vertical sheets 16mm | 3.04 | 46426 | 71948 | 71949 | 71947 | m | € 12.77 | € 14.69 |
| | | | 4 | 46427 | | | m | € 12.77 | | |
| | | | 7 | 46428 | | | m | € 12.77 | | |









| GROUP | TYPE | DESCRIPTION | LENGTH | THICKN. | ARTICLE NUMBER | | | UN. | PRICE/UN. | |
|-------|------------------------|---|--------|---------|----------------|--|--|-----|-----------|--|
| U - H | POLYCARBONATE PROFILES | | M | MM | | | | | | |
| | UPH | Transparent polycarbonate connecting profile for vertical sheets (6-10-16mm) | 6 | 6 | 13435 | | | pc | € 41.47 | |
| | | | | 10 | 13418 | | | pc | € 48.61 | |
| | | | | 16 | 13434 | | | pc | € 72.89 | |
| | UPU | Transparent polycarbonate end profile for 6-10-16mm sheets Not for outdoor use | 2.1 | 6 | 13438 | | | pc | € 3.82 | |
| | | | | 10 | 13436 | | | pc | € 5.81 | |
| | | | | 16 | 13437 | | | pc | € 8.23 | |
| | UA16 | Filling profile for Alltop sheets with sawn borders | 3.5 | 16 | 12671 | | | pc | € 35.63 | |

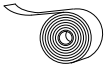

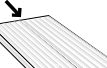
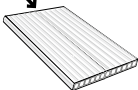
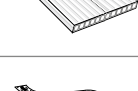

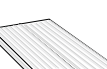
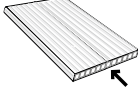
| GROUP | TYPE | DESCRIPTION | LENGTH | ARTICLE NUMBER | | | UN. | PRICE/UN. | | |
|-------|--------------------------------------|--|--------|----------------|--------|-----------|-------|-----------|---------|---------|
| W | PROFILES FOR TRIANGLE AND SIDE WALLS | | M | 0 | W 9010 | A 7016 ST | RAL | 0 | W/A | |
| | WB | Base profile for triangle and side wall 42mm for glass 10mm or PC 16mm | 5.04 | 65849 | 65852 | 65851 | 65850 | m | € 13.18 | € 15.55 |
| | | | 7.04 | 65853 | 65856 | 65855 | 65854 | m | € 13.18 | € 15.55 |
| | WC | Clips profile for WB | 5.04 | 65857 | 65860 | 65859 | 65858 | m | € 4.81 | € 5.98 |
| | | | 7.04 | 65861 | 65864 | 65863 | 65862 | m | € 4.81 | € 5.98 |
| | WU | Side profile U for triangle or side wall | 1.5 | 65865 | 65868 | 65867 | 65866 | m | € 6.52 | € 8.14 |
| | | | 3.04 | 65869 | 65872 | 65871 | 65870 | m | € 6.52 | € 8.14 |

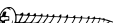
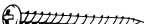

5B. Accessories

| GROUP | TYPE | DESCRIPTION | QUANT. | ARTICLE NUMBER | | | | UN. | PRICE/UNIT | |
|-------|-------|--|--------|----------------|--------|-----------|-------|-----|------------|--------|
| S | STOP | | | 0 | W 9010 | A 7016 ST | RAL | | 0 | W/A |
| | S16 | Stop for alu profiles | pc | 49743 | 13530 | | | pc | € 1.77 | € 5.21 |
| | S16C | Esthetic stop for alu profiles with 16mm sheets | pc | 15582 | 15583 | | | pc | € 3.05 | € 5.40 |
| | S32C | Esthetic stop for alu profiles with 25 and 32mm sheets | pc | 15584 | 15585 | | | pc | € 3.30 | € 5.90 |
| | S16.3 | Stop 3mm for T16P, TP and LP with 16mm sheets | pc | 21218 | 21562 | 31255 | 21563 | pc | € 3.19 | € 5.19 |
| | S32.3 | Stop 3mm for T16P, TP and LP with 25/32mm sheets | pc | 21220 | 21566 | 31256 | 21567 | pc | € 3.34 | € 5.54 |
| | S38.3 | Stop 3mm for TPG and TPGL with glass | pc | 25079 | 25082 | 31257 | 25083 | pc | € 5.08 | € 5.83 |

FINISH | 0 : mill-finished aluminium / W : white or RAL 9010 / A : anthracite or RAL 7016 structure in stock
RAL colour cost possible for order Color-Therm Glass : +15% on price of white and with start up cost of + € 200 net

| GROUP | TYPE | DESCRIPTION | QUANTITY | ARTICLE NUMBER | UN. | PRICE/UNIT |
|--|--------------|---|------------------------|----------------|-----|------------|
| B | TAPES | | ROLL LENGTH (M) | | | |
|  | BTA | Anti-dust alu tape | 50 | 13369 | st | € 24.61 |
|  | BT16 | Closed synthetic tape for 10 and 16mm sheets – With guarantee | 10 | 14408 | st | € 11.10 |
| | | | 33 | 82953 | st | € 23.65 |
|  | BT25 | Closed synthetic tape for 25mm sheets –With guarantee | 10 | 14411 | st | € 12.64 |
| | | | 33 | 82954 | st | € 23.43 |
|  | BT32 | Closed synthetic tape for 32mm sheets – With guarantee | 10 | 14413 | st | € 15.23 |
| | | | 33 | 82955 | st | € 28.32 |
|  | BT55 | Closed synthetic tape for 55mm sheets – With guarantee | 33 | 82956 | st | € 61.06 |
| | | | | | | |
|  | BB16 | Perforated synthetic tape for 16mm sheets – With guarantee | 10 | 13372 | st | € 20.70 |
| | | | 33 | 13373 | st | € 49.64 |
|  | BB25 | Perforated synthetic tape for 25mm sheets – With guarantee | 10 | 14416 | st | € 27.42 |
| | | | 33 | 14424 | st | € 64.67 |
|  | BB32 | Perforated synthetic tape for 32mm sheets – With guarantee | 10 | 13374 | st | € 35.67 |
| | | | 33 | 13376 | st | € 85.31 |
|  | BB55 | Perforated synthetic tape for 55mm sheets – With guarantee | 33 | 60353 | st | € 147.84 |
| | | | | | | |
|  | BM | One-sided adhesive tape 15 x 8mm for sealing between sheets and wall profile M16 / M32B | 6 | 13377 | st | € 5.70 |
|  | BANDV | One-sided adhesive tape 12 x 3-7mm | 6 | 73799 | pc | € 33.03 |

| GROUP | TYPE | DESCRIPTION | QUANT. | ARTICLE NUMBER | | | | UN. | PRICE/UNIT | |
|---|-----------------------------|---|--------|----------------|----------|----------|------------|----------|------------|------------|
| MT | MOUNTING ACCESSORIES | | | 0 | W | A | RAL | | 0 | W/A |
|  | HILO25 | Galvanised hilo screw for PVC 5.2 x 25mm for CLSB (set of 25 pcs) | 25 pcs | 24202 | | | | set (25) | € 6.00 | |
|  | HILO40 | Galvanised hilo screw for PVC 5.2 x 40mm for CLSB (set of 25 pcs) | 25 pcs | 24201 | | | | set (25) | € 6.00 | |
|  | HILO45 | Stainless steel hilo screw for PVC 6 x 45mm for CLSB (set of 25 pcs) | 25 pcs | 82206 | | | | set (25) | € 11.00 | |
|  | ZSC | Stainless steel screw 5.5 x 32 + butyl sealing TX 25 self drilling for TP - TPG | pc | 23963 | | | | pc | € 1.17 | |
|  | ZSB/G | Stainless steel screw 5.5 x 32 TX 25 self drilling for TP - TPG | pc | 20911 | 18740 | 31382 | 21596 | pc | € 0.52 | € 0.67 |
|  | PS48 | Self drilling stainless Parker screw 4.8 x 25mm for stop | pc | 8431 | 22595 | 31383 | 22598 | pc | € 0.50 | € 0.67 |
| | BITS | Torxbit TX25 for stainless steel screw | pc | 18744 | | | | pc | € 3.30 | |
| | GATZ | Core drill Ø 80mm | pc | 41354 | | | | pc | € 31.86 | |
| | KAL8 | PVC buffer for single glazing | pc | 27578 | | | | pc | € 0.28 | |
| | KAL20 | PVC buffer for double glazing | pc | 27331 | | | | pc | € 0.45 | |
| | KAL28 | PP buffer 28mm for glazing in profile WB | pc | 69951 | | | | pc | € 0.62 | |

| GROUP | TYPE | DESCRIPTION | QUANT. | ARTICLE NUMBER | | | | UN. | PRICE/UNIT | |
|---|----------------------|--|--------|----------------|----------|----------|----------------|-----|--------------|------------|
| | MISCELLANEOUS | | | 0 | W | A | RAL | | 0/W/A | RAL |
| | LAK | Paint brush for repair | pc | | 24198 | 31385 | 24199 | pc | € 12.80 | € 25.50 |
|  | SILI | Silicone 310ml for use with PMMA and PC – warranty 10 years with certificate mill-finished & RAL = transparant | pc | 15460 (transp) | 4736 | | 15460 (transp) | pc | € 11.38 | € 11.38 |
|  | SG20 | Silicone glue 310ml for glass connector GVB and GVT (black) | pc | 109085 | | | | pc | € 38.45 | |

FINISH | 0 : mill-finished aluminium / W : white or RAL 9010 / A : anthracite or RAL 7016 structure in stock
RAL colour cost possible for order Color-Therm Glass : +15% on price of white and with start up cost of + € 200 net

6. Prepacked profiles with PE film

One packing contains: 1 profile + stop profile + matching rubber or clip + label with description and bar code.

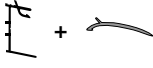
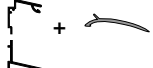
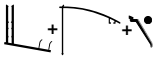
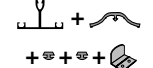
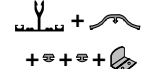
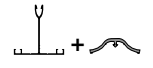
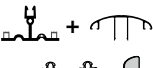
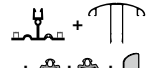
| GROUP | TYPE | DESCRIPTION | LENGTH | ARTICLE NUMBER | | UN. | PRICE/M | | PRICE STOP |
|---|---|--|--------|----------------|--------|------------|------------|------------|--------------|
| | | | | O | W 9010 | | O | W | stop + screw |
| E |  | EM16 M16 + C4CX Set of wall profiles for series ALU / COLOR | 3.5 | 13429 | 15887 | pc | € 22.67 /m | € 24.91 /m | - |
| | | | 5 | 13431 | 15741 | pc | | | |
| | | | 7 | 13432 | 15840 | pc | | | |
| |  | EM32 M32T + M32B + C4CX Set of wall profiles for series ALU / COLOR | 3.5 | 26655 | | pc | € 30.56 /m | - | - |
| | | | 5 | 26656 | | pc | | | |
| | | | 7 | 43972 | | pc | | | |
| |  | EMP MP + CLM + C1CX + C12 Set of wall profiles for series COLOR-THERM / COLOR-THERM GLASS | 3.5 | | 18186 | pc | - | € 43.09 /m | - |
| | | | 5 | | 17943 | pc | | | |
| | | | 7 | | 17972 | pc | | | |
| |  | ET16.1 T16.1 + C2CX (grey) + C3 (2x) + S16C + screw (2x) Set of rafter profiles for series ALU | 2.5 | 13289 | | pc | € 20.73 /m | - | € 4.86 |
| | | | 3 | 13300 | | pc | | | |
| | | | 3.5 | 13302 | | pc | | | |
| | | | 4 | 13303 | | pc | | | |
| | | | 5 | 14583 | | pc | | | |
| | | | 6 | 13304 | | pc | | | |
| 7 | | | 13305 | | pc | | | | |
|  | ET16.2 T16.2 + C2CX + C3 (2x) + S16C + screw (2x) Set of rafter profiles for series ALU / COLOR | 2.5 | 13278 | 13796 | pc | € 23.82 /m | - | € 4.86 | |
| | | 3 | 13279 | 13722 | pc | | | | |
| | | 3.5 | 13282 | 14204 | pc | | | | |
| | | 4 | 13284 | 15011 | pc | | | | |
| | | 5 | 14684 | | pc | | | | |
| | | 6 | 13286 | | pc | | | | |
|  | ET32.1 T32.1 + C2CX + C3 (2x) + S32C + screw (2x) Set of rafter profiles for series ALU / COLOR | 2.5 | 30993 | | pc | € 21.65 /m | - | € 5.16 | |
| | | 3 | 23577 | 44834 | pc | | | | |
| | | 3.5 | 23578 | 46379 | pc | | | | |
| | | 4 | 23579 | 43964 | pc | | | | |
| | | 5 | 27568 | 43965 | pc | | | | |
| | | 6 | 31640 | | pc | | | | |
| | | 7 | 42877 | | pc | | | | |
|  | ETP 16 T16P + CL16 + C8 + C8 + S16.3 + screw Set of rafter profiles for series COLOR-THERM | 2.5 | | 18408 | pc | - | € 31.74 /m | € 7.03 | |
| | | 3 | | 18100 | pc | | | | |
| | | 3.5 | | 18108 | pc | | | | |
| | | 4 | | 18223 | pc | | | | |
| | | 5 | | 17971 | pc | | | | |
| | | 6 | | 18410 | pc | | | | |
| | | 7 | | 18187 | pc | | | | |
|  | ETP 32 T16P + CL32 + C8 + C8 + S32.3 + screw Set of rafter profiles for series COLOR-THERM | 2.5 | | 18627 | pc | - | € 36.12 /m | € 7.45 | |
| | | 3 | | 18284 | pc | | | | |
| | | 3.5 | | 18188 | pc | | | | |
| | | 4 | | 18027 | pc | | | | |
| | | 5 | | 17945 | pc | | | | |
| | | 6 | | 17946 | pc | | | | |
| | | 7 | | 18107 | pc | | | | |

FINISH | O : mill finished aluminium / W : white or RAL 9010

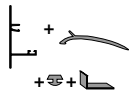
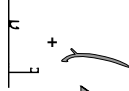
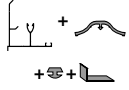
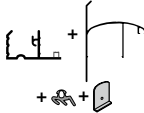
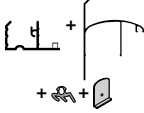







| GROUP | TYPE | DESCRIPTION | LENGTH | ARTICLE NUMBER | | UN. | PRICE/M | | PRICE STOP | |
|---|--------------------|--|--------|----------------|--------|-----|------------|------------|--------------|------------|
| E | PREPACKED PROFILES | | M | O | W 9010 | | O | W | stop + screw | |
|  | EL16 | L16 + C4CX (grey) + C3 + S16C + screw (2x) | 2.5 | 13375 | | pc | € 19.35 /m | - | € 4.86 | |
| | | Set of side rafter profiles for series ALU | 3 | 13420 | | pc | | | | |
| | | | 3.5 | 13421 | | pc | | | | |
| | | | 4 | 13422 | | pc | | | | |
| | | | 4.5 | 26238 | | pc | | | | |
| | | | 5 | 14629 | | pc | | | | |
| | | | 6 | 13423 | | pc | | | | |
|  | EL32 | L32.1+ C4CX (grey)+ C3 + S32C + screw (2x) | 2.5 | 26632 | | pc | € 21.09 /m | - | € 5.16 | |
| | | Set of side rafter profiles for series ALU | 3 | 23580 | | pc | | | | |
| | | | 3.5 | 23581 | | pc | | | | |
| | | | 4 | 23582 | | pc | | | | |
| | | | 5 | 16093 | | pc | | | | |
| | | | 6 | 31641 | | pc | | | | |
|  | ELT16 | LT16 + C2CX + C3 + S16C + screw (2x) | 2.5 | 22805 | | pc | € 25.00 /m | - | € 4.86 | |
| | | Set of side rafter profiles for series COLOR | 3 | 22806 | 16696 | pc | | | | € 29.06 /m |
| | | | 3.5 | 22898 | 21439 | pc | | | | |
| | | | 4 | | 16579 | pc | | | | |
| | | | 5 | | 16697 | pc | | | | |
| | 6 | 16729 | | pc | | | | | | |
|  | ELP 16 | LP + CLL + C8 + S16.3 + screw | 2.5 | | 18185 | pc | - | € 45.17 /m | € 7.03 | |
| | | Set of side rafter profiles for series COLOR-THERM | 3 | | 18103 | pc | | | | |
| | | | 3.5 | | 18109 | pc | | | | |
| | | | 4 | | 18222 | pc | | | | |
| | | | 5 | | 17941 | pc | | | | |
| | | | 6 | | 17942 | pc | | | | |
| | | | 7 | | 18442 | pc | | | | |
|  | ELP 32 | LP + CLL + C8 + S32.3 + screw | 2.5 | | 23953 | pc | - | € 45.17 /m | € 7.45 | |
| | | Set of side rafter profiles for series COLOR-THERM | 3 | | 23621 | pc | | | | |
| | | | 3.5 | | 23545 | pc | | | | |
| | | | 4 | | 23262 | pc | | | | |
| | | | 5 | | 23165 | pc | | | | |
| | | | 6 | | 23026 | pc | | | | |
| | | | 7 | | 25552 | pc | | | | |

Other profiles also available prepacked: price and terms of delivery on request

FINISH | O : mill finished aluminium / W : white or RAL 9010

Polyclear price list

Multi-walled flat polycarbonate sheets

| TYPE | STANDARD | | | | | | | | | | X STRUCTURE | | | | | | | | NEW |
|---------------------------------------|---|------|---|------|------|------|---|------|---|------|---|------|---|-----|---|------|---|----|-----|
| | 6mm ⊗ | | 10mm ⊗ | | | | 16mm | | 16mm | | 16mm | | | | 25mm | | | | |
| THICKNESS (mm) | 2W | | 4W | | | | 3W 2uv | | 3W 16/32mm 2uv | | TOP X5 | | TOP X6 | | TOP X6 | | TOP X11 | | |
| UV COEXTRUSION |  | |  | | | |  | |  | |  | |  | |  | |  | | |
| WEIGHT (g/m ²) | 1300 | | 1750 | | | | 2600 | | 4000 | | 2400 | | 2500 | | 3300 | | 3200 | | |
| INSULATION VALUE (W/m ² K) | 3.6 | | 2.2 | | | | 2.2 | | 2.5 | | 2.0 | | 1.9 | | 1.5 | | 1.4 | | |
| COLOUR | CLEAR | OPAL | CLEAR/OPAL | | | | CLEAR/OPAL | | CLEAR/OPAL | | CLEAR/OPAL | | CLEAR/OPAL | | OPAL | OPAL | | | |
| WIDTH mm → | 2100 | 2100 | 980 | 1050 | 1200 | 2100 | 980 | 1200 | 980 | 1200 | 980 | 1050 | 2100 | 980 | 1050 | 2100 | 1050 | | |
| ↓ LENGTH mm | | | | | | | | | | | | | | | | | | | |
| 2000 | | | | ○ | ○ | ○ | ○ | | | ○ | | ○ | ○ | ○ | | | | | |
| 2500 | | | ● | ● | ● | ● | ○ | | | ○ | | | ● | | ● | | | | |
| 2750 | | | | | | | | | | | | | ● | | ● | | | | |
| 3000 | | | ● | ● | ● | ● | ○ | ○ | ● | | | ● | ○ | ● | | | | | |
| 3250 | | | | | | | | | | | | | ● | | ● | | | | |
| 3500 | | | ● | ● | ● | ● | ○ | ○ | ● | | | ● | ○ | ● | | | | | |
| 3750 | | | | | | | | | | | | | ● | | ● | | | | |
| 4000 | | | ● | ● | ● | ● | ○ | ○ | ● | | | ● | ○ | ● | | | | | |
| 4250 | | | | ○ | | | | | | | | | ● | | ● | | | | |
| 4500 | | | | ● | ○ | ● | ○ | | ● | | | ● | ○ | ● | | | | | |
| 4750 | | | | ○ | | | | | | | | | | | | | | | |
| 5000 | | | | ● | ○ | ● | ○ | | ○ | ○ | | ● | ○ | ● | ○ | | ● | | |
| 6000 | ● | ○ | | ● | | ● | ○ | | ○ | | | ● | ● | ● | ● | | ● | | |
| 7000 | ● | | | ● | ○ | ● | ○ | | ○ | ○ | | ● | ● | ● | ● | ● | ● | | |
| 7200 | | | | | | | | | | | | | | | | | | | |
| #/pallet | 30 | 30 | 50 | 50 | 50 | 50* | 30 | 30 | 30 | 30 | 30 | 30 | 30 | 30 | 30 | 20 | 20 | 30 | |



Super insulating

○ While stocks last

⊗ These sheets cannot be used in canopies or veranda roofs; but can be used in barrel vaults and other applications. For more information please call us +32 56 20 00 00 or send us a mail info@skylux.be

* 2100 x 7000mm: 45 pieces/pallet

| X STRUCTURE | | | HEATSTOP NEW | | | | | | | | | | TYPE |
|-------------|------------|-------|---|--------------|-----------|-----------------|--------------------|----------|----------|----------|--------|---------------------------------------|----------------|
| 32mm | | | 10mm | 16mm | 16mm | | | | 32mm | | | 55mm | THICKNESS (mm) |
| TOP X6 | TOP X11 EP | RELAX | RELAX | REFLEX PEARL | PRIMALITE | REFLEX PEARL EP | PRIMALITE EP | RELAX HX | HEATSTOP | | | | |
| | | | | | | | | | | | | UV COEXTRUSION | |
| 3700 | 3800 | 1750 | 2400 | 2500 | 2500 | 3800 | 3800 | 3600 | 5000 | | | WEIGHT (g/m ²) | |
| 1.4 | | 2.5 | 2.0 | 2.1 | 2.1 | | | 1.1 | | | | INSULATION VALUE (W/m ² K) | |
| CLEAR/OPAL | CLEAR/OPAL | OPAL | OPAL | OPAL | CLEAR | OPAL | SATIN [■] | CLEAR | OPAL | OPAL | COLOUR | | |
| 980 1230 | 980 1230 | 1050 | 980 | 980 1200 | 980 1200 | 980 1230 | 980 1230 1230 | 980 1230 | 1230 | 980 1230 | 1230 | ← WIDTH mm ↓ LENGTH mm | |
| ○ ○ ○ | | | | | | | ○ | | | ○ | | 2000 | |
| ● ● ● | | ● ○ ● | | ● ● ● | | ● ● ● | | ● ● ● | | ● ● ● | | 2500 | |
| ○ ○ ○ | | | | | | | | | | | | 2750 | |
| ● ● ● | | ● ○ ● | | ● ● ● | | ● ● ● | ○ | ● ● ● | | ● ● ● | ● | 3000 | |
| ● ● ● | | | | | | | | | | | ● | 3250 | |
| ● ● ● | | ● ○ ● | | ● ● ● | | ● ● ● | | ● ● ● | | ● ● ● | ● | 3500 | |
| ● ● ○ | | | | | | | | | | | ● | 3750 | |
| ● ● ● | | | ○ | ● ● ● | | ● ● ● | | ● ● ● | | ● ● ● | ● | 4000 | |
| ● ● ○ | | ● | | | | | | | | | | 4250 | |
| ● ● ● | | | ○ | ● ● ● | | ● ● ● | | ● ● ● | | ● ● ● | ● | 4500 | |
| | | | | | | | | | | | | 4750 | |
| ● ● ● | | ● ○ ● | | ● ● ● | | ● ● ● | | ● ● ● | | ● ● ● | ● | 5000 | |
| ● ● ● | | | ○ | ● ● ● | | ○ ● ● | | ● ● ● | | ● ● ● | ● | 6000 | |
| ○ ● ● | | | ○ | ● ● ● | | ● ● ● | | ● ○ ● | | | ● | 7000 | |
| | | ● | | | | | | | | | | 7200 | |
| 15 15 20 | | 50 | 30 | 30 30 | 30 30 | 20 | 20 20 | 20 | 20 | 10 | | #/pallet | |

■ Opal with satin finish

- Prices, quantity and delivery time for cut-to-size sheets, colours and special executions are on request
- For lengths > 7m and min 500kg: price on request
- Cut-to-size is possible
- Tolerance on sizes: see technical file

Technical properties Polyclear

| | width (mm) | colour | weight (kg) | light transmission (%) | U value (W/m²K) | blocked energy (l-g) | sound insulation (dB) | minimum permissible cold bending radius (m) * | max. laylength (m) ** | |
|-----------------------------------|------------|--------|-------------|------------------------|-----------------|----------------------|-----------------------|---|-----------------------|---------|
| | | | | | | | | | 500N/m² | 750N/m² |
| Polyclear 10mm 4-walled | 980 | clear | 1.75 | 68% | 2.5 | 35% | 17 | 1.5 | 2.0m | 1.6m |
| | 1050**** | clear | 1.75 | 68% | 2.5 | 35% | 17 | 1.5 | 2.0m | 1.6m |
| | 1200 | clear | 1.75 | 68% | 2.5 | 35% | 17 | 1.5 | 2.0m | 1.6m |
| | 2100 | clear | 1.75 | 68% | 2.5 | 35% | 17 | 1.5 | *** | *** |
| | 980 | opal | 1.75 | 61% | 2.5 | 39% | 17 | 1.5 | 2.0m | 1.6m |
| | 1050**** | opal | 1.75 | 61% | 2.5 | 39% | 17 | 1.5 | 2.0m | 1.6m |
| | 1200 | opal | 1.75 | 61% | 2.5 | 39% | 17 | 1.5 | 2.0m | 1.6m |
| Polyclear 3-walled 2 x UV 16mm | 980 | clear | 2.6 | 74% | 2.2 | 30% | 18 | 2.4 | ⌘ | 5.3m |
| | 1200 | clear | 2.6 | 74% | 2.2 | 30% | 18 | 2.4 | ⌘ | 5.0m |
| | 980 | opal | 2.6 | 62% | 2.2 | 38% | 18 | 2.4 | ⌘ | 5.3m |
| | 1200 | opal | 2.6 | 62% | 2.2 | 38% | 18 | 2.4 | ⌘ | 5.0m |
| Polyclear 3-walled 2 x UV 16/32mm | 980 | clear | 4 | 74% | 2.5 | 34% | 23 | - | ⌘ | 20m |
| | 1200 | clear | 4 | 74% | 2.5 | 34% | 23 | - | 14m | 3m |
| | 980 | opal | 4 | 39% | 2.5 | 53% | 23 | - | ⌘ | 20m |
| | 1200 | opal | 4 | 39% | 2.5 | 53% | 23 | - | 14m | 3m |
| TOP X5 16mm | 980 | clear | 2.4 | 64% | 2.0 | 39% | 21 | 2.4 | ⌘ | ⌘* |
| | 1050**** | clear | 2.4 | 64% | 2.0 | 39% | 21 | 2.4 | ⌘ | ⌘* |
| | 1200 | clear | 2.4 | 64% | 2.0 | 39% | 21 | 2.4 | 6m | 3.5m |
| | 2100 | clear | 2.4 | 64% | 2.0 | 39% | 21 | 2.4 | *** | *** |
| | 980 | opal | 2.4 | 55% | 2.0 | 46% | 21 | 2.4 | ⌘ | ⌘* |
| | 1050**** | opal | 2.4 | 55% | 2.0 | 46% | 21 | 2.4 | ⌘ | ⌘* |
| | 1200 | opal | 2.4 | 55% | 2.0 | 46% | 21 | 2.4 | 6m | 3.5m |
| TOP X6 16mm | 980 | clear | 2.5 | 62% | 1.9 | 39% | 21 | 3.5 | ⌘ | ⌘* |
| | 1050 | clear | 2.5 | 62% | 1.9 | 39% | 21 | 3.5 | ⌘ | ⌘* |
| | 1200 | clear | 2.5 | 62% | 1.9 | 39% | 21 | 3.5 | ⌘* | ⌘* |
| | 2100 | clear | 2.5 | 62% | 1.9 | 39% | 21 | 3.5 | *** | *** |
| | 980 | opal | 2.5 | 48% | 1.9 | 45% | 21 | 3.5 | ⌘ | ⌘* |
| | 1050 | opal | 2.5 | 48% | 1.9 | 45% | 21 | 3.5 | ⌘ | ⌘* |
| | 1200 | opal | 2.5 | 48% | 1.9 | 45% | 21 | 3.5 | ⌘* | ⌘* |
| TOP X6 25mm | 1050 | clear | 3.3 | 61% | 1.5 | 39% | 22 | 5.3 | *** | *** |
| | 2100 | opal | 3.3 | 46% | 1.5 | 44% | 22 | 5.3 | *** | *** |
| TOP X11 25mm | 1050 | opal | 3.2 | 38% | 1.4 | 55% | 19 | 3.75 | *** | *** |
| TOP X6 32mm | 980 | clear | 3.7 | 60% | 1.4 | 39% | 22 | 7.3 | ⌘ | ⌘ |
| | 1230 | clear | 3.7 | 60% | 1.4 | 39% | 22 | 7.3 | ⌘ | ⌘ |
| | 980 | opal | 3.7 | 40% | 1.4 | 46% | 22 | 7.3 | ⌘ | ⌘ |
| | 1230 | opal | 3.7 | 40% | 1.4 | 46% | 22 | 7.3 | ⌘ | ⌘ |
| TOP X11 EP 32mm | 980/1230 | clear | 3.8 | 42% | 1.0 | 57% | 23 | 4.4 | ⌘ | ⌘ |
| | 980/1230 | opal | 3.8 | 16% | 1.0 | 70% | 23 | 4.4 | ⌘ | ⌘ |
| REFLEX PEARL 16mm | 980/1200 | opal | 2.5 | 26% | 2.1 | 68% | 21 | 2.8 | ⌘ | ⌘ |
| REFLEX PEARL EP 32mm | 980/1230 | opal | 3.8 | 12% | 1.0 | 68% | 23 | 4.4 | ⌘ | ⌘ |
| PRIMALITE 16mm | 980/1200 | clear | 2.5 | 42% | 2.1 | 65% | 21 | 2.8 | ⌘ | ⌘ |
| PRIMALITE EP 32mm | 1230 | clear | 3.8 | 30% | 1.0 | 64% | 23 | 4.4 | ⌘ | ⌘ |
| | 980/1230 | satin | 3.8 | 10% | 1.0 | 82% | 23 | 4.4 | ⌘ | ⌘ |
| RELAX 10mm | 1050 | opal | 1.75 | 52% | 2.5 | 51% | 17 | 1.5 | 2.0m | 1.6m |
| RELAX 16mm | 980 | opal | 2.4 | 47% | 2.0 | 55% | 21 | 2.4 | ⌘ | ⌘* |
| RELAX HX 32mm | 980 | opal | 3.6 | 29% | 1.1 | 56% | 21 | - | ⌘ | ⌘ |
| | 1230 | opal | 3.6 | 29% | 1.1 | 56% | 21 | - | ⌘ | 6.4m |
| Polyclear Heatstop 1 x UV 55mm | 1230 | opal | 5 | 29% | 0.8 | 87% | 23 | - | ⌘ | 5.5m |

- * The cold bending must be parallel to the ribs of the sheets, never crosswise (risk of buckling).
- ** The maximum laylength without transverse rafter. Basis is a load as mentioned, a security factor 1.5 and a maximum bend of 1/40 regard to the sheet width.
- *** Impossible
- **** With 1 open side

- ⌘ No transverse rafter necessary
- ⌘* Laylength 5m max.
- Guarantee per type of sheet available on request
- Tolerance on sizes:
 - thickness ± 0.5mm - width -2 / +6mm
 - length 0 / + 12mm till 3000mm & > 3000 0 / + 0.4%
 (We recommend removing any snow from the roof.)

PLEXIGLAS® price list

Multi-walled flat acrylic sheets

| TYPE | STANDARD | | | | HEATSTOP | |
|-----------------|----------------|------|------------|------|--------------|------|
| THICKNESS (mm) | 16mm | | | | 32mm | |
| CELLS (Th / W) | S2P RESIST AAA | | S2A ALLTOP | | S5P RESIST | |
| PROFILE | 16/64mm | | 16/64mm | | 32/32mm | |
| Weight (g/m²) | 4300 | | 5000 | | 5800 | |
| U value (W/m²K) | 2.5 | | 2.5 | | 1.5 | |
| COLOUR | CLEAR (1) | | OPAL (1) | | OPAL (1) (3) | |
| WIDTH mm → | 980 | 1200 | 980 | 1200 | 980 | 1230 |
| ↓ LENGTH mm | | | | | | |
| 3000 | ● | ○ | ● | ● | ● | ● |
| 3500 | | ○ | ● | ● | ● | ● |
| 4000 | ● | ○ | ● | ● | ● | ● |
| 7000 | ● | | ● | ○ | ● | ● |

- RESIST = improved shock resistance
- AAA = with anti-algae treatment
- (1) NO DROP = coating on one side against condensation
- (2) NO DROP = coating on two sides against condensation
- (3) HEATSTOP = infrared reflective

○ : while stocks last

The sheets are produced on the basis of ISO 9002 according to the ISO 12017 norm with raw materials according to DIN 8745.

Tolerance in sizes: see technical file

SPECIAL SIZES:

Special sizes (to max 7000mm) can be obtained per pallet order at the price of standard lengths (delivery time will be confirmed).

If less than 10 pieces: quantity charge

CUT-TO-SIZE IS POSSIBLE

(We deliver the offcuts if needed)

Pergotop – Pergotop-Soft price list

Sandwich panels

| TYPE | PERGOTOP | | | | | | | PERGOTOP-SOFT |
|------------------------------|-----------|--------------|--------------|------------------------------|-------------|------------------------------|-------------|---|
| | STANDARD | | | ACOUSTIC | | | | ACOUSTIC |
| SHEET THICKNESS (mm) | 16mm | 16mm | 32mm | 32mm | | 57mm | | 32mm |
| WEIGHT (kg/m ²) | 5.30 | 4.85 | 5.35 | 5.75 | | 6.50 | | 5.75 |
| U VALUE (W/m ² K) | 2.40 | 2.07 | 0.96 | 0.96 | | 0.48 | | 0.80 |
| COLOUR | grey/grey | white/white* | white/white* | white/white* slate/white* | tile/white* | white/white* slate/white* | tile/white* | white UV/white* slate UV/white* brown UV/white* |
| SURFACE | 2 x alu | 2 x alu | 2 x alu | 2 x alu | 2 x alu | 2 x alu | 2 x alu | 1 x soft 1 x alu |
| WIDTH mm → | 1200 | 1200 | 1230 | 1230 | 1230 | 1230 | 1230 | 1230 |
| ↓ LENGTH mm | | | | | | | | |
| 2500 | ● | ● | ● | ● | ○ | ○ | | ○ |
| 3000 | | ● | ● | ● | ● | ● | | ● |
| 3250 | ● | | | | | | | |
| 3500 | | ● | ● | ● | ● | ● | | ● |
| 4000 | ● | ● | ● | ● | ● | ● | | ● |
| 4500 | ● | ● | ● | ● | ● | ● | ○ | ● |
| 5000 | ● | ● | ● | ● | ○ | | | ● |
| 6000 | | ● | | ● | | ● | | ● |
| 7000 | | ● | | ● | ● | ○ | ○ | |
| #/pallet | 50 | 30 | 20 | 20 | 20 | 20 | 20 | 20 |

± 1.5mm tolerance on thickness

alu = laquered aluminium / soft = acoustic soft layer

○ : while stocks last

* Pergotop & Pergotop-soft has a white scratchproof inner side
cut-to-size is possible

Price inquiry / Order

Climalux

Customer

Reference – project

Time of delivery

- Inquiry No custom sizes
 Order

Please mark your choice with a cross or specify where necessary

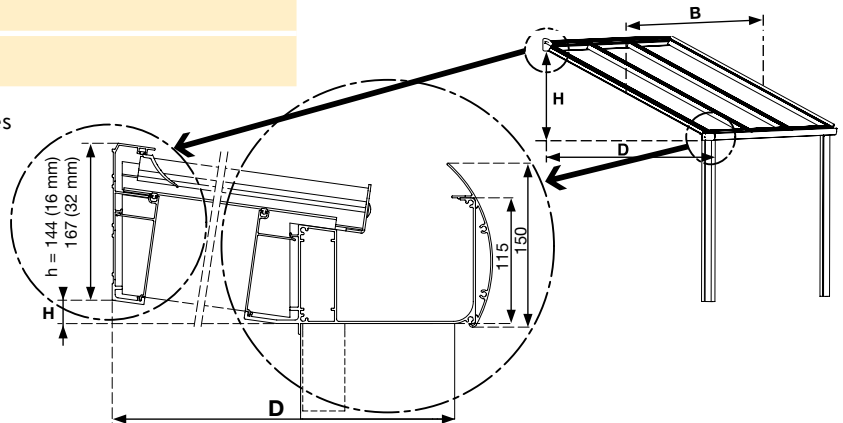

| | | | | |
|---------------------------|--|---|--------------------------------|---|
| Dimensions (in mm) | Width 'B' | | | |
| | Depth 'D' | | | |
| | Height difference 'H' or inclination (between 2° and 10° and from 5° when using multi-walled sheets) | | | |
| | Post length | 2500mm | 3250mm | |
| | Or customised posts (exact length) | | | |
| Standard colours* | RAL 9010 white | | | |
| | RAL 7016 ST anthracite (Tiger 029/71334) | | | |
| Trend colours** | RAL 3004 ST purple red (AE03053300420) | | Other RAL colour*** | RAL |
| | RAL 7039 ST (AE03057703920) | | | Powder code |
| | RAL 8014 ST (AE030588001420) | | Type | Gloss |
| | RAL 9001 cream | | | Textured |
| | RAL 9005 ST cream (Axalta AE3054900520) | | | Matte (30 % gloss) |
| | RAL 9006 ST sliver grey (Tiger 029/90146) | | | |
| | RAL 9007 ST grey aluminium (Tiger 029/90147) | | | |
| | RAL 9009 ST DB 703 (Tiger 029/80077) | | | |
| | RAL 9010 ST (AE03059901020) | | | |
| Sheet type | Polycarbonate/Plexiglas | Type | | |
| | | 16mm thick | | clear |
| | | 32mm thick | | opal |
| | Glass (maximum 750mm glass width) | 8mm glass | | 10mm glass |
| | | | Colour and thickness | |
| or | Pergotop sandwich panels | White/white | | 16mm |
| | Pergotop-Soft sandwich panels | Slate/white | | 32mm |
| | | Tile/white | | Acoustic |
| Gutter | Classic | | | |
| | | Softline | | |
| Post | 110 x 141mm (round) | | | |
| | | 150 x 150mm (square) | | |
| Type | Freestanding roof (installation against GDx) | | | |
| Options | LED lighting under the gutter | for switch (not provided by Skylux) with remote control | | |
| | Climaled (3 spotlights/rafter) (quantity -> min. 2) | 2800K – warm | | → please fill in how many |
| | | 4000K – cold | | → please fill in how many |
| | Triangle profile and/or windbreak (side panels) | | | → see order form triangle profile and windbreak |
| | Climaglide (sliding wall system) | | | → see order form Climaglide |
| | Vertical sunblind | | | → see order form vertical sunblind |
| Roof sunblind | | | → see order form roof sunblind | |
| Remarks | | | | |

* **Standard colours:** no surcharge (delivery time: max. 3 weeks)

** **Trend colours:** € 200 colour change surcharge (delivery time: max. 4 weeks)

*** **Other RAL colours:** + 15 % surcharge + € 200 colour change surcharge (delivery time: max. 4 weeks)
special powder codes on request (+ € 250)

Price inquiry / Order

Climalux with roof overhang

Customer

Reference – project

Time of delivery

Inquiry

No custom sizes

Order

Please mark your choice with a cross or specify where necessary

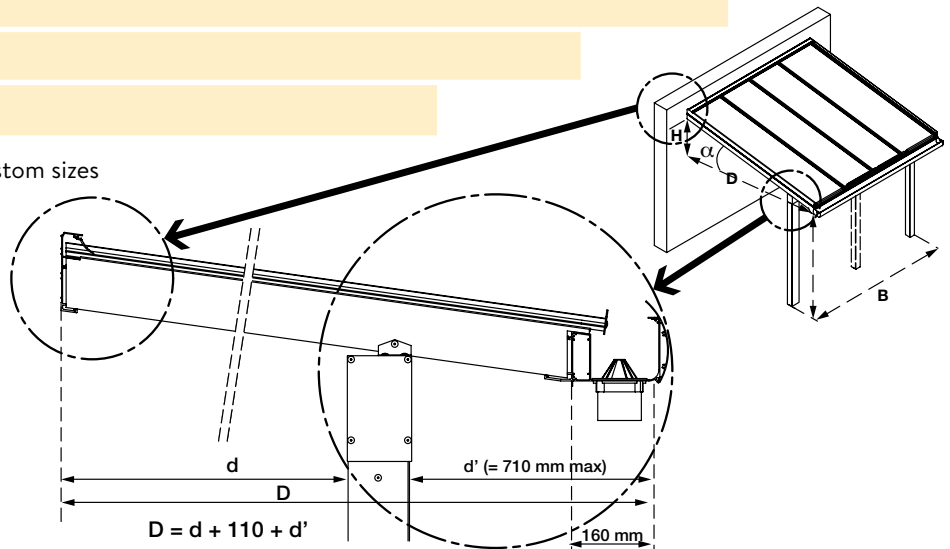

| | | | | | |
|-----------------------------------|--|-------------------------------------|----------|------------------------------------|---|
| Dimensions (in mm) | Width 'B' | | | | |
| | Depth 'D' | | | | |
| | Depth 'd' (to the inside of the post) | | | | |
| | Height difference 'H' or inclination (between 2° and 10° and from 5° when using multi-walled sheets) | | | | |
| | Post length (110 x 110mm) | 2500mm | | 3250mm | |
| | Or customised posts (exact length) | | | | |
| Standard colours* | RAL 9010 white | | | | |
| | RAL 7016 ST anthracite (Tiger 029/71334) | | | | |
| Trend colours** | RAL 3004 ST purple red (AE03053300420) | | | | |
| | RAL 7039 ST (AE03057703920) | | | | |
| | RAL 8014 ST (AE030588001420) | | | | |
| | RAL 9001 cream | | | | |
| | RAL 9005 ST cream (Axalta AE3054900520) | | | | |
| | RAL 9006 ST sliver grey (Tiger 029/90146) | | | | |
| | RAL 9007 ST grey aluminium (Tiger 029/90147) | | | | |
| | RAL 9009 ST DB 703 (Tiger 029/80077) | | | | |
| | RAL 9010 ST (AE03059901020) | | | | |
| Other RAL colour*** | RAL | | | | |
| | Powder code | | | | |
| | Type | Gloss | | | |
| | | Textured | | | |
| | | Matte (30 % gloss) | | | |
| | Sheet type | Polycarbonate/Plexiglas | Type | | |
| 16mm thick | | | | clear | |
| 32mm thick | | | | opal | |
| Glass (maximum 750mm glass width) | | 8mm glass | | 10mm glass | |
| or Pergotop sandwich panels | | Colour and thickness | | | |
| | | White/white | | 16mm | |
| | Slate/white | | 32mm | | |
| Pergotop-Soft sandwich panels | Tile/white | | Acoustic | | |
| Gutter | Classic | Softline | | | |
| | | | | | |
| Options | LED lighting under the gutter | for switch (not provided by Skylux) | | | |
| | | with remote control | | | |
| | Climaled (3 spotlights/rafter) (quantity -> min. 2) | 2800K - warm | | | → please fill in how many |
| | | 4000K - cold | | | → please fill in how many |
| | Triangle profile and/or windbreak (side panels) | | | | → see order form triangle profile and windbreak |
| | Climaglide (sliding wall system) | | | | → see order form Climaglide |
| Vertical sunblind | | | | → see order form vertical sunblind | |
| Roof sunblind | | | | → see order form roof sunblind | |
| Remarks | | | | | |

* **Standard colours:** no surcharge (delivery time: max. 3 weeks)

** **Trend colours:** € 200 colour change surcharge (delivery time: max. 4 weeks)

*** **Other RAL colours:** + 15 % surcharge + € 200 colour change surcharge (delivery time: max. 4 weeks)
special powder codes on request (+ € 250)

Price inquiry / Order

Climalux Horizon

Customer

Reference – project

Time of delivery

Inquiry

No custom sizes

Order

Please mark your choice with a cross or specify where necessary

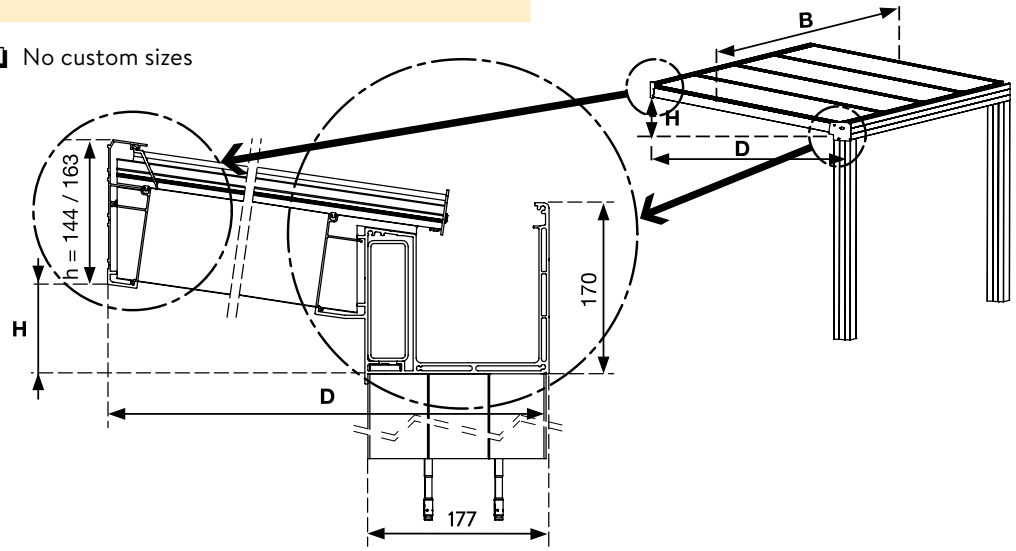

| | | | | | |
|-------------------------------|--|-------------------------------------|----------------------------|------------------------------------|---|
| Dimensions (in mm) | Width 'B' | | | | |
| | Depth 'D' (outer side of post) | | | | |
| | Height difference 'H' or inclination (between 2° and 10° and from 5° when using multi-walled sheets) | | | | |
| | Post length (150 x 177mm) | 2500mm | | 3250mm | |
| | Or customised posts (exact length) | | | | |
| Standard colours* | RAL 9010 white | | | | |
| | RAL 7016 ST anthracite (Tiger 029/71334) | | | | |
| Trend colours** | RAL 3004 ST purple red (AE03053300420) | | Other RAL colour*** | RAL | |
| | RAL 7039 ST (AE03057703920) | | Powder code | | |
| | RAL 8014 ST (AE030588001420) | | Type | Gloss | |
| | RAL 9001 cream | | | Textured | |
| | RAL 9005 ST cream (Axalta AE3054900520) | | | Matte (30 % gloss) | |
| | RAL 9006 ST silver grey (Tiger 029/90146) | | | | |
| | RAL 9007 ST grey aluminium (Tiger 029/90147) | | | | |
| | RAL 9009 ST DB 703 (Tiger 029/80077) | | | | |
| RAL 9010 ST (AE03059901020) | | | | | |
| Sheet type | Polycarbonate/Plexiglas | Type | | | |
| | | 16mm thick | | clear | |
| | | 32mm thick | | opal | |
| | Glass (maximum 750mm glass width) | 8mm glass | | 10mm glass | |
| | | Colour and thickness | | | |
| | | or Pergotop sandwich panels | White/white | | 16mm |
| Pergotop-Soft sandwich panels | Slate/white | | 32mm | | |
| | Tile/white | | Acoustic | | |
| Type | Freestanding roof (installation against GDZ) | | | | |
| Options | LED lighting under the gutter | for switch (not provided by Skylux) | | | |
| | | with remote control | | | |
| | Climaled (3 spotlights/rafter) (quantity -> min. 2) | 2800K – warm | | | → please fill in how many |
| | | 4000K – cold | | | → please fill in how many |
| | Triangle profile and/or windbreak (side panels) | | | | → see order form triangle profile and windbreak |
| | Climaglide (sliding wall system) | | | | → see order form Climaglide |
| Vertical sunblind | | | | → see order form vertical sunblind | |
| Roof sunblind | | | | → see order form roof sunblind | |
| Remarks | | | | | |

* **Standard colours:** no surcharge (delivery time: max. 3 weeks)

** **Trend colours:** € 200 colour change surcharge (delivery time: max. 4 weeks)

*** **Other RAL colours:** + 15 % surcharge + € 200 colour change surcharge (delivery time: max. 4 weeks)
special powder codes on request (+ € 250)

Price inquiry / Order

Climacrown

Customer

Reference – project

Time of delivery

Inquiry

No custom sizes

Order

Please mark your choice with a cross or specify where necessary

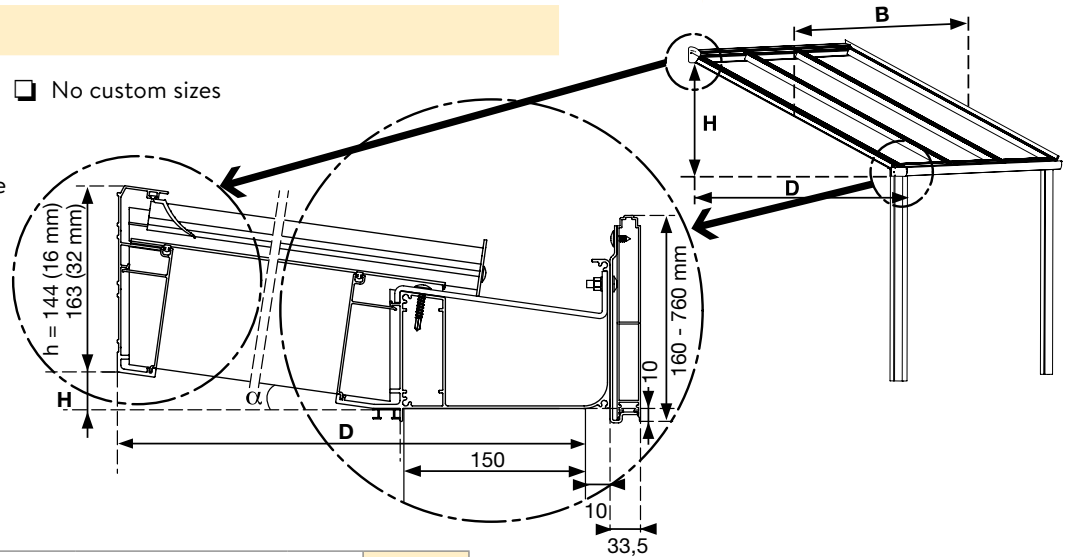

| | | | | | |
|---------------------------|--|-------------------------------------|----------------------------|--------------------------------|---|
| Dimensions (in mm) | Width 'B' | | | | |
| | Depth 'D' (outer side of post) | | | | |
| | Height difference 'H' or inclination (between 2° and 10° and from 5° when using multi-walled sheets) | | | | |
| | Post length (150 x 150mm) | 2500mm | | 3250mm | |
| | Or customised posts (exact length) | | | | |
| | Side walls | Left | | Right | |
| Standard colours* | RAL 9010 white | | | | |
| | RAL 7016 ST anthracite (Tiger 029/71334) | | | | |
| Trend colours** | RAL 3004 ST purple red (AE03053300420) | | Other RAL colour*** | RAL | |
| | RAL 7039 ST (AE03057703920) | | Powder code | | |
| | RAL 8014 ST (AE030588001420) | | Type | Gloss | |
| | RAL 9001 cream | | | Textured | |
| | RAL 9005 ST black (Axalta AE3054900520) | | | Matte (30 % gloss) | |
| | RAL 9006 ST silver grey (Tiger 029/90146) | | | | |
| | RAL 9007 ST grey aluminium (Tiger 029/90147) | | | | |
| | RAL 9009 ST DB 703 (Tiger 029/80077) | | | | |
| | RAL 9010 ST (AE03059901020) | | | | |
| Sheet type | Polycarbonate/Plexiglas | Type | | | |
| | | 16mm thick | | clear | |
| | | 32mm thick | | opal | |
| | Glass (maximum 750mm glass width) | 8mm glass | | 10mm glass | |
| | | Colour and thickness | | | |
| | | White/white | | 16mm | |
| or | Pergotop sandwich panels | Slate/white | | 32mm | |
| | Pergotop-Soft sandwich panels | Tile/white | | Acoustic | |
| Type | Freestanding roof (installation against GDZ) | | | | |
| Options | LED lighting under the gutter | for switch (not provided by Skylux) | | | |
| | | with remote control | | | |
| | Ledverlichting onder Climacrown | | | | |
| | Climaled (3 spots/rafter) (quantity -> min. 2) | 2800K - warm | | | → please fill in how many |
| | | 4000K - cold | | | → please fill in how many |
| | Triangle profile and/or windbreak (side panels) | | | | → see order form triangle profile and windbreak |
| | Climaglide (sliding wall system) | | | | → see order form Climaglide |
| | Vertical sunblind | | | | → see order form vertical sunblind |
| Roof sunblind | | | | → see order form roof sunblind | |
| Remarks | | | | | |

* **Standard colours:** no surcharge (delivery time: max. 3 weeks)

** **Trend colours:** € 200 colour change surcharge (delivery time: max. 4 weeks)

*** **Other RAL colours:** +15 % surcharge + € 200 colour change surcharge (delivery time: max. 4 weeks)
special powder codes on request (+ € 250)

Price inquiry / Order

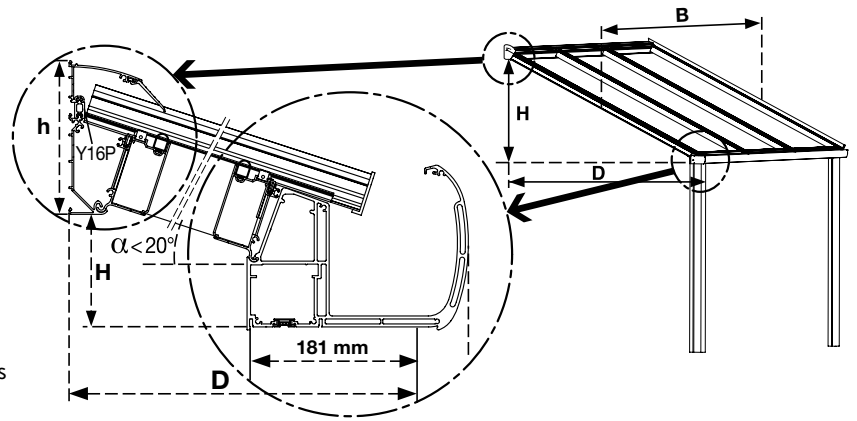

Climax Panorama

| |
|---------------------|
| Customer |
| Reference – project |
| Time of delivery |

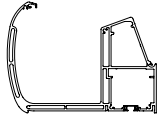
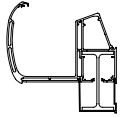

- Inquiry No custom sizes
 Order

Please mark your choice with a cross or specify where necessary.

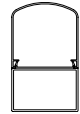
| | | | | |
|-------------------------------|---|---|---|---|
| Dimensions (in mm) | Width 'B' | | | |
| | Depth 'D' (outer side of post) | | | |
| | Height difference 'H' or inclination ($2^\circ < x < 20^\circ$) | | | |
| | Post length | 2500mm | 3250mm | |
| | Or customised posts (exact length) | | | |
| Standard colours* | RAL 9010 white | | | |
| | RAL 7016 ST anthracite (Tiger 029/71334) | | | |
| Trend colours** | RAL 3004 ST purple red (AE03053300420) | | Other RAL colour*** | RAL |
| | RAL 7039 ST (AE03057703920) | | Powder code | |
| | RAL 8014 ST (AE030588001420) | | Type | Gloss |
| | RAL 9001 cream | | | Textured |
| | RAL 9005 ST black (Axalta AE3054900520) | | | Matte (30 % gloss) |
| | RAL 9006 ST silver grey (Tiger 029/90146) | | | |
| | RAL 9007 ST grey aluminium (Tiger 029/90147) | | | |
| | RAL 9009 ST DB 703 (Tiger 029/80077) | | | |
| | RAL 9010 ST (AE03059901020) | | | |
| Sheet type | Polycarbonate/Plexiglas | | Type | |
| | | | 16mm thick | clear |
| | Glass connection profile | | 32mm thick | opal |
| | Glass (max. 750mm glass width) | | 8mm glass | 10mm glass |
| | | | Colour and thickness | |
| | or Pergotop sandwich panels | | White/white | 16mm |
| Pergotop-Soft sandwich panels | | Slate/white | 32mm | |
| | | Tile/white | Acoustic | |
| Finish | Rubber seals | | | |
| | Aluminium clips CL16/CL32 | | | |
| | Screw-on clips CLSB/CLST | | | → recommended for glass |
| Gutter | GDG + GDGL | | GDG + GDGK + IPE120 steel reinforcement | |
| |  | |  | |
| Post | Post 110/72 (without clip) | | Post 110/181 (with clip) | |
| |  | |  | |
| Type | Freestanding roof (installation against GDG) | | | |
| Options | LED lighting under the gutter | for switch (not provided by Skylux) with remote control | | |
| | Climaled (3 spotlights/rafter) (quantity -> min. 2) | 2800K - warm | | → please fill in how many |
| | | 4000K - cold | | → please fill in how many |
| | Triangle profile and/or windbreak (side panels) | | | → see order form triangle profile and windbreak |
| | Climaglide (sliding system) | | | → see order form Climaglide |
| | Vertical sunblind | | | → see order form vertical sunblind |
| Roof sunblind | | | → see order form roof sunblind | |
| Remarks | | | | |

* **Standard colours:** no surcharge (delivery time: max. 3 weeks)
 ** **Trend colours:** € 200 colour change surcharge (delivery time: max. 4 weeks)
 *** **Other RAL colours:** + 15 % surcharge + € 200 colour change surcharge (delivery time: max. 4 weeks)
 special powder codes on request (+ € 250)

Price inquiry / Order

Climax

| |
|---------------------|
| Customer |
| Reference - project |
| Time of delivery |

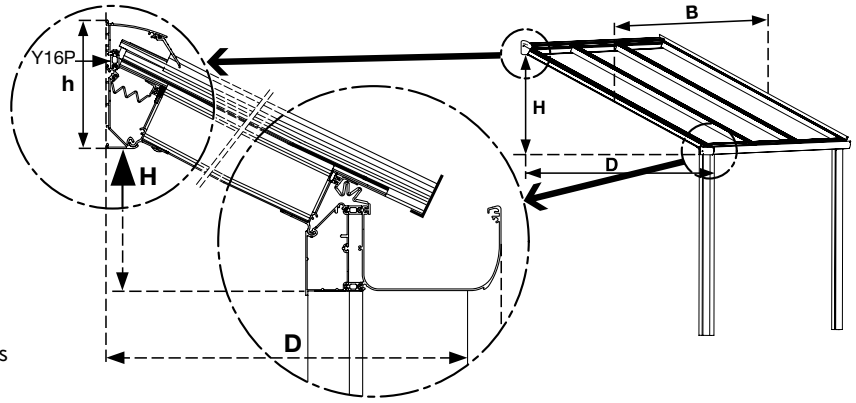

- Inquiry No custom sizes
 Order

Please mark your choice with a cross or specify where necessary.

| | | | | |
|---------------------------|--|-----------------------------|---------------------------------|---|
| Dimensions (in mm) | Width 'B' | | | |
| | Depth 'D' (outer side of post) | | | |
| | Height difference 'H' or inclination (between 5° and 45°) | | | |
| | Post length | 2500mm | 3250mm | |
| Profiles | Cut to size* | | | |
| Type | Cold (without thermal break) | | | |
| | Warm (with thermal break) | | | |
| Installation | Against 1 wall | | | |
| | Against 1 wall and 1 side wall | | | |
| | Against 1 wall and 2 side walls | | | |
| | Between 4 walls | | | |
| | Installed on frames | | | |
| Standard colours* | RAL 9010 white | | | |
| | RAL 7016 ST anthracite (Tiger 029/71334) | | | |
| Trend colours** | RAL 3004 ST purple red (AE03053300420) | | Other RAL colour*** | RAL |
| | RAL 7039 ST (AE03057703920) | | | Powder code |
| | RAL 8014 ST (AE030588001420) | | Type | Gloss |
| | RAL 9001 cream | | | Textured |
| | RAL 9005 ST black (Axalta AE3054900520) | | | Matte (30 % gloss) |
| | RAL 9006 ST silver grey (Tiger 029/90146) | | | |
| | RAL 9007 ST grey aluminium (Tiger 029/90147) | | | |
| | RAL 9009 ST DB 703 (Tiger 029/80077) | | | |
| | RAL 9010 ST (AE03059901020) | | | |
| Finish | Rubber seals | | | |
| | Aluminium clips CL16/CL32 | | | |
| | Screw-on aluminium clips CLSB and CLST (recommended for glass) | | | |
| Sheet type | Multi-walled acrylic | | Type | |
| | Multi-walled polycarbonate | | Type | |
| | | | Colour & Thickness | Clear 16mm |
| | | | | Opal 32mm |
| | | | | Heat reflecting |
| | or Pergotop sandwich panels | | Colour & Thickness | White/white 16mm |
| | Pergotop soft sandwich panels | | | Slate/white 32mm |
| | | | | Tile/white Acoustic |
| | or Glass thickness (in mm) | | Gutter support | Self-supporting |
| | Number of glass sheets (max. 750mm glass width) | | | Posts |
| Glass connection profile | | Gutter support bracket | | |
| Post | Posts without thermal break | post 50/100 | Gutter support brackets & posts | |
| | | post 100/100 | | |
| | | post 110/100 (without clip) | | |
| | Posts with thermal break | post 110/181 (with clip) | Gutter | Installation without gutter (hinge bottom SB) |
| | | post 110/116 (without clip) | | Climax gutter (G+GD) |
| | | post 110/197 (with clip) | | Raised profile for gutter (GR) |
| | | | Drainpipe set | |
| Options | Triangle profile (only for cold application) | | 1 | 2 |
| | Climaled (rafters - minimum 2 pieces) - spotlights | | 2800K - warm | |
| | | | 4000K - cold | |
| | Climaglide (sliding wall system) (only for cold application) | | Front side | Side wall |
| Remarks | | | | |

* **Standard colours:** no surcharge (delivery time: max. 3 weeks)
 ** **Trend colours:** € 200 colour change surcharge (delivery time: max. 4 weeks)
 *** **Other RAL colours:** + 15 % surcharge + € 200 colour change surcharge (delivery time: max. 4 weeks)
 special powder codes on request (+ € 250)

Price inquiry / Order

Pergolux

| |
|---------------------|
| Customer |
| Reference – project |
| Time of delivery |

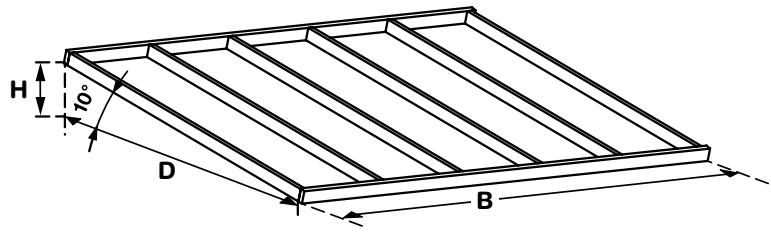

- Inquiry
 Order

Please mark your choice with a cross or specify where necessary.

- Alu-series** system with aluminium profiles and standard grey coex rubber seals
Color-series system with powdercoated aluminium profiles with white or grey coex rubber seals
Therm-series system with thermal break and white coextruded PVC clips
Color-Therm-series system with thermal break and powdercoated aluminium clips
Color-Therm Glass-series system with thermal break for sheets or glass with screw-on aluminium clips, glass thickness between 8mm and 34mm

| | | | | |
|---------------------------|--|---------------------------|-------------------------|---------------------|
| Dimensions (in mm) | Width 'B' | | | |
| | Depth 'D' (outer side of the construction at wall side) | | | |
| | Height difference 'H' or inclination (10° as standard) | | | |
| | or Length sheets & profiles | | | |
| | Finish | Aluminium (mill finished) | | |
| Color | | → RAL 9010 white | | |
| Therm | | → RAL 9010 white | | |
| Color-Therm | | → RAL 9010 white | RAL 7016 ST anthracite* | |
| Color-Therm Glass | | → RAL 9010 white | RAL 7016 ST anthracite* | |
| | | or Non-standard RAL** | | |
| | | RAL | | |
| | Type | Gloss | | |
| | | Matte (30 % gloss) | | |
| | | Textured | | |
| Sheet type | Multi-walled acrylic | | Type | |
| | Multi-walled polycarbonate | | Type | |
| | | | Colour & thickness | Clear 16mm |
| | | | | Opal 32mm |
| | | | | Heat-reflective |
| | or Pergotop sandwich panels | | Colour & thickness | White/white 16mm |
| | Pergosoft sandwich panels | | | Slate/white 32mm |
| | Pergotop-Soft sandwich panels | | | Tile/white Acoustic |
| | or Glass thickness (in mm) | | | |
| | Number of glass sheets (max. 750mm glass width) | | | |
| Gutter | No gutter | | | |
| | Gutter G120A | | | |
| | Gutter G (only for Color-Therm Glass-series) | | | |
| | Raised profile for gutter (GR) | | | |
| Options | Drainpipe set | | | |
| Remarks | | | | |

* Outside RAL 7016 ST – inside RAL 9010 white

** Non-standard RAL colours are only possible in case of Color-Therm Glass. Delivery time is max. 4 weeks

Price inquiry / Order

Climaglide

| |
|---------------------|
| Customer |
| Reference – project |
| Time of delivery |

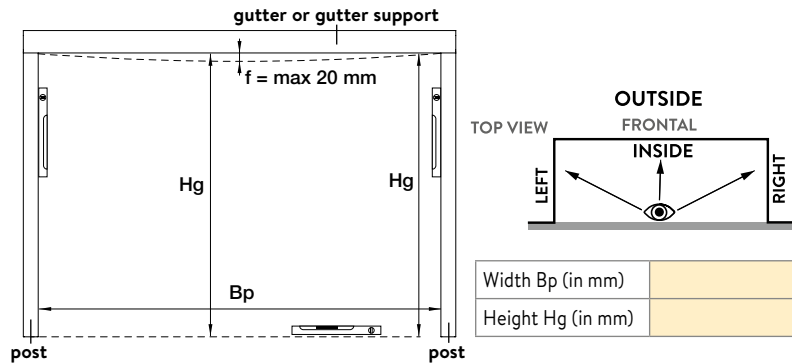

- Inquiry
 Order

Please mark your choice with a cross or specify where necessary.

Measuring your sliding glass door

Make sure the opening is perfectly perpendicular. The sill in which the lower rail is screwed must be perfectly level so the sliding partition system can work properly. If the deflection of the upper profile (gutter) is more than 20mm, the sliding glass door cannot be installed. Bear in mind that the lower and upper rails are X times 20mm wide. A system with 3 tracks is therefore 60mm wide. The pole on the parking side against which the sliding glass door is installed must at least have the same depth.

Dimensions

Measure the width (Bp) between the posts. Measure the height (Hg) from sill to gutter and check whether this corresponds to the ordered sliding glass door. The height (Hg) in the middle of the opening and at the side may differ by a maximum of 20mm. Bear in mind that the deflection of the gutter may be larger when loaded with snow. The maximum height Hg is 2350mm for the 8mm model. For a 10mm model, the maximum height Hg is 2620mm in case of a double system or 3000mm in case of a single system.

System & opening direction (as seen from the inside to the outside)

| | | |
|--|--|---|
| 3 tracks & 3 glass elements | 4 tracks & 4 glass elements | 5 tracks & 5 glass elements |
| park side left | park side left | park side left |
| park side right | park side right | park side right |
| 3 tracks & 6 glass elements | 4 tracks & 8 glass elements | 5 tracks & 10 glass elements |
| park side left and right | park side left and right | park side left and right |

| | Quantity |
|-------------------------|---|
| Type | Climaglide 8mm basic* |
| | Climaglide 8mm separate sliding elements |
| | Climaglide 10mm carrier system |
| Colour | RAL 9010 |
| | RAL 7016 ST |
| | Trend colour |
| | Non-standard RAL colour |
| Extra (optional) | Screw-on double handle D68/60 (in RVS) |
| | Screw-on double handle D68/60 (anodised aluminium) |
| | Set of 2 anodised self-adhesive handles |
| | Painted aluminium profile with sealing brush (# pieces) |
| | Sealing brush transparent PVC |
| | Transparent glass glue for sealing brushes (200ml) |

* system without side wall profiles, without latch block and without end pieces

(€ 200 colour change surcharge)
 (€ 200 colour change surcharge + 15% surcharge)

Price inquiry / Order

Triangle / Windbreak

| |
|---------------------|
| Customer |
| Reference – project |
| Time of delivery |

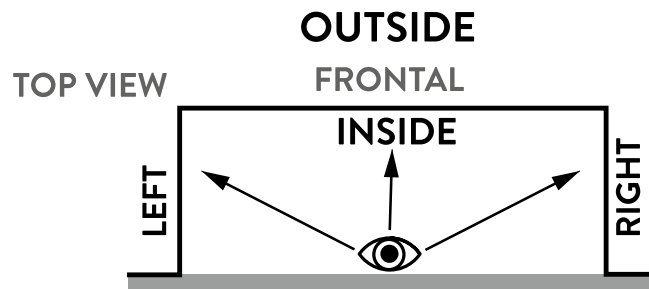

- Inquiry
- Order

Please mark your choice with a cross or specify where necessary.

| | | | | |
|----------------------------|--|--|-----------------------------|------|
| Dimensions (in mm) | Width 'B' | | | |
| | Depth 'D' (to the inside of the gutter/post) | | | |
| | Height difference 'H' or inclination | | | |
| | Post length | | | |
| | Colour (and powder code) | | | |
| CROSSBEAM P72 | LEFT | | RIGHT | |
| TRIANGLES | Customised profiles | | | |
| | | | CLEAR | OPAL |
| Glazing triangle | Single-pane safety glass 10mm (not included) | | Polyclear SPC16.3U 2UV | |
| | Glass 16mm (not included) | | Polyclear 3W 16/32 | |
| | Pergotop RAL 9010 | | Polyclear Top-X 5X | |
| | Pergotop RAL 7016 ST | | Polyclear Top-X 6X | |
| | | | Polyclear Reflex Pearl 16 | |
| | | | Polyclear Primalite 16 | |
| | | | Plexiglas Resist S2P 16/64 | |
| | LEFT | | RIGHT | |
| Partition triangle | No triangle | | No triangle | |
| | Triangle without partition | | Triangle without partition | |
| | Triangle in 2 parts | | Triangle in 2 parts | |
| | Triangle in 3 parts | | Triangle in 3 parts | |
| | Triangle in 4 parts | | Triangle in 4 parts | |
| | Triangle in 5 parts | | Triangle in 5 parts | |
| | Triangle in 6 parts | | Triangle in 6 parts | |
| WINDBREAK | Customised profiles | | | |
| | | | CLEAR | OPAL |
| Glazing windbreak | Single-pane safety glass 10mm (not included) | | Polyclear SPC16.3U 2UV | |
| | Glass 16mm (not included) | | Plexiglas Resist S2P 16/64 | |
| | Pergotop RAL 9010 | | | |
| | LEFT | | RIGHT | |
| Partition windbreak | No windbreak | | No windbreak | |
| | Windbreak without partition | | Windbreak without partition | |
| | Windbreak in 2 parts | | Windbreak in 2 parts | |
| | Windbreak in 3 parts | | Windbreak in 3 parts | |
| | Windbreak in 4 parts | | Windbreak in 4 parts | |
| | Windbreak in 5 parts | | Windbreak in 5 parts | |
| | Windbreak in 6 parts | | Windbreak in 6 parts | |

Price inquiry / Order

Vertical sunblind

| |
|---------------------|
| Customer |
| Reference – project |
| Time of delivery |

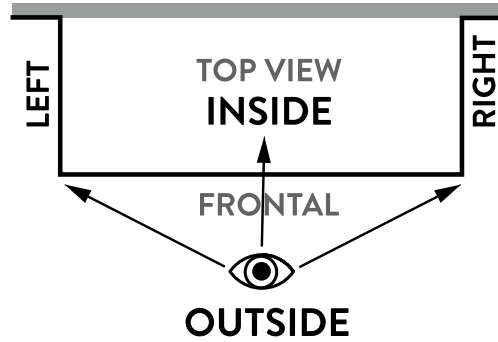

Inquiry Order

Please mark your choice with a cross or specify where necessary

| VERTICAL SUNBLIND | | LEFT | FRONT | RIGHT |
|--|---|------|-------|-------|
| Dimensions | Built-in width (1000 - 6000mm) | | | |
| | Built-in height (2000 - 3000mm) | | | |
| Screen type | AXIOM 100 NON SOLAR (max. width 4000mm) | | | |
| | AXIOM 100 SOLAR (max. width 4000mm) | | | |
| | AXIOM 100 OBSTACLE DETEC (max. width 4000mm) | | | |
| | AXIOM 130 NON SOLAR (max. width 6000mm) | | | |
| | AXIOM 130 SOLAR (max. width 5000mm) | | | |
| | AXIOM 130 OBSTACLE DETEC (max. width 6000mm) | | | |
| | ELEMENT 105 NON SOLAR (max. width 4500mm) | | | |
| | ELEMENT 105 SOLAR (max. width 4500mm) | | | |
| Installation | ELEMENT 105 MANUAL (max. width 4500mm) | | | |
| | Number of sunblinds | | | |
| | Cable position (see image 1) / Winding rod position and length (1.2 / 1.4 / 1.6 / 1.8m) | | | |
| Screen fabric | Inside mount | | | |
| | Outside mount (width + guides and height + casing) | | | |
| Cristal window (see image 2) | Type 1* | | | |
| | Type 2 | | | |
| Control AXIOM | h1 (type 1/2) | | | |
| | hv max. 1350mm (type 1/2) | | | |
| | bv max. 4350mm (type 1/2) | | | |
| | Somfy - Situio 1 io pure II (1 channel remote control) | | | |
| | Somfy - Situio 5 io pure II (4 channels + group remote control) | | | |
| | Somfy Smoove origin 1 io (1 channel wireless wall switch) | | | |
| Control ELEMENT | Somfy Smoove origin 4 io (4 channels wireless wall switch) | | | |
| | Tahoma switch (Smart Home Hub) | | | |
| | Somfy - Eolis WireFree io (wireless wind sensor) | | | |
| | 1 channel remote control | | | |
| Options AXIOM | 2 channels remote control | | | |
| | None | | | |
| | Solar sensor Sunis Wirefree io (wireless) | | | |
| | Wind sensor Eolis Wirefree io (wireless) | | | |
| | Solar and wind sensor Soliris io (230V) | | | |
| | Solar and wind sensor Soliris io + rain sensor Ondeis (230V) | | | |

Image 1 - cable position

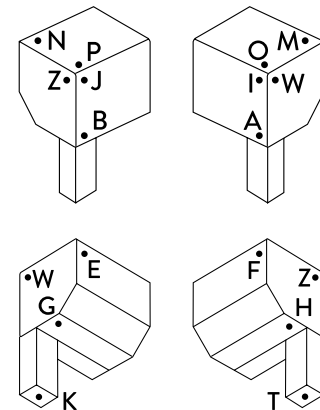

* only possible with a max. width of 4000mm

Image 2 - Cristal windows

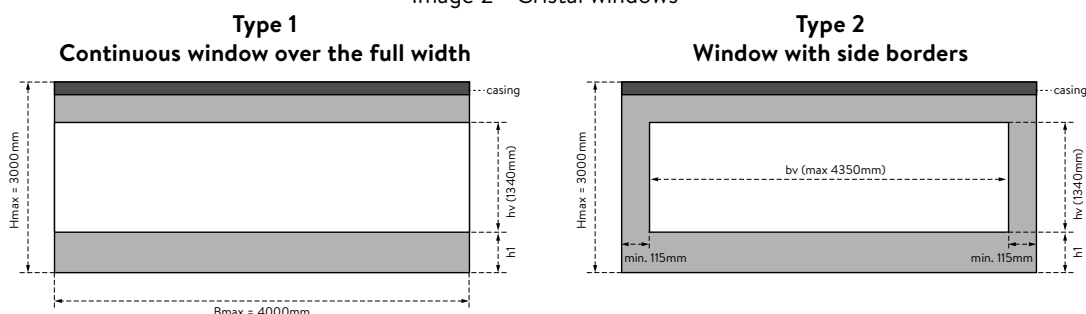



Price inquiry / Order

Roof sunblind

| |
|---------------------|
| Customer |
| Reference – project |
| Time of delivery |

Inquiry Order

Please mark your choice with a cross or specify where necessary

| ROOF SUNBLIND | | | | | |
|-------------------|--|--|--|--------|-------|
| Type | Screen above the roof with ZIP iO (3m cable) | | | | |
| | Screen above the roof without ZIP Somfy iO (3m cable incl.) | | | | |
| | Screen under the roof with ZIP Somfy iO (3m cable incl.) | | | | |
| Colour | RAL + powder code | | | | |
| Fabric | Fabric type / code | | | | |
| | |  Stand-alone |  Connected screens | | |
| | | | Left | Middle | Right |
| Dimensions | Screen width = B-9mm (1950 - 6000mm) Unrolls up to (1000 - 4000* / 4500** / 6000mm) | | | | |
| Quantity | Number of screens | | | | |
| Actuator | Cable position (3m) Left or Right (seen from above) | | | | |
| Control | None | | | | |
| | Somfy - Situ0 1 io Pure II (remote control 1 channel) | | | | |
| | Somfy - Situ0 5 io Pure II (remote control 4 channels + group) | | | | |
| | Somfy - Smooove origin 1 io (wall switch 1 channel) | | | | |
| | Somfy - Smooove origin 4 io (wall switch 4 channels) | | | | |
| Options | None | | | | |
| | Somfy Sunis wirefree io (wireless solar sensor) | | | | |
| | Somfy Eolis wirefree io (wireless wind sensor) | | | | |
| | Solar and wind sensor (wired) | | | | |
| | Rain, solar and wind sensor (wired) | | | | |

Cable position Left or Right (seen from above)



SCREEN ABOVE THE ROOF

* small casing - unrolls ≤ 4000mm

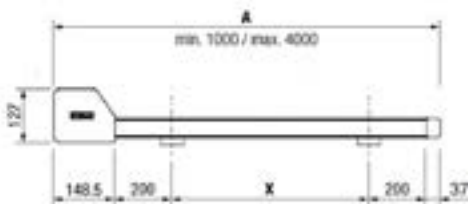

large casing - unrolls > 4000mm to 6000mm

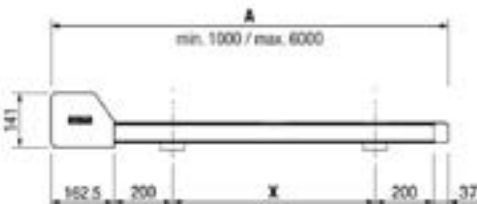

SCREEN UNDER THE ROOF

** casing for B ≤ 6000mm or unrolls ≤ 4500mm

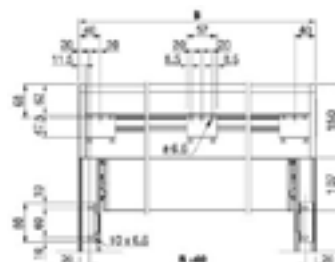
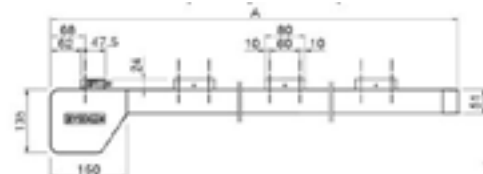

Demo material

| Art.n° | Description | Price (net) |
|---------|--|-------------|
| ① 28990 | Pergolux Color-Therm on pedestal + LED | € 200 |
| ② 27613 | Pergolux Alu on pedestal + LED | € 200 |
| ③ 26207 | Pergolux case | € 80 |
| ④ 26208 | Pergolux D-series case | € 80 |
| ⑤ 18716 | Pergolux Alu display model | € 110 |
| ⑥ 18719 | Pergolux Color-Therm display model | € 110 |
| ⑦ 25096 | Pergolux Color-Therm Glass display model | € 110 |
| ⑧ 78687 | Climalux Horizon display model | € 350 |
| ⑨ 30242 | Climax Panorama + LED on pedestal | € 350 |
| ⑩ 27612 | Climax + LED on pedestal | € 350 |
| ⑪ 35726 | Climalux + LED on pedestal | € 350 |
| ⑫ 30625 | Climax Panorama case | € 75 |
| ⑬ 21834 | Climax case | € 75 |
| ⑭ 35566 | Climalux case | € 75 |
| ⑮ 79079 | Climalux Horizon case | € 75 |
| ⑯ 26210 | Polyclear case | € 75 |
| ⑰ 41664 | Climax Panorama GDG + static | € 75 |
| ⑱ 46155 | Climaled display model | € 30 |
| ⑲ 51090 | Veranda accessories case | € 75 |
| ⑳ 62185 | Roll Up Banner Climax/Climalux (EN) | on request |
| ㉑ 61552 | Display veranda showroom | € 300 |





Table with 2 columns and 30 rows, all cells are empty.



info@skylux.be
www.skylux.eu