



PRICE LIST 01-03-2023

# Veranda systems



# Contents

## PROFILE SYSTEMS

p. 5

Overview (RAL) colours  
for the profile systems

p. 8

### SELF-SUPPORTING NON-THERMAL

#### PROFILE SYSTEM (cold roof)

p. 10

#### CLIMALUX

p. 10

Quick calculator Climalux

without roof overhang

p. 12

Quick calculator Climalux

without roof overhang freestanding roof

p. 14

Quick calculator Climalux standard roofs

without roof overhang

p. 16

Quick calculator Climalux with roof overhang

p. 18

#### CLIMALUX HORIZON

p. 20

Quick calculator Climalux Horizon

p. 22

Quick calculator Climalux Horizon

freestanding roof

p. 24

#### CLIMACROWN ROOF (cold roof)

p. 26

Quick calculator Climacrown

p. 28

Quick calculator Climacrown

freestanding roof

p. 30

#### CLIMAX PANORAMA (cold roof)

p. 32

Quick calculator Climax Panorama

p. 34

Quick calculator Climax Panorama with

IPE120 steel reinforcement in the gutter

(standard colour & 5° pitch)

(IPE120 not included in the price)

p. 36

Quick calculator Climax Panorama

p. 38

freestanding roof

p. 38

### SELF-SUPPORTING THERMAL

#### PROFILE SYSTEM (warm roof)

p. 40

#### CLIMAX

p. 40

Quick calculator Climax thermal

p. 42

Price list profiles and accessories for Climax,

Climalux, Climacrown, Triangle, Windbreak,

Climaglide and Vertical Sunblind

p. 44

### ACCESSORIES FOR SELF-SUPPORTING

#### PROFILE SYSTEMS

p. 64

#### TRIANGLE

p. 64

#### WINDBREAK

p. 65

#### CLIMAGLIDE

p. 66

#### VERTICAL SUNBLIND

p. 68

#### CLIMALED

p. 74

### NON-SELF-SUPPORTING

#### PROFILE SYSTEMS

p. 75

#### PERGOLUX

p. 75

Price list Pergolux D-series

p. 76

Standard series

p. 78

Price list Pergolux

p. 80

---

**OUR PLASTIC SHEETS  
FOR VERANDA SYSTEMS**

p. 90

Polyclear

p. 90

PLEXIGLAS®

p. 92

Pergotop – Pergotop-Soft

p. 93

---

**DEMO MATERIAL**

p. 94



## Useful information for quick rate use

A patio roof offers a perfect solution for extending your home. Our range consists of both non-self-supporting profiles for use on a timber structure and of self-supporting aluminium profiles.

### Self-supporting or non-self-supporting (p. 10-89)

Self-supporting profile systems (p. 10-74) require no extra support from wood or metal. We offer a wide selection through Climalux, Climalux Horizon, Climacrown, Climax and Climax Panorama.

The non-self-supporting systems (p. 75-89) are supported by timber or metal joists. Our range of Pergolux systems offers a wide selection of possibilities for any type of glazing.

### Thermal or non-thermal

Thermal profiles are ideal for closed structures. These profiles are thermally insulated and prevent condensation. Among the self-supporting systems, the Climax roof offers these thermal qualities, as do the Pergolux Therm, Pergolux Color-Therm and Pergolux Color-Therm Glass among the non-self-supporting systems.

Non-thermal profiles are suitable for open structures where there is no temperature difference between the inside and outside areas, as with verandas. The self-supporting systems Climalux, Climalux Horizon, Climacrown, Climax non-thermal and Climax Panorama can be used for this purpose. For non-self-supporting applications, the Pergolux series Alu and Color and the D series offer a good solution.

### Glazing

Our veranda roofs can be fitted with multi-walled plastic sheets – 16 or 32mm thick – in polycarbonate (Polyclear) or acrylic (PLEXIGLAS®) and/ or glass – 8 or 10mm thick laminated glass or thermal glass up to a maximum of 34mm thick – and/or sandwich panels (Pergotop-Soft).

### Broad range of options

Apart from traditional rectangular pitched roofs, our systems also offer the possibility of implementing L shaped or differently shaped roofs (roofs around a corner, a recess for a balcony, etc.) or also applications with sloping sides. Certain systems can also be used to construct a gable roof.

### Colours

Skylux patio roofs are available in different RAL colours. See pages 8-9.

### Price lists

**This price list is published yearly. Any intermediate price changes are updated in the online version of this price list (see [www.skylux.eu](http://www.skylux.eu)).**

### Components price list

You will find a complete list with names, drawings and prices for all Pergolux parts and accessories: see p. 80-89. For a more detailed list of parts and accessories for all self-supporting systems: see p. 44-63.

### Quick price calculator

This price list also contains 'quick calculators' for a number of veranda roofing systems. They enable you to quickly know the price for a number of standard sizes in a particular combination of profiles. **Please note: these prices are indicative and not binding. The plastic sheets are not included in the price.** You will find these quick price calculators on the following pages:

- Climalux: p. 12-19
- Climalux standard roofs: p. 16-17
- Climalux Horizon: p. 22-23
- Climacrown: p. 28-29
- Climax Panorama: p. 34-37
- Climax thermal: p. 42-43

### Tips

**Download our Climafast & Pergofast calculation programmes ([www.skylux.be/calculations](http://www.skylux.be/calculations)) to produce quick and accurate quotations. Use our order forms to place your orders.**

**NEW**

Triangle ..... p. 64  
Windbreak ..... p. 65

## Terms and conditions of sale

- We explicitly refer you to our general terms and conditions of sale, technical sheets and installation manuals.
- Prices are in EUR, gross and excluding VAT.
- Delivery duty paid from EUR 300 net value in Belgium, the Netherlands, Northern France and Germany (Ruhr); transport costs of EUR 50 are charged for deliveries of less than EUR 300 net value.
- This rate supersedes all previous rates.
- This price list was compiled with the utmost care. However, we cannot be held liable for any printing or calculation errors, nor for price fluctuations.
- You will always find the latest prices on our website [www.skylux.eu](http://www.skylux.eu).

# Profile systems

## Self-supporting profile systems

There is a wide and multi-faceted range of self-supporting systems:

- Climalux (p. 10)
- Climalux Horizon (p. 20)
- Climacrown (p. 26)
- Climax Panorama (p. 32)
- Climax thermal (warm) (p. 40)



Ask for our Climafast calculation tool to produce quick quotations

Use our order forms to place your orders.

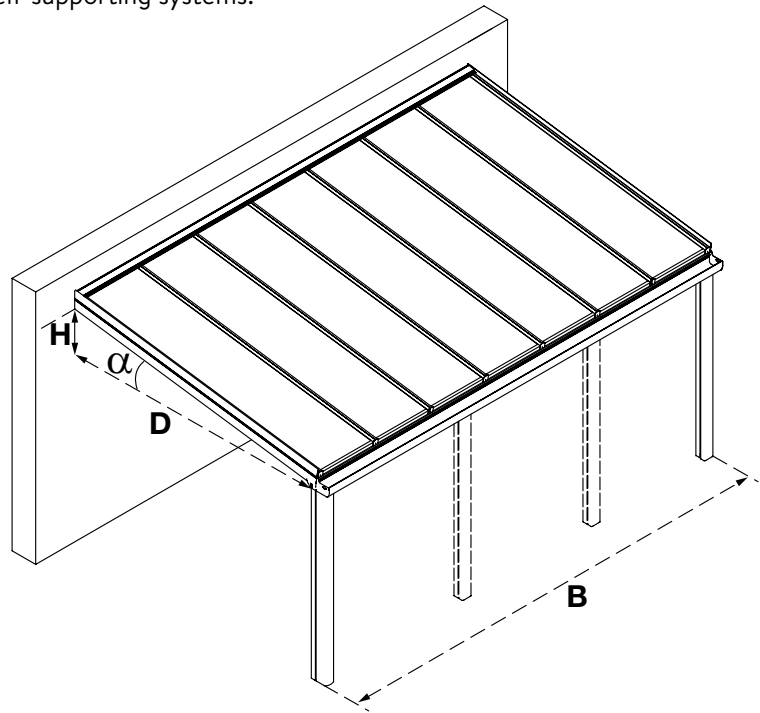

## Non-self-supporting profile systems

We offer a wide range of non-self-supporting profile series under the brand name Pergolux (see p. 51 to 65):

- Pergolux D-Serie (p. 76-77)
- Pergolux standard series (p. 78-79)



Ask for our Pergofast calculation tool to produce quick quotations

Use our order forms to place your orders.

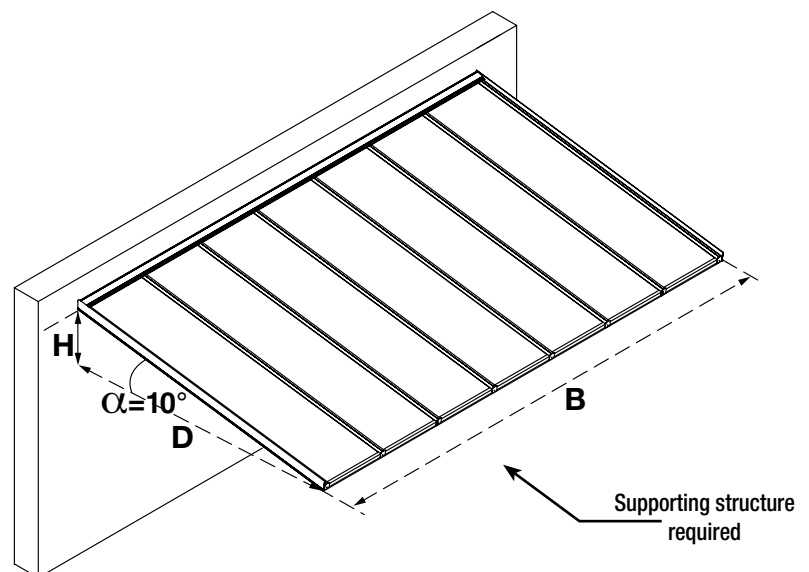

SELF-SUPPORTING

COLD ROOFS  
Non-thermal profile system

CLIMALUX

- profiles made to fit
- some standard sizes are already prepacked in stock
- for 16 and 32mm plastic sheets or 8 and 10mm glass
- maximum depth of 5.5m
- the roof pitch varies between 2° and 10° and starting from 5° with multi-walled sheets
- optional roof overhang
- optional freestanding roof
- optional LED spotlights with mounting profile
- easy installation
- CE certified in accordance with EN 1090-3

CLIMALUX HORIZON

- profiles made to fit
- new gutter for pan lengths up to 6m with just two support posts
- sleek and contemporary design
- for 16 and 32mm plastic sheets or 8 and 10mm glass
- maximum depth of 5.5m
- the roof pitch varies between 2° and 10° and starting from 5° with multi-walled sheets
- optional freestanding roof
- optional LED spotlights with mounting profile
- easy installation
- CE certified in accordance with EN 1090-3

CLIMACROWN

- profiles made to fit
- elegant crown profile on the front and on the sides
- sleek and contemporary design
- for 16 and 32mm plastic sheets or 8 and 10mm glass
- maximum depth 4m
- roof pitch of 2° and starting from 5° with multi-walled sheets
- optional freestanding roof
- optional LED spotlights with mounting profile
- easy installation
- CE certified in accordance with EN 1090-3

NON-SELF-SUPPORTING

COLD ROOFS  
Non-thermal profile system

PERGOLUX ALU

A system with aluminium profiles and standard grey coextruded rubber strip

- extensive range of standard lengths
- for 16mm and 32mm thick plastic sheets
- only available in mill finished aluminium
- variable pitch
- simple construction and installation

PERGOLUX COLOR

A system with coated aluminium profiles and white coextruded rubber strips

- extensive range of standard lengths
- for 16mm and 32mm thick plastic sheets
- variable pitch
- simple construction and installation

PERGOLUX D-SERIES

A system with non-self-supporting aluminium profiles and standard grey coextruded rubber strips

- extensive range of standard lengths
- for 16mm thick plastic sheets or glass (glass only in combination with bottom rubber strips)
- only available in mill finished aluminium
- optional alu covering clips to hide screw heads (also available in white)
- variable pitch
- simple construction and installation

\* SKYLUX PATIO ROOFS ARE AVAILABLE

PROFILE SYSTEMS

HOT ROOFS  
Thermal profile system

CLIMAX PANORAMA

- gutter span up to 7m with just two support posts
- integrated LED lighting in the gutter possible
- profiles made to size and pre-assembled
- for 16 or 32mm thick plastic sheets or for 8 or 10mm thick glass
- maximum depth of 5.5m
- the roof pitch varies between 2° and 20° and starting from 5° with multi-walled sheets
- optional freestanding roof
- option for Climaled profile with LED spotlights under the supports
- various construction methods available
- CE certified in accordance with EN 1090-3

CLIMAX THERMAL

- gutter span up to 7m with just two support posts (when using the raised gutter post GD2)
- profiles made to size and pre-assembled
- for 16 or 32mm plastic sheets or glass up to 34mm thick
- maximum depth 5.5m
- variable pitch from 5° to 45°
- option for Climaled profile with LED spotlights under the supports
- various construction methods available
- CE certified in accordance with EN 1090-3

PROFILE SYSTEMS

HOT ROOFS  
Thermal profile system

PERGOLUX  
COLOR-THERM

Thermal profile system with aluminium clips in coated version

- extensive range of standard lengths
- for 16mm and 32mm thick plastic sheets
- variable pitch
- simple construction and installation

PERGOLUX  
COLOR-THERM GLASS

Thermal profile system for glass with aluminium screw clips

- extensive range of standard lengths
- for glass of 8 to 34mm thick
- variable pitch
- simple construction and installation

IN DIFFERENT RAL COLOURS. SEE PAGES 8-9.

# Overview (RAL) colours for the

## SELF-SUPPORTING PROFILE SYSTEMS

- **Climalux, Climalux Horizon, Climacrown, Climax Panorama and Climax thermal** are available as follows:

→ 2 standard RAL colours



white RAL 9010 (code RWB964)



anthracite RAL 7016 ST (code 029/71334)

Delivery time: max. 3 weeks

→ 8 “trend” RAL colours



cream white RAL 9001 (code AE70019220225)



black RAL 9005 ST (code AE03054900520)



white aluminium RAL 9006 ST (code 029/90146)



grey aluminium RAL 9007 ST (code 029/90147)



RAL 9009 ST (DB703) (code 029/80077)



RAL 9010 ST (code AE03059901020)



purple red RAL 3004 ST (code AE03053300420)



RAL 7039 ST (code AE03057703920)

Surcharge: € 200 net

Delivery time: on request

→ Other RAL colours (\*)

15% surcharge + surcharge of € 200 net

Delivery time: on request

\* For the RAL colours not mentioned in our colour list, there is a 15% surcharge and an additional surcharge of € 445 net. You can consult this colour list with the calculation programme Climafast. The price for all other colour codes is available on request.



# profile systems

## NON-SELF-SUPPORTING PROFILE SYSTEMS

### ● Pergolux Alu



mill finished aluminium

### ● Pergolux D-series



mill finished aluminium

### ● Pergolux Color

→ 1 standard RAL colour



white RAL 9010

### ● Pergolux Color-Therm

→ 3 standard RAL colours



white RAL 9010



brown RAL 8019



RAL 7016 ST (\*\*)

### ● Pergolux Color-Therm Glass

→ 3 standard RAL colours



white RAL 9010



brown RAL 8019



RAL 7016 ST (\*\*)

→ Other RAL colours (\*)

15% surcharge + surcharge of € 200 net

Delivery time: on request

\*\* Only the profiles visible on the outside are delivered in this RAL colour.

The colour display is indicative: there can be a difference between the CMYK display (prints), the RGB display (digital) and the RAL execution (lacquer).

## SELF-SUPPORTING NON-THERMAL PROFILE SYSTEM (cold roof)

### CLIMALUX

Climalux is the basic version of the Climax profile range and is primarily used as a patio roof or canopy. A roof overhang is also possible.

This self-supporting profile system is supplied made-to-measure and can be installed very quickly. The Climalux roof is self-supporting up to 5.5m in width between two posts, with 16mm plastic sheets (with a depth of 3m). It is self-supporting up to 5.5m in depth. The roof pitch varies between 2° and 10° and starting from 5° with multi-walled sheets.

Climalux can be built with or without roof overhang. A roof overhang of maximum 550mm is possible.

- 2 standard RAL colours: white RAL 9010 & anthracite RAL 7016 ST. Delivery time: max. 3 weeks.
- 8 “trend” RAL colours: cream white RAL 9001, black RAL 9005 ST, white aluminium RAL 9006 ST, grey aluminium RAL 9007 ST, RAL 9009 ST (DB703), RAL 9010 ST, purple red RAL 3004 ST & RAL 7039 ST. Surcharge: € 200 net. Delivery time: on request.
- Other RAL-colours: see p. 8 & 9 (price on request). Delivery time: on request.

The Climalux veranda roof can also be installed with 8 to 10mm glass (not supplied by Skylux).

Climalux can also be fitted with Climaled (see p. 74).

**Important: some standard sizes (for multi-walled plastic sheets) are already prepacked in stock and can be delivered within a week of the order date (see p. 16).**



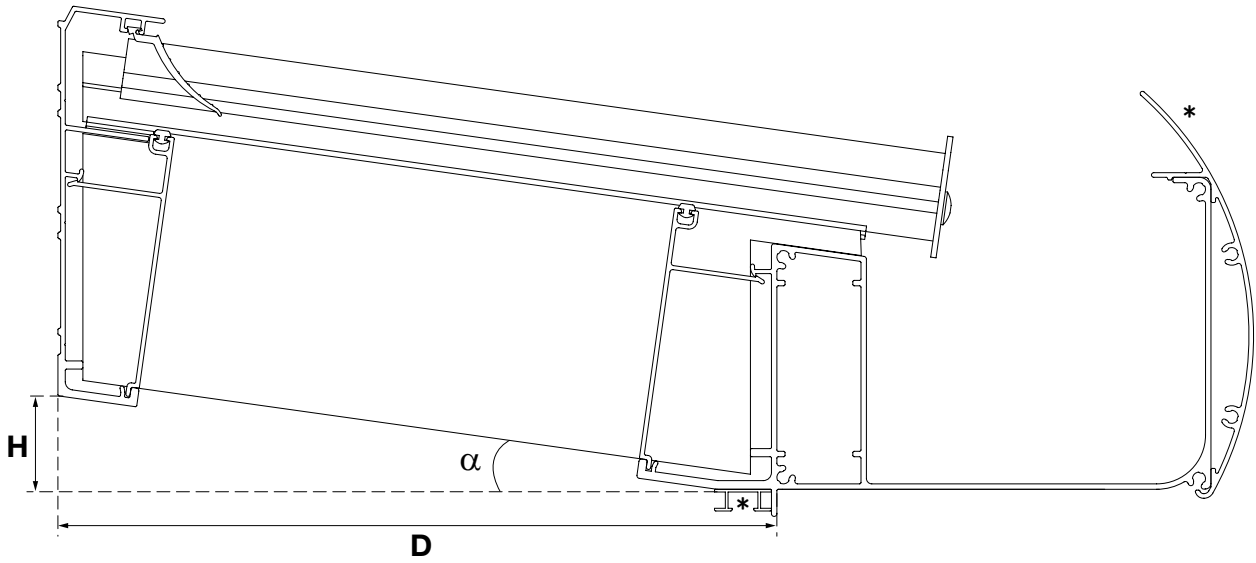

\* Softline gutter top piece and LED Strips optional

### Options

- Width B: ∞
- Depth D: max. 5.5m
- The roof pitch  $\alpha$  varies between 2° and 10° and starting from 5° with multi-walled sheets

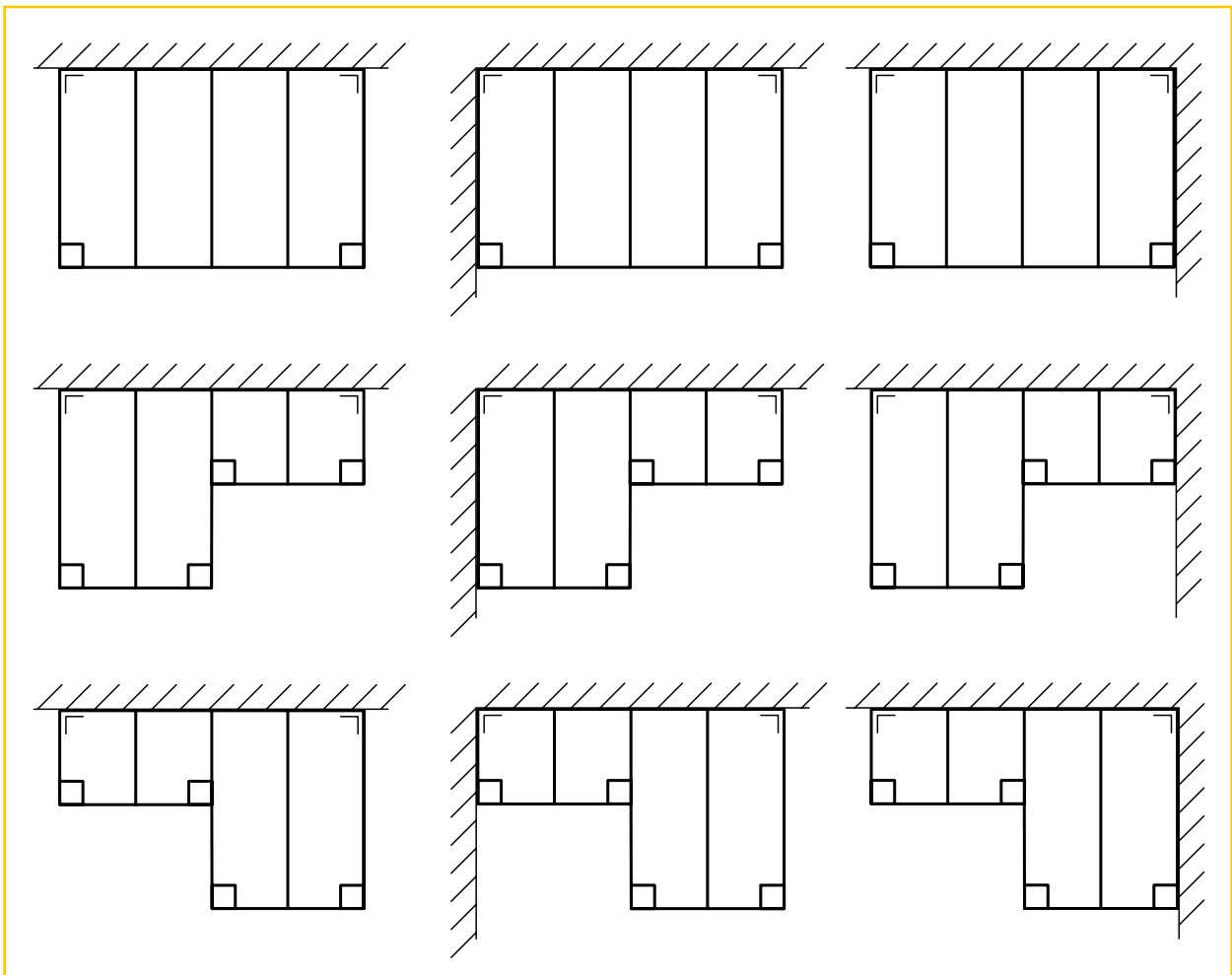

## Quick calculator Climalux without roof overhang

Info:

- Aluminium profile system with Classic gutter and aluminium push clips
- 2, 3 or 4 posts 110 x 141 x 2500mm are included in the price
- The roof pitch varies between 2° and 10° and starting from 5° with multi-walled sheets
- 2 standard RAL colours: white RAL 9010 & anthracite RAL 7016 ST – delivery time: max. 3 weeks.
- 8 “trend” RAL colours: cream white RAL 9001, black RAL 9005 ST, white aluminium RAL 9006 ST, grey aluminium RAL 9007 ST, RAL 9009 ST (DB703), RAL 9010 ST, purple red RAL 3004 ST & RAL 7039 ST – surcharge: € 200 net – delivery time: on request.
- Other RAL colours: see p. 8 & 9 (price on request) – delivery time: on request.
- Plastic sheets or glass not included in the price
- Maximum deflection of the profiles: 1/200
- Drainpipe and accessories included

Calculate the price as follows:

- Measure the roof’s width B (mm) and depth D (mm).
- Select the next size up in the table and read off the prices of the profiles.
- Multiply the sheet or glass area, indicated in the same box, by the price/m<sup>2</sup> of the sheet or the glass (not supplied by Skylux).

### For 16mm sheets without roof overhang

CLIMALUX CLASSIC prepared for 16mm thick and 980mm wide multi-walled sheets (650N/m <sup>2</sup> snow load & pitch 8°)								
Width 'B' (in mm) → ↓ Depth 'D' (in mm)	3000	4000	5000	6000	7000	8000	9000	10000
<b>2359 (2500mm incl. support)</b>	€ 2291	€ 2653	€ 3349	€ 3715	€ 4165	€ 4792	€ 5361	€ 6180
#m <sup>2</sup> sheets	7.4	9.8	12.3	14.7	17.2	19.6	22.1	24.5
<b>2859 (3000mm incl. support)</b>	€ 2455	€ 2858	€ 3593	€ 4000	€ 4489	€ 5156	€ 6259	€ 6624
#m <sup>2</sup> sheets	8.8	11.8	14.7	17.6	20.6	23.5	26.5	29.4
<b>3359 (3500mm incl. support)</b>	€ 2622	€ 3065	€ 3757	€ 4286	€ 4815	€ 5522	€ 6664	€ 6803
#m <sup>2</sup> sheets	10.3	13.7	17.2	20.6	24.0	27.4	30.9	34.3
<b>3859 (4000mm incl. support)</b>	€ 2809	€ 3538	€ 4023	€ 4592	€ 5162	€ 6400	€ 7090	€ 7269
#m <sup>2</sup> sheets	11.8	15.7	19.6	23.5	27.4	31.4	35.3	39.2
<b>4359 (4500mm incl. support)</b>	€ 3097	€ 3906	€ 4472	€ 5118	€ 5766	€ 7085	€ 7854	€ 8800
#m <sup>2</sup> sheets	13.2	17.6	22.1	26.5	30.9	35.3	39.7	44.1
<b>Supports</b>	2 supports			3 supports			4 supports	

Please note: these prices are indicative and not binding!

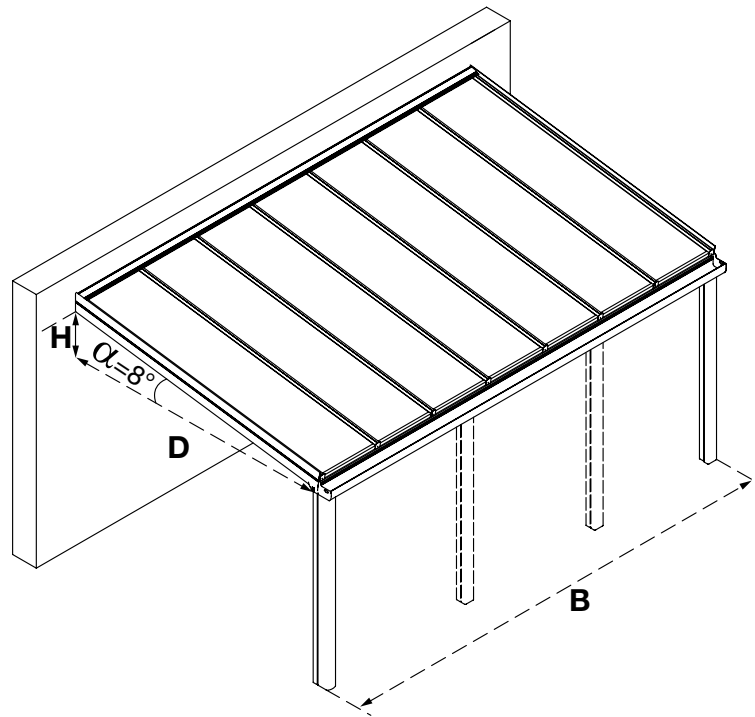

For glass without roof overhang

CLIMALUX CLASSIC prepared for 8mm LSG (850N/m <sup>2</sup> snow load & pitch 8°)								
Width 'B' (in mm) → ↓ Depth 'D' (in mm)	3000	4000	5000	6000	7000	8000	9000	10000
<b>2359 (2500mm incl. support)</b>	€ 2485	€ 3345	€ 3699	€ 4134	€ 4570	€ 5939	€ 6498	€ 6544
#m <sup>2</sup> glass panels	6.9	9.2	11.6	13.9	16.3	18.6	21.0	23.4
<b>2859 (3000mm incl. support)</b>	€ 2690	€ 3630	€ 4023	€ 4498	€ 4973	€ 6423	€ 6632	€ 7107
#m <sup>2</sup> glass panels	8.3	11.1	14.0	16.9	19.7	22.5	25.4	28.2
<b>3359 (3500mm incl. support)</b>	€ 2897	€ 3915	€ 4349	€ 4864	€ 5872	€ 6908	€ 7158	€ 7672
#m <sup>2</sup> glass panels	9.8	13.1	16.4	19.8	23.1	26.4	29.7	33.1
<b>3859 (4000mm incl. support)</b>	€ 3123	€ 4140	€ 4696	€ 5251	€ 6297	€ 7270	€ 7703	€ 8751
#m <sup>2</sup> glass panels	11.2	15.0	18.8	22.7	26.5	30.3	34.1	38.0
<b>Supports</b>	<b>2 supports</b>		<b>3 supports</b>			<b>4 supports</b>		
# of glass panels	4	6	7	8	9	11	12	13

Please note: these prices are indicative and not binding!

Roof systems with glass and sandwich panels are now also available with a slope of 2. Prices can be calculated on request with Climafast.

Optional					
	(mm)	3500	5000	6000	7000
Softline gutter attachment GLX		€ 265	€ 377	€ 451	€ 527
	(mm)	2500	3250	5000	6500
Surcharge/post for post 150 x 150mm		€ 210	€ 262		

## Quick calculator Climalux without roof overhang freestanding roof

A Climalux roof system can also be installed as a freestanding patio roof instead of against a wall. A freestanding patio roof does not need any supporting walls and can be placed anywhere in your garden. As with all Climalux systems, the detached version combines with plastic sheets (16 or 32mm) or glass. To guarantee the stability of a freestanding patio roof, the posts must be concreted into the ground according to our instructions.

### For 16mm sheets without roof overhang – freestanding

CLIMALUX CLASSIC FREESTANDING prepared for 16mm thick and 980mm wide multi-walled sheets (650N/m <sup>2</sup> snow load & 5° pitch)					
Width 'B' (in mm) → ↓ Depth 'D' (in mm)	3000	4000	5000	6000	7000
<b>2249 (2500mm support incl.)</b>	€ 4002	€ 4608	€ 5325	€ 5862	€ 6470
#m <sup>2</sup> sheets	6.9	9.4	11.8	13.7	16.2
<b>2749 (3000mm support incl.)</b>	€ 4262	€ 4908	€ 5665	€ 6241	€ 6890
#m <sup>2</sup> sheets	8.8	11.8	14.7	17.6	20.6
<b>3249 (3500mm support incl.)</b>	€ 4429	€ 5115	€ 5837	€ 6527	€ 7216
#m <sup>2</sup> sheets	10.3	13.7	17.2	20.6	24.0
<b>3749 (4000mm support incl.)</b>	€ 4815	€ 5541	€ 6303	€ 7033	€ 7762
#m <sup>2</sup> sheets	11.8	15.7	19.6	23.5	27.4
<b>4249 (4500mm support incl.)</b>	€ 5385	€ 6459	€ 7032	€ 7842	€ 9009
#m <sup>2</sup> sheets	13.2	17.6	22.1	26.5	30.9
<b>front posts VS back posts</b>	<b>2 &amp; 2 posts</b>		<b>3 &amp; 2 posts</b>		<b>3 &amp; 3 posts</b>

**Please note: these prices are indicative and not binding!**

The front posts below the gutter are 110 x 141mm. The back posts below the GDG are 110 x 110mm.

All posts must be concreted into the ground at least 40cm deep.

Surcharge for posts of 150 x 150mm (instead of 110 x 141mm): + € 244 gross per post.

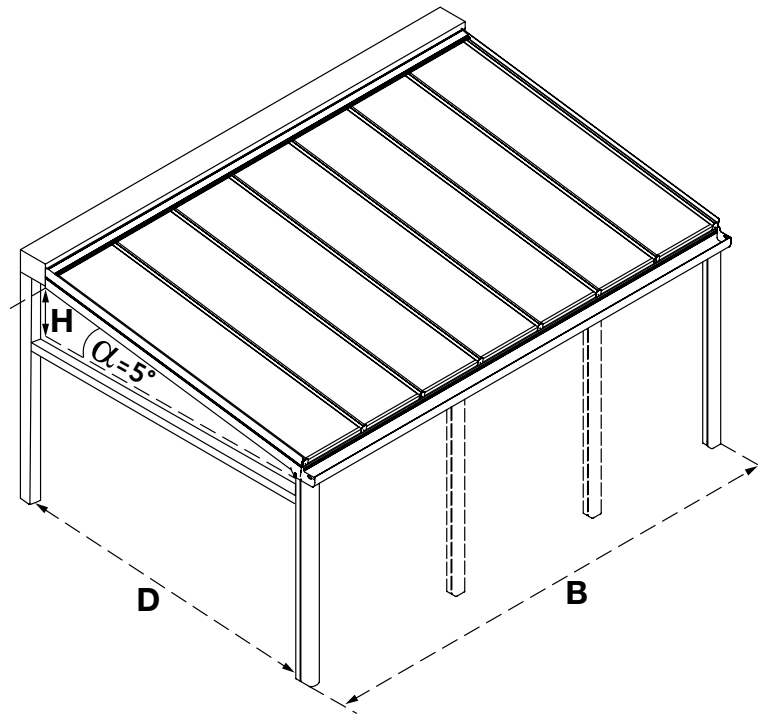

For glass without roof overhang – freestanding

CLIMALUX CLASSIC FREESTANDING prepared for 8mm LSG (850N/m <sup>2</sup> snow load & 5° pitch)					
Width 'B' (in mm) → ↓ Depth 'D' (in mm)	3000	4000	5000	6000	7000
<b>2249 (2500mm support incl.)</b>	€ 4197	€ 5052	€ 5683	€ 6280	€ 7114
#m <sup>2</sup> glass panels	6.5	8.7	10.7	13.1	15.0
<b>2749 (3000mm support incl.)</b>	€ 4497	€ 5700	€ 6102	€ 6739	€ 7614
#m <sup>2</sup> glass panels	7.9	10.6	13.3	16.0	18.7
<b>3249 (3500mm support incl.)</b>	€ 4703	€ 5986	€ 6427	€ 7105	€ 8020
#m <sup>2</sup> glass panels	9.3	12.5	15.7	18.9	22.1
<b>3749 (4000mm support incl.)</b>	€ 5129	€ 6492	€ 6973	€ 7927	€ 9181
#m <sup>2</sup> glass panels	10.8	14.4	18.1	21.8	25.5
<b>front posts VS back posts</b>	2/2 posts		3/2 posts	3/3 posts	
# of glass panels	4	6	7	8	9

Please note: these prices are indicative and not binding!

The front posts below the gutter are 110 x 141mm. The back posts below the GDx are 110 x 110mm.

All posts must be concreted into the ground at least 40cm deep.

Surcharge for posts of 150 x 150mm (instead of 110 x 141mm): + € 244 gross per post.

Roof systems with glass and sandwich panels are now also available with a slope of 2. Prices can be calculated on request with Climafast.

Optional					
	(mm)	3500	5000	6000	7000
Softline gutter attachment GLX		€ 265	€ 377	€ 451	€ 527

## Quick calculator Climalux standard roofs without roof overhang

**NEW**

The following standard sizes have already been prepacked and are available from stock within about a week after the order date.

Please note: these prices are indicative and not binding!

### Climalux standard roofs for sheets

CLIMALUX CLASSIC prepared for 16mm thick and 980mm wide multi-walled sheets* (650N/m <sup>2</sup> snow load & pitch 8°)				
Width 'B' (in mm) → ↓ Depth 'D' (in mm)	4000	5000	6000	7000
<b>2859 (3000mm incl. support)</b>	<b>€ 2864.23</b>	<b>€ 3525.85</b>	<b>€ 4028.64</b>	<b>€ 4521.93</b>
Items° RAL 7016 ST	41329	41331	41333	48287
Items° RAL 9010	41330	41332	41334	48288
<b>3359 (3500mm incl. support)</b>	<b>€ 3057.36</b>	<b>€ 3756.44</b>	<b>€ 4296.68</b>	<b>€ 4827.43</b>
Items° RAL 7016 ST	41335	41337	41339	48289
Items° RAL 9010	41336	41338	41340	48290
<b>3859 (4000mm incl. support)</b>	<b>€ 3250.50</b>	<b>€ 3987.03</b>	<b>€ 4564.73</b>	<b>€ 5132.93</b>
Items° RAL 7016 ST	41341	41343	41345	48291
Items° RAL 9010	41342	41344	41346	48292
<b>Supports (included)</b>	<b>2 supports</b>	<b>3 supports</b>		

\* plastic sheets are not included in the price

### Climalux standard sets

Description	Length (in mm)	Items° (RAL 7016 ST)	Items° (RAL 9010)	Price/box
<b>Rafter set (2 rafters/box)</b>	3000	36664	36660	<b>€ 628.72</b>
<b>Rafter set (3 rafters/box)</b>	3000	36665	36661	<b>€ 943.08</b>
<b>Rafter set (2 rafters/box)</b>	3500	36666	36662	<b>€ 703.63</b>
<b>Rafter set (3 rafters/box)</b>	3500	36667	36663	<b>€ 1055.45</b>
<b>Rafter set (2 rafters/box)</b>	4000	40983	40984	<b>€ 778.54</b>
<b>Rafter set (3 rafters/box)</b>	4000	40985	40986	<b>€ 1167.81</b>
<b>Side rafter set</b>	3000	36658	36656	<b>€ 612.22</b>
<b>(2 side rafters/box)</b>	3500	36659	36657	<b>€ 692.99</b>
	4000	40980	40981	<b>€ 773.76</b>
<b>Wall connection and gutter set</b>	4000	36653	36650	<b>€ 901.15</b>
	5000	36654	36651	<b>€ 1078.59</b>
	6000	36655	36652	<b>€ 1254.08</b>
	7000	48277	48276	<b>€ 1420.07</b>
<b>Support set (1 support/box)</b>	2500	36670	36668	<b>€ 156.88</b>
<b>Support set (2 supports/box)</b>	2500	36671	36669	<b>€ 313.76</b>
<b>Support set (1 support/box)</b>	3250	48437	48435	<b>€ 198.39</b>
<b>Support set (2 supports/box)</b>	3250	48438	48436	<b>€ 396.77</b>
<b>Sheets accessories set</b>	4000	48279	48280	<b>€ 94.02</b>
	5000	48281	48282	<b>€ 106.96</b>
	6000	48283	48284	<b>€ 119.90</b>
	7000	48285	48286	<b>€ 132.84</b>

For example: a standard Climalux roof 4000 x 2859 in RAL7016 structure (item 41329) consists of: 1x item 36665, 1x 36658, 1x item 36653, 1x item 36671 & 1x item 48279

Optional Climalux lighting

ATTENTION! If glass is used, we also recommend ordering the optional L432 profile as glass cover on the gutter + silicone glue.



### Set contents

Rafter set	rafter DX aluminium clips CL16 spacer AX rubber pieces tampers
Side rafter set	rafter DX side clips CLLX spacer AX rubber pieces tampers
Wall connection and gutter set	wall connection section MX classic gutter profile GX wall rubber drainpipe screws and nail anchors drain support and bends gutter and wall fittings touch up paint pen
Support set	support post PX (110 x 141 x 2500/3250mm) U-top/bottom
Accessories set	tapes BB16 and BT16 silicone aluminium sealing profile U16

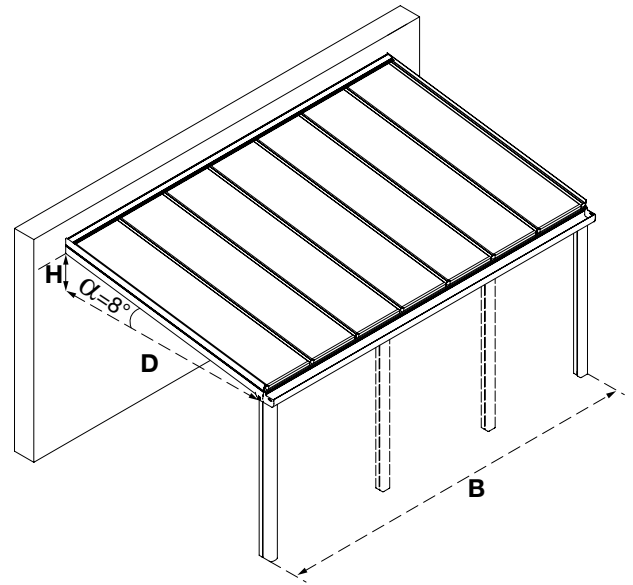

INFO:

- \* Max. deflection of the profiles: 1/200
- \* Delivery time: approx. 1 week

### Assembly data (only for standard roofs)

↓ Depth (D) (in mm)	Width (B) (in mm) →	4000	5000	6000	7000
<b>2859</b>	Δ H	400	400	400	400
<b>(3000mm incl. support)</b>	Sheet length	2919	2919	2919	2919
	Sheet width	2 x 980 + 2 x 946	3 x 980 + 2 x 945	4 x 980 + 2 x 944	5 x 980 + 2 x 943
	AX profile	4 x 942 + 4 x 908	6 x 942 + 4 x 907	8 x 942 + 4 x 906	10 x 942 + 4 x 905
<b>3359</b>	Δ H	470	470	470	470
<b>(3500mm incl. support)</b>	Sheet length	3424	3424	3424	3424
	Sheet width	2 x 980 + 2 x 946	3 x 980 + 2 x 945	4 x 980 + 2 x 944	5 x 980 + 2 x 943
	AX profile	4 x 942 + 4 x 908	6 x 942 + 4 x 907	8 x 942 + 4 x 906	10 x 942 + 4 x 905
<b>3859</b>	Δ H	540	540	540	540
<b>(4000mm incl. support)</b>	Sheet length	3929	3929	3929	3929
	Sheet width	2 x 980 + 2 x 946	3 x 980 + 2 x 945	4 x 980 + 2 x 944	5 x 980 + 2 x 943
	AX profile	4 x 942 + 4 x 908	6 x 942 + 4 x 907	8 x 942 + 4 x 906	10 x 942 + 4 x 905

## Quick calculator Climalux with roof overhang

Info:

- Aluminium profile system with Classic gutter and aluminium push clips
- 2, 3 of 4 posts 110 x 110 x 2500mm are included in the price
- 2 standard RAL colours: white RAL 9010 & anthracite RAL 7016 ST. Delivery time max. 3 weeks
- 8 “trend” RAL colours: cream white RAL 9001, black RAL 9005 ST, white aluminium RAL 9006 ST, grey aluminium RAL 9007 ST, RAL 9009 ST (DB703), RAL 9010 ST, purple red RAL 3004 ST & RAL 7039 ST. Surcharge: € 200 net – delivery time: on request
- Other RAL colours: see p. 8 & 9 (price on request) – delivery time: on request
- Plastic sheets or glass not included in the price
- Maximum deflection of the profiles: 1/200
- Drainpipe and accessories included
- A roof overhang of max. 550mm is possible

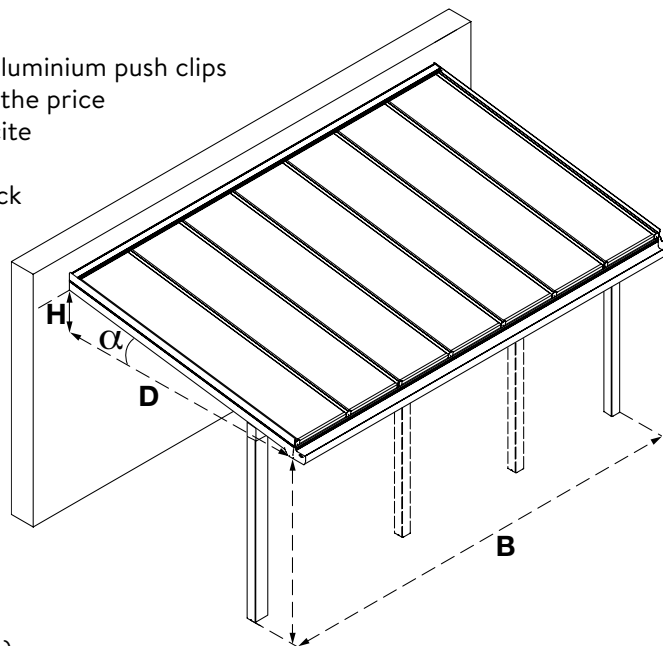

Calculate the price as follows:

- Measure the roof’s width B (mm) and depth D (mm).
- Select the next size up in the table and read off the prices of the profiles.
- Multiply the sheet or glass area, indicated in the same box, by the price/m<sup>2</sup> of the sheet or the glass (not supplied by Skylux).

## For 16mm sheets with roof overhang

CLIMALUX CLASSIC prepared for 16mm thick and 980mm wide multi-walled sheets (650N/m <sup>2</sup> snow load & pitch 8°)								
Width 'B' (in mm) → ↓ Depth 'D' (in mm)	3000	4000	5000	6000	7000	8000	9000	10000
<b>2359 (d'=1699mm)</b>	€ 3220	€ 3845	€ 4314	€ 4945	€ 5575	€ 6929	€ 7397	€ 7867
#m <sup>2</sup> sheets	7.4	9.8	12.3	14.7	17.2	19.6	22.1	24.5
<b>2859 (d'=2199mm)</b>	€ 3386	€ 4050	€ 4559	€ 5229	€ 5900	€ 7293	€ 7801	€ 8310
#m <sup>2</sup> sheets	8.8	11.8	14.7	17.6	20.6	23.5	26.5	29.4
<b>3359 (d'=2699mm)</b>	€ 3551	€ 4256	€ 4805	€ 5515	€ 6226	€ 7658	€ 8207	€ 8756
#m <sup>2</sup> sheets	10.3	13.7	17.2	20.6	24.0	27.4	30.9	34.3
<b>3859 (d'=3199mm)</b>	€ 3738	€ 4483	€ 5072	€ 5822	€ 6572	€ 8044	€ 8633	€ 9222
#m <sup>2</sup> sheets	11.8	15.7	19.6	23.5	27.4	31.4	35.3	39.2
<b>4359 (d'=3699mm)</b>	€ 4026	€ 4851	€ 5519	€ 6348	€ 7383	€ 8729	€ 9397	€ 10066
#m <sup>2</sup> sheets	13.2	17.6	22.1	26.5	30.9	35.3	39.7	44.1
<b>4800 (d'=4140mm)</b>	€ 4026	€ 4851	€ 5519	€ 6348	€ 7383	€ 8729	€ 9397	€ 10066
#m <sup>2</sup> sheets	14.7	19.6	24.5	29.4	34.3	39.2	44.1	49.0
<b>Supports (included)</b>	<b>2 supports</b>				<b>3 supports</b>			

GDX cross-beam included in the price.

**Please note: these prices are indicative and not binding!**

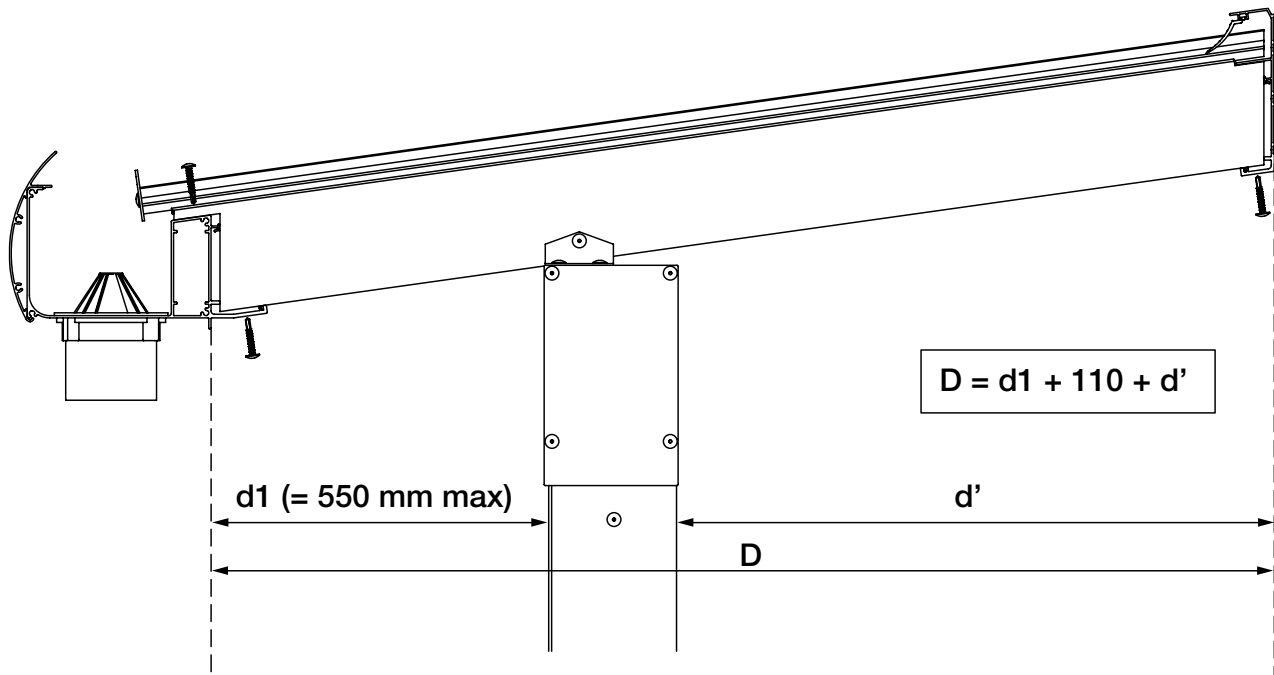

For glass with roof overhang

CLIMALUX CLASSIC prepared for 8mm LSG (850N/m <sup>2</sup> snow load & pitch 8°)								
Width 'B' (in mm) → ↓ Depth 'D' (in mm)	3000	4000	5000	6000	7000	8000	9000	10000
<b>2359 (d' = 1699mm)</b>	€ 3436	€ 4333	€ 4790	€ 5406	€ 6228	€ 7647	€ 8105	€ 8561
#m <sup>2</sup> glass panels	6.9	9.2	11.6	13.9	16.3	18.6	20.9	23.3
<b>2859 (d' = 2199mm)</b>	€ 3641	€ 4617	€ 5114	€ 5770	€ 6633	€ 8131	€ 8628	€ 9125
#m <sup>2</sup> glass panels	8.3	11.1	14.0	16.8	19.7	22.5	25.3	28.2
<b>3359 (d' = 2699mm)</b>	€ 3848	€ 4903	€ 5440	€ 6137	€ 7038	€ 8616	€ 9153	€ 9689
#m <sup>2</sup> glass panels	9.8	13.0	16.4	19.8	23.1	26.4	29.7	33.1
<b>3859 (d' = 3199mm)</b>	€ 4074	€ 5210	€ 5787	€ 6729	€ 7465	€ 9124	€ 9699	€ 10274
#m <sup>2</sup> glass panels	11.2	15.0	18.8	22.7	26.5	30.3	34.1	37.9
<b>4359 (d' = 3699mm)</b>	€ 4442	€ 5734	€ 6391	€ 7414	€ 8229	€ 10045	€ 10702	€ 11358
#m <sup>2</sup> glass panels	12.6	16.9	21.2	25.6	29.9	34.2	38.5	42.8
<b>Supports (included)</b>	2 supports			3 supports				
# of glass panels	4	6	7	8	9	11	12	13

GDX cross-beam included in the price.

Please note: these prices are indicative and not binding!

Roof systems with glass and sandwich panels are now also available with a slope of 2. Prices can be calculated on request with Climafast.

Optional					
	(mm)	3500	5000	6000	7000
Softline gutter attachment GLX		€ 265	€ 377	€ 451	€ 527

## SELF-SUPPORTING NON-THERMAL PROFILE SYSTEM (cold roof)

### CLIMALUX HORIZON

- Sleek and contemporary design
- A wide view at an affordable price
- Span length of up to 6 metres depending on the snow load, depth and chosen glazing
- No visible screws and bolts on the outside

Climalux Horizon is made to fit and easy to install. The profile system is self-supporting thanks to the integration of the GXLX gutter. Span lengths up to 6 metres are possible, depending on the snow load, depth and glazing.

Example: the span length measures 5 metres for a glass roof of 4 metres deep with a snow load of 850N/m<sup>2</sup>. The patio roof can be even wider if you choose a smaller depth or plastic sheets.

The roof slope varies between 2° and 10° and starting from 5° with multi-walled sheets and is fitted for single glazing (8 or 10mm) or 16 or 32mm plastic sheets. Combining the Climalux Horizon with a roof overhang or Climacrown is not possible.

Having no intermediate posts, the budget-friendly Climalux Horizon offers you a great and undisturbed garden view. Additionally, the profile system itself has a sleek and contemporary design (no visible screws or bolts on the outside, modern looking gutter and post, fitted sealing plates, etc.).

- 2 standard RAL colours: white RAL 9010 & anthracite grey RAL 7016 ST. Delivery time: max. 3 weeks.
- 8 “trend” RAL colours: cream white RAL 9001, black RAL 9005 ST, white aluminium RAL 9006 ST, grey aluminium RAL 9007 ST, RAL 9009 ST, RAL 9010 ST, purple red RAL 3004 ST & RAL 7039 ST.  
Fixed surcharge: € 200 net. Delivery time: on request.
- Other RAL colours: see p. 8 & 9 (price on request). Delivery time: on request.



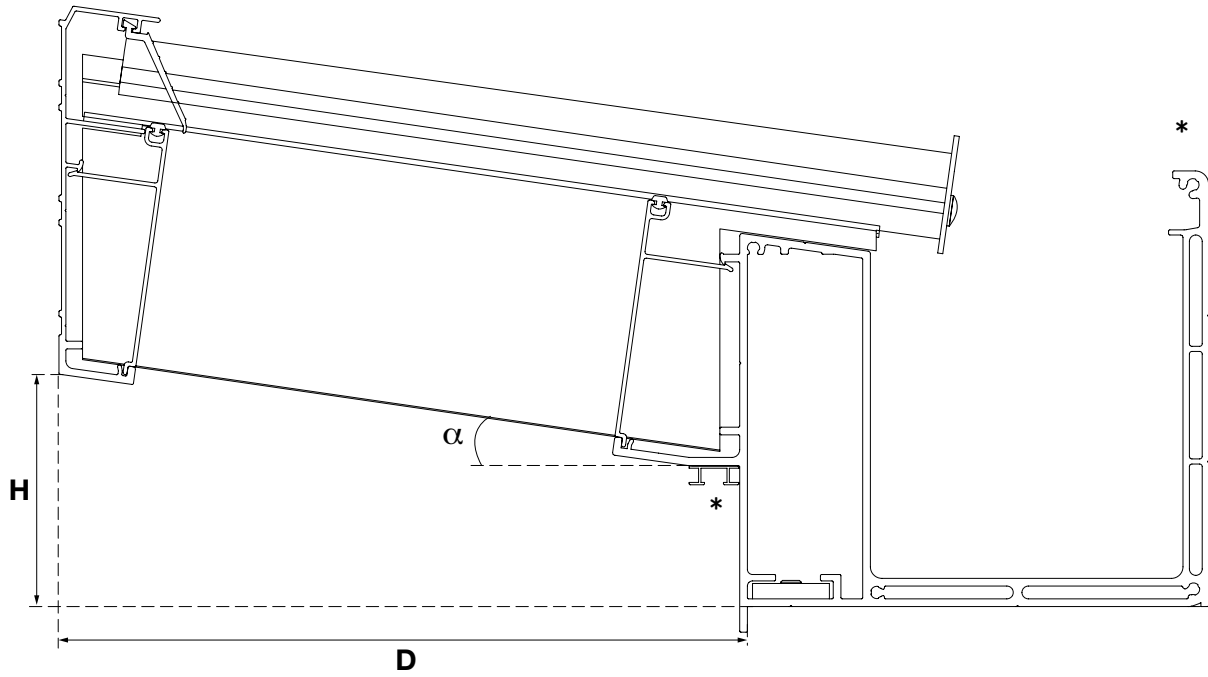

\* LED Stripes as an option

### Options

- Width B:  $\infty$
- Depth D: max. 5.5m
- The roof pitch  $\alpha$  varies between 2° and 10° and starting from 5° with multi-walled sheets

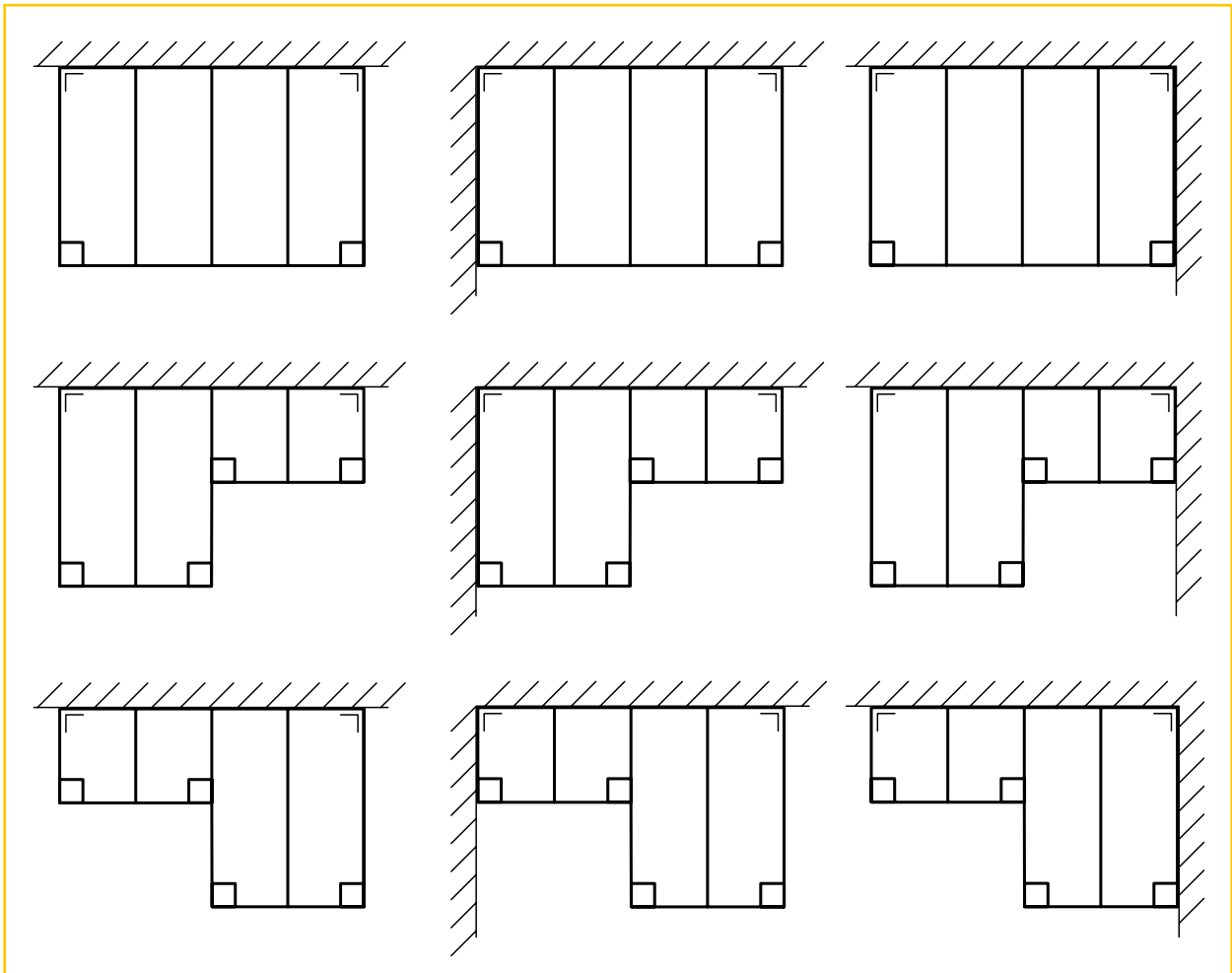

## Quick calculator Climalux Horizon

Info:

- Aluminium profile system with XL gutter and aluminium clips
- 2 or 3 posts are included in the price
- Two-piece posts 150 x 177 x 2500mm, drainpipe and accessories are included
- 2 standard RAL colours: white RAL 9010 & anthracite RAL 7016 ST – delivery time: max. 3 weeks.
- 8 “trend” RAL colours: cream white RAL 9001, black RAL 9005 ST, white aluminium RAL 9006 ST, grey aluminium RAL 9007 ST, RAL 9009 ST (DB703), RAL 9010 ST, purple red RAL 3004 ST & RAL 7039 ST – surcharge: € 200 net – delivery time: on request.
- Other RAL colours: see p. 8 & 9 (price on request) – delivery time: on request.
- Plastic sheets or glass not included in the price
- Maximum deflection of the profiles: 1/200

Calculate the price as follows:

- Measure the roof’s width B (mm) and depth D (mm).
- Select the next size up in the table and read off the prices of the profiles.
- Multiply the sheet or glass area, indicated in the same box, by the price/m<sup>2</sup> of the sheet or the glass (not supplied by Skylux).

### For 16mm plastic sheets

CLIMALUX HORIZON prepared for 16mm thick and 980mm wide multi-walled sheets (650N/m <sup>2</sup> snow load & pitch 8°)								
Width 'B' (in mm) → ↓ Depth 'D' (in mm)	3000	4000	5000	6000	7000	8000	9000	10000
<b>2323 (2500mm incl. support)</b>	€ 3240	€ 3543	€ 3869	€ 4375	€ 4881	€ 6338	€ 6664	€ 6990
#m <sup>2</sup> sheets	7.4	9.8	12.3	14.7	17.2	19.6	22.1	24.5
<b>2823 (3000mm incl. support)</b>	€ 3406	€ 3748	€ 4114	€ 4660	€ 5206	€ 6702	€ 7069	€ 7434
#m <sup>2</sup> sheets	8.8	11.8	14.7	17.6	20.6	23.5	26.5	29.4
<b>3323 (3500mm incl. support)</b>	€ 3573	€ 3955	€ 4361	€ 4946	€ 5934	€ 7067	€ 7474	€ 7880
#m <sup>2</sup> sheets	10.3	13.7	17.2	20.6	24.0	27.4	30.9	34.3
<b>3823 (4000mm incl. support)</b>	€ 3738	€ 4160	€ 4605	€ 5230	€ 6259	€ 7433	€ 7877	€ 8323
#m <sup>2</sup> sheets	11.8	15.7	19.6	23.5	27.4	31.4	35.3	39.2
<b>4323 (4500mm incl. support)</b>	€ 4069	€ 4571	€ 5109	€ 5801	€ 6910	€ 8162	€ 8687	€ 9213
#m <sup>2</sup> sheets	13.2	17.6	22.1	26.5	30.9	35.3	39.7	44.1
<b>Supports (included)</b>	<b>2 supports</b>				<b>3 supports</b>			

Please note: these prices are indicative and not binding!

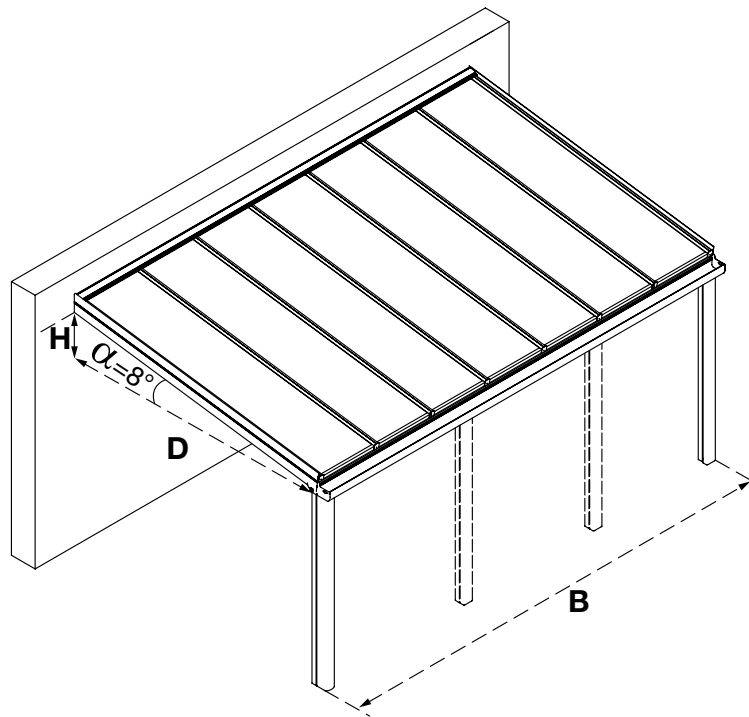

For glass

CLIMALUX HORIZON prepared for 8mm LSG (850N/m <sup>2</sup> snow load & pitch 8°)								
Width 'B' (in mm) → ↓ Depth 'D' (in mm)	3000	4000	5000	6000	7000	8000	9000	10000
<b>2323 (2500mm incl. support)</b>	€ 3436	€ 3986	€ 4301	€ 4794	€ 5690	€ 6994	€ 7308	€ 7621
#m <sup>2</sup> glass panels	6.9	9.2	11.6	13.9	16.3	18.6	21.0	23.4
<b>2823 (3000mm incl. support)</b>	€ 3641	€ 4272	€ 4626	€ 5158	€ 6093	€ 7477	€ 7831	€ 8184
#m <sup>2</sup> glass panels	8.3	11.1	14.0	16.9	19.7	22.5	25.4	28.2
<b>3323 (3500mm incl. support)</b>	€ 3848	€ 4558	€ 4951	€ 5927	€ 6500	€ 7962	€ 8356	€ 8749
#m <sup>2</sup> glass panels	9.8	13.1	16.4	19.8	23.1	26.4	29.7	33.1
<b>3823 (4000mm incl. support)</b>	€ 4053	€ 4842	€ 5276	€ 6291	€ 6903	€ 8446	€ 8880	€ 9312
#m <sup>2</sup> glass panels	11.2	15.0	18.8	22.7	26.5	30.3	34.1	38.0
<b>Supports (included)</b>	<b>2 supports</b>				<b>3 supports</b>			
# of glass panels	4	6	7	8	9	11	12	13

Please note: these prices are indicative and not binding!

Roof systems with glass are now also available with a slope of 2°. Prices can be calculated on request with Climafast.

## Quick calculator Climalux Horizon freestanding roof

A Climalux Horizon roof system can also be installed as a freestanding patio roof instead of against a wall. A freestanding patio roof does not need any supporting walls and can be placed anywhere in your garden. As with all Climalux systems, the detached version combines with plastic sheets (16 or 32mm) or glass. To guarantee the stability of a freestanding patio roof, the posts must be concreted into the ground according to our instructions.

### For 16mm plastic sheets – freestanding

CLIMALUX HORIZON FREESTANDING prepared for 16mm thick and 980mm wide multi-walled sheets (650N/m <sup>2</sup> snow load & 5° pitch)					
Width 'B' (in mm) → ↓ Depth 'D' (in mm)	3000	4000	5000	6000	7000
<b>2213 (2500mm support incl.)</b>	<b>€ 5008</b>	<b>€ 5549</b>	<b>€ 5874</b>	<b>€ 6541</b>	<b>€ 7202</b>
#m <sup>2</sup> sheets	6.9	9.4	11.8	13.7	16.2
<b>2713 (3000mm support incl.)</b>	<b>€ 5268</b>	<b>€ 5857</b>	<b>€ 6222</b>	<b>€ 6928</b>	<b>€ 7637</b>
#m <sup>2</sup> sheets	8.8	11.8	14.7	17.6	20.6
<b>3213 (3500mm support incl.)</b>	<b>€ 5434</b>	<b>€ 6063</b>	<b>€ 6468</b>	<b>€ 7214</b>	<b>€ 7963</b>
#m <sup>2</sup> sheets	10.3	13.7	17.2	20.6	24.0
<b>3713 (4000mm support incl.)</b>	<b>€ 6059</b>	<b>€ 6727</b>	<b>€ 7173</b>	<b>€ 7958</b>	<b>€ 9176</b>
#m <sup>2</sup> sheets	11.8	15.7	19.6	23.5	27.4
<b>4213 (4500mm support incl.)</b>	<b>€ 6391</b>	<b>€ 7139</b>	<b>€ 7664</b>	<b>€ 8529</b>	<b>€ 10185</b>
#m <sup>2</sup> sheets	13.2	17.6	22.1	26.5	30.9
<b>front posts VS back posts</b>	<b>2 &amp; 2 posts</b>				<b>3 &amp; 2 posts</b>

**Please note: these prices are indicative and not binding!**

The front posts below the gutter are 150 x 177mm. The back posts below the GDV are 110 x 110mm. All posts must be concreted into the ground at least 40cm deep.



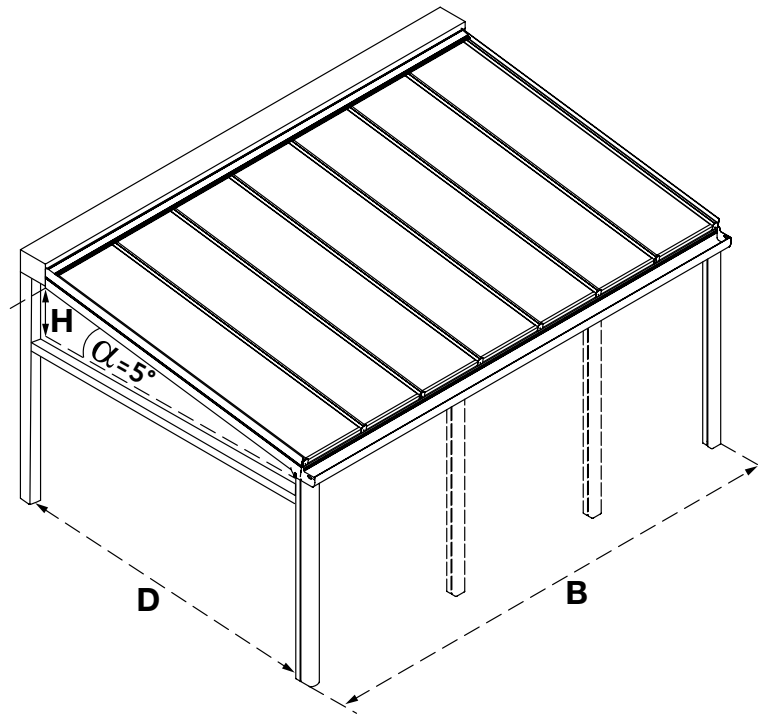

For glass – freestanding

CLIMALUX HORIZON FREESTANDING prepared for 8mm LSG (850N/m <sup>2</sup> snow load & pitch 8°)					
Width 'B' (in mm) → ↓ Depth 'D' (in mm)	3000	4000	5000	6000	7000
<b>2213 (2500mm support incl.)</b>	€ 5195	€ 5992	€ 6297	€ 6950	€ 8035
#m <sup>2</sup> glass panels	6.5	8.6	10.8	13.1	15.3
<b>front posts VS back posts</b>	2 & 2 posts				3 & 2 posts
<b>2713 (3000mm support incl.)</b>	€ 5503	€ 6379	€ 6733	€ 7426	€ 8790
#m <sup>2</sup> glass panels	7.9	10.5	13.2	15.9	18.6
<b>3213 (3500mm support incl.)</b>	€ 5709	€ 6665	€ 7059	€ 8112	€ 9195
#m <sup>2</sup> glass panels	9.3	12.4	15.6	18.8	22.0
<b>3713 (4000mm support incl.)</b>	€ 6375	€ 7410	€ 7843	€ 8936	€ 10178
#m <sup>2</sup> glass panels	10.8	14.4	18.0	21.7	25.4
<b>front posts VS back posts</b>	2 & 2 posts				3 & 3 posts
# of glass panels	4	6	7	8	9

Please note: these prices are indicative and not binding!

The front posts below the gutter are 150 x 177mm. The back posts below the GDV are 110 x 110mm. All posts must be concreted into the ground at least 40cm deep.

Roof systems with glass and sandwich panels are now also available with a slope of 2°. Prices can be calculated on request with Climafast.

## SELF-SUPPORTING NON-THERMAL PROFILE SYSTEM (cold roof)

### CLIMACROWN ROOF (cold roof)

If you are drawn to the modern flat roof with the advantage of a sloping roof for water drainage, the Climacrown won't disappoint.

The Climacrown is based on the Climalux profiles, with a modular crown profile as an extra feature. The crown profile can be provided with LED lighting (optional).

This self-supporting profile system is completely made to size and is easily installed. The Climacrown roof can be provided with 16 or 32mm plastic sheets or glass of 8 or 10mm (not supplied by Skylux). Climacrown is preferably used with a pitch of 2° and starting from 5° with multi-walled sheets.

- 2 standard RAL colours: white RAL 9010 (code RWB964) and anthracite RAL 7016 ST (code 029/71334). Delivery time: max. 3 weeks.
- 8 "trend" RAL colours: cream white RAL 9001 (code AE70019220225), black RAL 9005 ST (code AE03054900520), white aluminium RAL 9006 ST (code 029/90146), grey aluminium RAL 9007 ST (code 029/90147), RAL 9009 ST (DB703) (code 029/80077), RAL 9010 ST (code AE03059901020), purple red RAL 3004 ST (code AE03053300420) & RAL 7039 ST (code AE03057703920). Surcharge: € 200 net. Delivery time: on request.
- Other RAL colours: see p. 8 & 9 (price on request). Delivery time: on request.



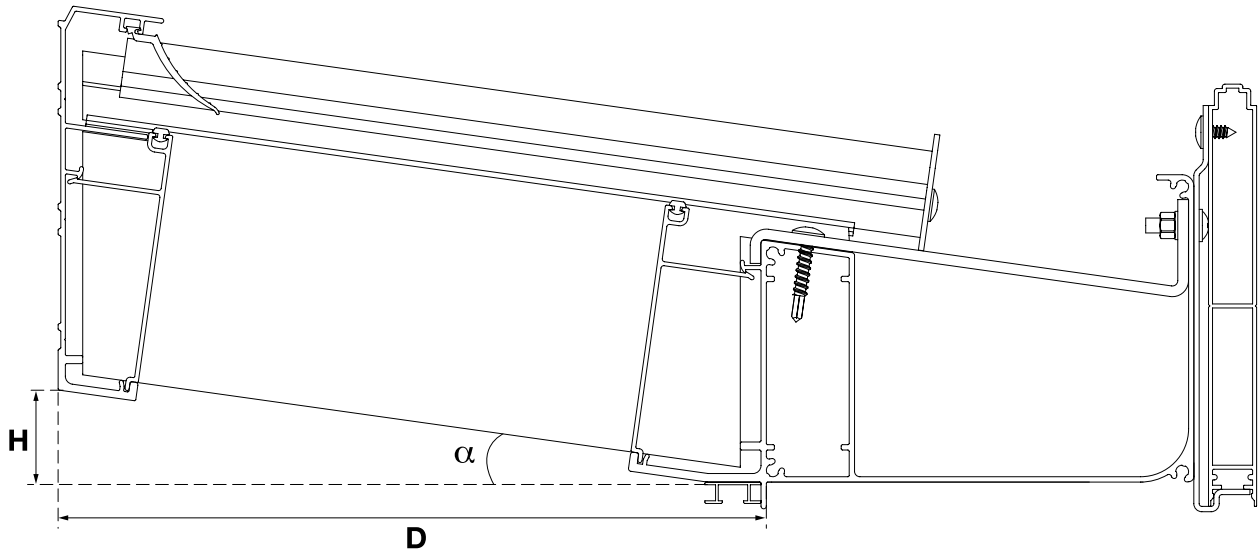

### Options

- Width B: max. 7m
- Depth D: max. 4m
- Roof pitch  $\alpha$  2° and starting from 5° with multi-walled sheets

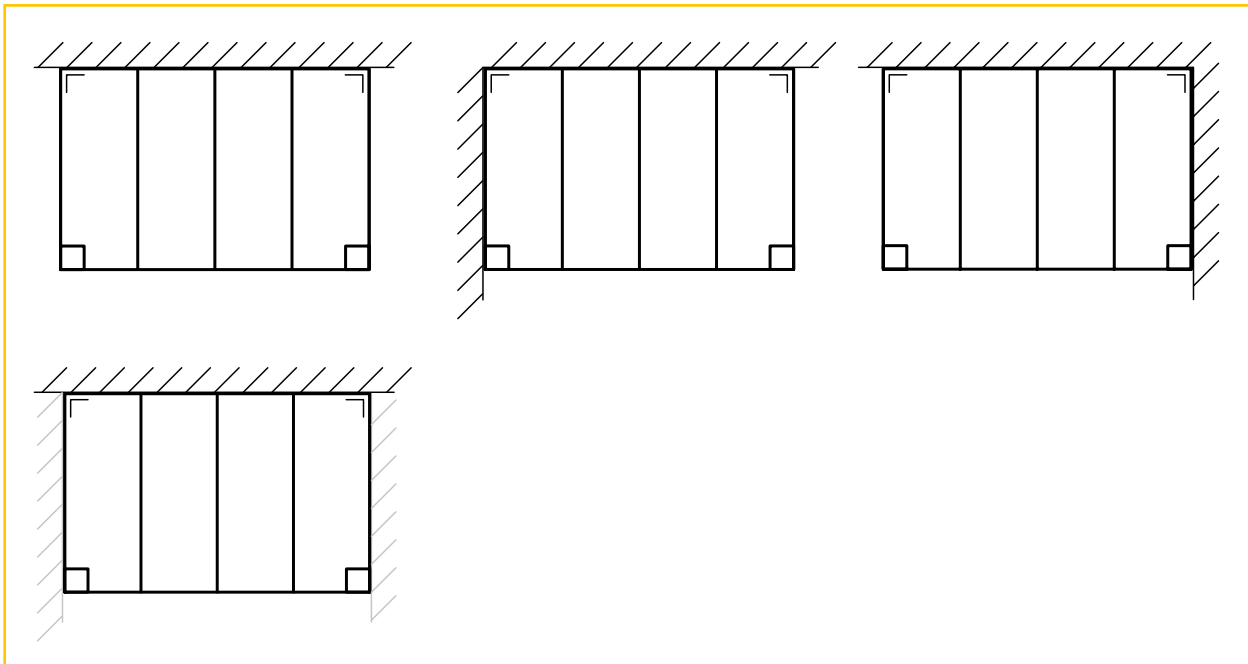

## Quick calculator Climacrown

Info:

- Aluminium profile system with Classic gutter and aluminium push clips
- 2 or 3 posts 150 x 150 x 2500mm are included in the price
- Roof pitch 2° and starting from 5° with multi-walled sheets
- 2 standard RAL colours: white RAL 9010 (code RWB964) and anthracite grey RAL 7016 ST (code 029/71334) – delivery time: max. 3 weeks
- 8 “trend” RAL colours: cream white RAL 9001, black RAL 9005 ST, white aluminium RAL 9006 ST, grey aluminium RAL 9007 ST, RAL 9009 ST (DB703), RAL 9010 ST, purple red RAL 3004 ST & RAL 7039 ST – surcharge: € 200 net – delivery time: on request
- Other RAL colours: see p. 8 & 9 (price on request) – delivery time: on request
- Plastic sheets or glass not included in the price
- Maximum deflection of the profiles: 1/200
- Drainpipe and accessories included
- The crown profile is modular and the profiles are max. 7 meters long
- Height of the crown profile depends on the roof’s depth and is built in stages of 75mm
- We also deliver all profiles and assembly accessories
- There are no visible screws on the outside of the crown profile
- LED lighting can be provided in the Climacrown

Calculate the price as follows:

- Measure the roof’s width B (mm) and depth D (mm).
- Select the next size up in the table and read off the prices of the profiles.
- Multiply the sheet or glass area, indicated in the same box, by the price/m<sup>2</sup> of the sheet or the glass (not supplied by Skylux).

### For 16mm sheets

CLIMALUX with CLIMACROWN prepared for 16mm thick and 980mm wide multi-walled sheets (650N/m <sup>2</sup> snow load & pitch 5°)						
Width ‘B’ (in mm) → ↓ Depth ‘D’ (in mm)	3000	4000	5000	6000	7000	Climacrown height
<b>2350 (2500mm incl. support)</b> #m <sup>2</sup> sheets	€ 3957 7.4	€ 4347 9.8	€ 5109 12.3	€ 5882 14.7	€ 6398 17.2	385mm
<b>2850 (3000mm incl. support)</b> #m <sup>2</sup> sheets	€ 4454 8.8	€ 4918 11.8	€ 5678 14.7	€ 6554 17.6	€ 7067 20.6	460mm
<b>3350 (3500mm incl. support)</b> #m <sup>2</sup> sheets	€ 4620 10.3	€ 5126 13.7	€ 6053 17.2	€ 6840 20.6	€ 7393 24.0	460mm
<b>3850 (4000mm incl. support)</b> #m <sup>2</sup> sheets	€ 5426 11.8	€ 6290 15.7	€ 7010 19.6	€ 7889 23.5	€ 8484 27.4	535mm
<b>4350 (4500mm incl. support)</b> #m <sup>2</sup> sheets	€ 5808 13.2	€ 6902 17.6	€ 7704 22.1	€ 8683 26.5	€ 9357 30.9	610mm
<b>Supports (included)</b>	<b>2 supports</b>		<b>3 supports</b>			

**Please note: these prices are indicative and not binding!**

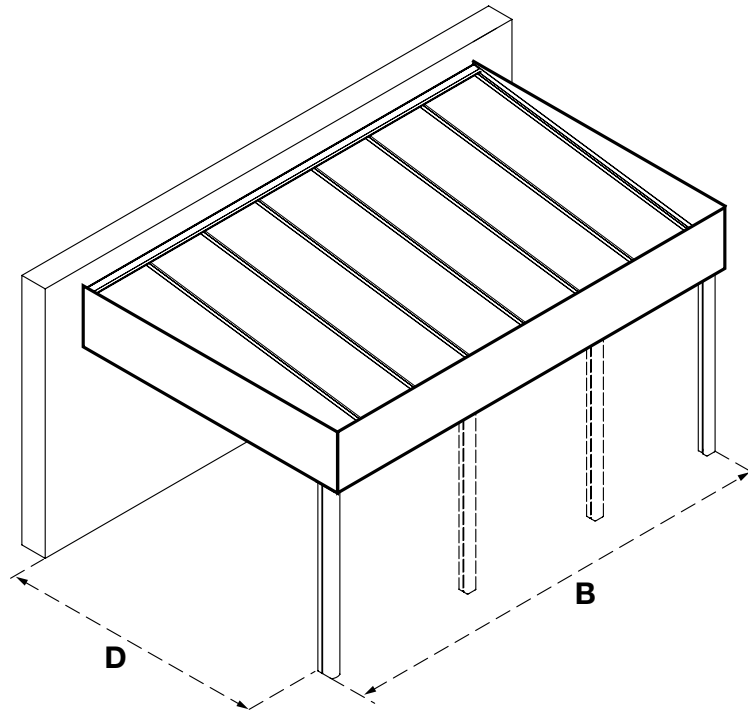

For glass

CLIMALUX with CLIMACROWN prepared for 8mm LSG (850N/m <sup>2</sup> snow load & pitch 5°)						
Width 'B' (in mm) → ↓ Depth 'D' (in mm)	3000	4000	5000	6000	7000	Climacrown height
2350 (2500mm incl. support) #m <sup>2</sup> glass panels	€ 4179 6.9	€ 5216 9.2	€ 5720 11.6	€ 6352 13.9	€ 6854 16.3	385mm
2850 (3000mm incl. support) #m <sup>2</sup> glass panels	€ 4715 8.3	€ 5740 11.1	€ 6368 14.0	€ 7103 16.8	€ 7605 19.7	460mm
3350 (3500mm incl. support) #m <sup>2</sup> glass panels	€ 4921 9.8	€ 6025 13.0	€ 6694 16.4	€ 7468 19.8	€ 8502 23.1	460mm
3850 (4000mm incl. support) #m <sup>2</sup> glass panels	€ 5766 11.2	€ 7151 15.0	€ 7732 18.8	€ 8599 22.7	€ 9671 26.5	535mm
Supports (included)	2 supports		3 supports			
# of glass panels	4	6	7	8	9	

Please note: these prices are indicative and not binding!

Roof systems with glass and sandwich panels are now also available with a slope of 2°. Prices can be calculated on request with Climafast.

Option: surcharge for version with LED lighting						
Width 'B' (in mm) → ↓ Depth 'D' (in mm)	3000	4000	5000	6000	7000	Climacrown height
2350 (2500mm incl. support)	€ 670	€ 670	€ 758	€ 789	€ 834	385mm
2850 (3000mm incl. support)	€ 670	€ 682	€ 758	€ 802	€ 834	460mm
3350 (3500mm incl. support)	€ 682	€ 682	€ 769	€ 802	€ 847	460mm
3850 (4000mm incl. support)	€ 682	€ 694	€ 769	€ 814	€ 847	535mm
4350 (4500mm incl. support)	€ 844	€ 844	€ 931	€ 964	€ 1008	610mm

## Quick calculator Climacrown freestanding roof

A Climacrown roof system can also be installed as a freestanding patio roof instead of against a wall. A freestanding patio roof does not need any supporting walls and can be placed anywhere in your garden. As with all Climalux systems, the detached version combines with plastic sheets (16 or 32mm) or glass. To guarantee the stability of a freestanding patio roof, the posts must be concreted into the ground according to our instructions.

### For 16mm sheets – freestanding

CLIMALUX WITH CLIMACROWN FREESTANDING prepared for 16mm thick and 980mm wide multi-walled sheets (650N/m <sup>2</sup> snow load & 5° pitch)						
Width 'B' (in mm) → ↓ Depth 'D' (in mm)	3000	4000	5000	6000	7000	Climacrown height
<b>2240 (2500mm support incl.)</b>	<b>€ 6242</b>	<b>€ 7163</b>	<b>€ 7906</b>	<b>€ 9106</b>	<b>€ 9736</b>	385mm
#m <sup>2</sup> sheets	6.9	9.4	11.8	13.7	16.2	
<b>2740 (3000mm support incl.)</b>	<b>€ 6891</b>	<b>€ 7891</b>	<b>€ 8675</b>	<b>€ 9956</b>	<b>€ 10634</b>	460mm
#m <sup>2</sup> sheets	8.8	11.8	14.7	17.6	20.6	
<b>3240 (3500mm support incl.)</b>	<b>€ 7057</b>	<b>€ 8098</b>	<b>€ 9060</b>	<b>€ 10243</b>	<b>€ 10960</b>	460mm
#m <sup>2</sup> sheets	10.3	13.7	17.2	20.6	24.0	
<b>3740 (4000mm support incl.)</b>	<b>€ 8207</b>	<b>€ 9635</b>	<b>€ 10367</b>	<b>€ 11693</b>	<b>€ 12450</b>	535mm
#m <sup>2</sup> sheets	11.8	15.7	19.6	23.5	27.4	
<b>4240 (4500mm support incl.)</b>	<b>€ 8777</b>	<b>€ 10285</b>	<b>€ 11096</b>	<b>€ 12501</b>	<b>€ 13696</b>	610mm
#m <sup>2</sup> sheets	13.2	17.6	22.1	26.5	30.9	
<b>front posts VS back posts</b>	<b>2 &amp; 2 posts</b>		<b>3 &amp; 2 posts</b>		<b>3 &amp; 3 posts</b>	

**Please note: these prices are indicative and not binding!**

The front posts below the gutter are 150 x 150mm. The back posts below the GDx are 110 x 110mm. All posts must be concreted into the ground at least 40cm deep.

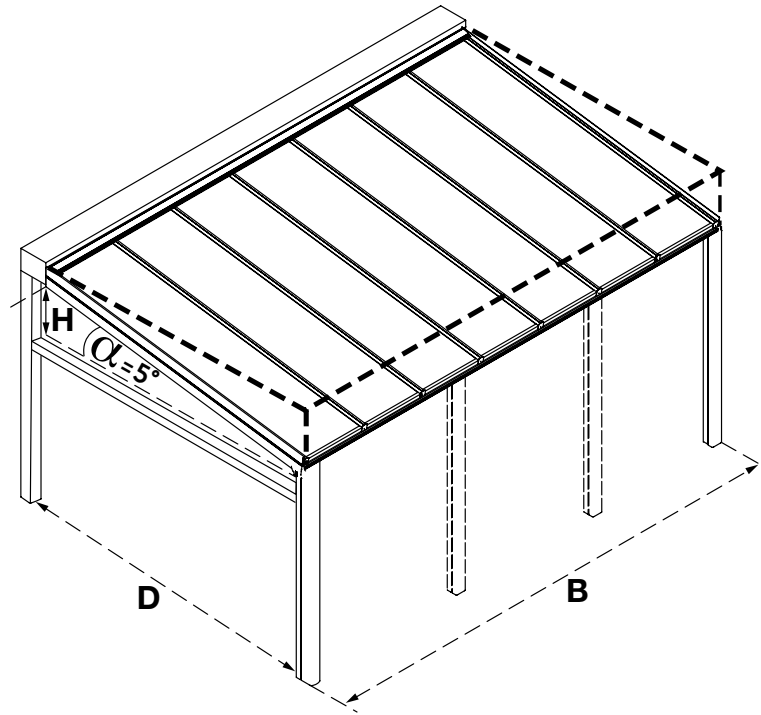

For glass – freestanding

CLIMALUX WITH CLIMACROWN FREESTANDING prepared for 8mm LSG (850N/m <sup>2</sup> snow load & 5° pitch)						
Width 'B' (in mm) → ↓ Depth 'D' (in mm)	3000	4000	5000	6000	7000	Climacrown height
2240 (2500mm support incl.) #m <sup>2</sup> glass panels	€ 6454 6.5	€ 7927 8.7	€ 8520 10.7	€ 9568 13.1	€ 10430 15.0	385mm
2740 (3000mm support incl.) #m <sup>2</sup> glass panels	€ 7151 7.9	€ 8735 10.6	€ 9376 13.3	€ 10506 16.0	€ 11408 18.7	460mm
3240 (3500mm support incl.) #m <sup>2</sup> glass panels	€ 7357 9.3	€ 9022 12.5	€ 9702 15.7	€ 10872 18.9	€ 12355 22.1	460mm
3740 (4000mm support incl.) #m <sup>2</sup> glass panels	€ 8547 10.8	€ 10368 14.4	€ 11089 18.1	€ 12640 21.8	€ 13924 25.5	535mm
front posts VS back posts	2 & 2 posts		3 & 2 posts	3 & 3 posts		
# of glass panels	4	6	7	8	9	

Please note: these prices are indicative and not binding!

The front posts below the gutter are 150 x 150mm. The back posts below the GDX are 110 x 110mm. All posts must be concreted into the ground at least 40cm deep.

Roof systems with glass and sandwich panels are now also available with a slope of 2°. Prices can be calculated on request with Climafast.

- For the optional LED lighting: see page 74

Option: surcharge for version with LED lighting						
Width 'B' (in mm) → ↓ Depth 'D' (in mm)	3000	4000	5000	6000	7000	Climacrown height
2240 (2500mm incl. support)	€ 853	€ 864	€ 1022	€ 1095	€ 1168	385mm
2740 (3000mm incl. support)	€ 864	€ 876	€ 1033	€ 1106	€ 1179	460mm
3240 (3500mm incl. support)	€ 864	€ 876	€ 1033	€ 1106	€ 1179	460mm
3740 (4000mm incl. support)	€ 876	€ 887	€ 1044	€ 1118	€ 1179	535mm
4240 (4500mm incl. support)	€ 1022	€ 1033	€ 1191	€ 1264	€ 1337	535mm

## SELF-SUPPORTING NON-THERMAL PROFILE SYSTEM (cold roof)

### CLIMAX PANORAMA (cold roof)

Climax Panorama offers numerous possibilities as a self-supporting patio roof or canopy.

Thanks to the innovative GDG gutter profile, where the gutter and gutter support have been designed as a single unit, Climax Panorama is self-supporting up to 7m in width between two posts (with 16mm plastic sheets and a depth of 3m). This will give you an attractive 'panoramic look', without intermediate posts to spoil the view. It is self-supporting up to 6m in depth. The roof pitch varies between 2° and 20° and starting from 5° with multi-walled sheets.

- 2 standard RAL colours: white RAL 9010 & anthracite RAL 7016 ST. Delivery time: max. 3 weeks.
- 8 "trend" RAL colours: cream white RAL 9001, black RAL 9005 ST, white aluminium RAL 9006 ST, grey aluminium RAL 9007 ST, RAL 9009 ST (DB703), RAL 9010 ST, purple red RAL 3004 ST & RAL 7039 ST. Surcharge: € 200 net. Delivery time: on request.
- Other RAL colours: see p. 8 & 9 (price on request). Delivery time: on request.

Climaled can be provided in the Panorama gutter or below the rafter (see p. 74). This LED lighting emits a soft and pleasant light.





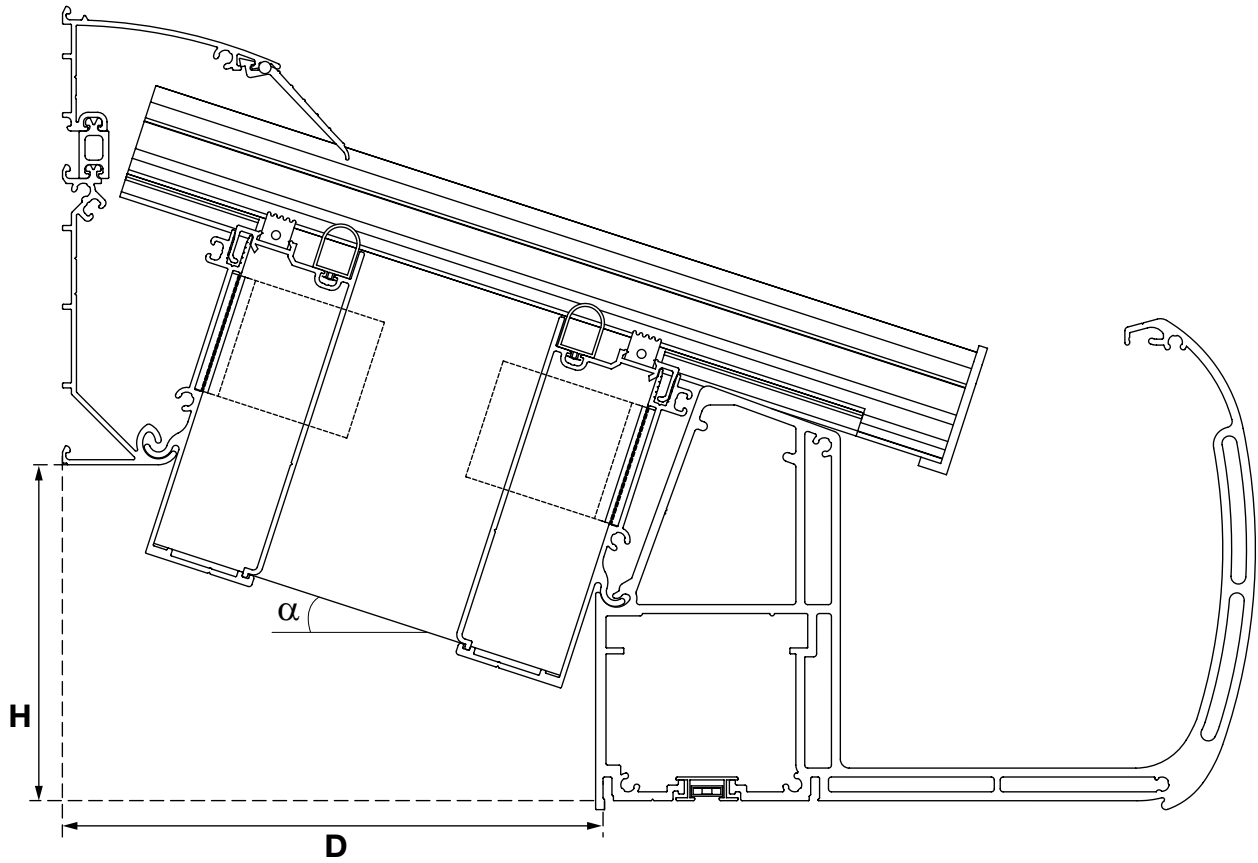

### Options

- Width B:  $\infty$
- Depth D: max. 5.5m
- Roof pitch  $\alpha$  between 2° and 20° and starting from 5° with multi-walled sheets

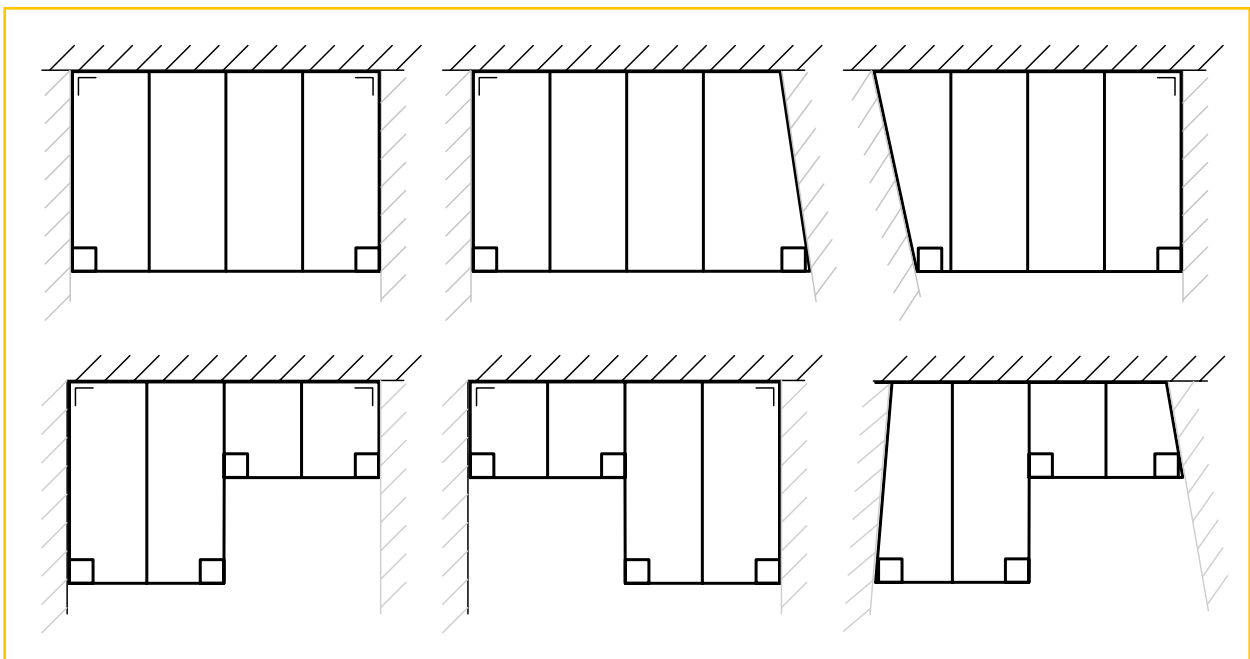

## Quick calculator Climax Panorama

Info:

- Aluminium profile system with Panorama gutter and aluminium clips (screwable for glass)
- 2, 3 or 4 posts 110 x 181 x 2500mm are included in the price
- 2 standard RAL colours: white RAL 9010 & anthracite RAL 7016 ST – delivery time: max. 3 weeks.
- 8 “trend” RAL colours: cream white RAL 9001, black RAL 9005 ST, white aluminium RAL 9006 ST, grey aluminium RAL 9007 ST, RAL 9009 ST (DB703), RAL 9010 ST, purple red RAL 3004 ST & RAL 7039 ST – surcharge: € 200 net – delivery time: on request.
- Other RAL colours: see p. 8 & 9 (price on request) – delivery time: on request.
- Plastic sheets or glass not included in the price
- Maximum deflection of the profiles: 1/200 for sheets and 8mm glass
- Drainpipe and accessories included

Calculate the price as follows:

- Measure the roof’s width B (mm) and depth D (mm).
- Select the next size up in the table and read off the prices of the profiles.
- Multiply the sheet or glass area, indicated in the same box, by the price/m<sup>2</sup> of the sheet or the glass (not supplied by Skylux).

### For 16mm sheets

CLIMAX PANORAMA prepared for 16mm thick and 980mm wide multi-walled sheets (650N/m <sup>2</sup> snow load & pitch 5°)								
Width ‘B’ (in mm) → ↓ Depth ‘D’ (in mm)	3000	4000	5000	6000	7000	8000	9000	10000
<b>2319 (2500mm incl. support)</b>	€ 3560	€ 3990	€ 4447	€ 5174	€ 5593	€ 6899	€ 7640	€ 8017
#m <sup>2</sup> sheets	7.4	9.8	12.3	14.7	17.2	19.6	22.1	24.1
<b>2819 (3000mm incl. support)</b>	€ 3710	€ 4153	€ 4668	€ 5409	€ 5885	€ 7204	€ 8003	€ 8393
#m <sup>2</sup> sheets	8.8	11.8	14.7	17.6	20.6	23.5	26.5	29.4
<b>3319 (3500mm incl. support)</b>	€ 3864	€ 4321	€ 4895	€ 5649	€ 6568	€ 7517	€ 8375	€ 8779
#m <sup>2</sup> sheets	10.3	13.7	17.2	20.6	24.0	27.4	30.9	34.3
<b>3819 (4000mm incl. support)</b>	€ 4014	€ 4506	€ 5116	€ 5905	€ 6847	€ 7843	€ 8737	€ 9176
#m <sup>2</sup> sheets	11.8	15.7	19.6	23.5	27.4	31.4	35.3	39.2
<b>4319 (4500mm incl. support)</b>	€ 4317	€ 4880	€ 5560	€ 6419	€ 7433	€ 8498	€ 9463	€ 9973
#m <sup>2</sup> sheets	13.2	17.6	22.1	26.5	30.9	35.3	39.7	44.1
<b>4819 (5000mm incl. support)</b>	€ 5347	€ 6167	€ 7104	€ 8222	€ 9493	€ 10816	€ 12038	€ 12805
#m <sup>2</sup> sheets	14.7	19.6	24.5	29.4	34.3	39.2	44.1	49.0
<b>5319 (5500mm incl. support)</b>	€ 5659	€ 6553	€ 7564	€ 9129	€ 10100	€ 11498	€ 12794	€ 13633
#m <sup>2</sup> sheets	17.6	23.5	29.4	35.3	41.2	47.0	52.9	58.8
<b>Number of supports*</b>	<b>2 supports</b>				<b>3 supports</b>			

**Please note: these prices are indicative and not binding!**

\* For larger spans: see quick calculator with steel reinforcement (p. 36 & 37)

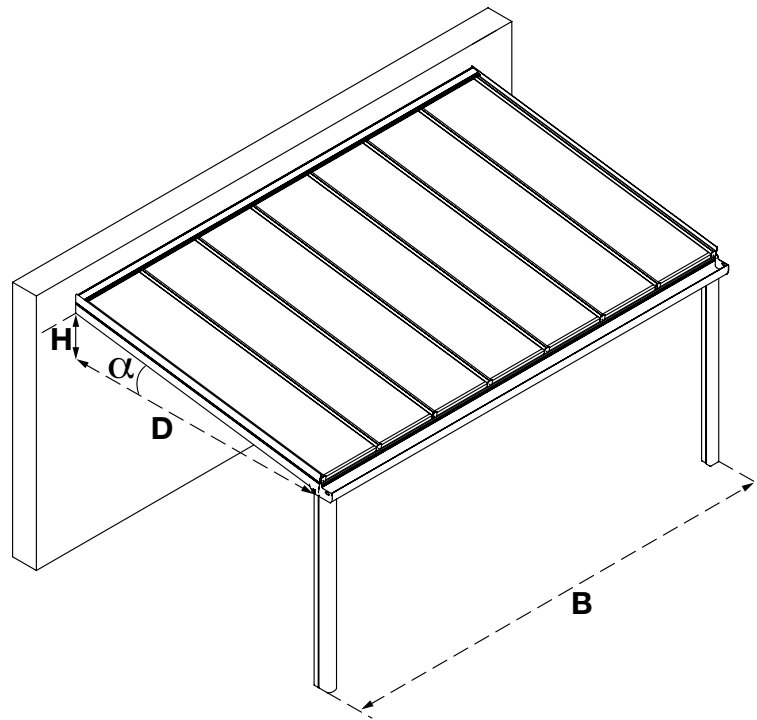

For glass

CLIMAX PANORAMA prepared for 8mm LSG (850N/m <sup>2</sup> snow load & pitch 5°)								
Width 'B' (in mm) → ↓ Depth 'D' (in mm)	3000	4000	5000	6000	7000	8000	9000	10000
<b>2319 (2500mm incl. support)</b>	€ 4060	€ 4729	€ 5169	€ 5953	€ 6812	€ 7998	€ 8879	€ 9116
#m <sup>2</sup> glass panels	6.9	9.2	11.5	13.9	16.2	18.5	20.8	23.2
<b>2819 (3000mm incl. support)</b>	€ 4231	€ 4977	€ 5498	€ 6296	€ 7218	€ 8481	€ 9367	€ 9676
#m <sup>2</sup> glass panels	8.3	11.1	13.9	16.8	19.6	22.4	25.2	28.1
<b>3319 (3500mm incl. support)</b>	€ 4408	€ 5232	€ 5818	€ 6983	€ 7623	€ 8963	€ 9854	€ 10238
#m <sup>2</sup> glass panels	9.7	13.0	16.3	19.7	23.0	24.8	29.6	32.9
<b>3819 (4000mm incl. support)</b>	€ 4604	€ 5508	€ 6155	€ 7346	€ 8032	€ 9460	€ 10375	€ 10813
#m <sup>2</sup> glass panels	11.2	14.9	18.8	22.6	26.4	30.2	34.0	37.8
<b>4319 (4500mm incl. support)</b>	€ 5023	€ 6082	€ 6806	€ 8072	€ 8838	€ 10401	€ 11392	€ 11904
#m <sup>2</sup> glass panels	12.6	16.8	21.2	25.5	29.8	34.0	38.4	42.7
<b>4819 (5000mm incl. support)</b>	€ 6310	€ 7885	€ 8868	€ 10393	€ 11422	€ 13512	€ 14770	€ 15543
#m <sup>2</sup> glass panels	14.1	18.8	23.6	28.4	33.3	37.9	42.8	47.6
<b>5319 (5500mm incl. support)</b>	€ 6736	€ 8479	€ 9915	€ 11150	€ 12259	€ 14506	€ 15841	€ 17260
#m <sup>2</sup> glass panels	15.5	20.7	26.0	31.3	36.7	41.8	47.1	52.4
<b>Number of supports*</b>	2 supports		3 supports				4 supports	
# of glass panels	4	6	7	8	9	11	12	13

Please note: these prices are indicative and not binding!

Roof systems with glass and sandwich panels are now also available with a slope of 2°. Prices can be calculated on request with Climafast.

\* For larger spans: see quick calculator with steel reinforcement (p. 36 & 37)

## Quick calculator Climax Panorama with IPE120 steel reinforcement in the gutter (standard colour & 5° pitch) (IPE120 not included in the price)

Info:

- Aluminium profile system with Panorama gutter and aluminium clips (screwable for glass)
- 2 or 3 posts 110 x 181 x 2500mm are included in the price
- 2 standard RAL colours: white RAL 9010 & anthracite RAL 7016 ST – delivery time: max. 3 weeks.
- 8 “trend” RAL colours: cream white RAL 9001, black RAL 9005 ST, white aluminium RAL 9006 ST, grey aluminium RAL 9007 ST, RAL 9009 ST (DB703), RAL 9010 ST, purple red RAL 3004 ST & RAL 7039 ST – surcharge: € 200 net – delivery time: on request.
- Other RAL colours: see p. 8 & 9 (price on request) – delivery time: on request.
- Plastic sheets or glass not included in the price
- Maximum deflection of the profiles: 1/200 for sheets and 8mm glass
- Drainpipe and accessories included

Calculate the price as follows:

- Measure the roof's width B (mm) and depth D (mm).
- Select the next size up in the table and read off the prices of the profiles.
- Multiply the sheet or glass area, indicated in the same box, by the price/m<sup>2</sup> of the sheet or the glass (not supplied by Skylux).

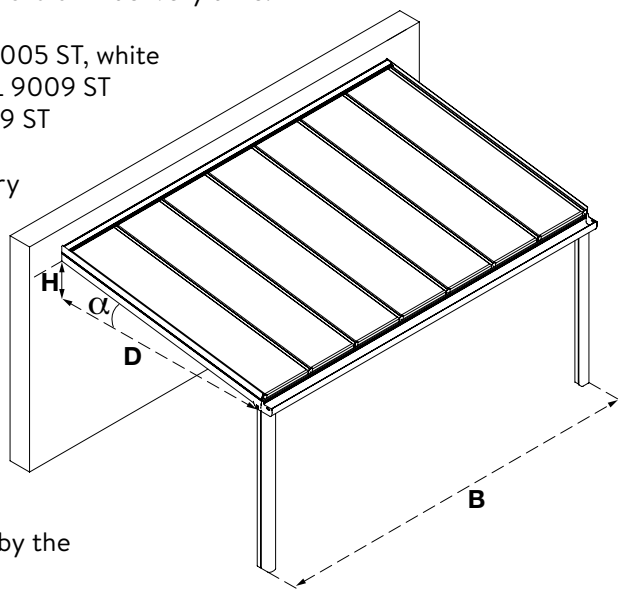

### For 16mm sheets

CLIMAX PANORAMA prepared for 16mm thick and 980mm wide multi-walled sheets (650N/m <sup>2</sup> snow load & pitch 5°)					
Width 'B' (in mm) → ↓ Depth 'D' (in mm)	6000	7000	8000	9000	10000
<b>2319 (2500mm incl. support)</b>	€ 5314	€ 5754	€ 7224	€ 7952	€ 8329
#m <sup>2</sup> sheets	14.7	17.2	19.6	22.1	24.1
<b>2819 (3000mm incl. support)</b>	€ 5549	€ 6045	€ 7528	€ 8314	€ 8705
#m <sup>2</sup> sheets	17.6	20.6	23.5	26.5	29.4
<b>3319 (3500mm incl. support)</b>	€ 5789	€ 6344	€ 7842	€ 8687	€ 9090
#m <sup>2</sup> sheets	20.6	24.0	27.4	30.9	34.3
<b>3819 (4000mm incl. support)</b>	€ 6045	€ 6636	€ 8167	€ 9048	€ 9488
#m <sup>2</sup> sheets	23.5	27.4	31.4	35.3	39.2
<b>4319 (4500mm incl. support)</b>	€ 6559	€ 7221	€ 8823	€ 9774	€ 10285
#m <sup>2</sup> sheets	26.5	30.9	35.3	39.7	44.1
<b>4819 (5000mm incl. support)</b>	€ 8362	€ 9281	€ 11141	€ 12350	€ 13117
#m <sup>2</sup> sheets	29.4	34.3	39.2	44.1	49.0
<b>5319 (5500mm incl. support)</b>	€ 8896	€ 9889	€ 11823	€ 13106	€ 13945
#m <sup>2</sup> sheets	35.3	41.2	47.0	52.9	58.8
<b>Number of supports</b>	<b>2 supports</b>		<b>3 supports</b>		

Please note: these prices are indicative and not binding!

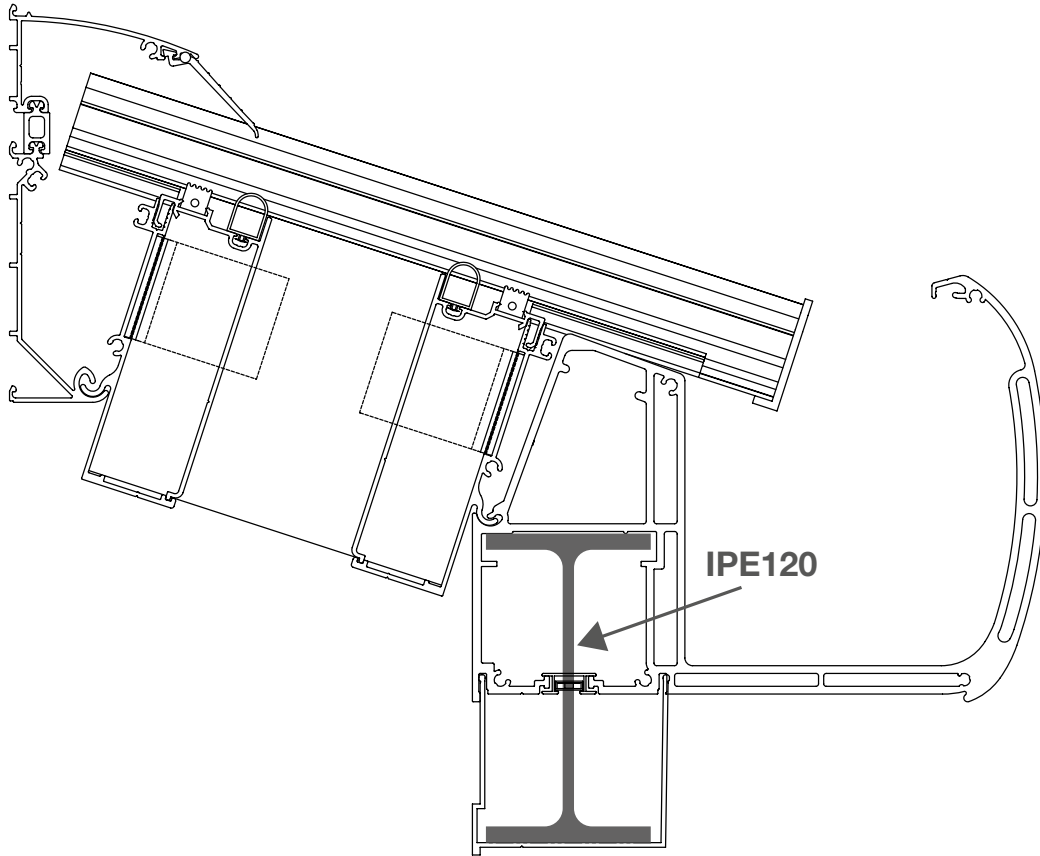

For glass

CLIMAX PANORAMA prepared for 8mm LSG (850N/m <sup>2</sup> snow load & pitch 5°)					
Width 'B' (in mm) → ↓ Depth 'D' (in mm)	6000	7000	8000	9000	10000
<b>2319 (2500mm incl. support)</b>	€ 6093	€ 6600	€ 8321	€ 9191	€ 9428
#m <sup>2</sup> glass panels	13.9	16.2	18.5	20.8	23.2
<b>2819 (3000mm incl. support)</b>	€ 6419	€ 7005	€ 8805	€ 9677	€ 9988
#m <sup>2</sup> glass panels	16.8	19.6	22.4	25.2	28.1
<b>3319 (3500mm incl. support)</b>	€ 6750	€ 7411	€ 9288	€ 10165	€ 10549
#m <sup>2</sup> glass panels	19.7	23.0	24.8	29.6	32.9
<b>3819 (4000mm incl. support)</b>	€ 7113	€ 8226	€ 9784	€ 10687	€ 11125
#m <sup>2</sup> glass panels	22.6	26.4	30.2	34.0	37.8
<b>4319 (4500mm incl. support)</b>	€ 7839	€ 9031	€ 10725	€ 11704	€ 12216
#m <sup>2</sup> glass panels	25.5	29.8	34.0	38.4	42.7
<b>4819 (5000mm incl. support)</b>	€ 10160	€ 11615	€ 13837	€ 15082	€ 15855
#m <sup>2</sup> glass panels	28.4	33.3	37.9	42.8	47.6
<b>5319 (5500mm incl. support)</b>	€ 10917	€ 12453	€ 14831	€ 16153	€ 16998
#m <sup>2</sup> glass panels	31.3	36.7	41.8	47.1	52.4
<b>Number of supports</b>	2 supports		3 supports		
# of glass panels	8	9	11	12	13

Please note: these prices are indicative and not binding!

Roof systems with glass are now also available with a slope of 2°. Prices can be calculated on request with Climafast.

## Quick calculator Climax Panorama freestanding roof

A Climax Panorama roof system can also be installed as a freestanding patio roof instead of against a wall. A freestanding patio roof does not need any supporting walls and can be placed anywhere in your garden. As with all Climalux systems, the detached version combines with plastic sheets (16 or 32mm) or glass. To guarantee the stability of a freestanding patio roof, the posts must be concreted into the ground according to our instructions.

### For 16mm sheets – freestanding

CLIMAX PANORAMA FREESTANDING prepared for 16mm thick and 980mm wide multi-walled sheets (650N/m <sup>2</sup> snow load & 5° pitch)					
Width 'B' (in mm) → ↓ Depth 'D' (in mm)	3000	4000	5000	6000	7000
<b>2209 (2500mm support incl.)</b>	<b>€ 5606</b>	<b>€ 6283</b>	<b>€ 6751</b>	<b>€ 7654</b>	<b>€ 8247</b>
#m <sup>2</sup> sheets	6.9	9.4	11.8	13.7	16.2
<b>2709 (3000mm support incl.)</b>	<b>€ 5851</b>	<b>€ 6542</b>	<b>€ 7066</b>	<b>€ 7983</b>	<b>€ 8632</b>
#m <sup>2</sup> sheets	8.8	11.8	14.7	17.6	20.6
<b>3209 (3500mm support incl.)</b>	<b>€ 6005</b>	<b>€ 6709</b>	<b>€ 7292</b>	<b>€ 8222</b>	<b>€ 9572</b>
#m <sup>2</sup> sheets	10.3	13.7	17.2	20.6	24.0
<b>3709 (4000mm support incl.)</b>	<b>€ 6615</b>	<b>€ 7354</b>	<b>€ 7973</b>	<b>€ 8938</b>	<b>€ 10323</b>
#m <sup>2</sup> sheets	11.8	15.7	19.6	23.5	27.4
<b>front posts VS back posts*</b>	<b>2 &amp; 2 posts</b>				<b>3 &amp; 2 posts</b>
<b>4209 (4500mm support incl.)</b>	<b>€ 6917</b>	<b>€ 7727</b>	<b>€ 8417</b>	<b>€ 9452</b>	<b>€ 11264</b>
#m <sup>2</sup> sheets	13.2	17.6	22.1	26.5	30.9
<b>4709 (5000mm support incl.)</b>	<b>€ 6917</b>	<b>€ 7727</b>	<b>€ 8417</b>	<b>€ 9452</b>	<b>€ 11264</b>
#m <sup>2</sup> sheets	14.7	19.6	24.5	29.4	34.3
<b>front posts VS back posts</b>	<b>2 &amp; 2 posts</b>				<b>3 &amp; 3 posts</b>

**Please note: these prices are indicative and not binding!**

The front posts below the gutter are 150 x 181mm. The back posts below the GDG are 110 x 110mm. All posts must be concreted into the ground at least 40cm deep.

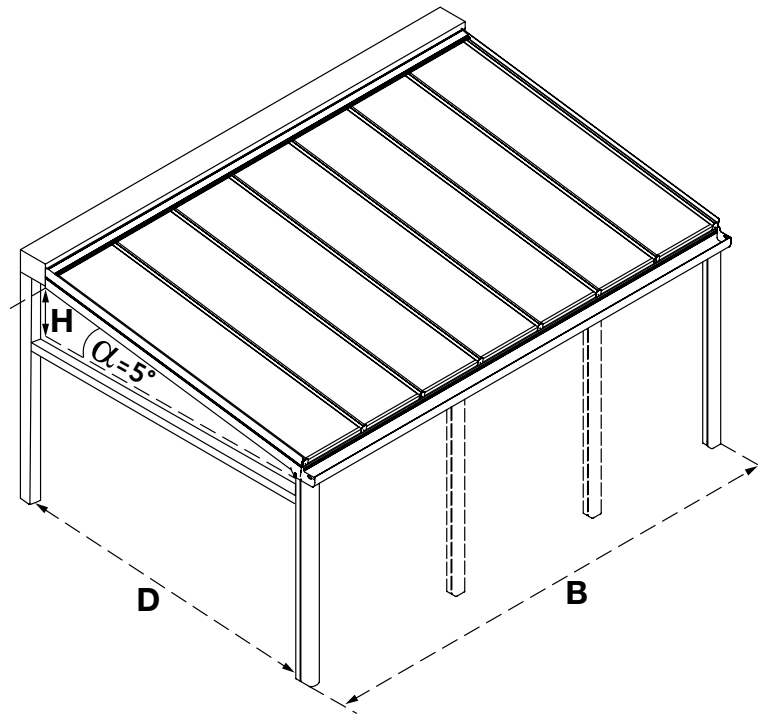

For glass – freestanding

CLIMAX PANORAMA FREESTANDING prepared for 8mm LSG (850N/m <sup>2</sup> snow load & 5° pitch)					
Width 'B' (in mm) → ↓ Depth 'D' (in mm)	3000	4000	5000	6000	7000
<b>2209 (2500mm support incl.)</b>	€ 6100	€ 7008	€ 7474	€ 8391	€ 9728
#m <sup>2</sup> glass panels	6.5	8.7	10.9	13.2	15.4
<b>front posts VS back posts*</b>	2 & 2 posts				3 & 2 posts
<b>2709 (3000mm support incl.)</b>	€ 6373	€ 7363	€ 7890	€ 8853	€ 10464
#m <sup>2</sup> glass panels	7.9	10.6	13.3	16.1	18.8
<b>3209 (3500mm support incl.)</b>	€ 6543	€ 7612	€ 8217	€ 9819	€ 10863
#m <sup>2</sup> glass panels	9.4	12.5	15.7	19.0	22.1
<b>3709 (4000mm support incl.)</b>	€ 7199	€ 8353	€ 9006	€ 10635	€ 11857
#m <sup>2</sup> glass panels	10.8	14.4	18.1	21.8	25.5
<b>front posts VS back posts*</b>	2 & 2 posts			3 & 2 posts	3 & 3 posts
<b>4209 (4500mm support incl.)</b>	€ 7612	€ 8921	€ 9658	€ 11715	€ 12650
#m <sup>2</sup> glass panels	12.2	16.3	20.5	24.7	28.9
<b>4709 (5000mm support incl.)</b>	€ 8931	€ 10769	€ 11770	€ 14095	€ 15298
#m <sup>2</sup> glass panels	13.7	18.3	22.9	27.6	32.3
<b>front posts VS back posts</b>	2 & 2 posts			3 & 3 posts	
# of glass panels	4	6	7	8	9

Please note: these prices are indicative and not binding!

The front posts below the gutter are 150 x 181mm. The back posts below the GDX are 110 x 110mm. All posts must be concreted into the ground at least 40cm deep.

Roof systems with glass are now also available with a slope of 2°. Prices can be calculated on request with Climafast.

## SELF-SUPPORTING THERMAL PROFILE SYSTEM (warm roof)

### CLIMAX

The self-supporting Climax system offers numerous possibilities: a roof between two walls, various shapes, gutter and post types, with and without integrated water drainage, finish with rubber strips, clips, various side finishes, oblique closure with side walls, etc. There is always a solution that's right for you.

Provided the raised GD2 gutter support is used, the Climax roof is self-supporting up to 7m in width between two posts (with 16mm plastic sheets and a depth of 3m). is self-supporting up to 5.5m in depth. The roof pitch is variable between 5° and 45°.

Both 16 and 32mm thick (insulating) plastic sheets or max. 34mm thick glass can be used as glazing for your thermal Climax roof.

- 2 standard RAL colours: white RAL 9010 & anthracite RAL 7016 ST. Delivery time: max. 3 weeks.
- 8 "trend" RAL colours: cream white RAL 9001, black RAL 9005 ST, white aluminium RAL 9006 ST, grey aluminium RAL 9007 ST, RAL 9009 ST (DB703), RAL 9010 ST, purple red RAL 3004 ST & RAL 7039 ST. Surcharge: € 200 net. Delivery time: on request.
- Other RAL colours: see p. 8 & 9 (price on request). Delivery time: on request.

Climax can also be provided with Climaled (see p. 74).





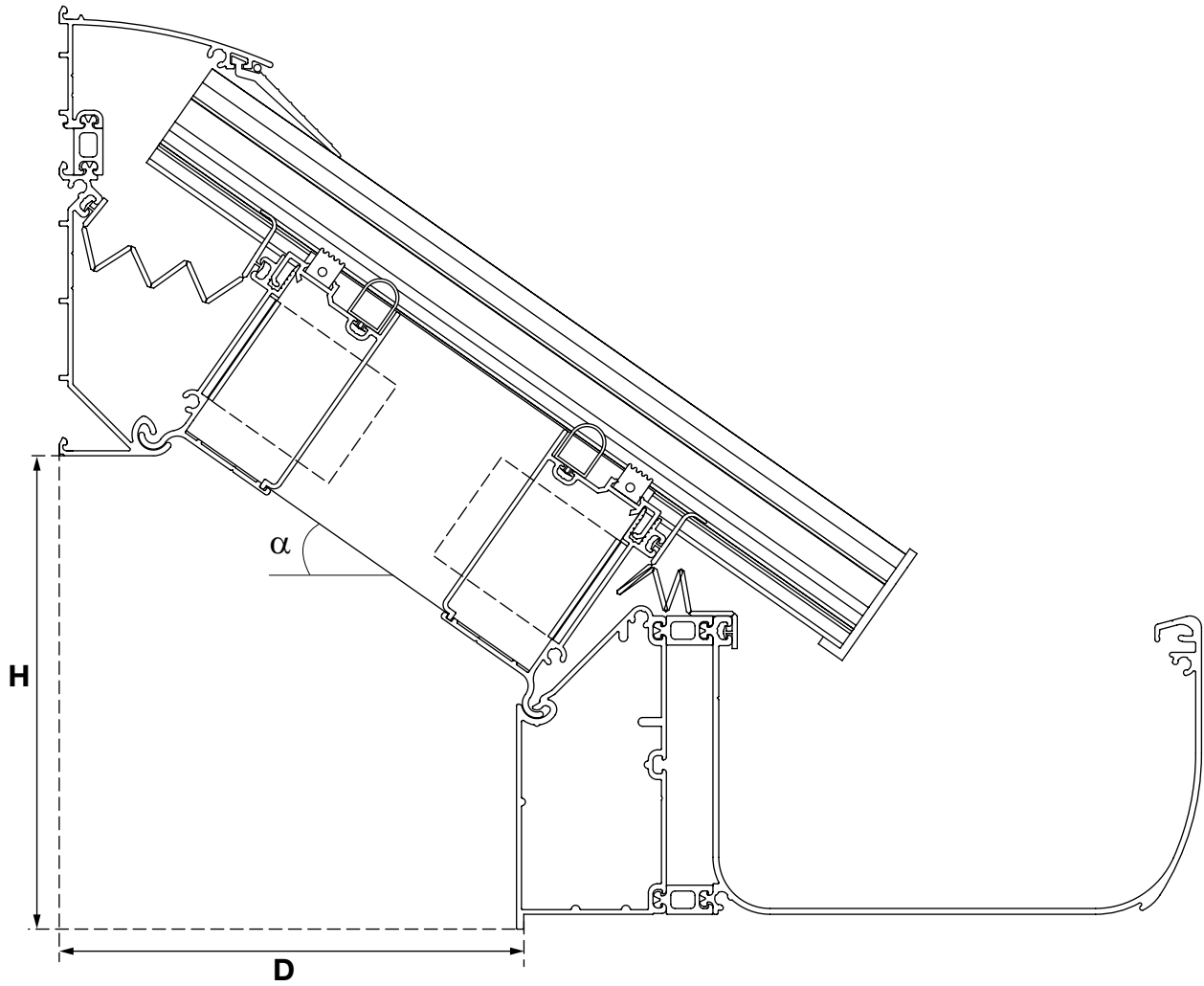

### Options

- Width B:  $\infty$
- Depth D: max. 5.5m
- Pitch  $\alpha$ : 5° to 45°

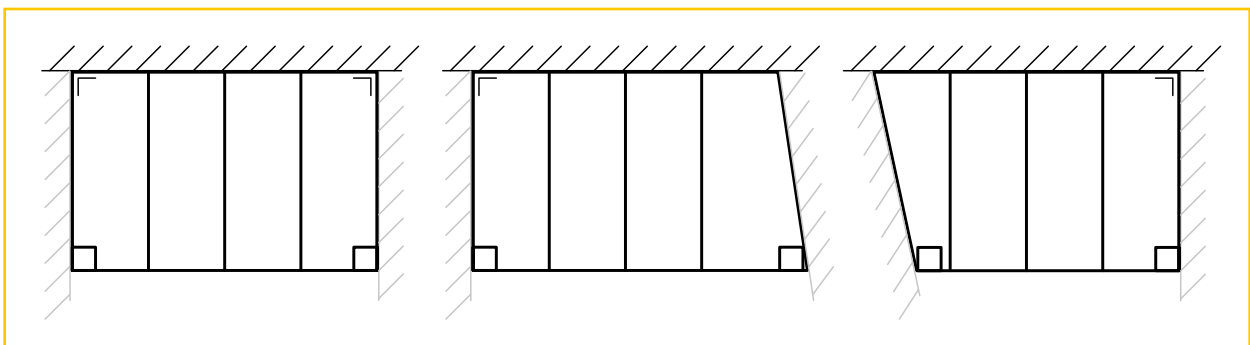

## Quick calculator Climax thermal

Info:

- Aluminium profile system with gutter G+GD2 and aluminium clips
- 2, 3 or 4 posts 110 x 197 x 2500mm are included in the price
- 2 standard RAL colours: white RAL 9010 & anthracite RAL 7016 ST – delivery time: max. 3 weeks.
- 8 “trend” RAL colours: cream white RAL 9001, black RAL 9005 ST, white aluminium RAL 9006 ST, grey aluminium RAL 9007 ST, RAL 9009 ST (DB703), RAL 9010 ST, purple red RAL 3004 ST & RAL 7039 ST – surcharge: € 200 net – delivery time: on request.
- Other RAL colours: see p. 8 & 9 (price on request) – delivery time: on request.
- Plastic sheets or glass not included in the price
- Maximum deflection of the profiles: 1/200
- Drainpipe and accessories included

Calculate the price as follows:

- Measure the roof’s width B (mm) and depth D (mm).
- Select the next size up in the table and read off the prices of the profiles.
- Multiply the sheet or glass area, indicated in the same box, by the price/m<sup>2</sup> of the sheet or the glass (not supplied by Skylux).

### For 32mm sheets

CLIMAX THERMAL (prepared for 32mm thick and 980mm wide multi-walled sheets) (650N/m <sup>2</sup> snow load & pitch 5°)								
Width 'B' (in mm) → ↓ Depth 'D' (in mm)	3000	4000	5000	6000	7000	8000	9000	10000
<b>2303 (2500mm incl. support)</b>	€ 3937	€ 4418	€ 4769	€ 5764	€ 6604	€ 7471	€ 7866	€ 8321
#m <sup>2</sup> sheets	7.4	9.8	12.3	14.7	17.2	19.6	22.1	24.5
<b>2803 (3000mm incl. support)</b>	€ 4097	€ 4594	€ 5001	€ 6312	€ 6907	€ 7789	€ 8241	€ 8712
#m <sup>2</sup> sheets	8.8	11.8	14.7	17.6	20.6	23.5	26.5	29.4
<b>3303 (3500mm incl. support)</b>	€ 4286	€ 4796	€ 5263	€ 6590	€ 6975	€ 8139	€ 8651	€ 9136
#m <sup>2</sup> sheets	10.3	13.7	17.2	20.6	24.0	27.4	30.9	34.3
<b>3803 (4000mm incl. support)</b>	€ 4545	€ 5112	€ 5634	€ 7015	€ 7456	€ 8675	€ 9243	€ 9782
#m <sup>2</sup> sheets	11.8	15.7	19.6	23.5	27.4	31.4	35.3	39.2
<b>4303 (4500mm incl. support)</b>	€ 5002	€ 5621	€ 6195	€ 7630	€ 8122	€ 9395	€ 10013	€ 10607
#m <sup>2</sup> sheets	13.2	17.6	22.1	26.5	30.9	35.3	39.7	44.1
<b>4803 (5000mm incl. support)</b>	€ 5589	€ 6475	€ 7620	€ 9020	€ 9781	€ 11322	€ 12208	€ 13674
#m <sup>2</sup> sheets	14.7	19.6	24.5	29.4	34.3	39.2	44.1	49.0
<b>5303 (5500mm incl. support)</b>	€ 5205*	€ 5896*	€ 6843*	€ 8080*	€ 8610*	€ 9956*	€ 10646*	€ 11914*
#m <sup>2</sup> sheets	17.6	23.5	29.4	35.3	41.2	47.0	52.9	58.8
<b>Number of supports (included)</b>	2 supports			3 supports				

**Please note: these prices are indicative and not binding!**

\* Please provide steel reinforcement V1044 in the rafters.

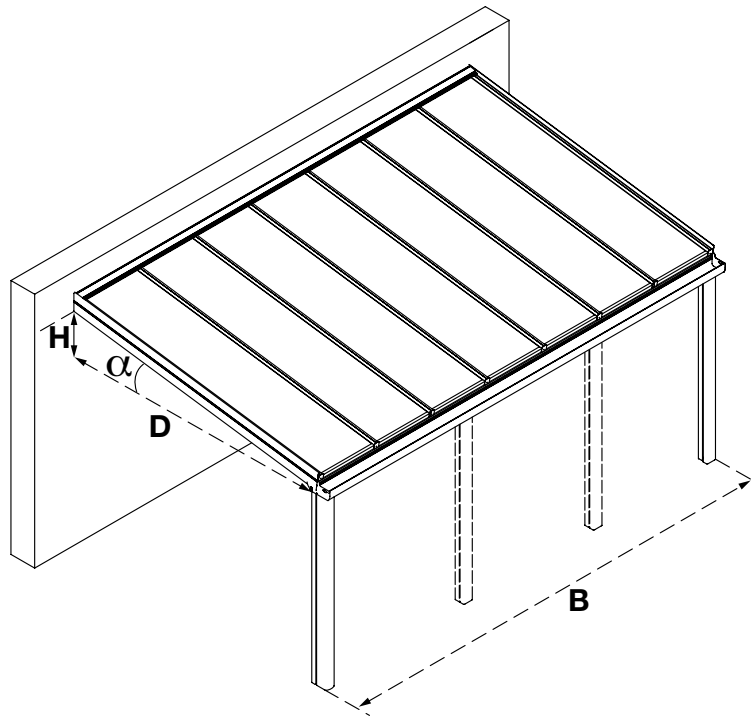

For glass

CLIMAX THERMAL (prepared for 32mm thick glass) (1000N/m <sup>2</sup> snow load & pitch 5°)								
Width 'B' (in mm) → ↓ Depth 'D' (in mm)	3000	4000	5000	6000	7000	8000	9000	10000
<b>2303 (2500mm incl. support)</b>	€ 4352	€ 5024	€ 5645	€ 6700	€ 6896	€ 8374	€ 8889	€ 9770
#m <sup>2</sup> glass panels	6.9	9.2	11.5	13.9	16.2	18.5	20.8	23.2
<b>2803 (3000mm incl. support)</b>	€ 4510	€ 5257	€ 5941	€ 7004	€ 7262	€ 8815	€ 9334	€ 10282
#m <sup>2</sup> glass panels	8.3	11.1	13.9	16.8	19.6	22.4	25.2	28.1
<b>3303 (3500mm incl. support)</b>	€ 4692	€ 5509	€ 6268	€ 7332	€ 7658	€ 9283	€ 10404	€ 10818
#m <sup>2</sup> glass panels	9.7	13.0	16.3	19.7	23.0	24.8	29.6	32.9
<b>3803 (4000mm incl. support)</b>	€ 4904	€ 5794	€ 6635	€ 7682	€ 8064	€ 9760	€ 10905	€ 11474
#m <sup>2</sup> glass panels	11.2	14.9	18.8	22.6	26.4	30.2	34.0	37.8
<b>4303 (4500mm incl. support)</b>	€ 6264	€ 8092	€ 8949	€ 10323	€ 11023	€ 13959	€ 14820	€ 15713
#m <sup>2</sup> glass panels	12.6	16.8	21.2	25.5	29.8	34.0	38.4	42.7
<b>4803 (5000mm incl. support)</b>	€ 5507*	€ 6838*	€ 7446*	€ 8570*	€ 9022*	€ 11461*	€ 12072*	€ 12716*
#m <sup>2</sup> glass panels	14.1	18.8	23.6	28.4	33.3	37.9	42.8	47.6
<b>Number of supports (included)</b>	2 supports			3 supports			4 supports	
# glass panels	4	6	7	8	9	11	12	13

Please note: these prices are indicative and not binding!

Roof systems with glass are now also available with a slope of 2°. Prices can be calculated on request with Climafast.

\* Please provide steel reinforcement V1044 in the rafters.

## Price list profiles and accessories for Climax, Climalux, Climacrown, Triangle, Windbreak, Climaglide and Vertical Sunblind

### 1. Profiles

GROUP	TYPE	DESCRIPTION	LENGTH	ARTICLE NUMBER				UN.	PRICE / UNIT		
				0	9010	7016 ST	RAL		0	STANDARD COLOURS	RAL *
<b>M</b>	<b>WALL PROFILES</b>	MX Wall profile Climalux	3.5	34807	34822	34826	34830	m	€ 38.24	€ 43.98	€ 50.58
			4	36522	36525	36528	36593	m	€ 38.24	€ 43.98	€ 50.58
			5	34819	34823	34827	34831	m	€ 38.24	€ 43.98	€ 50.58
			6	34820	34824	34828	34832	m	€ 38.24	€ 43.98	€ 50.58
			7	34821	34825	34829	34833	m	€ 38.24	€ 43.98	€ 50.58
		MX32 Wall profile Climalux	3.5	60372	60375	60374	60373	m	€ 41.30	€ 47.48	€ 54.60
			4	60376	60379	60378	60377	m	€ 41.30	€ 47.48	€ 54.60
			5	60380	60383	60382	60381	m	€ 41.30	€ 47.48	€ 54.60
			6	60384	60387	60386	60385	m	€ 41.30	€ 47.48	€ 54.60
			7	60388	60391	60390	60389	m	€ 41.30	€ 47.48	€ 54.60
		MT Wall profile top	3.5	21342	21348	31205	21351	m	€ 16.60	€ 19.68	€ 22.63
			4.25	23376	23379	31206	23378	m	€ 16.60	€ 19.68	€ 22.63
			5	21343	21349	31207	21352	m	€ 16.60	€ 19.68	€ 22.63
			7	21344	21350	31208	21353	m	€ 16.60	€ 19.68	€ 22.63
		MB Wall profile bottom	3.5	21354	21360	31109	21363	m	€ 24.04	€ 27.62	€ 31.76
	4.25		23380	23383	31110	23382	m	€ 24.04	€ 27.62	€ 31.76	
	5		21355	21361	31111	21364	m	€ 24.04	€ 27.62	€ 31.76	
	7		21356	21362	31112	21365	m	€ 24.04	€ 27.62	€ 31.76	
	S1 Hinge profile S1	3.5	21366	21372	31117	21375	m	€ 16.83	€ 19.35	€ 22.25	
		4.25	23384	23387	31118	23386	m	€ 16.83	€ 19.35	€ 22.25	
		5	21367	21373	31119	21376	m	€ 16.83	€ 19.35	€ 22.25	
7		21368	21374	31120	21377	m	€ 16.83	€ 19.35	€ 22.25		
S2 Hinge profile S2	3.5	23479	23488	31121	23485	m	€ 22.99	€ 26.43	€ 30.39		
	5	23480	23489	31122	23486	m	€ 22.99	€ 26.43	€ 30.39		
	7	23481	23490	31123	23487	m	€ 22.99	€ 26.43	€ 30.39		

GROUP	TYPE	DESCRIPTION	LENGTH	ARTICLE NUMBER				UN.	PRICE / UNIT		
				0	9010	7016 ST	RAL		0	STANDARD COLOURS	RAL *
<b>G</b>	<b>GUTTERS</b>	GX Gutter Climalux	3.5	34834	34838	34842	34846	m	€ 106.10	€ 122.01	€ 140.31
			4	36513	36516	36519	36590	m	€ 106.10	€ 122.01	€ 140.31
			5	34835	34839	34843	34847	m	€ 106.10	€ 122.01	€ 140.31
			6	34836	34840	34844	34848	m	€ 106.10	€ 122.01	€ 140.31
			7	34837	34841	34845	34849	m	€ 106.10	€ 122.01	€ 140.31
	GLX Ornamental profile Climalux for gutter	3.5	34850	34853	34856	34859	m	€ 65.39	€ 75.19	€ 86.47	
		5	34851	34854	34857	34860	m	€ 65.39	€ 75.19	€ 86.47	
		6	36550	36551	36552	36553	m	€ 65.39	€ 75.19	€ 86.47	
		7	34852	34855	34858	34861	m	€ 65.39	€ 75.19	€ 86.47	
	GIX Connecting piece Climalux for GX	0.3	35703				pc	€ 59.00			







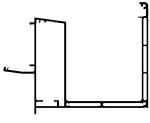
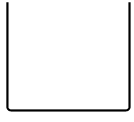
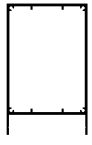
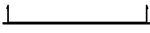

#### FINISHING

0: mill-finished aluminium or standard

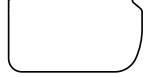
RAL 9010 white / RAL 7016 ST anthracite structure: in stock (delivery time 3 weeks)

Other standard RAL colours: start up costs of € 200 net for each colour (delivery time on request)

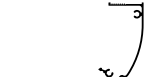
\* any other RAL colour: +15% and start up cost of € 200 net for each colour (delivery time on request)

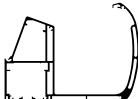
GROUP	TYPE	DESCRIPTION	LENGTH	ARTICLE NUMBER				UN.	PRICE / UNIT		
G	GUTTERS		M	0	9010	7016 ST	RAL		0	STANDARD COLOURS	RAL *
	GXLX	Gutter XL Climalux Horizon	5	71505	71508	71507	71506	m	€ 153.74	€ 179.85	€ 206.83
			6	71509	71512	71511	71510	m	€ 153.74	€ 179.85	€ 206.83
			7	71513	71516	71515	71514	m	€ 153.74	€ 179.85	€ 206.83
	GIXL	Connecting piece Climalux for GXLX	0.3	71991				pc	€ 23.44		
	GDY	Cross-beam Climalux for overhang	3.5	51834	51836	51835	51862	m	€ 121.20	€ 135.30	€ 155.60
			5	51837	51839	51838	51863	m	€ 121.20	€ 135.30	€ 155.60
			6	51840	51842	51841	51864	m	€ 121.20	€ 135.30	€ 155.60
			7	51843	51845	51844	51865	m	€ 121.20	€ 135.30	€ 155.60
	GDCX	Clip profile Climalux for cross-beam GDY	3.5	51846	51849	51848	51847	m	€ 22.55	€ 24.87	€ 28.60
			5	51850	51853	51852	51851	m	€ 22.55	€ 24.87	€ 28.60
			6	51854	51857	51856	51855	m	€ 22.55	€ 24.87	€ 28.60
			7	51858	51861	51860	51859	m	€ 22.55	€ 24.87	€ 28.60
	G	Gutter Climax	3.5	21385	21391	31214	21394	m	€ 49.78	€ 57.25	€ 65.84
			4.25	23388	23391	31215	23390	m	€ 49.78	€ 57.25	€ 65.84
			5	21386	21392	31216	21395	m	€ 49.78	€ 57.25	€ 65.84
			7	21387	21393	31217	21396	m	€ 49.78	€ 57.25	€ 65.84
	GI	Internal gutter for G	7	27286				m	€ 36.01		
	GI 0	Connecting piece for G	0.3	27732				pc	€ 27.81		
	GI 90	Outside corner piece 90°		27559				pc	€ 81.49		
	GI 120	Outside corner piece 120°		27560				pc	€ 81.49		
	GI 135	Outside corner piece 135°		27561				pc	€ 81.49		
	GI 150	Outside corner piece 150°		27562				pc	€ 81.49		
	GI -90	Inside corner piece 90°		27563				pc	€ 81.49		
	GIP	Connecting piece for GDG	0.5	35884				pc	€ 131.03		
	GD1	Gutter support GD1	3.5	21397	21403	31218	21406	m	€ 33.10	€ 38.08	€ 43.79
			4.25	23392	23395	31219	23394	m	€ 33.10	€ 38.08	€ 43.79
			5	21398	21404	31220	21407	m	€ 33.10	€ 38.08	€ 43.79
			7	21399	21405	31221	21408	m	€ 33.10	€ 38.08	€ 43.79
	GD2	Gutter support GD2	5	27271	27280	31126	27284	m	€ 91.85	€ 96.33	€ 110.78
			7	27272	27281	31127	27285	m	€ 91.85	€ 96.33	€ 110.78
	PL165	Steel plate 160 x 5 galvanised	6.15	36335				m	€ 50.77		
	GD2C	Cover for gutter support GD2	5	27309	27317	31136	27321	m	€ 26.86	€ 35.08	€ 40.34
			7	27310	27318	31137	27322	m	€ 26.86	€ 35.08	€ 40.34
	GDP	Thermal profile for GD2	6	27338				m	€ 12.36		
	GDG	Self-supporting gutter Climax	4	31607	31615	31609	31613	m	€ 176.69	€ 202.40	€ 232.76
			5	29908	29912	31128	29914	m	€ 176.69	€ 202.40	€ 232.76
			6	31608	31616	31610	31614	m	€ 176.69	€ 202.40	€ 232.76
			7	29909	29913	31129	29915	m	€ 176.69	€ 202.40	€ 232.76







## FINISHING

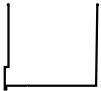

0: mill-finished aluminium or standard

RAL 9010 white / RAL 7016 ST anthracite structure: in stock (delivery time 3 weeks)

Other standard RAL colours: start up costs of € 200 net for each colour (delivery time on request)

\* any other RAL colour: +15% and start up cost of € 200 net for each colour (delivery time on request)

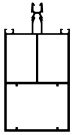
GROUP	TYPE	DESCRIPTION	LENGTH	ARTICLE NUMBER				UN.	PRICE / UNIT		
G	GUTTERS		M	0	9010	7016 ST	RAL		0	STANDARD COLOURS	RAL *
	GDGK	Cover for IPE in GDG	6	31618	31622	31624	31626	m	€ 21.20	€ 27.62	€ 31.76
			7	29922	29928	31131	29926	m	€ 21.20	€ 27.62	€ 31.76
	GDGL	LED profile for GDG	4	31627	31631	31633	31635	m	€ 2.36	€ 6.59	€ 7.58
			5	29930	29936	31132	29934	m	€ 2.36	€ 6.59	€ 7.58
			6	31628	31632	31634	31636	m	€ 2.36	€ 6.59	€ 7.58
			7	29931	29937	31133	29935	m	€ 2.36	€ 6.59	€ 7.58
	SB	Hinge bottom	3.5	21416	21422	31138	21425	m	€ 11.61	€ 13.35	€ 15.35
			5	21417	21423	31139	21426	m	€ 11.61	€ 13.35	€ 15.35
			7	21418	21424	31140	21427	m	€ 11.61	€ 13.35	€ 15.35
	G120A	Gutter 120A	3.5	13283	13294	54976	21160	m	€ 27.48	€ 34.21	€ 39.34
			5	13285	13295	54977	21161	m	€ 27.48	€ 34.21	€ 39.34
			7	13291	13296	54978	21162	m	€ 27.48	€ 34.21	€ 39.34
	GR	Raised profile for gutter	3.5	17820	17828	31343	21163	m	€ 21.22	€ 24.42	€ 28.08
			5	17819	17830	31344	21164	m	€ 21.22	€ 24.42	€ 28.08
			7	17821	17831	31345	21165	m	€ 21.22	€ 24.42	€ 28.08
	VS	Steel tube 80 x 25 x 3 galva for GX	6	51818				m	€ 45.09		
	V1243	Steel tube 120 x 40 x 3 galva for GXLX	6.15	72217				m	€ 53.47		

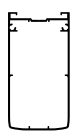
GROUP	TYPE	DESCRIPTION	LENGTH	ARTICLE NUMBER				UN.	PRICE / UNIT		
T	RAFTERS		M	0	9010	7016 ST	RAL		0	STANDARD COLOURS	RAL *
	DX	Rafter Climalux	2.5	34862	34867	34872	34877	m	€ 47.83	€ 56.26	€ 64.70
			3	34863	34868	34873	34878	m	€ 47.83	€ 56.26	€ 64.70
			3.5	34864	34869	34874	34879	m	€ 47.83	€ 56.26	€ 64.70
			4	34865	34870	34875	34880	m	€ 47.83	€ 56.26	€ 64.70
			4.5	109358	109360	109361	109359	m	€ 47.83	€ 56.26	€ 64.70
	DX2	Rafter Climalux type 2	4	108984	108988	108990	108986	m	€ 63.27	€ 74.42	€ 85.57
			4.5	108532	108541	108538	108535	m	€ 63.27	€ 74.42	€ 85.57
			5	108985	108989	108991	108987	m	€ 63.27	€ 74.42	€ 85.57
			5.5	108533	108542	108539	108536	m	€ 63.27	€ 74.42	€ 85.57
			6	108534	108543	108540	108537	m	€ 63.27	€ 74.42	€ 85.57
	D1	Rafter 1	2.5	21246	21261	31145	21256	m	€ 26.08	€ 29.98	€ 34.48
			3	21247	21262	31146	21257	m	€ 26.08	€ 29.98	€ 34.48
			3.5	21248	21263	31147	21258	m	€ 26.08	€ 29.98	€ 34.48
			4	21249	21264	31148	21259	m	€ 26.08	€ 29.98	€ 34.48
			6	21250	21265	31149	21260	m	€ 26.08	€ 29.98	€ 34.48
	D2	Rafter 2	3.5	23467	23476	31150	23473	m	€ 37.97	€ 43.65	€ 50.20
			4	23468	23477	31151	23474	m	€ 37.97	€ 43.65	€ 50.20
			5	24446	24448	31152	24449	m	€ 37.97	€ 43.65	€ 50.20
			6	23469	23478	31153	23475	m	€ 37.97	€ 43.65	€ 50.20





## FINISHING

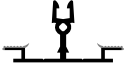

0: mill-finished aluminium or standard

RAL 9010 white / RAL 7016 ST anthracite structure: in stock (delivery time 3 weeks)

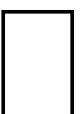
Other standard RAL colours: start up costs of € 200 net for each colour (delivery time on request)

\* any other RAL colour: +15% and start up cost of € 200 net for each colour (delivery time on request)

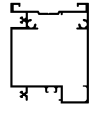
GROUP	TYPE	DESCRIPTION	LENGTH	ARTICLE NUMBER				UN.	PRICE / UNIT		
				0	9010	7016 ST	RAL		0	STANDARD COLOURS	RAL *
<b>T</b>	RAFTERS	D3 Rafter 3	5	41742	41674	41676	41678	m	€ 90.76	€ 95.29	€ 109.58
			5.5	43312	43315	43314	43313	m	€ 90.76	€ 95.29	€ 109.58
	TP	Thermal rafter of PVC	2.7	21277				m	€ 10.48		
			3.2	21278				m	€ 10.48		
			3.7	21279				m	€ 10.48		
			4.2	21280				m	€ 10.48		
			5.2	24468				m	€ 10.48		
			6.2	21281				m	€ 10.48		
	TPG	Thermal rafter of PVC for glass	4.2	25055				m	€ 10.48		
			5.2	25056				m	€ 10.48		
			6.2	25057				m	€ 10.48		
			7.2	25058				m	€ 10.48		
	V642	Steel tube 60 x 40 x 2 galva for D1 and GD1	4	21514				m	€ 16.09		
			5	28964				m	€ 16.09		
			6	21515				m	€ 16.09		
	V853	Steel tube 80 x 50 x 3 galva for DX2	6	108544				m	€ 60.21		

GROUP	TYPE	DESCRIPTION	LENGTH	ARTICLE NUMBER				UN.	PRICE / UNIT		
				0	9010	7016 ST	RAL		0	STANDARD COLOURS	RAL *
<b>L</b>	SIDE RAFTERS	ZD Side rafter	2.5	21282	21298	31154	21293	m	€ 27.20	€ 31.78	€ 36.55
			3	21284	21299	31155	21294	m	€ 27.20	€ 31.78	€ 36.55
	ZD	Side rafter	3.5	21285	21300	31156	21295	m	€ 27.20	€ 31.78	€ 36.55
			4	21286	21301	31157	21296	m	€ 27.20	€ 31.78	€ 36.55
			6	21287	21302	31158	21297	m	€ 27.20	€ 31.78	€ 36.55
			6	24018	24020	31169	24021	m	€ 17.05	€ 19.62	€ 22.56
			ZD2B	Side rafter D2 clip	6	24018	24020	31169	24021	m	€ 17.05
	ZDC	Side cover 16, 25, 32mm	2.8	21304	21332	31164	21337	m	€ 36.80	€ 42.33	€ 48.68
			3.3	21305	21333	31165	21338	m	€ 36.80	€ 42.33	€ 48.68
			3.8	21306	21334	31166	21339	m	€ 36.80	€ 42.33	€ 48.68
			4.3	21307	21335	31167	21340	m	€ 36.80	€ 42.33	€ 48.68
			6.3	21308	21336	31168	21341	m	€ 36.80	€ 42.33	€ 48.68
				L16P	Side profile 16, 25, 32mm	2.5	16718	15478	31347	21231	m
3	16719	15479				31348	21232	m	€ 11.87	€ 13.64	€ 15.69
3.5	16720	15480				31349	21233	m	€ 11.87	€ 13.64	€ 15.69
4	16721	15481				31350	21234	m	€ 11.87	€ 13.64	€ 15.69
5	16722	15482				31351	21235	m	€ 11.87	€ 13.64	€ 15.69
7	16723	15483				31353	21237	m	€ 11.87	€ 13.64	€ 15.69



### FINISHING

0: mill-finished aluminium or standard

RAL 9010 white / RAL 7016 ST anthracite structure: in stock (delivery time 3 weeks)

Other standard RAL colours: start up costs of € 200 net for each colour (delivery time on request)

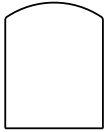
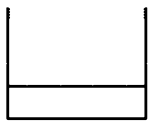
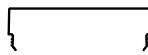
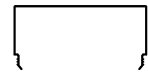
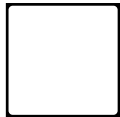
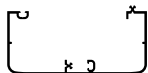
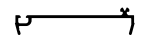
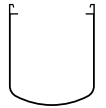
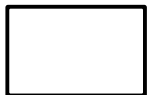
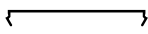
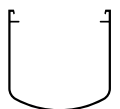
\* any other RAL colour: +15% and start up cost of € 200 net for each colour (delivery time on request)

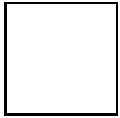
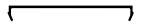
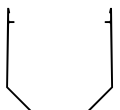
GROUP	TYPE	DESCRIPTION	LENGTH	ARTICLE NUMBER				UN.	PRICE / UNIT		
				0	9010	7016 ST	RAL		0	STANDARD COLOURS	RAL *
	PX	Post Climalux 110/141 for gutter GX	2.5	34882	34884	34886	34888	m	€ 47.01	€ 55.34	€ 63.64
			3.25	34883	34885	34887	34889	m	€ 47.01	€ 55.34	€ 63.64
			5	62710		62712	62711	m	€ 47.01	€ 55.34	€ 63.64
	PXLX	Post part Climalux 150/120 for gutter GX/GXLX	2.5	69700	69703	69702	69701	m	€ 78.20	€ 89.92	€ 103.41
			3.25	69704	69707	69706	69705	m	€ 78.20	€ 89.92	€ 103.41
	PCLX	Post clip 150/30 for PXLX and gutter GX	2.5	69722	69725	69724	69723	m	€ 30.60	€ 35.18	€ 40.46
			3.25	69726	69729	69728	69727	m	€ 30.60	€ 35.18	€ 40.46
	PCLXLX	Post clip 150/60 for PXLX and gutter GXLX	2.5	69711	69714	69713	69712	m	€ 37.22	€ 42.82	€ 49.24
			3.25	69715	69718	69717	69716	m	€ 37.22	€ 42.82	€ 49.24
	PGDX	Post Climalux 110/110 for cross-beam GDX	2.5	35169	35171	35173	35175	m	€ 61.57	€ 68.10	€ 78.32
			3.25	35170	35172	35174	35176	m	€ 61.57	€ 68.10	€ 78.32
			5	41505	41509	41511	41551	m	€ 61.57	€ 68.10	€ 78.32
			6.5	41508	41510	41512	51552	m	€ 61.57	€ 68.10	€ 78.32
	P	Post part 110/50	2.5	21474	21478	31229	21496	m	€ 32.15	€ 36.98	€ 42.53
			3.25	21475	21479	31230	21497	m	€ 32.15	€ 36.98	€ 42.53
	PCB	Post clip base for PC	2.5	21510				m	€ 10.75		
			3.25	21511				m	€ 10.75		
	PC	Post clip for P	2.5	21472	21502	31170	21506	m	€ 47.73	€ 54.91	€ 63.15
			3.25	21473	21503	31171	21507	m	€ 47.73	€ 54.91	€ 63.15
	P72	Post 72/110	2.5	35660	35664	35662	35666	m	€ 54.41	€ 63.24	€ 72.73
			3.25	35661	35665	35663	35667	m	€ 54.41	€ 63.24	€ 72.73
			5	54993	58499	58497	58495	m	€ 54.41	€ 63.24	€ 72.73
			6.5	54994	58500	58498	58496	m	€ 54.41	€ 63.24	€ 72.73
	PCB72	Clip for side cover PC72	2.5	45376				m	€ 12.98		
			3.25	45377				m	€ 12.98		
	PC72	Water drainage cover for P72	2.5	35668	35673	35671	35675	m	€ 42.12	€ 53.96	€ 62.05
			3.25	35669	35674	35672	35676	m	€ 42.12	€ 53.96	€ 62.05
			5	58501	58507	58505	58503	m	€ 42.12	€ 53.96	€ 62.05
			6.5	58502	58508	58506	58504	m	€ 42.12	€ 53.96	€ 62.05
	98	Post 50/100	2.5	10476	10478	31199	16059	m	€ 27.83	€ 31.97	€ 36.77
			3.25	10477	10479	31200	16060	m	€ 27.83	€ 31.97	€ 36.77
			5	8658	8387	31201	16061	m	€ 27.83	€ 31.97	€ 36.77
			6.5	11920	14047	31202	16062	m	€ 27.83	€ 31.97	€ 36.77
	100	Post 100/100	2.5	11907	11913	31197	15978	m	€ 37.27	€ 45.20	€ 51.98
			3.25	11908	11914	31198	15980	m	€ 37.27	€ 45.20	€ 51.98
	97A	Clip for side cover 97B	2.5	10482				m	€ 12.98		
			3.25	10483				m	€ 12.98		
	97B	Clip for side cover	2.5	10484	10486	31203	16056	m	€ 30.43	€ 34.98	€ 40.23
			3.25	10485	10488	31204	16057	m	€ 30.43	€ 34.98	€ 40.23

## FINISHING





0: mill-finished aluminium or standard

RAL 9010 white / RAL 7016 ST anthracite structure: in stock (delivery time 3 weeks)



Other standard RAL colours: start up costs of € 200 net for each colour (delivery time on request)





\* any other RAL colour: +15% and start up cost of € 200 net for each colour (delivery time on request)

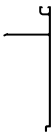

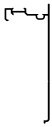
GROUP	TYPE	DESCRIPTION	LENGTH	ARTICLE NUMBER			UN.	PRICE / UNIT			
Y	RISING PROFILES		M	0	9010	7016 ST	RAL	0	STANDARD COLOURS	RAL *	
	Y10	Adapter profile 8mm for 10mm sheet	6.5	18324	18403	31163	21283	m	€ 3.14	€ 5.69	€ 6.54
			7	13314				m	€ 4.93		
	Y32	Adapter profile 15mm for 32mm sheet	7	13314				m	€ 4.93		
	Y16A	Raising profile alu 16mm	3.5	21520	21524	31181	21526	m	€ 6.52	€ 7.49	€ 8.61
			7	21518	21525	31182	21527	m	€ 6.52	€ 7.49	€ 8.61
	Y16P	Thermal break ABS 16mm	1	21528				m	€ 4.54		
			4	21529				m	€ 4.54		



## 2. Finishing profiles



GROUP	TYPE	DESCRIPTION	LENGTH	ARTICLE NUMBER			UN.	PRICE / UNIT			
A	SHEET SPACERS		M	0	9010	7016 ST	RAL	0	STANDARD COLOURS	RAL *	
	AX	Sheet spacer Climalux AX	0.942	34890	34894	34898	34902	pc	€ 21.03	€ 24.72	€ 28.43
			1.012	34891	34895	34899	34903	pc	€ 22.65	€ 26.65	€ 30.65
			1.162	34892	34896	34900	34904	pc	€ 25.94	€ 30.51	€ 35.09
			1.192	60343	60344	60345	60392	pc	€ 26.58	€ 31.27	€ 35.96
			2.5	61311	61313	61312	61314	pc	€ 55.80	€ 65.60	€ 75.44
	A1	Sheet spacer A1	0.942	21428	21445	31174	21451	pc	€ 15.10	€ 17.38	€ 19.99
			1.012	21429	21446	31175	21452	pc	€ 16.10	€ 18.54	€ 21.32
			1.162	21430	21447	31176	21453	pc	€ 18.21	€ 20.97	€ 24.12
			1.192	21431	21448	31177	21454	pc	€ 18.48	€ 21.25	€ 24.44
			2.5	61303	61305	61304	61306	pc	€ 32.88	€ 37.80	€ 43.47
	A2	Sheet spacer A2	0.942	31404	31412	31416	31420	pc	€ 18.10	€ 22.53	€ 25.91
			1.012	31405	31413	31417	31421	pc	€ 19.49	€ 24.21	€ 27.84
			1.162	31406	31414	31418	31422	pc	€ 22.31	€ 27.79	€ 31.96
			1.192	31407	31415	31419	31423	pc	€ 22.90	€ 28.50	€ 32.78
			2.5	61307	61309	61308	61310	pc	€ 48.02	€ 59.78	€ 68.75

GROUP	TYPE	DESCRIPTION	LENGTH	ARTICLE NUMBER			UN.	PRICE / UNIT			
CC	CLIMACROWN		M	0	9010	7016 ST	RAL	0	STANDARD COLOURS	RAL *	
	CC150	Stack profile 150mm	5	48048	48051	48050	48049	m	€ 28.29	€ 36.28	€ 41.72
			7	48052	48055	48054	48053	m	€ 28.29	€ 36.28	€ 41.72
	CC225	Stack profile 225mm	5	48062	48065	48064	48063	m	€ 50.97	€ 61.98	€ 71.28
			7	48066	48069	48068	48067	m	€ 50.97	€ 61.98	€ 71.28
	CCL	Corner profile Climacrown	1.53	48071	48073	48074	48072	m	€ 22.62	€ 29.04	€ 33.40
	CCU	Edge profile Climacrown	5	44887	44891	44893	44889	m	€ 5.54	€ 8.37	€ 9.63
			7	44888	44892	44894	44890	m	€ 5.54	€ 8.37	€ 9.63

**FINISHING** | O: mill-finished aluminium or standard  
 RAL 9010 white / RAL 7016 ST anthracite structure: in stock (delivery time 3 weeks)  
 Other standard RAL colours: start up costs of € 200 net for each colour (delivery time on request)  
 \* any other RAL colour: +15% and start up cost of € 200 net for each colour (delivery time on request)

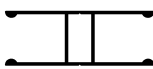

# SELF-SUPPORTING SYSTEMS

GROUP	TYPE	DESCRIPTION	LENGTH	ARTICLE NUMBER				UN.	PRICE / UNIT		
TR	PROFILES FOR TRIANGLE		M	0	9010	7016 ST	RAL		0	STANDARD COLOURS	RAL *
		TRB Base profile for triangle 25mm for glass 10mm	5.2	47739	47742	47741	47740	m	€ 8.62	€ 12.32	€ 14.17
		TRC Clips profile for triangle	5.2	47735	47738	47737	47736	m	€ 4.02	€ 5.98	€ 6.88

GROUP	TYPE	DESCRIPTION	LENGTH	ARTICLE NUMBER				UN.	PRICE / UNIT		
W	PROFILES FOR TRIANGLE AND SIDE WALLS		M	0	9010	7016 ST	RAL		0	STANDARD COLOURS	RAL *
		WB Base profile for triangle and side wall 42mm for glass 10mm or PC 16mm	5 7	65849 65853	65852 65856	65851 65855	65850 65854	m m	€ 13.18	€ 15.55	€ 17.88
		WC Clips profile for WB	5 7	65857 65861	65860 65864	65859 65863	65858 65862	m m	€ 4.81	€ 5.98	€ 6.88
		WU Side profile U for triangle or side wall	1.5 3	65865 65869	65868 65872	65867 65871	65866 65870	m m	€ 6.52	€ 8.14	€ 9.36
		H Profile H for triangle or side wall	1.5 3 4 7	71943 46426 46427 46428	71945 71948	71946 71949	71944 71947	m m m m	€ 12.77	€ 14.69	€ 16.89



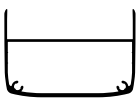
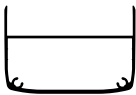
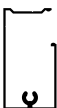

GROUP	TYPE	DESCRIPTION	LENGTH	ARTICLE NUMBER				UN.	PRICE / UNIT		
-	FINISHING STRIP		M	0	9010	7016 ST	RAL		0	STANDARD COLOURS	RAL *
		PLAT Finishing strip 40 x 2mm	3 6	103544 81026	103547 81028	103546 81027	103545 81519	m m	€ 3.89	€ 6.13	€ 7.05

GROUP	TYPE	DESCRIPTION	LENGTH	ARTICLE NUMBER				UN.	PRICE / UNIT		
L	FINISHING PROFILES FOR SCREENS		M	0	9010	7016 ST	RAL		0	STANDARD COLOURS	RAL *
		L1342 L-adapter profile for screen Always use with profile L432	4 5 6	71725 71729 71733	71728 71732	71727 71731	71726 71730 71734	m m m	€ 15.65	€ 18.00	€ 20.70

GROUP	TYPE	DESCRIPTION	LENGTH	ARTICLE NUMBER				UN.	PRICE / UNIT		
LED	PROFILES FOR LED SPOTS		M	0	9010	7016 ST	RAL		0	STANDARD COLOURS	RAL *
		LEDU Profiles for LED spots pre-drilled 3 x	4.2-0.75 4.2-1.00 5.25-1.30 5.97-1.50	45922 45923 45924 45925	45926 45927	45930 45931	39515 39516 39524 45921	m m m m	€ 17.61	€ 22.43	€ 25.79
		LED Profiles for LED spots not pre-drilled	4.2 5.25 5.97	39503 39504 39514	39544 39545	39532 39533	51579 51580 51581	m m m	€ 17.61	€ 22.43	€ 25.79
		KG Base profile cable tray for LED spots	5 7	81798 81802	81801 81805	81800 81804	81799 81803	m m	€ 15.95	€ 18.33	€ 21.08
		KGC Clip profile for cable tray	5 7	81806 81810	81809 81813	81808 81812	81807 81811	m m	€ 3.14	€ 5.61	€ 6.45

FINISHING | 0: mill-finished aluminium or standard  
RAL 9010 white / RAL 7016 ST anthracite structure: in stock (delivery time 3 weeks)  
Other standard RAL colours: start up costs of € 200 net for each colour (delivery time on request)  
\* any other RAL colour: +15% and start up cost of € 200 net for each colour (delivery time on request)

### 3. Rubbers\*\* and clip profiles

GROUP	TYPE	DESCRIPTION	LENGTH	ARTICLE NUMBER			UN.	PRICE / UNIT		
				WHITE	GREY	BLACK		WHITE	GREY	BLACK
               	<b>RUBBERS</b>	<b>M</b>	<b>WHITE</b>	<b>GREY</b>	<b>BLACK</b>		<b>WHITE</b>	<b>GREY</b>	<b>BLACK</b>	
	C1CX	Coextrubber for wall top white/black	35	17701			m	€ 4.75		
		Coextrubber for wall top grey/black	35		17703		m		€ 4.75	
	C12	Support thread for C1CX	200		23875		m		€ 0.78	
	C2CX	Coextrubber white/black for TP - TPG - TPGL	2 x 24	18316	18315		m	€ 6.19	€ 6.19	
		Coextrubber grey/black for TP - TPG - TPGL	35	15471	17697		m	€ 6.19	€ 6.19	
			50	15472	17698		m	€ 6.19	€ 6.19	
	C3	Rubber for sheet spacer AX grey	100		13319		m		€ 1.11	
	C4CX	Coextrubber for MX32 white/black	35	17700			m	€ 5.70		
		Coextrubber for MX32 grey/black	35		15475		m		€ 5.70	
	C5	Rubber for sheet spacer A1-A2 grey	100		8417		m		€ 2.85	
	C7	Rubber black for WB -10mm	100			65895	m			€ 2.79
	C8	Rubber grey for CL16, CL32 and CLSB	300		13328		m		€ 1.48	
	C8	Rubber black for TRB & WB 16mm	300			23803	m			€ 1.48
	CY10	Rubber grey for CL16, CL32 and CLSB	50		29509		m		€ 4.20	
	C11CX	Coextrubber gutter/ridge white/black	50	21557			m	€ 9.46		
	C14	Clip rubber for TRC glass 10mm	50			25858	m			€ 2.58
	C17	Rubber black for WC -10mm	50			72045	m			€ 2.87
C18	Rubber black for WC -16mm	50			72044	m			€ 2.45	
C27	Rubber black for WU / WH -10mm	50			72135	m			€ 1.86	
C31	Support rubber for glass	200		28805		m		€ 4.87		

\*\* Roll length. The rubber sealings are also available in multiple profile lengths.



**FINISHING**



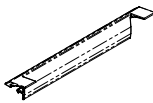

0: mill-finished aluminium or standard

RAL 9010 white / RAL 7016 ST anthracite structure: in stock (delivery time 3 weeks)

Other standard RAL colours: start up costs of € 200 net for each colour (delivery time on request)

\* any other RAL colour: +15% and start up cost of € 200 net for each colour (delivery time on request)

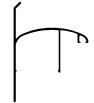
GROUP	TYPE	DESCRIPTION	LENGTH	ARTICLE NUMBER			UN.	PRICE / UNIT		
C	RUBBERS		M	WHITE	GREY	BLACK		WHITE	GREY	BLACK
	H	Seal H-profile outside	pc			82565	pc			€ 4.17
	C18-60	Seal C18 60mm H-profile inside	pc			94659	pc			€ 0.31

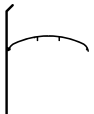
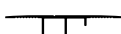
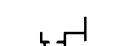
GROUP	TYPE	DESCRIPTION	LENGTH	ARTICLE NUMBER				UN.	PRICE / UNIT		
CL	CLIP PROFILES		M	0	9010	7016 ST	RAL		0	STANDARD COLOURS	RAL *
	CL16	Clip alu 16mm	2	13329	13336	31234	16063	m	€ 11.71	€ 13.47	€ 15.49
			2.5	13330	13337	31235	16064	m	€ 11.71	€ 13.47	€ 15.49
			3	13331	13338	31236	16065	m	€ 11.71	€ 13.47	€ 15.49
			3.5	13332	13339	31237	16066	m	€ 11.71	€ 13.47	€ 15.49
			4	13333	13340	31238	16067	m	€ 11.71	€ 13.47	€ 15.49
			5	13824	13928	31239	16070	m	€ 11.71	€ 13.47	€ 15.49
			6	13334	13341	31240	16071	m	€ 11.71	€ 13.47	€ 15.49
	CL32	Clip alu 25/32mm	2	13350	13352	31242	16073	m	€ 14.89	€ 17.12	€ 19.69
			2.5	13351	13353	31243	16074	m	€ 14.89	€ 17.12	€ 19.69
			3	13154	13159	31244	16075	m	€ 14.89	€ 17.12	€ 19.69
			3.5	13155	13160	31245	16076	m	€ 14.89	€ 17.12	€ 19.69
			4	13156	13161	31246	16088	m	€ 14.89	€ 17.12	€ 19.69
			5	14372	14373	31247	16089	m	€ 14.89	€ 17.12	€ 19.69
			6	13157	13162	31248	16091	m	€ 14.89	€ 17.12	€ 19.69
	CLLX	Side clip Climalux 16mm	3	35705	35710	35715	35720	m	€ 19.14	€ 21.92	€ 25.21
			3.5	35706	35711	35716	35721	m	€ 19.14	€ 21.92	€ 25.21
			4	35707	35712	35717	35722	m	€ 19.14	€ 21.92	€ 25.21
			5	35708	35713	35718	35723	m	€ 19.14	€ 21.92	€ 25.21
			6	109183	109185	109186	109184	m	€ 19.14	€ 21.92	€ 25.21
	CLL	Side clip 16, 25, 32mm	2	17713	17740	31354	21174	m	€ 20.72	€ 23.82	€ 27.39
			2.5	17714	17741	31355	21175	m	€ 20.72	€ 23.82	€ 27.39
			3	17715	17742	31356	21176	m	€ 20.72	€ 23.82	€ 27.39
			3.5	17716	17743	31357	21177	m	€ 20.72	€ 23.82	€ 27.39
			4	17717	17744	31358	21178	m	€ 20.72	€ 23.82	€ 27.39
			5	17718	17745	31359	21179	m	€ 20.72	€ 23.82	€ 27.39
			6	17712	17728	31360	21180	m	€ 20.72	€ 23.82	€ 27.39
	CLSB	Base screwable clip from 8 til 34mm	4	23914				m	€ 8.34		
			5	23915				m	€ 8.34		
			6	23916				m	€ 8.34		
			7	23917				m	€ 8.34		
	CLST	Top screwable clip	4	23922	23938	31251	23946	m	€ 5.95	€ 6.82	€ 7.84
			5	23923	23939	31252	23947	m	€ 5.95	€ 6.82	€ 7.84
			6	23924	23940	31253	23948	m	€ 5.95	€ 6.82	€ 7.84
			7	23925	23941	31254	23949	m	€ 5.95	€ 6.82	€ 7.84
	CLSL	Top screwable sideclip	4	25012	25024	31286	25028	m	€ 18.84	€ 21.66	€ 24.91
			5	25013	25025	31287	25029	m	€ 18.84	€ 21.66	€ 24.91
			6	25014	25026	31288	25030	m	€ 18.84	€ 21.66	€ 24.91
			7	25015	25027	31289	25031	m	€ 18.84	€ 21.66	€ 24.91
	GVT	Top profile for glass connector	2	61297	61300	61298	61301	m	€ 6.11	€ 8.95	€ 10.29
	GVB	Bottom profile for glass connector	2	61293	61296	61294	61302	m	€ 6.73	€ 10.45	€ 12.02











#### FINISHING

0: mill-finished aluminium or standard

RAL 9010 white / RAL 7016 ST anthracite structure: in stock (delivery time 3 weeks)

Other standard RAL colours: start up costs of € 200 net for each colour (delivery time on request)

\* any other RAL colour: +15% and start up cost of € 200 net for each colour (delivery time on request)

GROUP	TYPE	DESCRIPTION	LENGTH	ARTICLE NUMBER			UN.	PRICE / UNIT			
U - L	END PIECES FOR GLAZING		M	O	9010	7016 ST	RAL	O	STANDARD COLOURS	RAL *	
	U16P	Reinforced PVC end piece 16mm white	0.98		13383			pc	€ 4.82		
			1.053		13384			pc	€ 5.20		
			1.2		13385			pc	€ 5.90		
			1.25		13386			pc	€ 6.19		
			6.4		13396			pc	€ 31.56		
	U25P	Reinforced PVC end piece 25mm white	1.2		13397			pc	€ 7.39		
			2.1		35375			pc	€ 12.95		
			5		13441			pc	€ 30.82		
	U32P	Reinforced PVC end piece 32mm white	0.98		17874			pc	€ 6.90		
			1.053		27249			pc	€ 7.44		
			1.23		13400			pc	€ 8.48		
			1.25		13401			pc	€ 8.64		
			5		13440			pc	€ 34.48		
	U16A	Alu end piece 16mm	0.98	13406				pc	€ 5.39		
			1.053	13407				pc	€ 5.84		
			1.2	13408				pc	€ 6.62		
			6.5	18321				pc	€ 35.83		
	U32A	Alu end piece 32mm	1.23	13469			15917	pc	€ 9.68	€ 15.33	
	U16	Pre-drilled alu end piece 16mm	0.98	23553	23569	31183	23565	pc	€ 9.75	€ 12.94	€ 14.88
			1.053	23554	23570	31184	23566	pc	€ 10.45	€ 12.94	€ 14.88
			1.2	23555	23571	31185	23567	pc	€ 11.92	€ 15.45	€ 17.77
			6.1	23556	23572	31186	23568	pc	€ 65.22	€ 85.72	€ 98.58
	U32	Pre-drilled alu end piece 32mm	0.98	27239	27245	31396	27243	pc	€ 12.35	€ 15.93	€ 18.32
			1.23	21534	21552	31195	21555	pc	€ 15.12	€ 19.49	€ 22.41
			5	21535	21553	31196	21556	pc	€ 61.48	€ 79.24	€ 91.13
	U55	Pre-drilled alu end piece 55mm	1.23	69742	69744	69743		pc	€ 18.28	€ 23.38	
	L432	L obturator profile L for finish side rafter L for finish vertical screen	6	23529	23552	31160	23551	m	€ 8.26	€ 9.50	€ 10.93
	L632	L obturator profile	7	27224	27227	31161	27228	m	€ 11.95	€ 15.23	€ 17.51
	TOCHT10	Water block profile PVC for glass 8-10mm black length 2500mm	pc	106062				pc	€ 35.77		

### FINISHING

O: mill-finished aluminium or standard

RAL 9010 white / RAL 7016 ST anthracite structure: in stock (delivery time 3 weeks)

Other standard RAL colours: start up costs of € 200 net for each colour (delivery time on request)

\* any other RAL colour: +15% and start up cost of € 200 net for each colour (delivery time on request)

## 4. Accessories

GROUP	TYPE	DESCRIPTION	QUANT.	ARTICLE NUMBER				UN.	PRICE / UNIT			
				0	9010	7016 ST	RAL		0	STANDARD COLOURS	RAL *	
<b>S</b>	<b>END PIECES AND STOP PROFILES</b>											
		GASX	End piece gutter Climalux for GX	pc	34948	34949	34950	34951	pc	€ 6.37	€ 15.76	€ 18.12
		GLSX	End piece gutter Climalux for GX + GLX	pc	34952	34953	34954	34955	pc	€ 7.01	€ 16.96	€ 19.50
		GRSX	End piece gutter for GX + GR	pc	34956	34957	34958	34959	pc	€ 6.52	€ 20.05	€ 23.06
		GASXL	End piece gutter Climalux for GXLX standard	pc	71888	71891	71890	71889	pc	€ 26.04	€ 29.94	€ 34.43
		GASXL	End piece gutter Climalux for GXLX left with Skylux logo (left: seen from the inside)	pc	71892	71895	71894	71893	pc	€ 26.04	€ 29.94	€ 34.43
		GASXL	End piece gutter Climalux for GXLX right with Skylux logo (right: seen from the inside)	pc	71896	71899	71898	71897	pc	€ 26.04	€ 29.94	€ 34.43
		GDSX	End piece Climalux for cross-beam GDX	pc	35149	35150	35151	35152	pc	€ 6.46	€ 15.63	€ 17.97
		GAS1	End piece gutter for G + GD	pc	21543	21540	31259	21544	pc	€ 13.97	€ 16.06	€ 18.47
		GAS2	End piece gutter for GD	pc	21579	21581	31260	21582	pc	€ 12.17	€ 17.73	€ 20.39
		GAS3	End piece gutter for GD2 + G	pc	23737	23739	31271	27363	pc	€ 36.75	€ 52.86	€ 60.79
		GAS4	End piece gutter for GDG	pc	29939	29942	31269	29941	pc	€ 31.52	€ 38.68	€ 44.48
		G120AS	End piece gutter for G120A	pc	21310	13306	47198	21588	pc	€ 3.94	€ 9.07	€ 10.43
		GDCA	End piece for GDC	pc	27359	27362	31274	27361	pc	€ 14.47	€ 22.57	€ 25.96













### FINISHING

0: mill-finished aluminium or standard

RAL 9010 white / RAL 7016 ST anthracite structure: in stock (delivery time 3 weeks)

Other standard RAL colours: start up costs of € 200 net for each colour (delivery time on request)

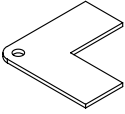
\* any other RAL colour: +15% and start up cost of € 200 net for each colour (delivery time on request)







GROUP	TYPE	DESCRIPTION	QUANT.	ARTICLE NUMBER				UN.	PRICE / UNIT		
S	END PIECES AND STOP PROFILES			0	9010	7016 ST	RAL		0	STANDARD COLOURS	RAL *
		GRS1	End piece for GR on G120A	pc	17832	17835		21598	pc	€ 9.61	€ 11.02
	GRS2	End piece gutter for G + GD + GR	pc	21584	21586	31261	21587	pc	€ 28.03	€ 36.53	€ 42.01
	GRS3	End piece gutter for GD2 + G + GR	pc	27364	27367	31272	27366	pc	€ 47.04	€ 65.72	€ 75.58
	GAP1	Thermal end piece for GD1	pc	22379				pc	€ 11.21		
	GAP2	Thermal end piece for GD2	pc	27337				pc	€ 21.84		
	MASX	End piece wall profile Climalux for MX	pc	34968	34969	34970	34971	pc	€ 4.73	€ 10.56	€ 12.14
	MASX32	End piece wall profile Climalux for MX32	pc	60394	60396	60397	60395	pc	€ 5.42	€ 12.12	€ 13.94
	MAS	End piece wall profile Climax for MT + MB	pc	21589	21591	31275	21592	pc	€ 12.95	€ 14.89	€ 17.12
	NASZ	End piece ridge saddle roof	pc	23876	23878	31276	23879	pc	€ 24.71	€ 28.43	€ 32.69
	ZDCS	End piece for side cover	pc	21217	21569	31258	21570	pc	€ 4.57	€ 6.12	€ 7.04
	CCLAS	End piece for corner profile CCL	pc	48081	48083	48084	48082	pc	€ 6.29	€ 9.87	€ 11.35
	S16X	Stop Climalux for DX	pc	34960	34961	34962	34963	pc	€ 6.49	€ 9.84	€ 11.32

**FINISHING**

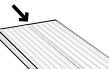
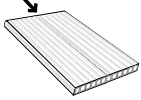
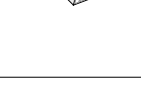
0: mill-finished aluminium or standard  
 RAL 9010 white / RAL 7016 ST anthracite structure: in stock (delivery time 3 weeks)  
 Other standard RAL colours: start up costs of € 200 net for each colour (delivery time on request)  
 \* any other RAL colour: +15% and start up cost of € 200 net for each colour (delivery time on request)

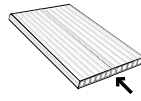
# SELF-SUPPORTING SYSTEMS

GROUP	TYPE	DESCRIPTION	QUANT.	ARTICLE NUMBER				UN.	PRICE / UNIT		
S	END PIECES AND STOP PROFILES			0	9010	7016 ST	RAL		0	STANDARD COLOURS	RAL *
		S16.3	Stop 16/3 for TP - TPG	pc	21218	21562	31255	21563	pc	€ 3.19	€ 5.19
	S32.3	Stop 32/3 for TP - TPG	pc	21220	21566	31256	21567	pc	€ 3.34	€ 5.54	€ 6.37
	S38.3	Stop 38/3 for TP - TPG with glass	pc	25079	25082	31257	25083	pc	€ 5.08	€ 5.83	€ 6.70
	LEDESX	End piece for LED profile Climalux	pc	61249	61251	61252	61250	pc	€ 13.52	€ 16.08	€ 18.49
	LEDES	End piece for LED profile Climax	pc	39654	39689	39688	39666	pc	€ 13.52	€ 16.08	€ 18.49
	KGAS	End piece for cable tray	pc	81814	81816	81817	81815	pc	€ 8.53	€ 11.79	€ 13.56

GROUP	TYPE	DESCRIPTION	LENGTH	ARTICLE NUMBER				UN.	PRICE / UNIT		
B	TAPES		M	0	9010	7016 ST	RAL		0	STANDARD COLOURS	RAL *
		BT16	Closed synthetic tape for 10 and 16mm sheets With guarantee	10	14408				pc	€ 10.78	
50				14409				pc	€ 31.13		
	BT25	Closed synthetic tape for 25mm sheets With guarantee	10	14411				pc	€ 12.28		
			50	14412				pc	€ 36.16		
	BT32	Closed synthetic tape for 32mm sheets With guarantee	10	14413				pc	€ 14.79		
			33	82955				pc	€ 27.50		
	BT55	Closed synthetic tape for 55mm sheets With guarantee	33	82956				pc	€ 59.29		
			50	60354				pc	€ 97.41		
	BB16	Perforated synthetic tape for 16mm sheets With guarantee	10	13372				pc	€ 20.10		
			33	13373				pc	€ 48.20		
	BB25	Perforated synthetic tape for 25mm sheets With guarantee	10	14416				pc	€ 26.63		
			33	14424				pc	€ 62.79		
	BB32	Perforated synthetic tape for 32mm sheets With guarantee	10	13374				pc	€ 34.64		
			33	13376				pc	€ 82.83		
	BB55	Perforated synthetic tape for 55mm sheets With guarantee	33	60353				pc	€ 143.54		
	BANDV	One-sided adhesive tape 12 x 3-7mm for triangle profile	8	73799				pc	€ 33.03		
	BANDM1	Self adhesive sealing EPDM 6 x 15mm	10	94665				pc	€ 24.02		

## FINISHING



0: mill-finished aluminium or standard











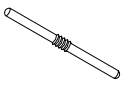

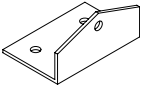
RAL 9010 white / RAL 7016 ST anthracite structure: in stock (delivery time 3 weeks)

Other standard RAL colours: start up costs of € 200 net for each colour (delivery time on request)

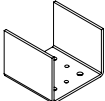
\* any other RAL colour: +15% and start up cost of € 200 net for each colour (delivery time on request)



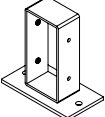

GROUP	TYPE	DESCRIPTION	LENGTH	ARTICLE NUMBER			UN.	PRICE / UNIT		
B	TAPES		M	0	9010	7016 ST	RAL	0	STANDARD COLOURS	RAL *
	BANDM1	Self adhesive sealing PVC tape 15 x 15mm	m	30517				m	€ 2.80	
	BANDM1	Self adhesive sealing PVC tape 20 x 30mm	5	94664				pc	€ 57.86	

GROUP	TYPE	DESCRIPTION	QUANT.	ARTICLE NUMBER				UN.	PRICE / UNIT		
MT	MOUNTING ACCESSORIES			0	9010	7016 ST	RAL		0	STANDARD COLOURS	RAL *
	909	Connecting pins	pc	8434				pc	€ 0.99		
	GDC	Gutter rafter support bracket for GD1, GD2 and GL	pc	21193	21594	31280	21595	pc	€ 33.42	€ 42.50	€ 48.88
	LGDX	Fixing profile "L" for cross-beam GDX	pc	35145	35146	35147	35148	pc	€ 3.29	€ 8.59	€ 9.88
	NCZ	Ridge support bracket saddle roof	pc	23880				pc	€ 62.67		
	PV	Base-plate for post 110/50	pc	21599	21601	31282	21602	pc	€ 58.15	€ 73.17	€ 84.15
	PU	U top-bottom for post P	pc	21603				pc	€ 6.20		
	PUX	U top-bottom for post PGDX 110/110	pc	35143				pc	€ 10.01		
	PU72	U top-bottom for post P72	pc	35831				pc	€ 9.39		
	PT72	Top-plate for post P72	pc	35832				pc	€ 5.63		
	PT110	Top-plate for post PGDX	pc	51817				pc	€ 8.14		
	UT10	U top-bottom for post 100	pc	13582				pc	€ 21.29		
	UT98	U top-bottom for post 98	pc	13580				pc	€ 15.80		
	GPV	Base-plate statik for post P72	pc	35410				pc	€ 91.39		

**FINISHING**

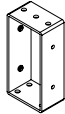
0: mill-finished aluminium or standard  
 RAL 9010 white / RAL 7016 ST anthracite structure: in stock (delivery time 3 weeks)  
 Other standard RAL colours: start up costs of € 200 net for each colour (delivery time on request)  
 \* any other RAL colour: +15% and start up cost of € 200 net for each colour (delivery time on request)

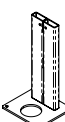
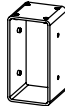
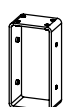
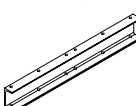
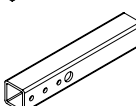
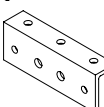
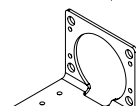
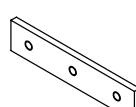
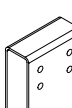
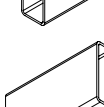
GROUP	TYPE	DESCRIPTION	QUANT.	ARTICLE NUMBER				UN.	PRICE / UNIT		
MT	MOUNTING ACCESSORIES			0	9010	7016 ST	RAL		0	STANDARD COLOURS	RAL *
	GPT	Top part statik for post P72	pc	35409				pc	€ 43.79		
	PS	Post support 100 x 100 for PGDX	pc	47792				pc	€ 157.13		
	PS01	Post support 60 x 100 for P72	pc	94528				pc	€ 159.53		
	PS02	Post support 30 x 140 for PXLX	pc	94527				pc	€ 226.06		
	C110	Connector statik for post PGDX - GDX	pc	48111				pc	€ 78.20		
	C72	Connector statik for post P72 - GDX	pc	48113				pc	€ 73.40		
	UPN140	Connecting profile statik for GDG	pc	51816				pc	€ 210.83		
	KO	Tube statik for GDG	pc	35411				pc	€ 34.59		
	LT150	"L" connecting piece for post PXLX - gutter GX/GXLX	pc	69698				pc	€ 23.06		
	LB150	"L" Bracket bottom for post PXLX	pc	69699				pc	€ 19.24		
	PT150	Top-plate for gutter GXLX	pc	69697				pc	€ 9.09		
	VGXLX	Connecting piece for gutter GXLX	pc	78180				pc	€ 46.13		
	VS	Connecting piece for gutter GX - LT150	pc	93874				pc	€ 26.94		







## FINISHING

0: mill-finished aluminium or standard

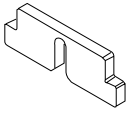
RAL 9010 white / RAL 7016 ST anthracite structure: in stock (delivery time 3 weeks)

Other standard RAL colours: start up costs of € 200 net for each colour (delivery time on request)

\* any other RAL colour: +15% and start up cost of € 200 net for each colour (delivery time on request)

GROUP	TYPE	DESCRIPTION	QUANT.	ARTICLE NUMBER				UN.	PRICE / UNIT		
MT	MOUNTING ACCESSORIES			0	9010	7016 ST	RAL		0	STANDARD COLOURS	RAL *
	KGBP	Mounting plate for cable tray	pc	82564				pc	€ 4.38		
	BMR	Stainless screw, nut and ring spring M8	pc	21607				pc	€ 1.16		
	BGDG	Stainless screw M10 x 30 for posts P72	pc	35412				pc	€ 0.90		
	BOUT	Stainless screw M10 x 120 for PGDX	pc	82574				pc	€ 3.20		
	BOUT	Stainless screw M10 x 180 for GDG	pc	51810				pc	€ 10.34		
	MOER	Stainless prevailing nut M10	pc	17996				pc	€ 0.74		
	RING	Stainless washer M10	pc	46673				pc	€ 0.12		
	BOUT	Stainless screw M8 x 16 for LT150 - GXLX	pc	72910				pc	€ 0.44		
	BOUT	Screw M10 x 20 for LT150 - PXLX	pc	49641				pc	€ 0.70		
	BOUT	Screw M10 x 30	pc	51701				pc	€ 0.70		
	BOUT	Screw M10 x 60 for C72 - PXLX	pc	82573				pc	€ 2.59		
	BOUT	Screw M10 x 100 for C72 - P72	pc	82572				pc	€ 1.69		
	RING	Stainless lock washer M8 for LT150 - GXLX	pc	72912				pc	€ 0.13		
	RING	Stainless lock washer M10 for PXLX	pc	72911				pc	€ 0.15		
	K	Connector for rafter D1/D2	0.04m	21558				pc	€ 6.70		
			1m	21559				pc	€ 30.01		
	KD3	Connector for rafter D3	0.04m	43185				pc	€ 9.48		
	411	Outlet 3m + socket Ø 80mm	3m		10523	43729		m		€ 15.45	
	413	Elbow 67° with socket Ø 80mm	pc		10528	43732		pc		€ 9.98	
	414	Elbow 87° with socket Ø 80mm	pc		10530	43733		pc		€ 9.98	
	GVL	Concentric adapter Ø 80/75 grey	pc	80814				pc	€ 3.56		
	412	Bracket for outlet	pc		10526	43730		pc		€ 4.33	
	412S	Screw for bracket	pc	10532				pc	€ 0.54		
	GC	Water outlet + swivel Ø 80mm grey	pc	13308				pc	€ 12.55		
	GATZ	Core drill Ø 80mm	pc	41354				pc	€ 31.86		
	BOOR	Conical countersink Ø 16.5mm	pc	51197				pc	€ 46.10		
	BOOR	Conical countersink Ø 20.5mm	pc	51819				pc	€ 50.42		
	BUGS	Universal outlet	pc	22387	22389	31384	22391	pc	€ 14.10	€ 22.37	€ 25.73
	WUGS	Outlet gutter spout	pc	22392				pc	€ 14.76		
	GB	Sealing tape gutter connector	pc	13309				pc	€ 7.97		
	LOGO	Logo Climalux for end piece gutter	pc	35791				pc	€ 4.34		
	LOGO	Logo Climax for end piece gutter	pc	29943				pc	€ 4.34		
	KAL 8	PVC buffer 8mm for single glazing	pc	27578				pc	€ 0.28		

## FINISHING

0: mill-finished aluminium or standard

RAL 9010 white / RAL 7016 ST anthracite structure: in stock (delivery time 3 weeks)

Other standard RAL colours: start up costs of € 200 net for each colour (delivery time on request)

\* any other RAL colour: +15% and start up cost of € 200 net for each colour (delivery time on request)

# SELF-SUPPORTING SYSTEMS

GROUP	TYPE	DESCRIPTION	QUANT.	ARTICLE NUMBER				UN.	PRICE / UNIT		
MT	MOUNTING ACCESSORIES			0	9010	7016 ST	RAL		0	STANDARD COLOURS	RAL *
	KAL 20	Pvc buffer 20mm for double glazing	pc	27331				pc	€ 0.45		
	KAL 22	PVC buffer 22mm for glazing in TRB profile	pc	47663				pc	€ 0.23		
	KAL 28	PP buffer 28mm for glazing in WB profile	pc	69951				pc	€ 0.62		
	HILO25	Galvanised screw for PVC 5.2 x 25mm for CLSB (set of 25 pcs)	25 pcs	24202				set (25)	€ 6.00		
	HILO40	Galvanised screw for PVC 5.2 x 40mm for CLSB (set of 25 pcs)	25 pcs	24201				set (25)	€ 6.00		
	HILO45	Stainless steel screw for PVC 6 x 45mm for CLSB (set of 25 pcs)	25 pcs	82206				set (25)	€ 11.00		
	ZSC	Stainless steel screw + butyl sealing TX 25 self drilling for TP - TPG - TPGL	pc	23963				pc	€ 1.17		
	ZSB/G	Stainless steel screw 5.5 x 32mm TX 25 self drilling	pc	20911	18740	31382	21596	pc	€ 0.52	€ 0.67	€ 0.82
	ZSB	Galvanised steel screw 5.5 x 25mm TX 25	pc	82416				pc	€ 0.52		
	SCR	Stainless steel screw 5.5 x 25mm TX 25 (set of 2 or 8 pcs) for KGAS & GASXL	2 st 8 st		81834 71975	81833 71974	81832 71904	set (2) set (8)		€ 4.12 € 10.30	€ 4.74 € 11.85
	PS48	Self drilling stainless Parker screw 4.8 x 25mm for stop	pc	8431	22595	31383	22598	pc	€ 0.50	€ 0.67	€ 0.77
	PST	Self tapping stainless screw 4.8 x 13 Torx	pc	30767				pc	€ 0.11		
	SCR	Stainless steel screw 4.8 x 16mm TX 25 for screens	25 pcs	71989				set (25)	€ 8.00		
	NP	Self drilling screw Hilti HPS 8/10	pc	52679				pc	€ 0.91		
	ZSR	Anchor plug HSA 8/75	pc	52640				pc	€ 3.49		
	BITS	Torxbit for stainless screw	pc	18744				pc	€ 3.30		

GROUP	TYPE	DESCRIPTION	QUANT.	ARTICLE NUMBER				UN.	PRICE / UNIT		
MT	MOUNTING ACCESSORIES DOUBLE ROOF			0	9010	7016 ST	RAL		0	STANDARD COLOURS	RAL *
	8421	Tube 16/1.5	6m	17912	17934	31376	17937	pc	€ 31.32	€ 51.03	€ 58.68
	8422	Threaded bar M10	3m	17979				pc	€ 15.07		
	8423	Central drawing	pc	24327	24329	31377	24331	pc	€ 68.40	€ 78.69	€ 90.49
	8420	Cover drawing	pc	24332	24333	31378	24335	pc	€ 19.11	€ 21.95	€ 25.24
	8424	End piece threaded bar	pc	17992	18061	31379	18064	pc	€ 16.72	€ 19.26	€ 22.15
	8425	Ridge fixing	pc	17993	18065	31380	18068	pc	€ 31.05	€ 58.39	€ 67.15
	8426	Eye bolt M10	pc	17980				pc	€ 29.32		
	8428	Stainless Nut M10	pc	17995				pc	€ 0.45		
	8427	Stainless bolt M10/30	pc	17994				pc	€ 0.90		
	8429	Safety nut M10	pc	17996				pc	€ 0.74		

GROUP	TYPE	DESCRIPTION	QUANT.	ARTICLE NUMBER				UN.	PRICE / UNIT		
MT	MOUNTING ACCESSORIES CLIMACROWN			0	9010	7016 ST	RAL		0	STANDARD COLOURS	RAL *

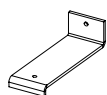

BEUG Bracket for GX - Climacrown pc 48040 pc € 6.61

## FINISHING



0: mill-finished aluminium or standard

RAL 9010 white / RAL 7016 ST anthracite structure: in stock (delivery time 3 weeks)

Other standard RAL colours: start up costs of € 200 net for each colour (delivery time on request)

\* any other RAL colour: +15% and start up cost of € 200 net for each colour (delivery time on request)

GROUP	TYPE	DESCRIPTION	QUANT.	ARTICLE NUMBER				UN.	PRICE / UNIT		
<b>MT</b> 	<b>MOUNTING ACCESSORIES CLIMACROWN</b>			<b>0</b>	<b>9010</b>	<b>7016 ST</b>	<b>RAL</b>		<b>0</b>	<b>STANDARD COLOURS</b>	<b>RAL *</b>
	HAAK	Hook for GX - Climacrown	pc	48041	48043	48044	48042	pc	€ 8.56	€ 17.47	€ 20.09
	BOUT	Stainless steel screw M5 x 20 for hook	pc	47595				pc	€ 0.42		
	MOER	Stainless steel nut M5	pc	25705				pc	€ 0.10		
	RING	Stainless steel ring M5	pc	25920				pc	€ 0.20		

GROUP	TYPE	DESCRIPTION	QUANT.	ARTICLE NUMBER				UN.	PRICE / UNIT		
	<b>MISCELLANEOUS</b>			<b>0</b>	<b>9010</b>	<b>7016 ST</b>	<b>RAL</b>		<b>0</b>	<b>STANDARD COLOURS</b>	<b>RAL *</b>
	LAK	Paint brush for repair	pc		24198	31385	24199	pc		€ 12.80	€ 25.50
	RAL	Colour change for RAL	pc	21782			21782	pc			€ 200.00
	RAL2	Colour change for structured lacquer	pc	22612			22612	pc			€ 200.00
	SILI	Silicon 310ml for use with PMMA and PC Warranty 10 year Blank & RAL = transparent	pc	15460 (transp)	4736	30378	15460 (transp)	pc	€ 11.38	€ 11.38	€ 11.38
	SG20	Silicon glue 310ml for glass connector GVB - GVT - L432 - L632	pc	27494 (grey)				pc	€ 38.45		
			pc	109085 (black)					pc	€ 38.45	

GROUP	TYPE	DESCRIPTION	QUANT.	ARTICLE NUMBER				UN.	PRICE / UNIT		
	<b>LED STRIPES</b>			<b>0</b>					<b>0</b>		
	LED	LED roll for GDGL IP67 - 24V - 7W/m - 120 dots/m	4.00m	49555				pc	€ 131.40		
			5.00m	49556				pc	€ 164.10		
			6.00m	49557				pc	€ 197.00		
			7.00m	49558				pc	€ 229.81		
	LEDCO	PC LED cover (for CC150 / CC225)	2.10m	45737				pc	€ 18.10		
3.10m			84999				pc	€ 25.00			
	TAPE	Tape for LED (roll 7m)	pc	35885				pc	€ 7.92		
	TRAN	Transfo for LED 24V 30W IP66 (for LED 4m)	pc	49559				pc	€ 59.00		
			pc	49560				pc	€ 101.32		
	AFST	Remote control 5 channels	pc	39640				pc	€ 96.76		
	ONT	Receiver remote with dimmer	pc	39641				pc	€ 185.03		
	KABES	Cable set for dimmer 2 x 0.5m	pc	49561				pc	€ 11.74		
	KABE	Cable for LED 6m	pc	31023				pc	€ 13.50		

GROUP	TYPE	DESCRIPTION	QUANT.	ARTICLE NUMBER				UN.	PRICE / UNIT		
	<b>LED SPOTS</b>			<b>0</b>					<b>0</b>		
	VTLED	Basic set for 6 LED spots	set	39629				set	€ 436.58		
	VTLED	Basic set for 12 LED spots	set	39630				set	€ 689.35		
	VTLED	Extension set for 3 LED spots	set	39628				set	€ 111.27		
	SPOT	LED spot Ø 35mm - 3W	pc	39617				pc	€ 37.00		
	AFST	Remote control 5 channels	pc	39640				pc	€ 96.76		
	ONT	Receiver remote with dimmer	pc	39641				pc	€ 185.03		
	TRAN30	Transformer for LED spots 24V 30W	pc	39652				pc	€ 120.92		
	TRAN60	Transformer for LED spots 24V 60W	pc	39653				pc	€ 195.93		
	BL3	Distributor 3 sockets	pc	39664				pc	€ 4.95		
	BL6	Distributor 6 sockets	pc	39665				pc	€ 5.91		

**FINISHING**

0: mill-finished aluminium or standard

RAL 9010 white / RAL 7016 ST anthracite structure: in stock (delivery time 3 weeks)

Other standard RAL colours: start up costs of € 200 net for each colour (delivery time on request)

\* any other RAL colour: +15% and start up cost of € 200 net for each colour (delivery time on request)

GROUP	TYPE	DESCRIPTION	QUANT.	ARTICLE NUMBER			UN.	PRICE / UNIT		
	<b>LED SPOTS</b>			<b>0</b>				<b>0</b>		
	KABEL5	Cable for spots 5m	pc	39676			pc	€ 5.81		
	KABEL7	Cable for spots 7m	pc	39677			pc	€ 7.26		
	KABEL9	Cable for spots 9m	pc	39678			pc	€ 8.70		
	JMP	Jumper bridge for distributor	pc	39642			pc	€ 0.73		







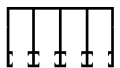

## FINISHING

0: mill-finished aluminium or standard

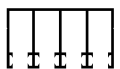
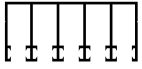
RAL 9010 white / RAL 7016 ST anthracite structure: in stock (delivery time 3 weeks)

Other standard RAL colours: start up costs of € 200 net for each colour (delivery time on request)

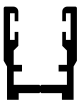









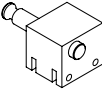
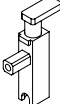

\* any other RAL colour: +15% and start up cost of € 200 net for each colour (delivery time on request)

GROUP	TYPE	DESCRIPTION	QUANT.	ARTICLE NUMBER				UN.	PRICE / UNIT		
<b>CG</b>	<b>CLIMAGLIDE</b>		<b>M</b>	<b>0</b>	<b>9010</b>	<b>7016 ST</b>	<b>RAL</b>		<b>0</b>	<b>STANDARD COLOURS</b>	<b>RAL *</b>
	CGT3.08	Upper rail for 3 or 6 glass sheets (8mm)	3	48505	48508	48507	48506	m	€ 45.56	€ 61.90	€ 61.90
4			48509	48512	48511	48510	m	€ 45.56	€ 61.90	€ 61.90	
6			48513	48516	48515	48514	m	€ 45.56	€ 61.90	€ 61.90	
	CGT4.08	Upper rail for 4 or 8 glass sheets (8mm)	4	48517	48520	48519	48518	m	€ 53.72	€ 80.60	€ 80.60
5			48521	48524	48523	48522	m	€ 53.72	€ 80.60	€ 80.60	
7			48525	48528	48527	48526	m	€ 53.72	€ 80.60	€ 80.60	
	CGT5.08	Upper rail for 5 or 10 glass sheets (8mm)	5	48529	48532	48531	48530	m	€ 59.56	€ 98.12	€ 98.12
7			48533	48536	48535	48534	m	€ 59.56	€ 98.12	€ 98.12	
	CGT3.10	Upper rail for 3 or 6 glass sheets (10mm)	3	80241	80244	80243	80242	m	€ 45.56	€ 61.90	€ 61.90
4			80245	80248	80247	80246	m	€ 45.56	€ 61.90	€ 61.90	
6			80249	80252	80251	80250	m	€ 45.56	€ 61.90	€ 61.90	
	CGT4.10	Upper rail for 4 or 8 glass sheets (10mm)	3	80253	80256	80255	80254	m	€ 53.72	€ 80.60	€ 80.60
4			80257	80260	80259	80258	m	€ 53.72	€ 80.60	€ 80.60	
5			80261	80264	80263	80262	m	€ 53.72	€ 80.60	€ 80.60	
7			80265	80268	80267	80266	m	€ 53.72	€ 80.60	€ 80.60	
	CGT5.10	Upper rail for 5 or 10 glass sheets (10mm)	5	80269	80272	80271	80270	m	€ 59.56	€ 98.12	€ 98.12
7			80273	80276	80275	80274	m	€ 59.56	€ 98.12	€ 98.12	
	CGB3	Lower rail for 3 or 6 glass sheets	3	48537				m	€ 26.86		
4			48538				m	€ 26.86			
6			48539				m	€ 26.86			
	CGB4	Lower rail for 4 or 8 glass sheets	3	80240				m	€ 33.88		
4			48540				m	€ 33.88			
5			48541				m	€ 33.88			
7			48542				m	€ 33.88			
	CGB5	Lower rail for 5 or 10 glass sheets	5	48543				m	€ 43.22		
7			48544				m	€ 43.22			
	CGL08	Alu side profile 8mm	2.5	48556	48559	48558	48557	pc	€ 54.90	€ 60.74	€ 60.74
	CGL10	Alu side profile 10mm without latch	2.5	81845	94716	94714	94713	pc	€ 54.90	€ 60.74	€ 60.74
			3	82270	94717	94715	94712	pc	€ 72.47	€ 81.02	€ 81.02
	CGL10	Alu side profile 10mm with latch for single system, opening left	2.5	80610	80634	80646	80622	pc	€ 183.38	€ 210.89	€ 210.89
3			80612	80636	80648	80624	pc	€ 192.79	€ 220.63	€ 220.63	
	CGL10	Alu side profile 10mm with latch for single system, opening right	2.5	80609	80633	80645	80621	pc	€ 183.38	€ 210.89	€ 210.89
3			80611	80635	80647	80623	pc	€ 192.79	€ 220.63	€ 220.63	
	CGSH	Anodised latch (without screws)		80332				pc	€ 30.79		
	CGPL08	Alu roller block profile 8mm	1	48560	48562	48563	48561	pc	€ 50.22	€ 67.74	€ 67.74
	CGPL10	Alu roller block profile 10mm	1	79726	79729	79728	79727	pc	€ 50.22	€ 67.74	€ 67.74
	GREEP02	Screw-on handle (8mm) made of anodised aluminium n D68/60		43661				pc	€ 54.90		
	GREEP02	Screw-on handle (8mm) made of stainless steel D68/60		49553				pc	€ 54.90		

## FINISHING

2 standard RAL colours: white 9010 and anthracite 7016 ST (delivery time 3 weeks) / no surcharge

\* Other RAL colours of choice: see p. 8 & 9 (start up costs of € 200) – delivery time on request

GROUP	TYPE	DESCRIPTION	QUANT.	ARTICLE NUMBER			UN.	PRICE / UNIT			
CG	CLIMAGLIDE		M	O	9010	7016 ST	RAL	O	STANDARD COLOURS	RAL *	
	GREEP03	Set of self-adhesive anodised handles (8 and 10mm)		80877				pc	€ 70.08		
	TOCHT01	Sealing brush, lacquered aluminium profile	2.5	43662	51924	51925	51923	pc	€ 42.04	€ 46.72	€ 46.72
	TOCHT03	Sealing brush, lacquered aluminium profile	3	81558	81560	81561	81559	pc	€ 58.40	€ 62.41	€ 62.41
	TOCHT07	Sealing brush in transparent PVC profile for 8mm	2.5	108095				pc	€ 18.28		
			3	108096				pc	€ 22.25		
		Sealing brush in transparent PVC profile for 10mm	2.5	108097				pc	€ 18.54		
			3	108098				pc	€ 22.56		
		Transparent glue for grip (200ml)		43663				pc	€ 98.04		
	DICHT01	Flexible middle panel seal for L + R systems made of PVC 8mm	2.5	81352				pc	€ 39.72		
	DICHT01	Flexible middle panel seal for L + R systems made of PVC 10mm	2.5	80942				pc	€ 39.72		
	CGLOOP	Roller block (without lock screw)		48569				pc	€ 29.20		
	LOOP04.10	Carrier set for Climaglide 10mm		80666				pc	€ 28.19		
	VTLOOP02B	POM rail for carrier system		52924				pc	€ 12.94		
	CGBL	Latch block (anodised)		48564				pc	€ 67.74		
	CGPLL08	Alu latch 8mm		48565	48567	48568	48566	pc	€ 56.06	€ 66.58	€ 66.58
	CGPLL10	Alu latch 10mm		79721	79735	79734	79733	pc	€ 56.06	€ 66.58	€ 66.58
	CGPLS08	Alu closing part for roller block profile 8mm		48570	48572	48573	48571	pc	€ 35.04	€ 44.38	€ 44.38
	CGPLS10	Alu closing part for roller block profile 10mm		79720	79732	79731	79730	pc	€ 35.04	€ 44.38	€ 44.38
	CGPLS10	Alu closing part for roller block profile 10mm – short version		80229	80232	80231	80230	pc	€ 35.04	€ 44.38	€ 44.38
	CGC	Rubber sealing for 8mm or 10mm glass	1	48545				pc	€ 2.34		
		Alu foundation profile 60 x 40 x 3mm	6	79752	51930	51929	81501	pc	€ 115.64	€ 192.72	€ 221.63
		Alu foundation profile 80 x 40 x 3mm	6	79753	51932	51931	81502	pc	€ 144.84	€ 224.26	€ 257.90
		Alu foundation profile 100 x 40 x 4mm	6	79754	51934	51933	81503	pc	€ 176.37	€ 256.96	€ 295.50
		Pre-mounted roller block 8mm	0.85	51990	51993	51992	51991	pc	€ 141.33	€ 141.33	€ 141.33
			1	51781	51784	51783	51782	pc	€ 147.17	€ 147.17	€ 147.17
			1.2	51785	51788	51787	51786	pc	€ 160.02	€ 160.02	€ 160.02
		Cost for customising pre-mounted roller blocks (non-standard)			79748	79748	79748	pc		€ 5.84	€ 5.84
		Not pre-mounted roller block 8mm	0.85	52921				pc	€ 131.98		
			1	52922				pc	€ 137.82		
			1.2	52923				pc	€ 150.68		

FINISHING | 2 standard RAL colours: white 9010 and anthracite 7016 ST (delivery time 3 weeks) / no surcharge  
 \* Other RAL colours of choice: see p. 8 & 9 (start up costs of € 200) – delivery time on request

## ACCESSORIES FOR SELF-SUPPORTING PROFILE SYSTEMS

### TRIANGLE

**NEW**

The Skylux triangle profiles allow you to build a triangle- or rectangular-shaped frame in which glass or plastic can be installed. The aluminium profiles are maintenance-friendly, coated in accordance with the Qualicoat standard and available in all RAL colours and structured coating.

#### *Profile 42mm – made to fit the roof*

- Triangle formed by 2 types of non-thermal aluminium profiles: a base profile and a clip profile.
- The dimensions depend on the veranda.
- A supporting cross-beam (110/72) is necessary.
- If requested, Skylux can cut the top inclined profiles to guarantee an easy installation.
- Skylux provides a vertical U-profile to seal to opening and an H-profile for the vertical partition.
- Suitable for 10mm glass or double-sided UV-resistant 16mm plastic sheets.
- The profiles are delivered to size with all necessary accessories: screws, plugs and rubbers.

- gross price per triangle with an 8° pitch
- cross-beam P72 (110/72) included
- standard colours: 9010 white and 7016 ST anthracite
- trend colours: black 9005 ST, white aluminium 9006 ST, grey aluminium 9007 ST, 9009 ST, 9010 ST, cream white 9001, purple red 3004 ST, RAL 7039 ST: standard price + € 200 surcharge for colour change
- other RAL colours: see p. 8 & 9 (+15% + fixed surcharge : € 200 net) – delivery time: on request

Depth	# partitions	Profile for glass 10mm	Profile for sheets 16mm	Surcharge sheet 16mm 3W 2UV
2500	3	€ 475.01	€ 486.21	€ 85.28
3000	3	€ 530.70	€ 540.17	€ 85.28
3500	4	€ 720.13	€ 723.53	€ 85.28
4000	4	€ 731.49	€ 733.16	€ 85.28
4500	5	€ 774.01	€ 765.89	€ 85.28
5000	5	€ 822.73	€ 812.88	€ 106.60





# WINDBREAK

**NEW**

- Protects against wind, sunlight, rain and creates privacy
- Combines perfectly with the Skylux triangle profiles
- Comes in 10mm glass or 16mm plastic sheets (double-sided UV-resistant)
- The number of panels can be configured by the customer
- Vertical H-profiles for partitions

The Skylux windbreak is installed below the triangle (p. 64) and is made of non-thermal aluminium frames.

The frames are provided with 10mm glass or 16mm plastic sheets (double-sided UV-resistant) and separated by aluminium H-profiles.

A useful solution to shield yourself from wind, sunlight, rain and to add privacy.

The windbreak is easy to configure. We deliver the frames with some margin on the dimensions to allow sufficient flexibility during installation.

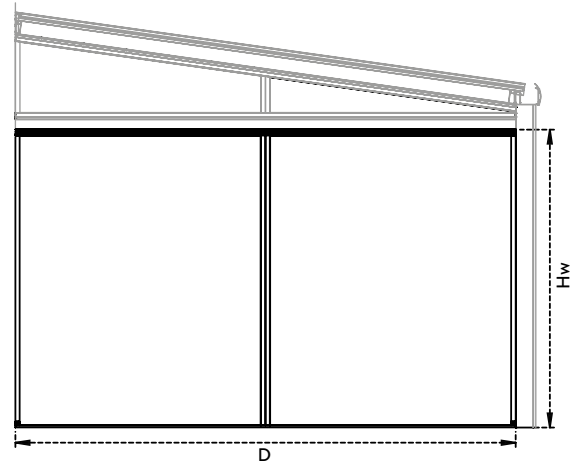

Depth	# partitions	Profile for glass 10mm	Profile for sheets 16mm	Surcharge sheet 16mm 3W 2UV
2500	3	€ 500.59	€ 474.00	€ 319.80
3000	3	€ 506.25	€ 477.93	€ 319.80
3500	4	€ 643.96	€ 594.69	€ 426.40
4000	4	€ 659.87	€ 608.87	€ 426.40
4500	5	€ 732.99	€ 661.04	€ 533.00
5000	5	€ 738.65	€ 664.97	€ 533.00



## CLIMAGLIDE

Climaglide is a custom-made profile system for glass sliding elements. This system, which is delivered together with your veranda roof, provides protection from wind and rain and therefore represents a significant added value. The profiles' elegant, contemporary look contributes to increased aesthetics. The aluminium profiles require minimal maintenance, are coated in accordance with the Qualicoat standard and are available in all RAL colours and structured coatings.

Combined with 8mm or 10mm tempered glass (not provided by Skylux), Climaglide ensures a tough and safe system. These sliding glass elements are made for single glazing. It can be locked from the inside and provides protection against wind and rain. You can slide the elements separately to 1 or 2 sides (depending on which version you choose) to create a large opening. Or you can choose a carrier system which carries the glass panels to the direction you slide to (only available for 10mm). Elements that slide open to 2 sides are provided with a middle panel seal.

Climaglide can be installed in patio roofs without thermal break like Climax Panorama, Climalux and Climalux Horizon.

Climaglide is available in three versions:

- 8mm Basic: 8mm tempered glass (not provided by Skylux) with pre-mounted roller blocks for glass elements that can slide separately – cannot be locked – not pre-drilled.
- 8mm lockable: 8mm tempered glass (not provided by Skylux) with pre-mounted roller blocks for glass elements that can slide separately – can be locked. The bottom rail (CGB) with 3, 4 or 5 tracks is completely pre-drilled. Available accessories: - screw-on handles D65/50 made of anodised aluminium – set of 2 self-adhesive anodised aluminium handles with cleaning cloth – glue to attach the draught strips and brush seals in the same ordered RAL colour
- 10mm lockable: 10mm tempered glass (not provided by Skylux) with pre-mounted roller blocks for carrier system and a latch on one side. The bottom rail (CGB) with 3, 4 or 5 tracks is completely pre-drilled.

Available accessories: brush seals in the same ordered RAL colour

<b>Climaglide 8mm Basic (no wall profile, no latch block)</b>						
Max. height 2350mm						
Width in mm						
System	2000	2400	2800	3200	3600	
3 tracks 2 glass elements	€ 1055	€ 1094				
3 tracks 3 glass elements	€ 1055	€ 1094	€ 1097	€ 1154		
3 tracks 6 glass elements				€ 1343	€ 1399	
4 tracks 4 glass elements *	€ 1139	€ 1241	€ 1244	€ 1260	€ 1264	
4 tracks 8 glass elements						
5 tracks 5 glass elements			€ 1411	€ 1431	€ 1433	
5 tracks 10 glass elements						

<b>Climaglide 8mm with separate elements</b>						
Max. height 2350mm						
Width in mm						
System	2000	2400	2800	3200	3600	
3 tracks 2 glass elements	€ 1191	€ 1231				
3 tracks 3 glass elements	€ 1193	€ 1235	€ 1235	€ 1294		
3 tracks 6 glass elements				€ 1668	€ 1707	
4 tracks 4 glass elements *	€ 1382	€ 1488	€ 1488	€ 1507	€ 1510	
4 tracks 8 glass elements						
5 tracks 5 glass elements			€ 1659	€ 1678	€ 1681	
5 tracks 10 glass elements						

<b>Climaglide 10mm with carrier system</b>						
Standard height 2500mm **						
Width in mm						
System	2000	2400	2800	3200	3600	
3 tracks 2 glass elements	€ 1370	€ 1404				
3 tracks 3 glass elements	€ 1441	€ 1478	€ 1483	€ 1533		
3 tracks 6 glass elements					€ 1807	
4 tracks 4 glass elements *	€ 1572	€ 1668	€ 1671	€ 1690	€ 1693	
4 tracks 8 glass elements						
5 tracks 5 glass elements			€ 1966	€ 1986	€ 1988	
5 tracks 10 glass elements						

\* for 3 tracks - 4 glass elements as L+R system: price 4 tracks + € 38

\*\* surcharge max. height for double system (L + R): 2620mm and for single system (L or R): 3000mm: + € 89



Width in mm							
4000	4400	4800	5200	5600	6000	6400	6800
€ 1414	€ 1495	€ 1514	€ 1517	€ 1519	€ 1536		
€ 1285	€ 1343	€ 1349					
		€ 1642	€ 1748	€ 1764	€ 1783	€ 1786	€ 1790
€ 1456	€ 1531	€ 1539	€ 1693	€ 1695			
			€ 2027	€ 2030	€ 2047	€ 2053	€ 2056

Width in mm							
4000	4400	4800	5200	5600	6000	6400	6800
€ 1725	€ 1807	€ 1822	€ 1824	€ 1828	€ 1844		
€ 1533	€ 1591	€ 1597					
		€ 2074	€ 2193	€ 2197	€ 2216	€ 2220	€ 2223
€ 1704	€ 1780	€ 1812	€ 1941	€ 1944			
			€ 2534	€ 2537	€ 2553	€ 2564	€ 2569

Width in mm							
4000	4400	4800	5200	5600	6000	6400	6800
€ 1824	€ 1898	€ 1915	€ 1918	€ 1922	€ 1937		
€ 1712	€ 1735	€ 1773					
		€ 2206	€ 2332	€ 2335	€ 2351	€ 2354	€ 2357
€ 2012	€ 2085	€ 2091	€ 2245	€ 2248			
			€ 2693	€ 2698	€ 2717	€ 2719	€ 2726

The above mentioned prices are valid for standard colours RAL9010 and 7016 ST. For other RAL colours, there is a surcharge of € 200 for each order.

## VERTICAL SUNBLIND

### *Add privacy, coolness and shade*

- Made to fit
- Frames perfectly match the colour of your roof
- Compatible with Skylux patio roofs
- Can be fitted to the front or the sides
- Supplied with the latest Somfy io actuators

Blinds are essential during the warm summer months. A well-fitted blind protects you from insects, from the heat of the sun and the chill of the wind. Skylux's new veranda blinds help you to stay cool and they also screen out the glare associated with winter sun. Our premium quality blinds protect your privacy and enable you to stay comfortable, all year round.



#### Gross prices Skylux (standard colour) with adapter set

H/W (mm)	1000	1200	1400	1600	1800	2000	2200	2400	2600	2800	3000	3200	3400
2000	€ 1078	€ 1131	€ 1182	€ 1238	€ 1292	€ 1344	€ 1396	€ 1447	€ 1531	€ 1581	€ 1634	€ 1687	€ 1738
2100	€ 1095	€ 1149	€ 1206	€ 1259	€ 1315	€ 1369	€ 1422	€ 1506	€ 1558	€ 1617	€ 1670	€ 1723	€ 1779
2200	€ 1113	€ 1171	€ 1227	€ 1282	€ 1340	€ 1396	€ 1454	€ 1537	€ 1593	€ 1652	€ 1707	€ 1764	€ 1820
2300	€ 1130	€ 1188	€ 1246	€ 1306	€ 1365	€ 1422	€ 1507	€ 1567	€ 1623	€ 1683	€ 1742	€ 1799	€ 1860
2400	€ 1146	€ 1207	€ 1268	€ 1327	€ 1386	€ 1447	€ 1535	€ 1597	€ 1656	€ 1719	€ 1777	€ 1836	€ 1896
2500	€ 1161	€ 1225	€ 1286	€ 1349	€ 1411	€ 1475	€ 1563	€ 1623	€ 1688	€ 1751	€ 1814	€ 1876	€ 1936
2600	€ 1180	€ 1245	€ 1310	€ 1374	€ 1436	€ 1532	€ 1593	€ 1657	€ 1721	€ 1785	€ 1848	€ 1913	€ 1981
2700	€ 1197	€ 1263	€ 1330	€ 1396	€ 1462	€ 1555	€ 1620	€ 1687	€ 1755	€ 1820	€ 1884	€ 1951	€ 2019
2800	€ 1212	€ 1280	€ 1349	€ 1417	€ 1511	€ 1581	€ 1650	€ 1718	€ 1783	€ 1849	€ 1923	€ 1991	€ 2057
2900	€ 1230	€ 1298	€ 1369	€ 1438	€ 1537	€ 1607	€ 1674	€ 1746	€ 1817	€ 1885	€ 1955	€ 2023	€ 2097
3000	€ 1246	€ 1319	€ 1392	€ 1463	€ 1559	€ 1634	€ 1706	€ 1777	€ 1847	€ 1923	€ 1995	€ 2067	€ 2099
<b>Casing 103 Axle 78</b>													

Prices are valid for standard and trend colours. Other RAL colours +15%

## Concept

- Enjoy flawless fitted blinds with aluminium frames that perfectly match the colour of your roof. Skylux's blinds are fully compatible with the Climax, Climalux, Climalux Horizon, Climax Panorama and Climacrown veranda systems. The ZIP system ensures excellent fit, providing superior protection against insects and the wind. Blinds can be fitted to the front or sides of the veranda, giving you the coverage options that work best for you.

Casing 103mm 90° (straight casing) for screens up to 4.5m wide

Casing 131mm 90° (straight casing) for screens up to 6m wide



- Skylux blinds are woven with high-quality PVC coated glass fibre.
- By choosing to pair your blind with an adapter profile, you can hide your screen cables and avoid wrinkles in the fabric, achieving a sleek and neat finish.
- Available in more than 50 standard colours. View the overview on p. 70 & 71.
- All Skylux blinds are supplied with the latest Somfy io actuators, enabling you to control your blinds by remote control or a wall switch. We also offer automatic motors that respond to solar or wind exposure levels.

### Remote control Somfy

Name	Description	Price
① Situo 1 io Pure	Remote control 1 channel	€ 38
② Situo 5 io Pure	Remote control 4 channels (operates multiple screens)	€ 67
③ Smoove 1 io Pure	Switch 1 channel, no cable	€ 42
④ Smoove 4 io Pure	Switch 4 channels, no cables	€ 148
⑤ Sunis II IO	Wireless solar detector, controls your blinds to your preferences	€ 212
⑥ Eolis WireFree io	Wireless wind detector, retracts your blinds based on wind exposure	€ 175

3600	3800	4000	4200	4400	4500	4600	4800	5000	5200	5400	5600	5800	6000
€ 1793	€ 1845	€ 1896	€ 1962	€ 2020	€ 2071	€ 2669	€ 2728	€ 2791	€ 2869	€ 2930	€ 2994	€ 3057	€ 3119
€ 1833	€ 1888	€ 1944	€ 2010	€ 2067	€ 2121	€ 2758	€ 2823	€ 2890	€ 2969	€ 3034	€ 3098	€ 3165	€ 3231
€ 1879	€ 1932	€ 1991	€ 2059	€ 2117	€ 2173	€ 2758	€ 2823	€ 2890	€ 2969	€ 3034	€ 3098	€ 3165	€ 3231
€ 1919	€ 1979	€ 2035	€ 2110	€ 2169	€ 2230	€ 2848	€ 2916	€ 2986	€ 3069	€ 3139	€ 3209	€ 3280	€ 3349
€ 1958	€ 2019	€ 2080	€ 2154	€ 2213	€ 2275	€ 2848	€ 2916	€ 2986	€ 3069	€ 3139	€ 3209	€ 3280	€ 3349
€ 1999	€ 2061	€ 2122	€ 2198	€ 2262	€ 2326	€ 2939	€ 3011	€ 3084	€ 3168	€ 3243	€ 3316	€ 3389	€ 3460
€ 2044	€ 2106	€ 2132	€ 2169	€ 2194	€ 2218	€ 2939	€ 3011	€ 3084	€ 3168	€ 3243	€ 3316	€ 3389	€ 3460
€ 2084	€ 2113	€ 2175	€ 2256	€ 2320	€ 2991	€ 3028	€ 3103	€ 3180	€ 3271	€ 3348	€ 3425	€ 3503	€ 3579
€ 2087	€ 2155	€ 2223	€ 2305	€ 2953	€ 2991	€ 3028	€ 3103	€ 3180	€ 3271	€ 3348	€ 3425	€ 3503	€ 3579
€ 2125	€ 2198	€ 2269	€ 2961	€ 3041	€ 3081	€ 3117	€ 3196	€ 3276	€ 3369	€ 3451	€ 3530	€ 3609	€ 3690
€ 2170	€ 2242	€ 2318	€ 2961	€ 3041	€ 3081	€ 3117	€ 3196	€ 3276	€ 3369	€ 3451	€ 3530	€ 3609	€ 3690
Casing 131 Axle 100													



# Vertical sunblind

## Add privacy, coolness and shade

### Concept

- Made to fit with high-quality PVC coated glass fibre and frames matching the colour of your roof.
- Compatible with our Climax, Climalux, Climalux Horizon, Climax Panorama and Climacrown patio roofs.
- Can be fitted to the front or the sides.
- The Skylux blind is provided with an adapter profile that allows you to hide your screen cables.



### MORE STANDARD COLOURS AVAILABLE

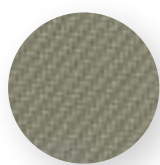

CSC3131

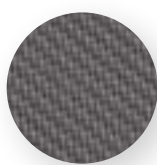

CSC3301



MSC1111



MSC4949



MSC5959



MSC6060

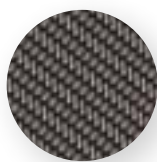

MSCM38



SC0101

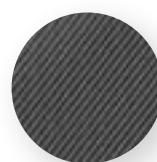

SC0130

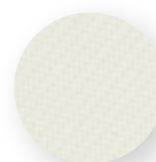

SC0202

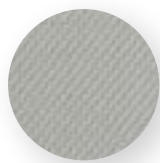

SC0707



SC2002

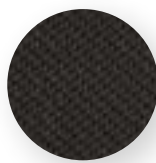

SC3006



SC3030

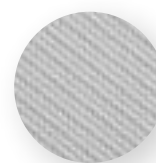

SCM36

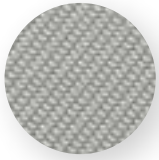

SCM31

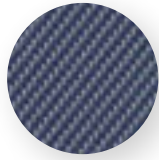

CS0140

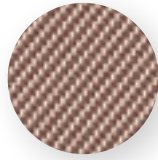

CSC0816

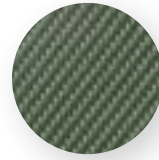

CSC001044



CSC001045

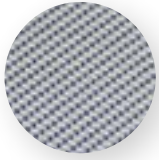

CSC2040

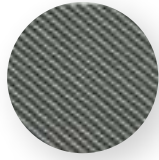

CSC2050

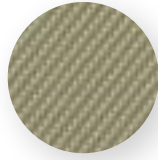

CSC3231

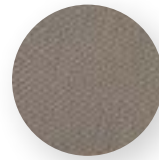

CSC3332

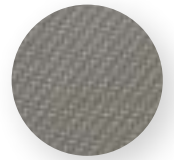

CSC3333

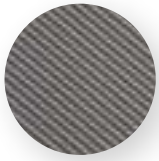

CSC008001



CSC032040

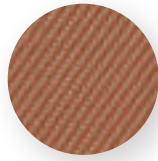

CSC033041

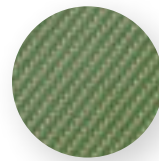

CSC033043

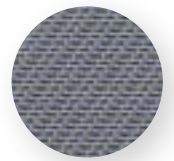

CSCM33

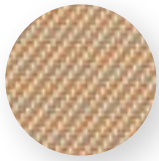

CSCM48

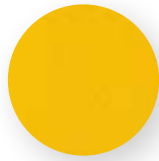

MSC0505

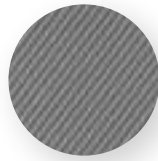

MSC0701

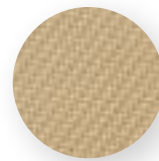

MSC1010



MSC4040

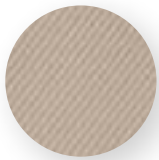

MSCM37



MSCM45

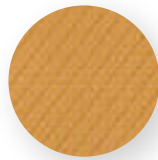

MSCM65

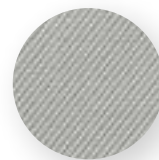

SC0102

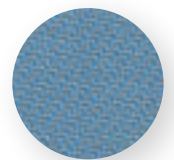

SC0103



SC0105

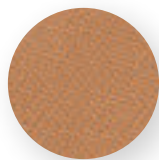

SC0108

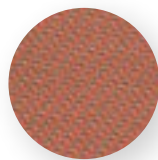

SC0109

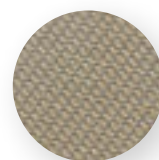

SC0110



SC0207



SC0606

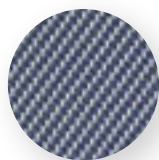

SC0740

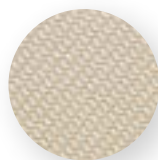

SC1002

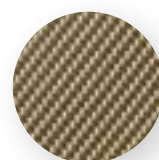

SC1006

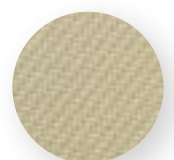

SC2020

## Cristal windows for vertical sunblinds

### Type 1 – Continuous window over the full width

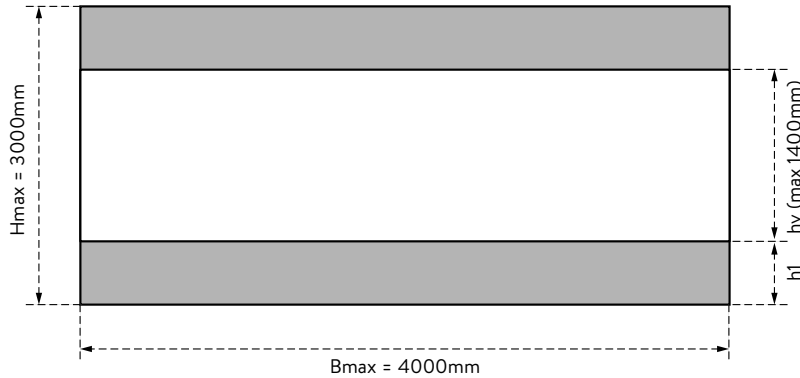

### Type 2 – Window with side borders

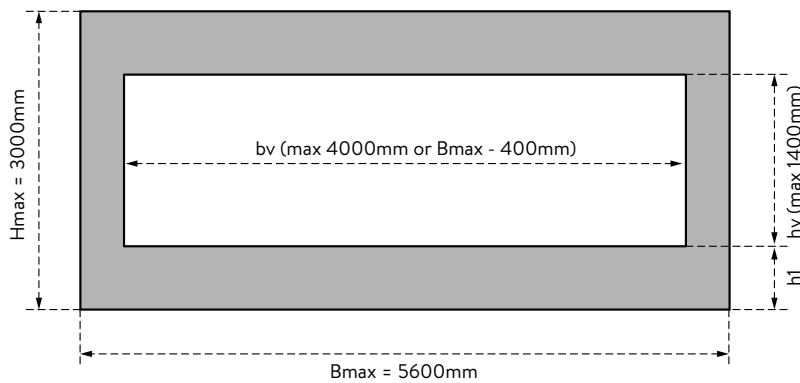

### Surcharge for Cristal window

Gross prices Skylux - Surcharge for Cristal window											
Window width	1000	1200	1400	1600	1800	2000	2200	2400	2600	2800	3000
Type 1	€ 155	€ 157	€ 159	€ 161	€ 162	€ 164	€ 166	€ 168	€ 170	€ 171	€ 173
Type 2	€ 266	€ 281	€ 296	€ 312	€ 327	€ 342	€ 357	€ 372	€ 388	€ 403	€ 418
<b>Casing 103 Axle 78</b>											
Window width	3200	3400	3600	3800	4000						
Type 1	€ 644	€ 656	€ 671	€ 683	€ 695						
Type 2	€ 902	€ 927	€ 956	€ 981	€ 1007						
<b>Casing 131 Axle 100</b>											

The following dimensions must be specified when ordering:

- window type
- $h_1$ : height from bottom bar to window
- $h_v$ : window height (max. 1400mm)
- $b_v$ : window width (only for type 2)







## CLIMALED

### Spots

This lighting profile with pre-mounted LED spotlights provides the ideal lighting for your veranda or canopy and is mounted discreetly under the rafters. The long-lasting LED spotlights produce a warm white light that can be dimmed using the remote control, enabling you to create the required lighting ambience, from soft atmospheric to bright functional lighting. These pre-cabled lighting profiles (3 spotlights per profile) can be installed very easily and quickly.

A lighting set Climalux spots includes:

- two or more colour coated aluminium profiles with 3 built-in LED spots
- a transformer 230/24V DC 30W or 60W depending on the number of spots
- a remote control
- the wiring between the spots and the transformer
- the assembly accessories

Depth D (mm)	Colour	Number of lighting profiles						
		2	3	4	5	6	7	8
2500-4000 ( $\alpha_{max} = 20^\circ$ )	Standard	€ 692.43	€ 931.63	€ 1201.05	€ 1440.25	€ 1679.45	€ 2132.68	€ 2402.11
	Special RAL*	€ 730.30	€ 988.42	€ 1276.78	€ 1534.91	€ 1793.04	€ 2265.21	€ 2553.56
4001-5000 ( $\alpha_{max} = 20^\circ$ )	Standard	€ 739.54	€ 1002.28	€ 1295.26	€ 1558.01	€ 1820.76	€ 2297.54	€ 2590.52
	Special RAL*	€ 784.46	€ 1069.66	€ 1385.10	€ 1670.31	€ 1955.52	€ 2454.76	€ 2770.20
5001-6000 ( $\alpha_{max} = 20^\circ$ )	Standard	€ 771.83	€ 1050.73	€ 1359.86	€ 1638.76	€ 1917.65	€ 2410.59	€ 2719.72
	Special RAL*	€ 821.59	€ 1125.37	€ 1459.38	€ 1763.15	€ 2066.93	€ 2584.74	€ 2918.75

The standard colours are white (RAL 9010) and anthracite structured (RAL 7016 ST) and the trend RAL colours of Climalux

\* For orders without a patio roof, there is a surcharge of € 200 for the colour change

Our cable ducts offer the neat option to hide the Climalux cables. Providing a cable duct for your Skylux patio roof creates an added value, especially to facilitate the installation of Climalux if your customer wishes to have LED lighting afterwards.

The cable duct is available for Climalux/Climalux Horizon/Climax and Climax Panorama.

Please note: the roof slope is limited (max. 20°) in case of a wall-mounted Climax or Cimax Panorama with cable duct.



### Stripes

An LED light strip can also be integrated into the gutter. This LED lighting emits a beautiful, soft and pleasant warm white light.

A lighting set Climalux strip includes:

- one colour coated aluminium profile GDGL (Climalux)
- one LED strip 24V (120 LEDs /m)
- a transformer 230/24V DC 30W or 60W
- the wiring (6m) between the LED strip and the transformer
- the assembly accessories

	Length (m)	4	5	6	7
Climalux	Standard	€ 238.18	€ 319.79	€ 359.28	€ 398.68
	Special RAL*	€ 242.14	€ 324.74	€ 365.22	€ 405.61
Climax Panorama	Standard	€ 203.90	€ 278.92	€ 311.82	€ 344.63
	Special RAL*	€ 203.90	€ 278.92	€ 311.82	€ 344.63

The standard colours are white (RAL 9010) and anthracite structured (RAL 7016 ST) and the trend RAL colours of Climalux

Additional cost for model with remote control, receiver and dimmer: + € 293.53

\* For orders without a patio roof, there is a surcharge of € 200 for the colour change

## NON-SELF-SUPPORTING PROFILE SYSTEMS

### PERGOLUX

#### Profiles for a timber supporting structure

Any construction with multi-walled plastic sheets requires non-self-supporting aluminium profiles. These profiles must be mounted on timber or steel rafters before fixing the sheets into them. The multi-walled sheets are not screwed. Heat can cause the multi-walled plastics sheets to expand and can cause cracks. The aluminium profiles allow the sheets to move enough to prevent these cracks. We offer different types of profiles to click or to drill in plastic material or in aluminium. The choice is yours!

The Pergolux D-series can be assembled with “shim tape” or as a full set. Thanks to the high-quality profiles, your conservatory roof will have an elegant design.



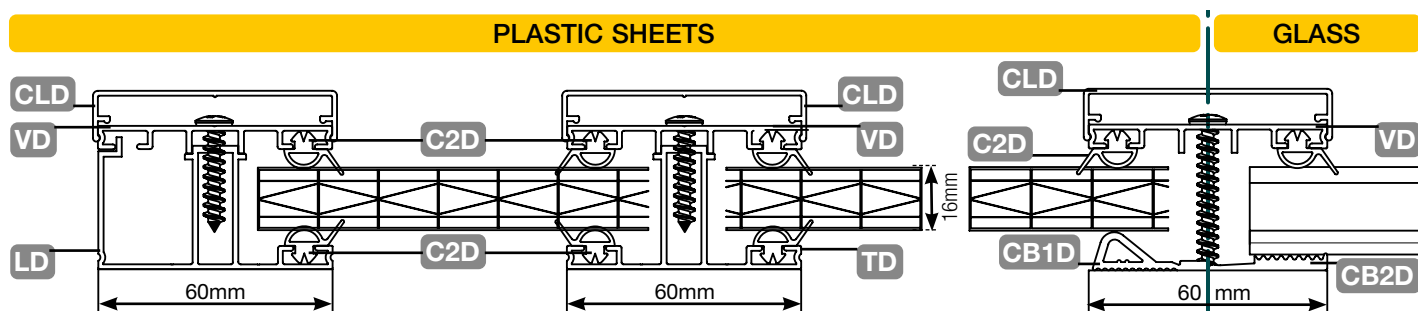

## Price list Pergolux D-series





GROUP	TYPE	DESCRIPTION	LENGTH	ARTICLE	UNIT	PRICE / UNIT
<b>WALL PROFILE</b>			<b>M</b>	<b>O</b>	<b>W</b>	<b>O</b> <b>W</b>
	MD	Wall profile (122mm width)	4.1	25125	m	€ 13.00
			5.1	25649	m	€ 13.00
			6.1	25126	m	€ 13.00
			7.1	25650	m	€ 13.00

GROUP	TYPE	DESCRIPTION	LENGTH	ARTICLE	UNIT	PRICE / UNIT		
<b>RAFTER AND SIDE RAFTER</b>			<b>M</b>	<b>O</b>	<b>W</b>	<b>O</b> <b>W</b>		
	TD	Rafter TD	2.5	30348	m	€ 10.85		
			3	29457	m	€ 10.85		
			3.5	29458	m	€ 10.85		
			4	25101	m	€ 10.85		
			5	25102	m	€ 10.85		
			6	25103	m	€ 10.85		
			7	25104	m	€ 10.85		
	LD	Side rafter LD	2.5	30347	m	€ 11.65		
			3	29455	m	€ 11.65		
			3.5	29456	m	€ 11.65		
			4	25105	m	€ 11.65		
			5	25106	m	€ 11.65		
			6	25107	m	€ 11.65		
			7	25108	m	€ 11.65		
	VD	Connecting profile VD	2.5	32327	m	€ 6.39		
			3	29459	m	€ 6.39		
			3.5	29460	m	€ 6.39		
			4	25097	m	€ 6.39		
			5	25098	m	€ 6.39		
			6	25099	m	€ 6.39		
			7	25100	m	€ 6.39		
	CLD	Clip cover for rafter and side rafter	4	25113	25121*	m	€ 5.42	€ 8.40
			5	25114	25122*	m	€ 5.42	€ 8.40
			6	25115	25123*	m	€ 5.42	€ 8.40
			7	25120	25124*	m	€ 5.42	€ 8.40
	Y16D	Filling profile for rafter TD	3	44709		m	€ 5.22	
			3.5	44710		m	€ 5.22	
			4	44711		m	€ 5.22	
			7	44712		m	€ 5.22	

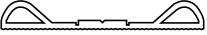
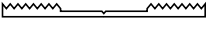
FINISH | O = mill finished aluminium / W = white or RAL 9010  
 \* Delivery time on request

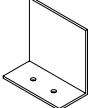
GROUP	TYPE	DESCRIPTION	LENGTH	ARTICLE		UNIT	PRICE / UNIT	
RUBBER			M	O	W		O	W
	C1D	Sealing for wall profile coex white	100 *		25130	m		€ 3.45
	C2D	Sealing for wall profile coex white for DT, DL and DV	200 *		25131	m		€ 1.79
	CB1D	Soft rubber strip coex white	50 *		25133	m		€ 5.22
	CB2D	Ribbed inferior strip - black	50 *	25134		m	€ 3.59	

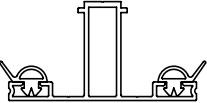
GROUP	TYPE	DESCRIPTION	LENGTH	ARTICLE		UNIT	PRICE / UNIT	
STOP				O			O	
	SD	L-shaped stop for aluminium profiles	pc	46546		pc	€ 3.22	

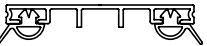









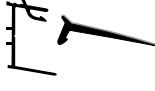
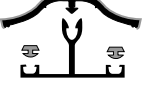

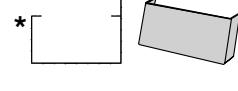

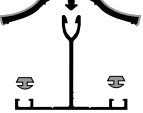
GROUP	TYPE	DESCRIPTION	LENGTH	ARTICLE		UNIT	PRICE / UNIT	
PROFILES WITH PRE-MOUNTED RUBBER			M	O	W		O	W
	ETD	Rafter TD with 2 x rubber C2D	2.5	32329		m	€ 15.43	
			3	29591		m	€ 15.43	
			3.5	29592		m	€ 15.43	
			4	25138		m	€ 15.43	
			5	25171		m	€ 15.43	
			6	25172		m	€ 15.43	
			7	25173		m	€ 15.43	
	ELD	Side rafter LD with rubber C2D	2.5	32331		m	€ 13.94	
			3	29593		m	€ 13.94	
			3.5	29594		m	€ 13.94	
			4	25174		m	€ 13.94	
			5	25175		m	€ 13.94	
			6	25176		m	€ 13.94	
			7	25177		m	€ 13.94	
	EVD	Connecting profile VD with 2 x rubber C2D	2.5	32333		m	€ 10.97	
			3	32334		m	€ 10.97	
			3.5	32335		m	€ 10.97	
			4	32336		m	€ 10.97	
			5	32338		m	€ 10.97	
			6	32339		m	€ 10.97	
			7	32340		m	€ 10.97	

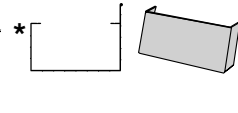
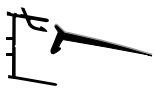
FINISH | O = mill finished aluminium or rubber black / W = white or RAL 9010  
 \* Length per roll, the rubbers are available in multiple profile lengths

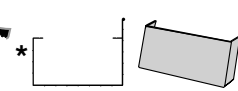
## Standard series

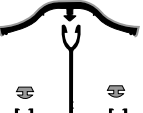
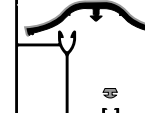
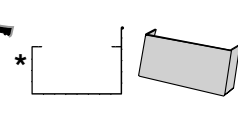
<p><b>ALU</b></p>	<p><b>ALU:</b> System with aluminium profiles and standard grey coex rubber</p>	
<p><b>COLOR</b></p>	<p><b>COLOR:</b> System with powder coated aluminium profiles (white RAL 9010) and white coex rubber</p>	
<p><b>COLOR-THERM</b></p>	<p><b>COLOR-THERM:</b> System with thermal break and powder coated aluminium clip (white RAL 9010, anthracite RAL 7016 ST and brown RAL 8019)</p>	
<p><b>COLOR-THERM GLASS</b></p>	<p><b>COLOR-THERM GLASS:</b> System with thermal break and screwable aluminium clip (white RAL 9010, anthracite RAL 7016 ST, brown RAL 8019 or any other RAL colour of your choice)</p>	

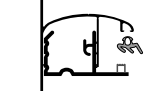
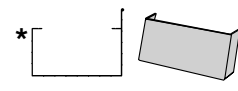
CA = sheet width + 22mm

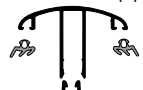
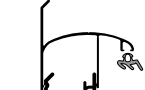
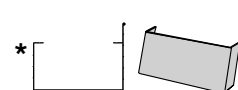
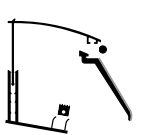
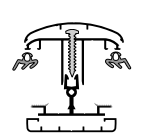
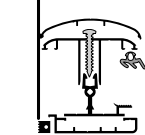
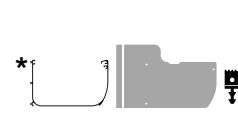



	WALL	RAFTER	SIDE RAFTER	GUTTER	ACCESSORIES					
16mm	M16 + C4CX 	T16.1 + C2CX + C3 (x2) 	L16 + C3 + C4CX 	G120A + G120AS + C6 	S16C	BT16	BB16	U16P	BM	ALU
32mm	M32T + M32B + C4CX 	T32.1 + C2CX + C3 (x2) 	L32.1 + C4CX + C3 	G120A + G120AS + C6 	S32C	BT32	BB32	U32P	BM	
16mm	M16 + C4CX 	T16.2 + C2CX + C3 (x2) 	LT16 + C3 + C2CX 	G120A + G120AS + C6 	S16C	BT16	BB16	U16	BM	COLOR
32mm	M32T + M32B + C4CX 	T32.1 + C2CX + C3 (x2) 	LT32 + C2CX + C3 	G120A + G120AS + C6 	S32C	BT32	BB32	U32A	BM	
16mm	CLM + MP + C1CX + C12 	T16P + CL16 + C8 (x2) 	CLL + LP + C8 	G120A + G120AS + C6 	S16.3	BT16	BB16	U16		COLOR-THERM
32mm	CLM + MP + C1CX + C12 	T16P + CL32 + C8 (x2) 	CLL + LP + C8 	G120A + G120AS + C6 	S32.3	BT32	BB32	U32		
8mm to 34mm	CLM + MP + C1CX + C12 + C31 	TPH + TPG + CLSB + CLST + C8 (x2) + screw 	TPHL + TPGL + CLSB + CLSL + C31 + C8 + screw 	G + GAS1 + C13 + C6 	S38.3	L432	Y16P	C11CX		COLOR-THERM GLASS

\* to combine with gutter top piece GR

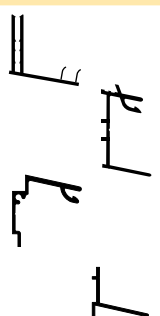
## Price list Pergolux

### 1. Profiles

GROUP	TYPE	DESCRIPTION	LENGTH	ARTICLE NUMBER			UN.	PRICE / UNIT		
M	WALL PROFILES		M	O	W 9010	B 8019	RAL	O	W/B	
	MP	PVC wall profile with soft supporting lips for sheets 16, 25 and 32mm for use with CLM profile	3.5		17756	17689		m	-	€ 11.47
			5		17757	17754		m		
			7		17758	17755		m		
	M16	Alu wall profile without lip for 16mm sheets	3.5	13257	15468			m	€ 13.19	€ 15.06
			5	13258	15469			m		
			7	13259	15470			m		
	M32T	Alu wall profile "top" for sheets > 20mm	3.5	13268	13501			m	€ 11.87	€ 14.31
			5	13269	13502			m		
			7	13270	13503			m		
	M32B	Alu wall profile "bottom" for sheets > 20mm	3.5	13277				m	€ 7.90	-
			5	13280				m		
			7	13281				m		

GROUP	TYPE	DESCRIPTION	LENGTH	ARTICLE NUMBER			UN.	PRICE / UNIT		
T	RAFTERS		M	O	W 9010	B 8019	RAL	O	W/B	
	T16P	PVC rafter with soft bulbs Not for glass	2.5		13202	13209		m	-	€ 10.02
			3		13203	13210		m		
			3.5		13204	13211		m		
			4		13205	13212		m		
			5		15588	15587		m		
			6		13206	13213		m		
			7		13207	13214		m		
	T16.1	Alu rafter for 16mm sheets	2.5	13170				m	€ 8.87	-
			3	13171				m		
			3.5	13172				m		
			4	13173				m		
			5	14537				m		
			6	13174				m		
			7	13175				m		
	T16.2	Alu rafter for 16mm sheets (self supporting till 80cm)	2.5	13178	13185			m	€ 11.44	€ 14.61
			3	13179	13186			m		
			3.5	13180	13187			m		
			4	13181	13188			m		
			5	14538	14606			m		
			6	13182	13189			m		
			7	13183	13190			m		
	T32.1	Alu rafter for 32mm sheets (self supporting till 100cm)	2.5	14223	14392			m	€ 9.63	€ 14.58
			3	14224	14393			m		
			3.5	14225	14394			m		
			4	14226	14395			m		
			5	14227	14396			m		
			6	14228	14397			m		
			7	14229	14398			m		
	TP	PVC thermal rafter profile for sheets	3.2		21278			m	-	€ 10.48
			3.7		21279			m		
			4.2		21280			m		
			5.2		24468			m		
			6.2		21281			m		

FINISH

O : mill finished aluminium / W : white or RAL 9010 / B : brown or RAL 8019 in stock  
RAL colour cost possible for order Color-Therm Glass : +15% on price of white and with start up cost of + € 200 net



GROUP	TYPE	DESCRIPTION	LENGTH	ARTICLE NUMBER			UN.	PRICE / UNIT		
T	RAFTERS		M	O	W 9010	B 8019	RAL	O	W/B	
	TPG	PVC thermal rafter profile for glass	4.2		25055			m	-	€ 10.48
			5.2		25056			m		
			6.2		25057			m		
			7.2		25058			m		
	TPH	Alu support profile for TP - TPG	2.6	22580	22585	22590	24414	m	€ 6.53	€ 9.87
			3.1	22581	22586	22591	24337	m		
			3.6	22582	22587	22592	24415	m		
			4.1	22583	22588	22593	24416	m		
			5.1	25066	25067	25068	25072	m		
			6.1	22584	22589	22594	24417	m		

GROUP	TYPE	DESCRIPTION	LENGTH	ARTICLE NUMBER			UN.	PRICE / UNIT		
L	SIDE RAFTERS		M	O	W 9010	B 8019	RAL	O	W/B	
	LP	PVC side profile with soft bulb for sheets 16, 25 and 32mm Use with CLL and C8	2.5		17767	17759		m	-	€ 12.34
			3		17768	17760		m		
			3.5		17769	17761		m		
			4		17770	17762		m		
			5		17771	17763		m		
			6		17772	17764		m		
			7		17773	17765		m		
	L16	Alu side profile for 16mm sheets	2.5	13221				m	€ 9.32	-
			3	13222				m		
			3.5	13223				m		
			4	13224				m		
			5	14624				m		
			6	13225				m		
			7	13226				m		
	L16P	Alu side finishing profile for 16, 25, 32mm sheets	2.5	16718	15478	15484	21231	m	€ 11.87	€ 13.64
			3	16719	15479	15485	21232	m		
			3.5	16720	15480	15486	21233	m		
			4	16721	15481	15487	21234	m		
			5	16722	15482	15488	21235	m		
			7	16723	15483	15489	21237	m		
	LT16	Alu side profile for 16mm sheets	2.5	15490	15534			m	€ 13.53	€ 16.92
			3	15491	15535			m		
			3.5	15492	15536			m		
			4	15493	15537			m		
			5	15495	15538			m		
			6	15496	15539			m		
			7	15497	15540			m		
	L32.1	Alu side profile for sheets >= 25mm	2.5	14230				m	€ 10.77	€ 16.02
			3	14231				m		
			3.5	14232				m		
			4	14233				m		
			5	14234				m		
			6	14235	14456			m		
			7	14238	14457			m		

FINISH | O : mill finished aluminium / W : white or RAL 9010 / B : brown or RAL 8019 in stock  
RAL colour cost possible for order Color-Therm Glass : +15% on price of white and with start up cost of + € 200 net

GROUP	TYPE	DESCRIPTION	LENGTH	ARTICLE NUMBER				UN.	PRICE / UNIT	
L	SIDE RAFTERS		M	O	W 9010	B 8019	RAL		O	W/B
	LT32	Alu side profile for sheets > 25mm	2.5	15548	15556			m	€ 16.79	€ 18.58
			3	15549	15557			m		
			3.5	15550	15558			m		
			4	15551	15569			m		
			5	15552	15570			m		
			7	15555	15572			m		
				TPGL	PVC thermal side rafter profile for glass	4.2		25059		
5.2		25060						m		
6.2		25061						m		
7.2		25062						m		
	TPHL	Alu side support for TPGL	4.1	24992	25004	24996	25008	m	€ 6.53	€ 9.87
			5.1	24993	25005	24997	25009	m		
			6.1	24994	25006	24998	25010	m		
			7.1	24995	25007	24999	25011	m		

GROUP	TYPE	DESCRIPTION	LENGTH	ARTICLE NUMBER				UN.	PRICE / UNIT	
Y	RISING PROFILES		M	O	W 9010	B 8019	RAL		O	W/B
	Y10	Alu adapter profile for 10mm sheets. Slides in the profiles in place of rubber C3 of C8	6.5	18324	18403	18402	21283	m	€ 3.14	€ 5.69
			Y32	Alu adapter profile for 32mm sheets	7	13314				m

## 2. Rubbers and clip profiles

GROUP	TYPE	DESCRIPTION	LENGTH	ARTICLE NUMBER				UN.	PRICE / UNIT	
C	RUBBERS		M	WHITE	GREY					
	C1CX	Coex rubber anti-elastic for CLM	35	17701	17703			m	€ 4.75	
	C2CX	Coex rubber anti-elastic for profiles T16P - T16.1 - T16.2 - T32.1 - TP - TPG - TPGL - Y25 - Y32 - LT16 - LT32	2 x 24	18316	18315			m	€ 6.19	
			35	15471	17697			m		
			50	15472	17698			m		
	C4CX	Coex rubber anti-elastic for wall profile M16 - M32T and side profile L16 - L32.1	2 x 18	18361	18318			m	€ 5.70	
			35	15473	17699			m		
			75	15475	17700			m		
	C12	Support thread for C1CX	200		23875			m	€ 0.78	
	C3	Supporting rubber for sheets for T16.1 - T16.2 - T32.1 - L16 - L32.1 - LT16 - LT32	200		13319			m	€ 1.11	
	C13	Supporting rubber for glass	200		24328			m	€ 4.87	
	C6	Sealing rubber between wooden frame at gutter side and sheets or glass	150		13326			m	€ 5.54	
	C7	Rubber black for WB -10mm	100			65895		m	€ 2.79	
	C8	Sealing rubber for alu clips CL16/32, CLL, CLSB	300		13328			m	€ 1.48	
		Sealing rubber for WB - 10mm	300			23803		m	€ 1.48	
	CY10	Rubber adapter for alu clips CL16 / CL32 / CLL / CLSB / T32.1 / L16 / LT16 / L32 / LT32	50		29509			m	€ 4.20	
	C11CX	Sealing rubber white-black for gutter G Use with Y16P	50	21557				m	€ 9.46	
	C17	Rubber black for WC -10mm	500			72045		m	€ 2.87	



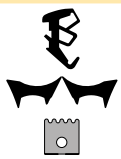

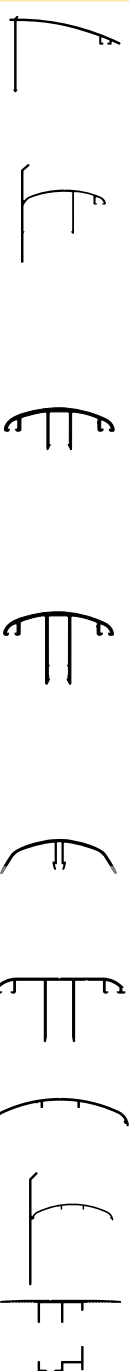





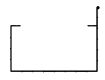
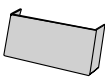



FINISH | O : mill finished aluminium / W : white or RAL 9010 / B : brown or RAL 8019 in stock  
RAL colour cost possible for order Color-Therm Glass : +15% on price of white and with start up cost of + € 200 net

GROUP	TYPE	DESCRIPTION	LENGTH	ARTICLE NUMBER				UN.	PRICE / UNIT	
<b>C</b> 	<b>RUBBERS</b>		<b>M</b>	<b>WHITE</b>	<b>GREY</b>					
	C18	Rubber black for WC -16mm	50			72044		m	€ 2.45	
	C27	Rubber black for WU / WH -10mm	50			72135		m	€ 3.72	
	C31	Supporting rubber for glass with MP and TPHL	200		28805			m	€ 4.87	

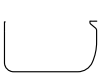
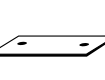
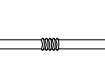
GROUP	TYPE	DESCRIPTION	LENGTH	ARTICLE NUMBER					UN.	PRICE / UNIT	
<b>CL</b> 	<b>CLIP PROFILES</b>		<b>M</b>	<b>0</b>	<b>W 9010</b>	<b>B 8019</b>	<b>A 7016 ST</b>	<b>RAL</b>		<b>0</b>	<b>W/B/A</b>
	CLM	Alu clips profile for wall profile with 16, 25 and 32mm sheets For use with MP, C1CX and C12	3.5 5 7	17707 17710 17711	17724 17725 17726	17721 17722 17723	54973 54974 54975	24375 24376 24378	m m m	€ 16.45	€ 18.91
	CLL	Alu clip profile for side finish with 16, 25 and 32mm sheets Use with LP, TP, TPGL and rubber C8 or CY10	2 2.5 3 3.5 4 5 6 7	17713 17714 17715 17716 17717 17718 17712 17719	17740 17741 17742 17743 17744 17745 17728 17746	17732 17733 17734 17735 17736 17737 17738 17739	31354 31355 31356 31357 31358 31359 31360 31361	21174 21175 21176 21177 21178 21179 21180 21181	m m m m m m m m	€ 20.72	€ 23.82
	CL16	Alu clip profile, use with C8 or CY10 on T16P - TP - TPG In combination with 16mm sheets	2 2.5 3 3.5 4 5 6 7	13329 13330 13331 13332 13333 13824 13334 13335	13336 13337 13338 13339 13340 13928 13341 13342	13343 13344 13345 13346 13347 13927 13348 13349	31234 31235 31236 31237 31238 31239 31240 31241	16063 16064 16065 16066 16067 16070 16071 16072	m m m m m m m m	€ 11.71	€ 13.47
	CL32	Alu clip profile, use with C8 or CY10 on T16P - TP - TPG In combination with 25 and 32mm sheets	2 2.5 3 3.5 4 5 6 7	13350 13351 13154 13155 13156 14372 13157 13158	13352 13353 13159 13160 13161 14373 13162 13163	13354 13355 13164 13165 13166 14374 13167 13168	31242 31243 31244 31245 31246 31247 31248 31249	16073 16074 16075 16076 16088 16089 16091 16092	m m m m m m m m	€ 14.89	€ 17.12
	CLPV	PVC shockproof clip with soft sealing borders for T16P - T16.1 - T16.2 - T32.1 - TP - TPG - Y25 - Y32 - LT16 - LT32 length = standard length + 25mm	2.5 3 3.5 4 5 6 7			15608 15636 15611 15613 15614 15615 15616			m m m m m m m	-	€ 4.73
	CLSB	Screwable clip profile bottom, use with CLST - CLSL and C8 - CY10	4 5 6 7	23914 23915 23916 23917					m m m m	€ 8.34	-
	CLST	Screwable clip profile top, use with CLSB	4 5 6 7	23922 23923 23924 23925	23938 23939 23940 23941	24315 24316 24317 24318	31251 31252 31253 31254	23946 23947 23948 23949	m m m m	€ 5.95	€ 6.82
	CLSL	Screwable side clip profile, use with CLSB	4 5 6 7	25012 25013 25014 25015	25024 25025 25026 25027	25016 25017 25018 25019	31286 31287 31288 31289	25028 25029 25030 25031	m m m m	€ 18.84	€ 21.66
	GVT	Top profile for glass connector	2	61297	61300	61299	61298	61301	m	€ 6.11	€ 8.95
	GVB	Bottom profile for glass connector	2	61293	61296	61295	61294	61302	m	€ 6.73	€ 10.45

FINISH | 0 : mill-finished aluminium / W : white or RAL 9010 / B : brown or RAL 8019 / A : anthracite or RAL 7016 structure in stock  
RAL colour cost possible for order Color-Therm Glass : +15% on price of white and with start up cost of + € 200 net

## 3A. Aluminium gutters

GROUP	TYPE	DESCRIPTION	LENGTH	ARTICLE NUMBER					UN.	PRICE / UNIT		
				0	W 9010	B 8019	A 7016ST	RAL		0	W/B/A	
	G120A	Alu gutter G120A	3.5	13283	13294	13297	54976	21160	m	€ 27.48	€ 34.21	
			5	13285	13295	13298	54977	21161	m			
			7	13291	13296	13299	54978	21162	m			
		G120AS	End piece gutter for G120A	pc	21310	13306	13307	47198	21588	pc	€ 3.94	€ 9.07
		GR	Raised profile for gutter G120A or G	3.5	17820	17828	17825	31343	21163	m	€ 21.22	€ 24.42
				5	17819	17830	17826	31344	21164	m		
				7	17821	17831	17827	31345	21165	m		
		GRS1	End piece gutter for GR or G120A	pc	17832	17835	17834	47596	21598	pc	€ 9.61	€ 11.02
		GV	Set for mechanical gutter connection G120A (2 pcs G120AS, 1 pc GB and 10 stainless screws)	pc	17955					pc	€ 21.05	
		G	Alu gutter profile G for Color-Therm Glass	3.5	21385	21391	24320	31214	21394	m	€ 49.78	€ 57.25
				4.25	23388	23391	25270	31215	23390	m		
				5	21386	21392	24321	31216	21395	m		
7				21387	21393	24322	31217	21396	m			
pc				21543	21540	24323	31259	21544	pc	€ 13.97	€ 16.06	
	GAS1	End piece gutter for G + GD	pc	21543	21540	24323	31259	21544	pc	€ 13.97	€ 16.06	
	GRS2	End piece gutter for G + GR	pc	21584	21586	24324	31261	21587	pc	€ 28.03	€ 36.53	
	LOGO	Logo for end piece gutter GAS1 and GRS2	pc	29943					pc	€ 4.34		
	BUGS	Universal outlet	pc	22387	22389	22388	31384	22391	pc	€ 14.1	€ 22.37	
	WUGS	Outlet gutter spout	pc	22392					pc	€ 14.76		
	GI	Connecting piece for gutter G	0.3	27732					pc	€ 27.81		
	9091	Connecting plate for gutter G120A (50 x 13 x 2.5mm)	pc	12368					pc	€ 3.04		
	909	Connecting pins for G or raised profile GR	pc	8434					pc	€ 0.99		
	Y16P	Thermal break in ABS 16mm black - for rubber C11CX with gutter G	1	21528					m	€ 4.54		
			4	21529					m	€ 4.54		
	GC	PVC water outlet + swivel Ø 80 (grey or brown)	pc		13308	13450			pc	€ 12.55		
	GB	Sealing tape gutter connector 350 x 225mm	pc	13309					pc	€ 7.97		
	411	Outlet 3m + socket 5 years colour guarantee	3		10523	10524			m	€ 15.45		
			pc		10526	10527			pc	€ 4.33		
			pc	10532					pc	€ 0.54		
			pc		10528	10529			pc	€ 9.98		
			pc		10530	10531			pc	€ 9.98		
			pc	15180	15181			pc	€ 13.21			

## 3B. Polyester gutters

See price list roof edge trims

FINISH | 0 : mill-finished aluminium / W : white or RAL 9010 / B : brown or RAL 8019 / A : anthracite or RAL 7016 structure in stock  
RAL colour cost possible for order Color-Therm Glass : +15% on price of white and with start up cost of + € 200 net

## 4. Ridge profiles

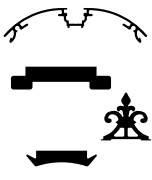
GROUP	TYPE	DESCRIPTION	LENGTH	ARTICLE NUMBER					UN.	PRICE / UNIT	
				M	O	W 9010	B 8019	RAL		O	W/B
	841	Ridge profile Combine with 844, C4CX (2 x), C9 and C10	7.6	17559	17566			17588	m	€ 51.97	€ 56.62
	844	Cover profile ridge (anodised aluminium)	6.5	16793					pc	€ 41.75	
	847	Lily ridge	pc	16803	16805			16807	pc	€ 48.81	€ 84.45
	C9	Rubber for ridge profile 841 (black)	50	16795					m	€ 3.24	
	C10	Rubber flashing 200mm (black)	25	18747					m	€ 5.51	
	846	End piece for ridge profile	pc	16799	16800			16802	pc	€ 33.76	€ 38.82

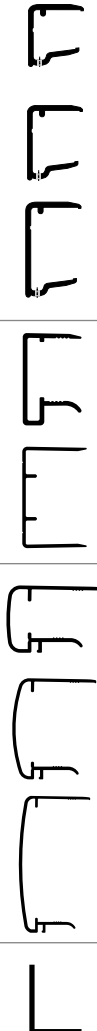

## 5A. Finishing profiles

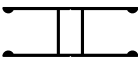

GROUP	TYPE	DESCRIPTION	LENGTH	ARTICLE NUMBER					UN.	PRICE / UNIT		
				M	O	W 9010	B 8019	A 7016ST		RAL	O	W/B/A
	U16P	reinforced PVC end profile for sheets 16mm	0.98		13383					pc	€ 4.82	
			1.053		13384					pc	€ 5.20	
			1.2		13385					pc	€ 5.90	
			1.25		13386					pc	€ 6.19	
			6.4		13396					pc	€ 31.56	
	U25P	reinforced PVC end profile for sheets 25mm	1.2		13397					pc	€ 7.39	
			2.1		35375					pc	€ 12.95	
			5		13441					pc	€ 30.82	
	U32P	reinforced PVC end profile for sheets 32mm	0.98		17874					pc	€ 6.90	
			1.053		27249					pc	€ 7.44	
			1.23		13400					pc	€ 8.48	
			1.25		13401					pc	€ 8.64	
			5		13440					pc	€ 34.48	
	U16A	Alu end profile for sheets 16mm	0.98	13406					17210	pc	€ 5.39	
			1.053	13407					17211	pc	€ 5.84	
1.2			13408					17212	pc	€ 6.62		
6.5			18321					23210	pc	€ 35.83		
U32A	Alu end profile for sheets 32mm	1.23	13469					15917	pc	€ 9.68		
U16	Pre-drilled alu end profile for sheets 16mm	0.98	23553	23569	23557	31183	23565		pc	€ 9.75	€ 12.94	
		1.053	23554	23570	23558	31184	23566		pc	€ 10.45	€ 12.94	
		1.2	23555	23571	23559	31185	23567		pc	€ 11.92	€ 15.45	
		6.1	23556	23572	23560	31186	23568		pc	€ 65.22	€ 85.72	
		0.98	27239	27245	27237	31396	27243		pc	€ 12.35	€ 15.93	
U32	Pre-drilled alu end profile for sheets 32mm	1.23	21534	21552	21546	31195	21555		pc	€ 15.12	€ 19.49	
		5	21535	21553	21547	31196	21556		pc	€ 61.48	€ 79.24	
U55	Pre-drilled alu end profile for sheets 55mm	1.23	69742	69744		69743			pc	€ 18.28	€ 23.38	
L432	L 40/30/2 alu finishing profile for glass 8-34mm thickness	6	23529	23552	24336	31160	23551		m	€ 8.26	€ 9.50	

FINISH | O : mill-finished aluminium / W : white or RAL 9010 / B : brown or RAL 8019 / A : anthracite or RAL 7016 structure in stock  
RAL colour cost possible for order Color-Therm Glass : +15% on price of white and with start up cost of + € 200 net

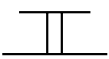





# NON-SELF-SUPPORTING SYSTEMS

GROUP	TYPE	DESCRIPTION	LENGTH	ARTICLE NUMBER				UN.	PRICE/UN.	
U - H	CONNECTION ALU PROFILES		M	0	W 9010	A 7016ST	RAL		0	W/A
	HU	Aluminum corner profile for connection of vertical sheets 16mm	3	46429				m	€ 11.98	
			4	46430				m	€ 11.98	
			7	46431				m	€ 11.98	
	H	Aluminum connection profile for vertical sheets 16mm	1.5	71943	71945	71946	71944	m	€ 12.77	€ 14.69
			3	46426	71948	71949	71947	m	€ 12.77	€ 14.69
			4	46427				m	€ 12.77	
			7	46428				m	€ 12.77	







GROUP	TYPE	DESCRIPTION	LENGTH	THICKN.	ARTICLE NUMBER			UN.	PRICE/UN.	
U - H	POLYCARBONATE PROFILES		M	MM						
	UPH	Transparent polycarbonate connecting profile for vertical sheets (6-10-16mm)	6	6	13435			pc	€ 41.47	
				10	13418			pc	€ 48.61	
				16	13434			pc	€ 72.89	
	UPU	Transparent polycarbonate end profile for 6-10-16mm sheets Not for outdoor use	2.1	6	13438			pc	€ 3.82	
				10	13436			pc	€ 5.81	
				16	13437			pc	€ 8.23	
	UA16	Filling profile for Alltop sheets with sawn borders	3.5	16	12671			pc	€ 35.63	

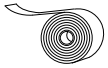

GROUP	TYPE	DESCRIPTION	LENGTH	ARTICLE NUMBER				UN.	PRICE/UN.	
W	PROFILES FOR TRIANGLE AND SIDE WALLS		M	0	W 9010	A 7016ST	RAL		0	W/A
	WB	Base profile for triangle and side wall 42mm for glass 10mm or PC 16mm	5	65849	65852	65851	65850	m	€ 13.18	€ 15.55
			7	65853	65856	65855	65854	m	€ 13.18	€ 15.55
	WC	Clips profile for WB	5	65857	65860	65859	65858	m	€ 4.81	€ 5.98
			7	65861	65864	65863	65862	m	€ 4.81	€ 5.98
	WU	Side profile U for triangle or side wall	1.5	65865	65868	65867	65866	m	€ 6.52	€ 8.14
			3	65869	65872	65871	65870	m	€ 6.52	€ 8.14

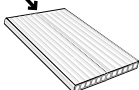

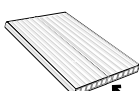
## 5B. Accessories

GROUP	TYPE	DESCRIPTION	QUANT.	ARTICLE NUMBER					UN.	PRICE/UNIT	
S	STOP			0	W 9010	B 8019	A 7016ST	RAL		0	W/B/A
     	S16	Stop for alu profiles	pc	49743	13530				pc	€ 1.77	€ 5.21
	S16C	Esthetic stop for alu profiles with 16mm sheets	pc	15582	15583				pc	€ 3.05	€ 5.40
	S32C	Esthetic stop for alu profiles with 25 and 32mm sheets	pc	15584	15585				pc	€ 3.30	€ 5.90
	S16.3	Stop 3mm for T16P, TP and LP with 16mm sheets	pc	21218	21562	21560	31255	21563	pc	€ 3.19	€ 5.19
	S32.3	Stop 3mm for T16P, TP and LP with 25/32mm sheets	pc	21220	21566	21564	31256	21567	pc	€ 3.34	€ 5.54
	S38.3	Stop 3mm for TPG and TPGL with glass	pc	25079	25082	25080	31257	25083	pc	€ 5.08	€ 5.83

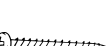
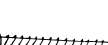
FINISH | 0 : mill-finished aluminium / W : white or RAL 9010 / B : brown or RAL 8019 / A : anthracite or RAL 7016 structure in stock  
RAL colour cost possible for order Color-Therm Glass : +15% on price of white and with start up cost of + € 200 net

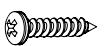
GROUP	TYPE	DESCRIPTION	QUANTITY	ARTICLE NUMBER	UN.	PRICE/UNIT
<b>B</b>	<b>TAPES</b>		<b>ROLL LENGTH (M)</b>			
	BTA	Anti-dust alu tape	50	13369	pc	€ 23.90
	BT16	Closed synthetic tape for 10 and 16mm sheets – With guarantee	10	14408	pc	€ 10.78
			50	14409	pc	€ 31.13
	BT25	Closed synthetic tape for 25mm sheets –With guarantee	10	14411	pc	€ 12.28
			50	14412	pc	€ 36.16
	BT32	Closed synthetic tape for 32mm sheets – With guarantee	10	14413	pc	€ 14.79
			33	82955	pc	€ 27.50
	BT55	Closed synthetic tape for 55mm sheets – With guarantee	33	82956	pc	€ 59.29
			50	60354	pc	€ 97.41
	BB16	Perforated synthetic tape for 16mm sheets – With guarantee	10	13372	pc	€ 20.10
			33	13373	pc	€ 48.20
	BB25	Perforated synthetic tape for 25mm sheets – With guarantee	10	14416	pc	€ 26.63
			33	14424	pc	€ 62.79
	BB32	Perforated synthetic tape for 32mm sheets – With guarantee	10	13374	pc	€ 34.64
			33	13376	pc	€ 82.83
	BB55	Perforated synthetic tape for 55mm sheets – With guarantee	33	60353	pc	€ 143.54
	BM	One-sided adhesive tape 15 x 8mm for sealing between sheets and wall profile M16 / M32B	6	13377	pc	€ 5.54
	BANDV	One-sided adhesive tape 12 x 3-7mm	6	73799	pc	€ 33.03











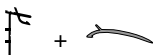
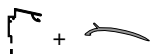

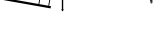
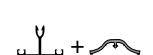
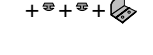
GROUP	TYPE	DESCRIPTION	QUANT.	ARTICLE NUMBER					UN.	PRICE/UNIT	
<b>MT</b>	<b>MOUNTING ACCESSORIES</b>			<b>0</b>	<b>W</b>	<b>B</b>	<b>A</b>	<b>RAL</b>		<b>0</b>	<b>W/B/A</b>
					<b>9010</b>	<b>8019</b>	<b>7016 ST</b>				
	HILO25	Galvanised hilo screw for PVC 5.2 x 25mm for CLSB (set of 25 pcs)	25 pcs	24202					set (25)	€ 6.00	
	HILO40	Galvanised hilo screw for PVC 5.2 x 40mm for CLSB (set of 25 pcs)	25 pcs	24201					set (25)	€ 6.00	
	HILO45	Stainless steel hilo screw for PVC 6 x 45mm for CLSB (set of 25 pcs)	25 pcs	82206					set (25)	€ 11.00	
	ZSC	Stainless steel screw 5.5 x 32 + butyl sealing TX 25 self drilling for TP - TPG	pc	23963					pc	€ 1.17	
	ZSB/G	Stainless steel screw 5.5 x 32 TX 25 self drilling for TP - TPG	pc	20911	18740	18742	31382	21596	pc	€ 0.52	€ 0.67
	PS48	Self drilling stainless Parker screw 4.8 x 25mm for stop	pc	8431	22595	22597	31383	22598	pc	€ 0.50	€ 0.67
	BITS	Torxbit TX25 for stainless steel screw	pc	18744					pc	€ 3.30	
	GATZ	Core drill Ø 80mm	pc	41354					pc	€ 31.86	
	KAL8	PVC buffer for single glazing	pc	27578					pc	€ 0.28	
	KAL20	PVC buffer for double glazing	pc	27331					pc	€ 0.45	
	KAL28	PP buffer 28mm for glazing in profile WB	pc	69951					pc	€ 0.62	

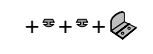
GROUP	TYPE	DESCRIPTION	QUANT.	ARTICLE NUMBER					UN.	PRICE/UNIT	
	<b>MISCELLANEOUS</b>			<b>0</b>	<b>W</b>	<b>B</b>	<b>A</b>	<b>RAL</b>		<b>0/W/B/A</b>	<b>RAL</b>
					<b>9010</b>	<b>8019</b>	<b>7016 ST</b>				
	LAK	Paint brush for repair	pc		24198	33740	31385	24199	pc	€ 12.8	€ 25.50
	SILI	Silicone 310ml for use with PMMA and PC – warranty 10 years with certificate mill-finished & RAL = transparant	pc	15460 (transp)	4736			15460 (transp)	pc	€ 11.38	€ 11.38
	SG20	Silicone glue 310ml for glass connector GVB and GVT (grey)	pc	27494 (grey)					pc	€ 38.45	

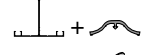
FINISH | 0 : mill-finished aluminium / W : white or RAL 9010 / B : brown or RAL 8019 / A : anthracite or RAL 7016 structure in stock  
RAL colour cost possible for order Color-Therm Glass : +15% on price of white and with start up cost of + € 200 net

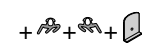
## 6. Prepacked profiles with PE film

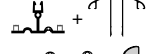
One packing contains: 1 profile + stop profile + matching rubber or clip + label with description and bar code.

GROUP	TYPE	DESCRIPTION	LENGTH	ARTICLE NUMBER			UN.	PRICE/M		PRICE STOP
				O	W 9010	B 8019		O	W/B	stop + screw
	EM16	M16 + C4CX	3.5	13429	15887		pc	€ 22.67 /m	€ 24.91 /m	-
		Set of wall profiles for series ALU / COLOR	5	13431	15741		pc			
	EM32	M32T + M32B + C4CX	3.5	26655			pc	€ 30.56 /m	-	-
		Set of wall profiles for series ALU / COLOR	5	26656			pc			
	EMP	MP + CLM + C1CX + C12	3.5		18186	17947	pc	-	€ 43.09 /m	-
		Set of wall profiles for series COLOR-THERM / COLOR-THERM GLASS	5		17943	18119	pc			
	ET16.1	T16.1 + C2CX (grey) + C3 (2x) + S16C + screw (2x)	2.5	13289			pc	€ 20.73 /m	-	€ 4.86
		Set of rafter profiles for series ALU	3	13300			pc			
	ET16.2	T16.2 + C2CX + C3 (2x) + S16C + screw (2x)	3.5	13302			pc			
		Set of rafter profiles for series ALU / COLOR	4	13303			pc			
	ET32.1	T32.1 + C2CX + C3 (2x) + S32C + screw (2x)	2.5	30993			pc	€ 21.65 /m	-	€ 5.16
		Set of rafter profiles for series ALU / COLOR	3	23577	44834		pc	-	€ 27.59 /m	€ 8.28
	ETP 16	T16P + CL16 + C8 + C8 + S16.3 + screw	3.5	23578	46379		pc			
		Set of rafter profiles for series COLOR-THERM	4	23579	43964		pc			
	ETP 32	T16P + CL32 + C8 + C8 + S32.3 + screw	2.5	27568	43965		pc			
		Set of rafter profiles for series COLOR-THERM	3	31640			pc			
	ETP 16	T16P + CL16 + C8 + C8 + S16.3 + screw	2.5	42877			pc	-	€ 31.74 /m	€ 7.03
		Set of rafter profiles for series COLOR-THERM	3	18408	18165		pc			
	ETP 32	T16P + CL16 + C8 + C8 + S16.3 + screw	3	18100	18988		pc			
		Set of rafter profiles for series COLOR-THERM	3.5	18108	18166		pc			
	ETP 32	T16P + CL16 + C8 + C8 + S16.3 + screw	4	18223	17949		pc			
		Set of rafter profiles for series COLOR-THERM	5	17971	18411		pc			
	ETP 32	T16P + CL16 + C8 + C8 + S16.3 + screw	6	18410	18262		pc			
		Set of rafter profiles for series COLOR-THERM	7	18187	18577		pc			
	ETP 32	T16P + CL16 + C8 + C8 + S16.3 + screw	2.5	18627	18306		pc	-	€ 36.12 /m	€ 7.45
		Set of rafter profiles for series COLOR-THERM	3	18284	18732		pc			
	ETP 32	T16P + CL16 + C8 + C8 + S16.3 + screw	3.5	18188	18120		pc			
		Set of rafter profiles for series COLOR-THERM	4	18027	18333		pc			
	ETP 32	T16P + CL16 + C8 + C8 + S16.3 + screw	5	17945	18388		pc			
		Set of rafter profiles for series COLOR-THERM	6	17946	19025		pc			
	ETP 32	T16P + CL16 + C8 + C8 + S16.3 + screw	7	18107	18189		pc			
		Set of rafter profiles for series COLOR-THERM	7	18107	18189		pc			

FINISH | O : mill finished aluminium / W : white or RAL 9010 / B : brown or RAL 8019

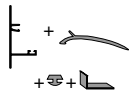
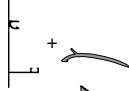
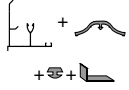
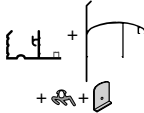
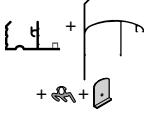

GROUP	TYPE	DESCRIPTION	LENGTH	ARTICLE NUMBER			UN.	PRICE/M		PRICE STOP		
				O	W 9010	B 8019		O	W/B	stop + screw		
E	<b>PREPACKED PROFILES</b>			<b>M</b>	<b>O</b>	<b>W 9010</b>	<b>B 8019</b>		<b>O</b>	<b>W/B</b>	<b>stop + screw</b>	
		EL16	L16 + C4CX (grey) + C3 + S16C + screw (2x)	2.5	13375			pc	€ 19.35 /m	-	€ 4.86	
			Set of side rafter profiles for series ALU	3	13420			pc				
				3.5	13421			pc				
				4	13422			pc				
				4.5	26238			pc				
				5	14629			pc				
				6	13423			pc				
		EL32	L32.1+ C4CX (grey)+ C3 + S32C + screw (2x)	2.5	26632			pc	€ 21.09 /m	-	€ 5.16	
			Set of side rafter profiles for series ALU	3	23580			pc				
				3.5	23581			pc				
				4	23582			pc				
				5	16093			pc				
				6	31641			pc				
				7	35830			pc				
		ELT16	LT16 + C2CX + C3 + S16C + screw (2x)	2.5	22805			pc	€ 25.00 /m	-	€ 4.86	
			Set of side rafter profiles for series COLOR	3	22806	16696		pc				€ 29.06 /m
				3.5	22898	21439		pc				
				4		16579		pc				
				5		16697		pc				
				6	16729			pc				
		ELP 16	LP + CLL + C8 + S16.3 + screw	2.5		18185	18097	pc	-	€ 45.17 /m	€ 7.03	
			Set of side rafter profiles for series COLOR-THERM	3		18103	18178	pc				
				3.5		18109	18098	pc				
				4		18222	17948	pc				
				5		17941	18387	pc				
				6		17942	18263	pc				
				7		18442	18578	pc				
	ELP 32	LP + CLL + C8 + S32.3 + screw	2.5		23953	23629	pc	-	€ 45.17 /m	€ 7.45		
		Set of side rafter profiles for series COLOR-THERM	3		23621	23631	pc					
			3.5		23545	23041	pc					
			4		23262	22941	pc					
			5		23165	22942	pc					
			6		23026	23027	pc					
			7		25552	24658	pc					

Other profiles also available prepacked: price and terms of delivery on request

## Polyclear

### Multi-walled flat polycarbonate sheets

TYPE	STANDARD								X STRUCTURE								NEW		
	6mm ⊗		10mm ⊗			16mm		16mm			16mm				25mm				
THICKNESS (mm)	2W		4W			3W 2uv		3W 16/32mm 2uv			TOP X5		TOP X6		TOP X6		TOP X11		
UV COEXTRUSION																			
WEIGHT (g/m <sup>2</sup> )	1300		1750			2600		4000			2400		2500		3300		3200		
INSULATION VALUE (W/m <sup>2</sup> K)	3.6		2.2			2.2		2.5			2.0		1.9		1.5		1.4		
COLOUR	CLEAR	OPAL	CLEAR/OPAL			CLEAR/OPAL		CLEAR/OPAL			CLEAR/OPAL		CLEAR/OPAL		OPAL	CLEAR	OPAL		
WIDTH mm →	2100	2100	1050	1200	2100	980	1200	980	1200	980	1050	1200	980	1050	2100	2100	1050	1050	
↓ LENGTH mm																			
2000			○	○	○	○				○			○	○	○				
2500			●	●	●	○				○			●	○	●				
2750													●		●				
3000			●	●	●	●	○			●			●	○	●				
3250													●		●				
3500			●	●	●	●	○			●			●	○	●				
3750													●		●				
4000			●	●	●	●	○			●	○		●	○	●				
4250			○										●		●				
4500			●	○	●	○				●			●	○	●				
4750			○																
5000			●	○	●	○				○	○		●	○	●	○			●
6000	●	○	●	○	●	○				○	○		●	●	●	●			●
7000	●	○	●	○	●	○				○	○		●	●	●	●	●		●
7200																			
#/pallet	30	30	50	50	50*	30	30	30	30	30	30	30	30	30	30	20	20	30	



Super insulating

○ While stocks last

⊗ These sheets cannot be used in canopies or veranda roofs; but can be used in barrel vaults and other applications. For more information please call us +32 56 20 00 00 or send us a mail [info@skylux.be](mailto:info@skylux.be)

\* 2100 x 7000mm: 45 pieces/pallet



X STRUCTURE			HEATSTOP <span style="float: right;">NEW</span>										TYPE
32mm			10mm	16mm	16mm				32mm			55mm	THICKNESS (mm)
TOP X6	TOP X11 EP		RELAX	RELAX	REFLEX PEARL	PRIMALITE	REFLEX PEARL EP	PRIMALITE EP	RELAX HX	HEATSTOP			
												UV COEXTRUSION	
3700	3800		1750	2400	2500	2500	3800	3800	3600	5000		WEIGHT (g/m <sup>2</sup> )	
1.4			2.5	2.0	2.1	2.1			1.1	0.8		INSULATION VALUE (W/m <sup>2</sup> K)	
CLEAR/OPAL	CLEAR/OPAL		OPAL	OPAL	OPAL	CLEAR	OPAL	SATIN <sup>■</sup>	CLEAR	OPAL	OPAL	COLOUR	
980 1230	980 1230		1050	980	980 1200	980 1200	980 1230	980 1230 1230	980 1230	1230	980 1230	1230	← WIDTH mm ↓ LENGTH mm
○ ○ ○					○ ○		○						2000
● ● ●				○	● ●	●	●	● ● ●	●	●	●	●	2500
○ ○ ○													2750
● ● ●			●	○	● ●	● ●	● ●	● ● ●	● ● ●	● ● ●	● ● ●	● ● ●	3000
● ● ●											● ● ●		3250
● ● ●			●	○	● ●	● ●	● ●	● ● ●	● ● ●	● ● ●	● ● ●	● ● ●	3500
● ● ○											● ● ●		3750
● ● ●				○	● ●	● ●	● ●	● ● ●	● ● ●	● ● ●	● ● ●	● ● ●	4000
● ● ○			●										4250
● ● ●				○	● ●	● ●	● ●	● ● ●	● ● ●	● ● ●	● ● ●	● ● ●	4500
													4750
● ● ●			●	○	● ●	● ●	● ●	● ● ●	● ● ●	● ● ●	● ● ●	● ● ●	5000
● ● ●				○	● ●	● ●	○ ●	● ● ●	● ● ●	● ● ●	● ● ●	● ● ●	6000
○ ● ●				○	● ●	● ●	● ●	● ● ●	○ ● ●	○ ● ●	○ ● ●	● ● ●	7000
			●										7200
15 15 20			50	30	30 30	30 30	20	20 20	20	20	20	10	#/pallet

■ Opal with satin finish

- Prices, quantity and delivery time for cut-to-size sheets, colours and special executions are on request
- For lengths > 7m and min 500kg: price on request
- Cut-to-size is possible
- Tolerance on sizes: see technical file

## PLEXIGLAS®

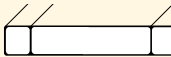
Multi-walled flat acrylic sheets

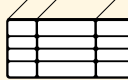
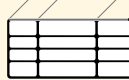
TYPE	STANDARD						HEATSTOP
	16mm				32mm		32mm
THICKNESS (mm)	S2P RESIST AAA				S2A ALLTOP	S5P RESIST	S5P RESIST
CELLS (Th / W)	16/64mm				16/64mm	32/32mm	32/32mm
PROFILE							
Weight (g/m <sup>2</sup> )	4300				5000	5800	5800
U value (W/m <sup>2</sup> K)	2.5				2.5	1.5	1.5
COLOUR	CLEAR (1)		OPAL (1)		CLEAR (2)	OPAL (1)	OPAL (1) (3)
WIDTH mm →	980	1200	980	1200	980	1230	1230
↓ LENGTH mm							
3000	●	○	●	●	●	●	●
3500	○	○	●	●	●	●	●
4000	●	○	●	●	●	●	●
4500	○	○	○	○	○		○
7000	●	○	●	○	●	●	●

- RESIST = improved shock resistance
- AAA = with anti-algae treatment
- (1) NO DROP = coating on one side against condensation
- (2) NO DROP = coating on two sides against condensation
- (3) HEATSTOP = infrared reflective

○ : while stocks last

The sheets are produced on the basis of ISO 9002 according to the ISO 12017 norm with raw materials according to DIN 8745.

Tolerance in sizes: see technical file

### SPECIAL SIZES:

Special sizes (to max 7000mm) can be obtained per pallet order at the price of standard lengths (delivery time will be confirmed).

If less than 10 pieces: quantity charge

CUT-TO-SIZE IS POSSIBLE

(We deliver the offcuts if needed)

# Pergotop – Pergotop-Soft

## Sandwich panels

TYPE	PERGOTOP							PERGOTOP-SOFT
	STANDARD			ACOUSTIC				ACOUSTIC
SHEET THICKNESS (mm)	16mm	16mm	32mm	32mm		57mm		32mm
WEIGHT (kg/m <sup>2</sup> )	5.30	4.85	5.35	5.75		6.50		5.75
U VALUE (W/m <sup>2</sup> K)	2.40	2.07	0.96	0.96		0.48		0.80
COLOUR	grey/grey	white/white*	white/white*	white/white* slate/white*	tile/white*	white/white* slate/white*	tile/white*	white UV/white* slate UV/white* brown UV/white*
SURFACE	2 x alu	2 x alu	2 x alu	2 x alu	2 x alu	2 x alu	2 x alu	1 x soft 1 x alu
WIDTH mm →								
↓ LENGTH mm	1200	1200	1230	1230	1230	1230	1230	1230
2500	●	●	●	●	○	○	○	○
3000		●	●	●	●	●	○	●
3250	●							
3500		●	●	●	●	●		●
4000		●	●	●	●	●	○	●
4500		●	●	●	●	●	○	●
5000		●	●	●	○	○		●
6000		●	○	●	○	●		●
7000		●	○	●	●	○	○	○
#/pallet	50	30	20	20	20	20	20	20

± 1.5mm tolerance on thickness

alu = laquered aluminium / soft = acoustic soft layer

○ : while stocks last

\* Pergotop & Pergotop-soft has a white scratchproof inner side

cut-to-size: is possible

# Demo material

Art.n°	Description	Price (net)
① 28990	Pergolux Color-Therm on pedestal + LED	€ 200
② 27613	Pergolux Alu on pedestal + LED	€ 200
③ 26207	Pergolux case	€ 80
④ 26208	Pergolux D-series case	€ 80
⑤ 18716	Pergolux Alu display model	€ 110
⑥ 18719	Pergolux Color-Therm display model	€ 110
⑦ 25096	Pergolux Color-Therm Glass display model	€ 110
⑧ 78687	Climalux Horizon display model	€ 350
⑨ 30242	Climax Panorama + LED on pedestal	€ 350
⑩ 27612	Climax + LED on pedestal	€ 350
⑪ 35726	Climalux + LED on pedestal	€ 350
⑫ 30625	Climax Panorama case	€ 75
⑬ 21834	Climax case	€ 75
⑭ 35566	Climalux case	€ 75
⑮ 79079	Climalux Horizon case	€ 75
⑯ 26210	Polyclear case	€ 75
⑰ 41664	Climax Panorama GDG + static	€ 75
⑱ 46155	Climaled display model	€ 30
⑲ 51090	Veranda accessories case	€ 75
⑳ 62185	Roll Up Banner Climax/Climalux (EN)	on request
㉑ 61552	Display veranda showroom	€ 300







**info@skylux.be**  
**www.skylux.eu**