



EN

Pergolux[®]

Mounting instructions

Art.N° 41285

SKYLUX
Hello daylight!

Contents

CONTENTS	p. 2
BASIC PRINCIPLES	p. 2
PREPARATION & SPECIAL INSTALLATION INSTRUCTIONS	p. 2
STANDARD TYPES	p. 3
SPECIFIC INSTALLATION INSTRUCTIONS PER TYPE	p. 6
INSTALLATION INSTRUCTIONS FOR MULTI-WALLED SYNTHETIC SHEETS	p. 8
GLAZING THICKNESSES	p. 10

Basic principles

Sheet types

Pergolux has been developed for synthetic multiwalled sheets and for glazing (Color-Therm-Glass). You will find a survey of the different applications and glazing thicknesses on page 10.

Preparation & special installation instructions

Please take into account that the 5 presented standard types have specific differences in installation. You will find these differences in the installation instructions on page 6 and 7.

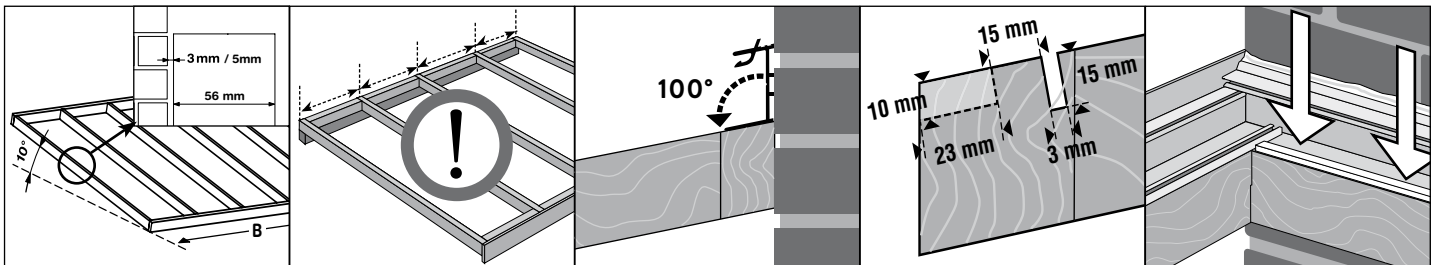

1. Build a timber support structure under an angle of 10° (174 mm / m). If the roof is built against a lateral wall, you must foresee a margin space of 3 mm. For applications with glazing, a 5 mm margin space is needed.

2. Determine the in-between-axis-distances between the rafters according to the glazing and the chosen type (see page 4). In case of glazing use, one should respect

3. See to it, that the top of the timber beam is bevelled under an angle of 10°.

4. The gutter beam should come over the full length of a groove of 3 x 15 mm. For applications with double glazing, 2 parallel grooves with a in-between-distance of 15 mm are needed.

5. Put the white self-adhesive polyethyltape on the wall profile (M16 or M32B) or apply the C31 rubber in the wall profile (MP) for glazing.

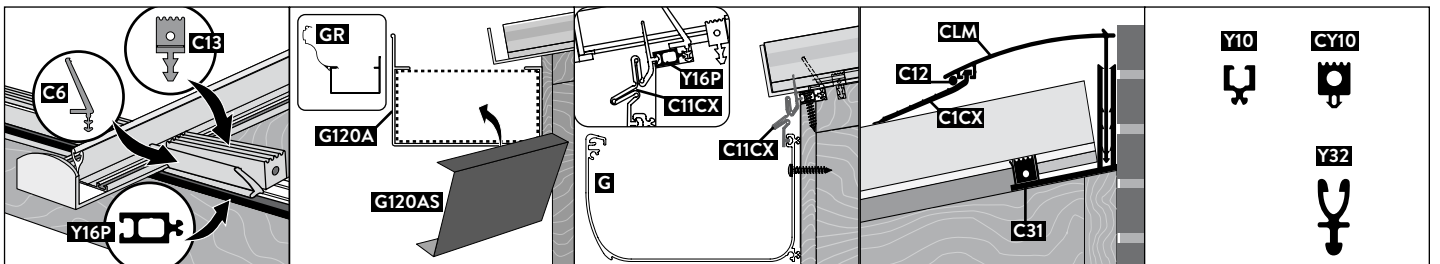

6. Fix the sealing rubber (C6) and, in case of double glazing, the support rubber (C13) in the grooves of the gutter beam.

7. Put the alu gutter G120A against the gutter board and seal the end pieces with silicone. When you use the gutter top piece, screw this every 50 cm and mount the highest side against the gutter beam.

8. Place the alu gutter G against the gutter board and seal the end pieces with silicone. Fix the rubber C11CX between the gutter and the Y16P profile.

9. Fix the rubber C12 between the wall clip CLM and the C1CX rubber to enhance the pressure on the sheets.

10. Put the Y10/Y32 profiles or raised rubber CY10 in the rafters in function of the glazing thicknesses. See page 10.

Standard types

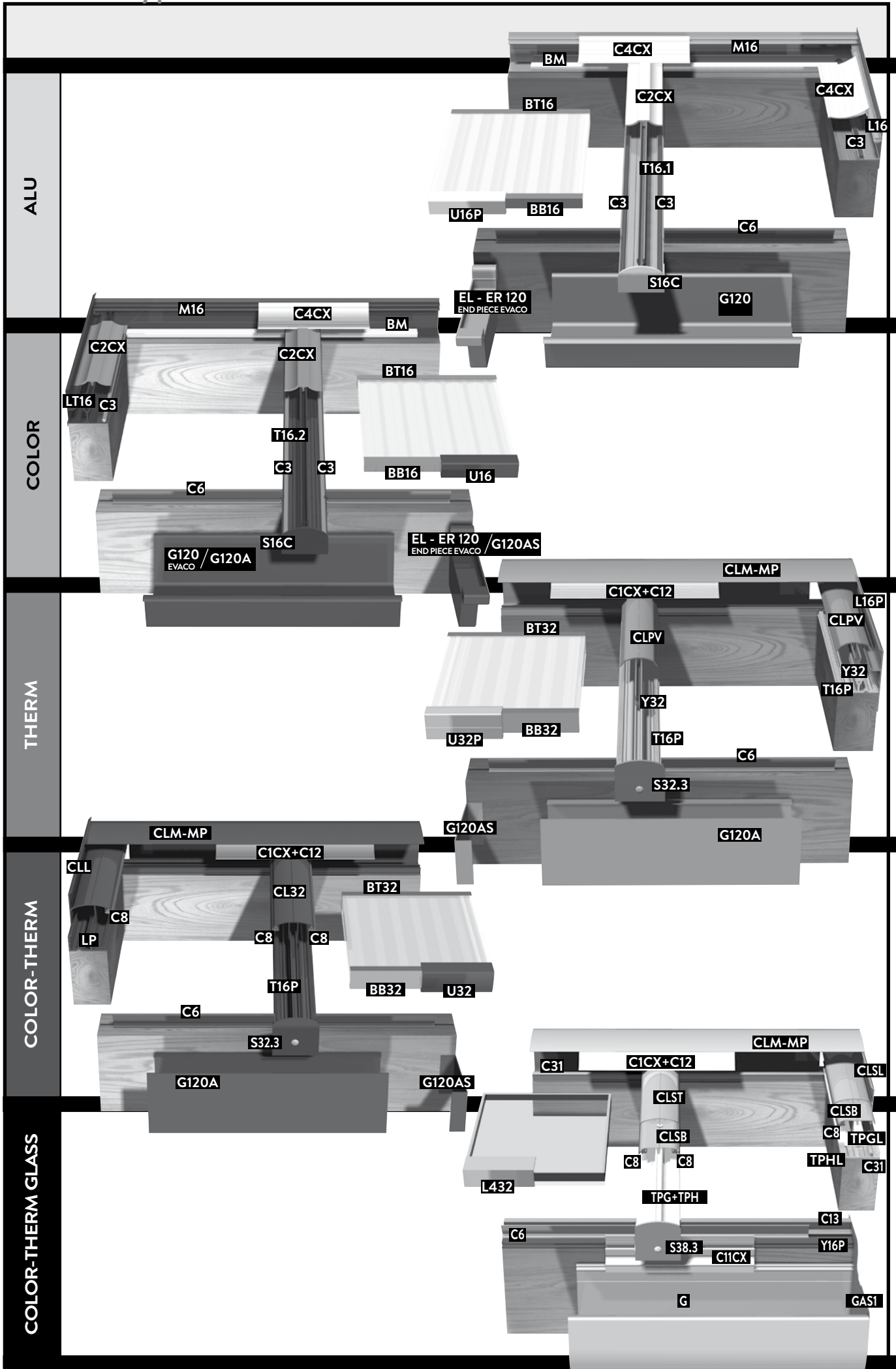

ALU

ALU:
System with aluminium profiles and standard grey coex rubber

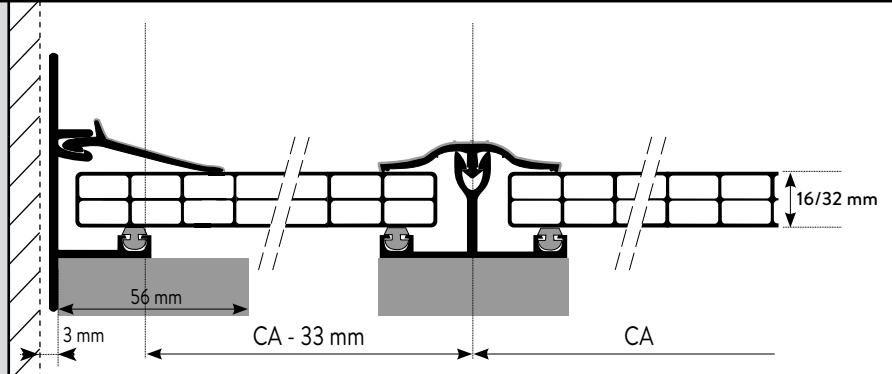

COLOR

COLOR:
System with powdercoated aluminium profiles (white RAL 9010 and brown RAL 8019) and white coex rubber

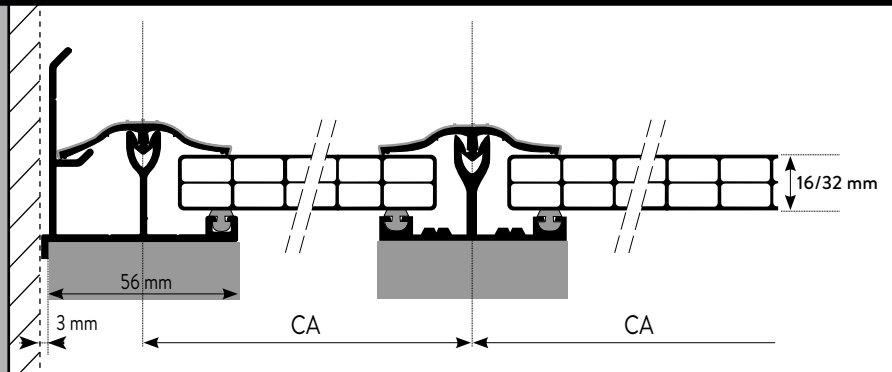

THERM

THERM:
System with thermal rupture and white coextruded PVCu clip

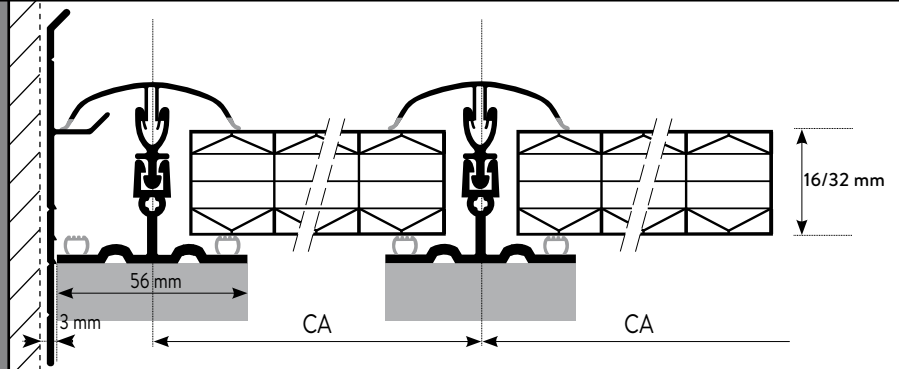

COLOR-THERM

COLOR-THERM:
System with thermal rupture and powdercoated aluminium clip (white RAL 9010, brown RAL 8019 & anthracite RAL 7016ST)

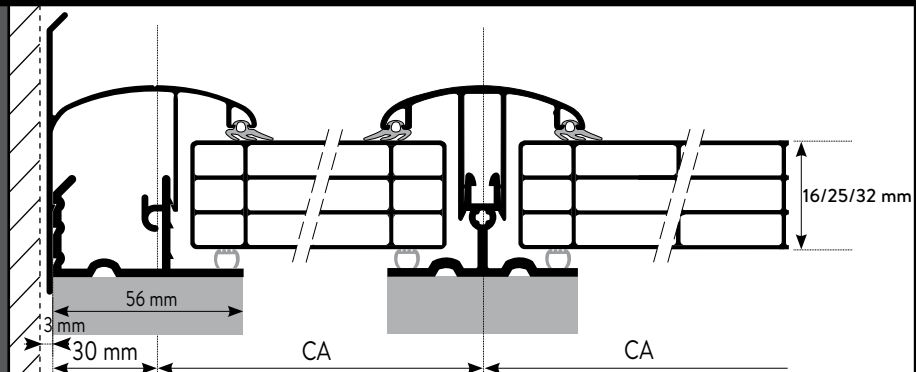

COLOR-THERM GLASS

COLOR-THERM GLASS:
System with thermal rupture and screwable aluminium clip (white RAL 9010, brown RAL 8019, anthracite RAL 7016ST or any other RAL colour of your choice)

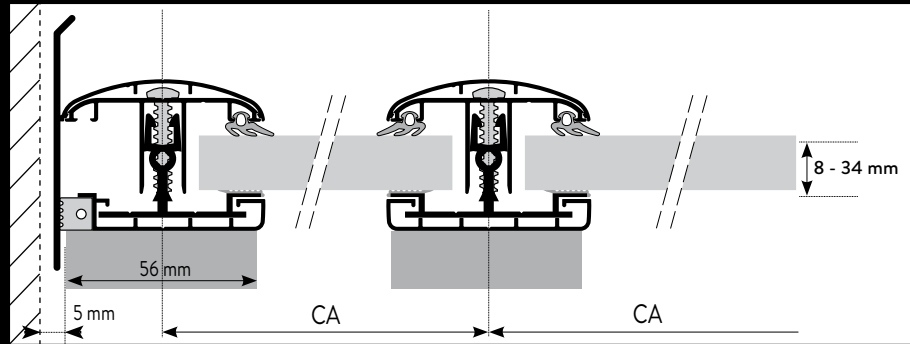

CA = sheet width + 22 mm

	WALL	RAFTER	SIDE RAFTER	GUTTER	ACCESSORIES				
16 MM	M16 + C4CX 	T16.1 + C2CX + C3 (x2) 	L16 + C3 + C4CX 	G120A + G120AS + C6 	S16C	BT16	BB16	U16P	BM
32 MM	M32T + M32B + C4CX 	T32.1 + C2CX + C3 (x2) 	L32.1 + C4CX + C3 	G120A + G120AS + C6 	S32C	BT32	BB32	U32P	BM
16 MM	M16 + C4CX 	T16.2 + C2CX + C3 (x2) 	LT16 + C3 + C2CX 	G120A + G120AS + C6 	S16C	BT16	BB16	U16	BM
32 MM	M32T + M32B + C4CX 	T32.1 + C2CX + C3 (x2) 	LT32 + C2CX + C3 	G120A + G120AS + C6 	S32C	BT32	BB32	U32	BM
16 MM	CLM + MP + C1CX + C12 	T16P + CLPV 	L16P + T16P + CLPV 	G120A + G120AS + C6 	S16.3	BT16	BB16	U16P	
32 MM	CLM + MP + C1CX + C12 	T16P + Y32 + CLPV 	L16P + Y32 + T16P + CLPV 	G120A + G120AS + C6 	S32.3	BT32	BB32	U32P	
16 MM	CLM + MP + C1CX + C12 	T16P + CL16 + C8 (x2) 	CLL + LP + C8 	G120A + G120AS + C6 	S16.3	BT16	BB16	U16	
32 MM	CLM + MP + C1CX + C12 	T16P + CL32 + C8 (x2) 	CLL + LP + C8 	G120A + G120AS + C6 	S32.3	BT32	BB32	U32	
8 MM to 34 MM	CLM + MP + C1CX + C12 + C31 	TPH + TPG + CLSB + CLST + C8 (x2) + screw 	TPHL + TPLG + CLSB + CLSL + C31 + C8 + screw 	G + GAS1 + C6 + C13 + Y16P + C11CX 	S38.3	L432			

* to combine with gutter top piece GR

Specific installation instructions per type

ALU

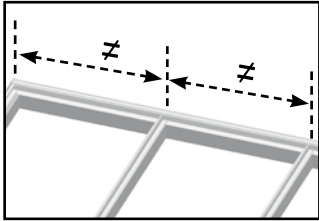

1. Install the wall profile M16 and afterwards the different rafters T16.1. Each time, use the in-between-axis distances (CA) and take the L16 into account (see page 4).

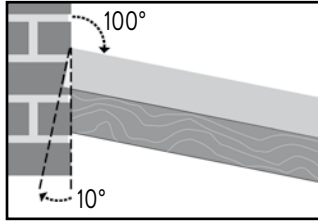

2. Bevel the wall side of profile L16, so that the side joins the wall.

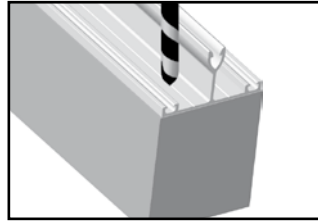

3. Drill and screw every 50 cm in the foreseen groove of the rafter T16.1.

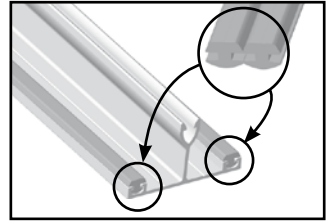

4. Fix the support rubber C3 in the rafters and lateral profiles. The rubber is packed by two and needs to be undo.

COLOR

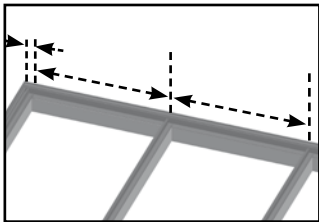

1. Install the wall profile M16 and afterwards the different rafters T16.2. Each time, use the in-between-axis distances (CA) and take the L16 into account (see page 4).

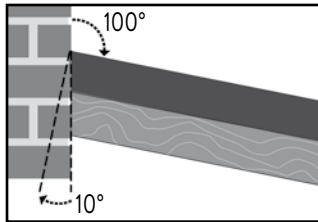

2. Bevel the wall side of profile L16, so that the side joins the wall.

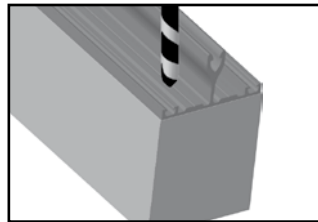

3. Drill and screw every 50 cm in the foreseen groove of the rafter T16.2.

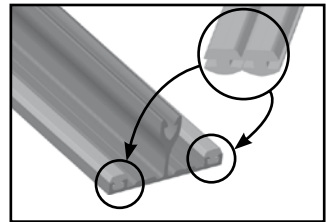

4. Fix the support rubber C3 in the rafters and lateral profiles. The rubber is packed by two and needs to be undo.

THERM

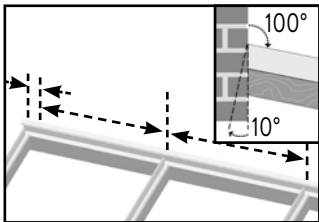

1. You need to take the stated in-between-axis distances CA and the angle 10° into account for the timber support structure (see page 4).

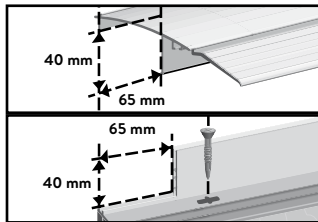

2. Remove 65 mm of the vertical part of the wall profiles MP and CLM on the left and right side. Fix the MP profile in the wall beam through screws with countersunk head. Glide the rubber C1CX in the profile CLM.

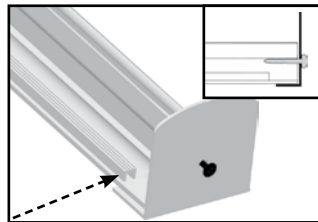

3. Cut off the coex rubber of the T16P over 25 mm at the bottom. Fix the stop profile S16.3/S32.3 with the stainless steel screw to the end of the T16P profile.

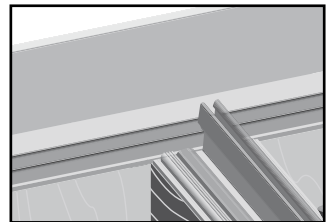

4. Install the T16P profiles against the MP profile. Fix them with screws with countersunk head through the foreseen groove holes.

COLOR-THERM

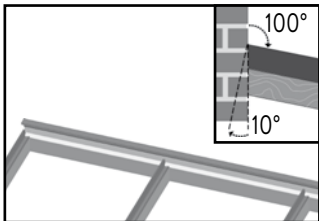

1. You need to take the stated in-between-axis distances CA and the angle 10° into account for the timber support structure (see page 4).

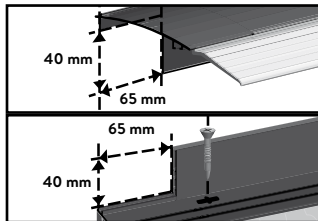

2. Remove left and right 65 mm of the vertical part of the wall profiles MP and CLM. Fix the MP profile in the wall beam through screws with countersunk head. Glide the rubber C1CX in the profile CLM.

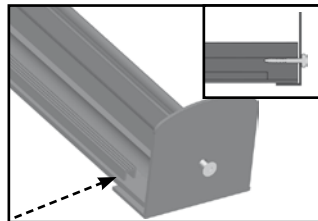

3. Cut off the coex rubber of the T16P and the LP over 25 mm at the bottom. Fix the stop profile S16.3/S32.3 with the stainless steel screw to these profiles.

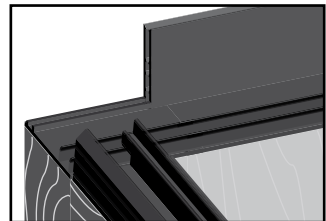

4. Install the T16P and LP profiles against the MP profile. Fix them with screws with countersunk head through the foreseen groove holes.

COLOR-THERM GLASS

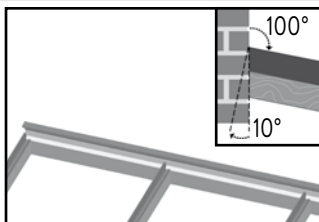

1. You need to take the stated in-between-axis distances CA and the angle 10° into account for the timber support structure (see page 4).

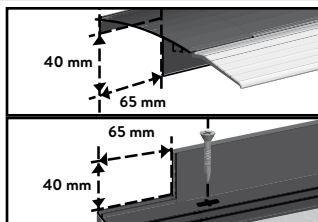

2. Remove left and right 65 mm of the vertical part of the wall profiles MP and CLM. Fix the MP profile in the wall beam through screws with countersunk head. Glide the rubber C1CX in the profile CLM.

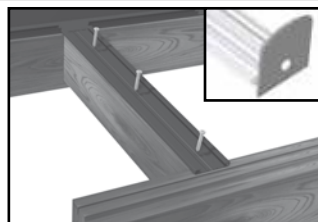

3. Lay the alu profiles TPH and TPHL against the MP and screw every 50 cm on the timber beams. Fix the stop profile S38.3 to the punched side of the glass rafters TPG and TPGL.

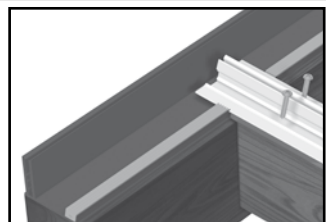

4. Adapt the glass rafters TPG and TPGL to size and glide them in the aluminium profiles against the wall profile MP and screw with 2 screws on the upper side. Fix the rubber C31 in the wall profile MP.

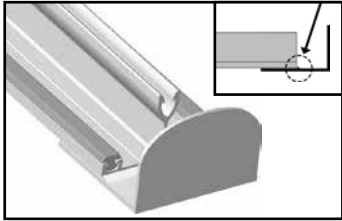

5. Fix the stop profile S16C against the bench edge of the extremities of all rafters (T16.1).

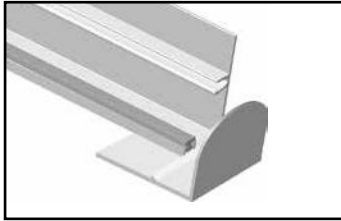

6. Fix the stop profile in the same way to the extremity of the lateral rafter L16.

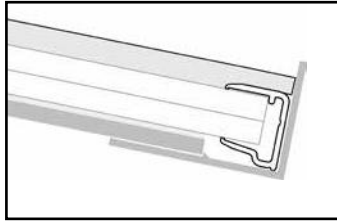

7. The C2CX rubber provides the sealing of the sheets. Push up the C2CX rubber as far as possible before cutting it off at a length slightly longer than the S16C profile. At the top, the C2CX rubber comes underneath the C4CX rubber.

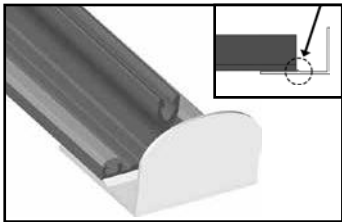

5. Fix the stop profile S16C against the bench edge of the extremities of all rafters (T16.2).

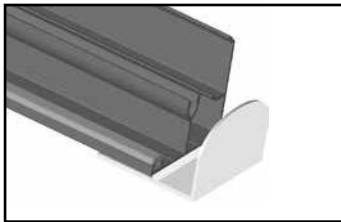

6. Fix the stop profile in the same way to the extremity of the side rafter LT16.

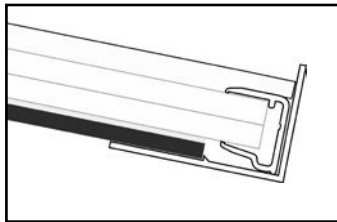

7. The C2CX rubber provides the sealing of the sheets. Push up the C2CX rubber as far as possible before cutting it off at a length slightly longer than the S16C profile. At the top, the C2CX rubber comes underneath the C4CX rubber.

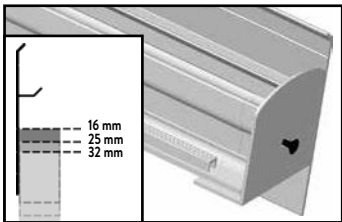

5. The extremity of the L16P profile comes at the same position of the front side of the stop profile. Fix the L16P in function of the sheet thickness.

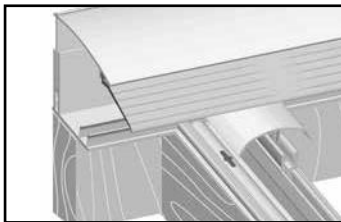

6. Finish with the CLPV clips and put the CLM in the MP profile.

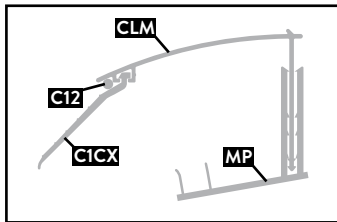

7. Cut into the C1CX rubber next to the clips till the 4th lign and cut off (ca 55mm x 20 mm). Push at sheet height the extremity of the rubber under the wall clips profile CLM.

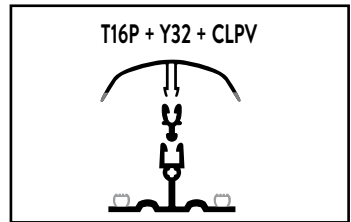

8. For applications with 32 mm sheets, please use the Y32 raising profile (see page 10).

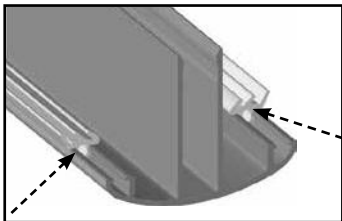

5. Fix the C8 rubber in the clips profiles CL16/32 and CLL at 25 mm from the bottom to leave some space for the sheet sealing profile. Fix the clips CL16/32.

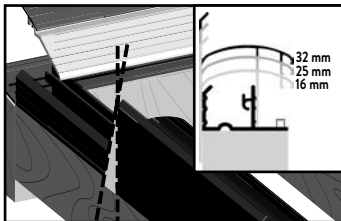

6. Clips the CLM in the MP profile. Glide the CLL profiles underneath the wall rubber and clips on the side rafters. Install the CLL in function of the sheet thickness.

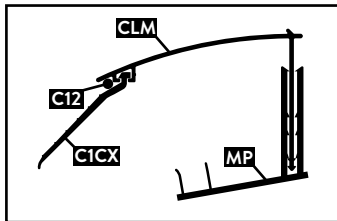

7. Cut into the C1CX rubber next to the clips till the 4th lign and cut off (ca 60mm x 20 mm). Push at sheet height the extremity of the rubber under the wall clips profile CLM.

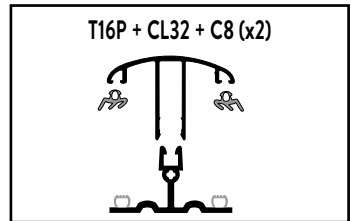

8. For applications with 25 mm sheets, please use the CL32 (see page 10).

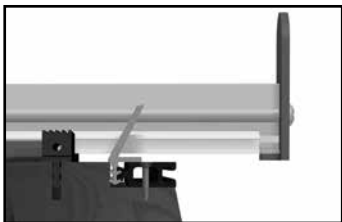

5. Put the C6 and C13 rubber in the 2 grooves of the gutter beams between the rafters. Screw also the Y16P profile between the rafters on the gutter beam.

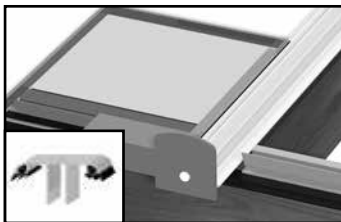

6. Fix the glazing and put the L432 on the front side of the glazing. Put the rubber C8 into the screwable clips CLSB. The CY10/Y10/U25 profile can be used in function of the glazing thickness.

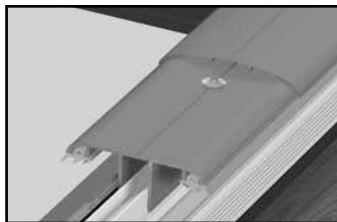

7. Screw the clips CLSB on the rafters for glass and install the clips CLST/CLSL.

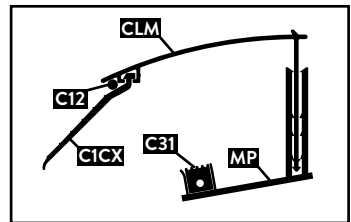

8. Push down the wall clips CLM with rubber C1CX into the wall profile MP. Install afterwards the round rubber C12 between the CLM and the C1CX rubber to increase pressure of the rubber on the sheets.

Installation instructions for multi-walled polycarbonate, acrylic synthetic sheets and sandwich panels

You just bought a high-quality synthetic sheet.

To avoid problems during its installation, please follow these installation instructions thoroughly.

May we ask you to have special attention for: expansion space/silicone and timber protectors/rubber.

1. MARGIN SPACE

Synthetic sheets shrink and extend under the influence of temperature fluctuations. Please take next tips into consideration:

- You must foresee 5 mm play per meter sheet length and 10 mm play in the width (5 mm per side), e.g: a sheet of 3000 mm needs a margin of 1,5 cm in the length.

- Never block the sheet in the width or the length. Sufficient margin is needed.

- Never stick the sheet into silicone (even synthetic friendly silicone). You would prevent the shrinking and the dilatation of the sheet.

- As the sheet is stopped at the bottom against gliding, you must foresee all margin space at the top.

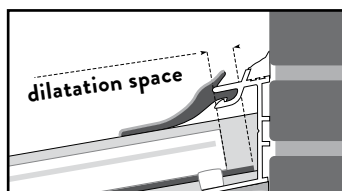
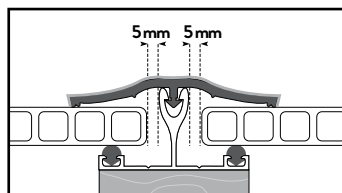

2. SILICONES, RUBBER AND TIMBER PROTECTORS

- Almost all silicones affect the acrylic or polycarbonate. Ask for the silicone types approved for use with acrylic and polycarbonate (proof of guarantee).

- The vapours of these kits must never come into the canals of the sheet. The ventilation holes and the sides of the obturator profiles cannot be sealed. The silicone must always evaporate freely.

- Some sealings contain softening agents (as used in some rubber, PVCu, polyurethane), which cause little splits. Only use approved sealings.

- Never use black or darkcoloured rubber to prevent from heat accumulation.

- A lead flashing may rest on the rubber but never on the sheets.

- Some paints, varnishes and timber protectors affect the acrylic and polycarbonate.

- Never spray insecticides on the sheets. This could affect the sheets.

3. MAINTENANCE

- Clean the sheets annually with tepid rainwater. You can add some non aggressive household soap (no detergent!) Never use any solvents or abrasives.

- Never rub dry (scratches)

- Only rinse off.

4. INSTALLATION

- Make sure you consider the safety instructions about working on roofs.

Polycarbonate sheets : very important! These sheets must always be installed with the UV protected side turned to the outside/top. This "sunsides" is specially marked on the protection film.

- The synthetic adhesive tape or the temporary aluminium tape only keeps the sheets dustfree during transport. It must definitely be taken off! It is necessary to use adapted aluminium tapes and/or obturators. (See point 6 page 9).

- The support construction must be solid and stable (consult the instructions for the timber and metal construction). In function of the type of sheet, transversal supports can be needed. Take the respective charges 500 N/m² or 750 N/m² into consideration to use certain maximum lengths without transversal support according to the type of sheet (See table page 10).

- Warmth-accumulation: the upper side of the support structure, turned to the sheets, must be WHITE reflective.

- For this, use white dispersion paint (dilute in water or paint without solvent) or use preferably aluminium tape. Attention: after having paint the support construction, it must dry! Only install the sheets afterwards. NEVER install the synthetic sheets directly on the timber.

- Roof tiles must not rest on the sheets! There must be at least 10 mm space between the sheets and the roof covering.

- To seal the opening between the sheet and the gutter beam, use a special weather strip (sealing rubber C6). (See page 2 fig. 6). Do not spout or fill with PU foam.

- We firmly advise against installing underceilings underneath the acrylic (PMMA) sheets. If sunblinds or other accessories are installed, make sure you install these 120 mm from the sheet. The accessories cannot be insulated and are preferably reflective. There are no specific precautions for polycarbonate sheets.

- WIDTH DIVISION OF THE SHEETS:

WE RECOMMEND: standard sheet width and a adapted piece for the two outer sheets. This must certainly be done with the SSP Heatstop sheets.

The closed sides also determine the mechanic strength of the sheet!

WE STRONGLY ADVISE

AGAINST: sawing the sheets in equal parts (in the width) Take the standard sheet width into account.

5. GLASS

- For applications with glass, you always need to follow the instructions of the glass producer !

The installation instructions are only of advisory and informative nature. The installation is the sole responsibility of the customer. THE RESPONSIBILITY OF THE PUBLISHER TOWARDS THE INSTALLATION IS EXPLICITLY DECLINED. PERGOLUX - SKYLUX - CLIMAX - CLIMALITE - REFLEX PEARL - RELAX - PRIMALITE - POLYCLEAR ARE REGISTERED TRADEMARKS OF SKYLUX

6. DRAINAGE AND CONDENSATION

Dust and damp may not enter into the cell structure:

- A combination of BT 16/25/32 at the top and BB 16/25/32 with U16/25/32P at the bottom, stops dust of > 50µm from entering the cell structure.

- The underside is provided with a perforated aluminium filter tape. To protect the tape, use the U16P/U25P/U32P or a U profile with perforations of Ø 3.5 mm, installed every 20 cm.

- Seal the profile with synthetic friendly silicone to prevent water infiltration maximally.

- Wet the edge of sheets with no-drop layer and dry it afterwards before taping the sheet.

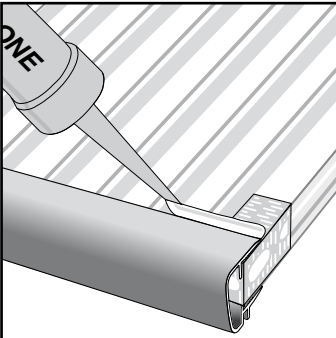
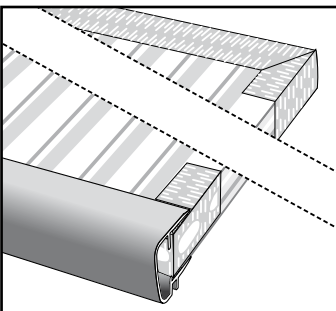

- Make sure that the bottom NEVER stands in water (moss and algae).

- Condensation in the canals is not 100% inevitable (physical phenomenon).

Acrylic and polycarbonate are very less gas- and dampproof. The characteristics of the material and the guarantee are not diminished because of this. An appropriate sealing is recommended.

7. SHEET DIRECTION

- Install the sheets with inclination or vertically, never horizontally (unless interior use).

- Minimum inclination: 10° (18 cm per meter) or more.

- The direction of the sheet canals must always go along with the roof inclination.

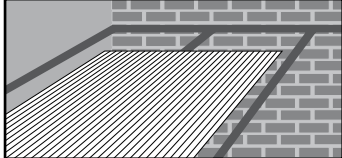

8. REFLECTION

- Multi-walled synthetic sheets may reflect the sunlight to the inside or the outside in case of direct sunlight (following the orientation or the inclination). This is a normal situation which does not affect the sheet guarantee.

9. SAWING AND DRILLING

- Always use a grease pencil to make notes on the protection film (felt pen is difficult to remove)

- To ensure a fast clamping during the sawing, you should always make sure that a raised rib is as near as possible by a sawed edge.

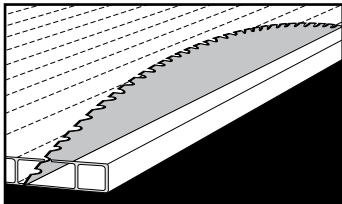

- When sawing, use a hard metal saw (widea) with high rotation speed. Saw slowly and by preference with one move. Use new or sharpened saw blades. Make sure the sides are always smooth.

ATTENTION: The basis on which the sheets are sawn, must be stable and vibration-free. The sheets must not move during sawing. The saw blade must slightly reach out of the sheet.

Type of saw blade:
1. hard metal (for ca 50 m/s)

neutral angle $\alpha = 10^\circ$ up to 15°
chip angle $\gamma = 0^\circ$ up to $+5^\circ$

straight sawteeth

2. HSS (not more than 40 m/s)

neutral angle $\alpha = 30^\circ - 40^\circ$
 $\gamma = 0^\circ$ to -4° (Acrylic)
 $\gamma = 5^\circ$ to -8° (Polycarbonate)

with sawteeth

- Remove all dust and sawing rests from the canals with pure compressed air or a powerful vacuum cleaner.

- Only remove the protection film after installation to avoid scratches.

- Drilling is strongly advised against. However, if unavoidable, provide with grooves (shrinking and dilatation).

10. PILING

- Avoid direct sunlight on piled sheets.

- If you pile the sheets outside, cover the sheets with white polyethyl foil. Always keep the synthetic friendly tape as sealing on the front sides of the sheets.

- The sheets must not be piled directly on the ground. Use appropriate pallet boards.

11. SUN PROTECTION

- If you install sun protection, you must do this on the upper side of the sheets: e.g. on the outside.

Attention:
Do not put the sun protection directly on the sheet!
You can also buy sunproof sheets (PC: Primalite Clear, Reflex Pearl, Relax - PMMA: S5P Heatstop) or install a Skylux conservatory dome.

12. REMEMBER

- Never walk or kneel directly on the sheets. Always use solid timber boards underneath. Make sure these boards are supported by the timber construction.

- Multi-walled synthetic sheets with thin walls and a high insulating structure in the sheet, are sensitive to foot, knee and other impressions at the surface. Please take enough precautions during transport and installation. Impressions in the sheet are not covered by the guarantee.

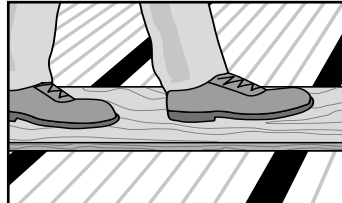

13. SNOW AND SNOW PILE

- The multi-walled synthetic sheets resist normal snow load. You can find the maximum snow load on the technical files per sheet type and size. In case of heavy snow fall, we recommend to regularly clear the snow. The conservatory roof must also be protected against snow falling from a higher situated roof.

14. DILATATION NOISES

- As we already mentioned several times, synthetic sheets shrink and dilate under the influence of temperature fluctuations. When they move with regard to the roof construction, there can be some creak noises. There is no danger for the sheets if they have been installed according to the installation instructions.

- Screwed clips cause more creak noises with synthetic sheets.

- If you would like to avoid crack noises, we advise you to always use the TP and TPH profiles. The TP can expand and shrink with the synthetic sheets or alu sandwich sheets.

15. FURTHER INSTRUCTIONS

- Only use sheets with identic production number per project to avoid colour differences.

- For applications with glass: see Pergolux Glass.

Glazing thicknesses

Thickness	Alu & Color		Therm	Color Therm			Glass		
	T16.1&2/LT16	T32.1 /LT32	T16P	T16P		LP	TPH + TPG		
	C2CX	C2CX	CLPV	CL16	CL32	CLL	CLSB & CLST	CL16	CL32
8 mm	++(Y10)			+°		+°	++ (CY10) °HL25	++ (CY10)	
9 mm	++(Y10)			+°		+°	++ (CY10) °HL40		
10 mm	++(Y10)			+°		+°	++ (CY10) °HL40	+°	
11 mm	+(Y10)			+°		+°	++ (CY10) °HL40	+°	
12 mm				+°		+°	++ (CY10) °HL40	+°	
13 mm			+	+°		+°	++ °HL25	+°	
14 mm			+	+°		+°	++ °HL25	+°	
15 mm	+		+	+°		+°	++ °HL25	+°	
16 mm	++		++	++		++	++ °HL25	++	
17 mm	+		+				++ °HL40	+°	
18 mm	+		+				++ °HL40	+°	
19 mm							++ °HL40	+°	
20 mm							++ °HL40		
21 mm							++ °HL40		
22 mm							++ °HL40		
23 mm							++ °HL40		
24 mm							++ °HL40		
25 mm					++	++	++ °HL40		++
26 mm							++ °HL40		
27 mm							++ °HL40		
28 mm							++ °HL40		
29 mm							++ °HL40		
30 mm			+ (Y32)				++ °HL40		
31 mm		+	+ (Y32)				++ °HL40		
32 mm		++	++ (Y32)		++	++	++ °HL40		++
33 mm		+	+ (Y32)				++ (Y32) * °HL40		
34 mm		+	+ (Y32)				++ (Y32) * °HL40		

The available thicknesses for plastic sheets are 10, 16 and 32 mm.

Legende	
++	ideal solution
+	good solution
°	screw on
Y32	slide Y32 on Tx
Y10	use Y10 on both sides of the T16/T32
CY10	use Y10 on both sides of the CL/CLSB
*	always pre-drill, (Ø drill hole Y < Ø screw)
HL25	Hilo 25
HL40	Hilo 40

your Pergolux dealer :

ONLY USE ORIGINAL PARTS DELIVERED BY AG.PLASTICS. EVERY GUARANTEE IS CANCELLED IF NON-ORIGINAL PARTS ARE USED.

SKYLUX® IS A REGISTERED BRAND OF SKYLUX
 SPINNERIJSTRAAT 100 - B-8530 STASEGEM
 T +32 (0)56 20 00 00 - F +32 (0)56 21 95 99
 INFO@SKYLUX.BE
 WWW.SKYLUX.BE

