



EN

Monoflap - SHE pneumatic - Combi

Mounting instructions

Art.N° 59681

**SKYLUX**[®]
Hello daylight!

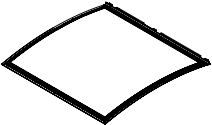
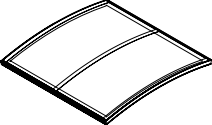
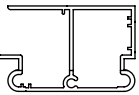

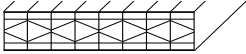
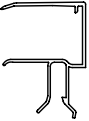



Table of contents











CONTENT	p. 2
TERMS & ABBREVIATIONS	p. 2
PART LIST	p. 3
EXPLODED VIEW	p. 5
PRIOR INSPECTION	p. 5
REQUIRED TOOLS	p. 6
ASSEMBLY SEQUENCE FLAP	p. 7
BARREL VAULT	p. 7
CURVED BARREL VAULT PROFILES	p. 7
CROSSBEAMS	p. 7
ARCH STABILIZERS & SHEETS	p. 9
SHEETS BARREL VAULT	p. 9
FINISH BARREL VAULT	p. 10
BOTTOM FRAME	p. 10
TOP FRAME	p. 12
HINGE PINS & SCREWS	p. 13
ASSEMBLY SEQUENCE MOTOR (TRAVERSE)	p. 14
LOCK	p. 14
TRAVERSE WITH CYLINDER	p. 14
VENTILATION MOTOR (COMBI ONLY)	p. 15
PNEUMATIC CYLINDER	p. 18
CO2 BOTTLE	p. 19
LOCKING PIN ADJUSTMENT	p. 20
ELECTRICAL CONNECTION (COMBI ONLY)	p. 21
MAINTENANCE AND PERIODIC TEST	p. 21
WARNINGS	p. 22
SAFETY DURING ASSEMBLY	p. 22

Terms & abbreviations

SHE Pn: Smoke and Heat Extractor Pneumatic
Combi: SHE Pn combined with electric ventilation motor

Parts list

PART	QUANTITY	REMARK
FLAP		
	1	BOTTOM FRAME
	1	TOP FRAME
	4	CROSSBEAMS to mount between the curved profiles
		SELF-TAPPING SCREWS Ø 5,5 X 38 MM
	6	To fix the hinge on the curved PROFILES
	3	HINGE PINS Ø 10 MM X 195 MM - stainless steel - to connect the bottom and top frame
	6	SCREWS Ø 4,8 X 16 - stainless steel - for blocking the hinge pins
	4	PVC TUBE WHITE 2130 MM 25 MM X 20 MM replacement for the PVC sheets
	4	BOLTS M6 X 70 MM to mount the crossbeams
	*	PC SHEETS included in barrel vault delivery
	*	CLOSURE PROFILE included in barrel vault delivery
	*	BOLTS M8 X 60 MM included in barrel vault delivery
	*	ARCH STABILIZER included in barrel vault delivery
	*	COVER PLATE included in barrel vault delivery

PART	QUANTITY	REMARK
MOTOR		
	1	TRAVERSE WITH PNEUMATIC CYLINDER
	1	VENTILATION MOTOR only for combi version
	12	SELF-TAPPING SCREWS Ø 5.3 X 38MM to mount the traverse on the crossbeams
	1	CO ₂ GAS BOTTLE
	1	CLAMPING BOLT accessory, to mount CO ₂ gas bottle
	1	GLASS BULB
	1	GLASS BULB HOLDER
	4	BOLTS M6 X16 to fix the lock on the bracket
	2	SCREWS FOR VENTILATION MOTOR with counter nut - only for combi version
	2	BOLT AND NUT only for combi version
	1	WIRE BRACKET WITH SPRING only for combi version
	1	LOCKING PIN only for combi version

Exploded view Monoflap

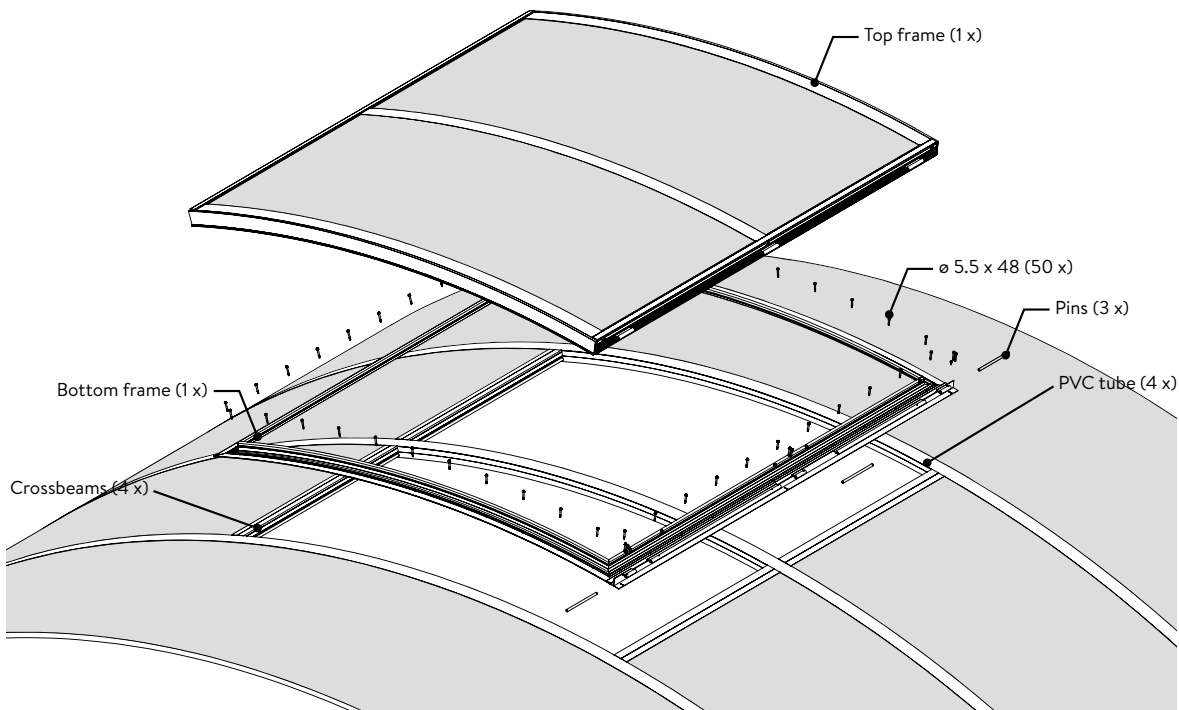

Prior inspection

- **Squareness barrel vault**

Before you mount the single flap, check if the curbs are parallel and if the curved profiles of the barrel vault are mounted perpendicular to the curbs. If the barrel vault is not installed according to the mounting instructions of the barrel vault, it is possible that the single flap cannot be mounted.

It is very important that the difference between the diagonals is not more than 5 mm. Otherwise, the top frame will not fit on top of the bottom frame.

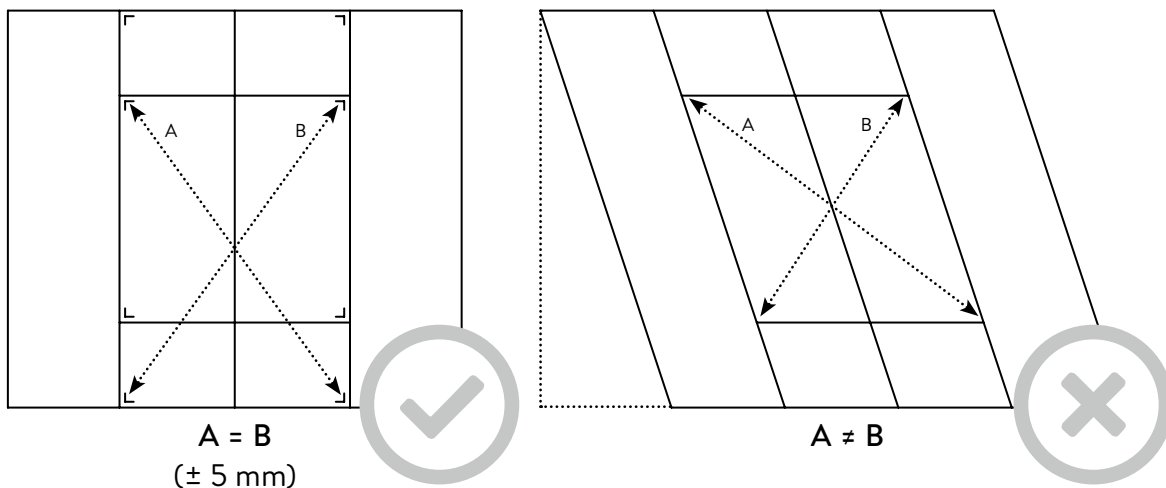

- **Squareness frames**

Before installing the frames, check if the difference between the diagonals is less than 5 mm. Especially the squareness of the bottom frame.

- **Safety nets**

The roof opening must be secured completely with safety nets before starting the installation of barrel vault and flap.

Required tools

- **Aerial work platform**

We advise to use a small one-man aerial work platform as the other installer(s) will be needed on the roof or scaffold.

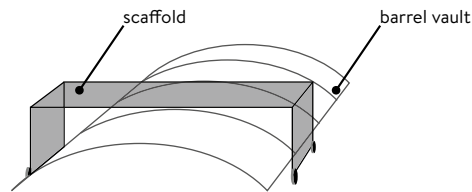
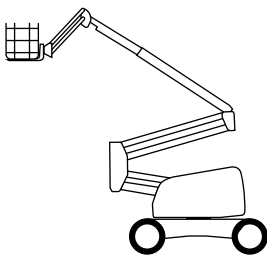

- **Work tools**

- cordless drill with bits 8 and 10

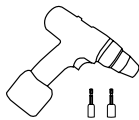

- laser
(or other measuring equipment)

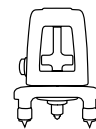

- screwdriver with flat head

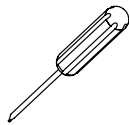

- wrench 12, 13 & 17



- hammer



- Allen key 6

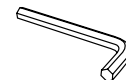

- meter

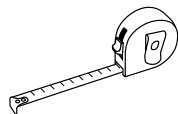

Assembly sequence flap

- **Barrel vault**

Mount the barrel vault until lower curved profiles (LP525) are placed according to the installation manual of the fixed barrel vault.



- **Curved barrel vault profiles (3x)**



Place the curved profiles LP525 with slotted holes according to the picture below.

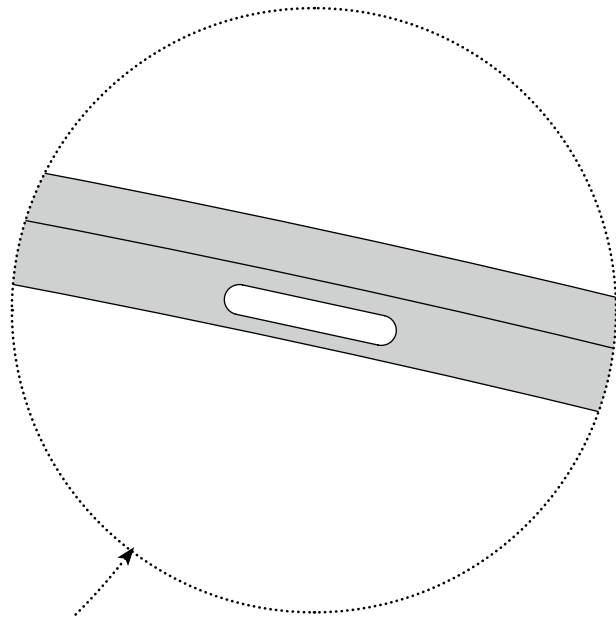
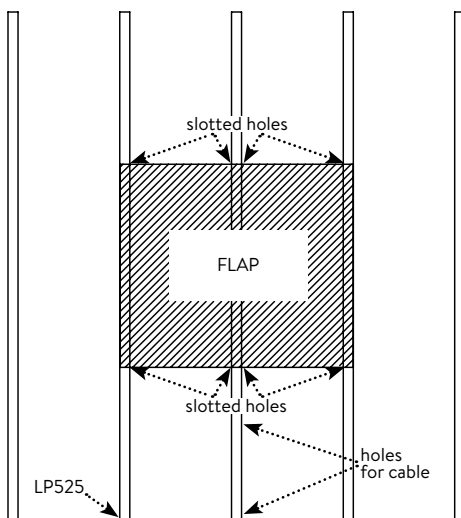

- **Crossbeams (4x)**



The slotted holes in the profiles of the barrel vault.

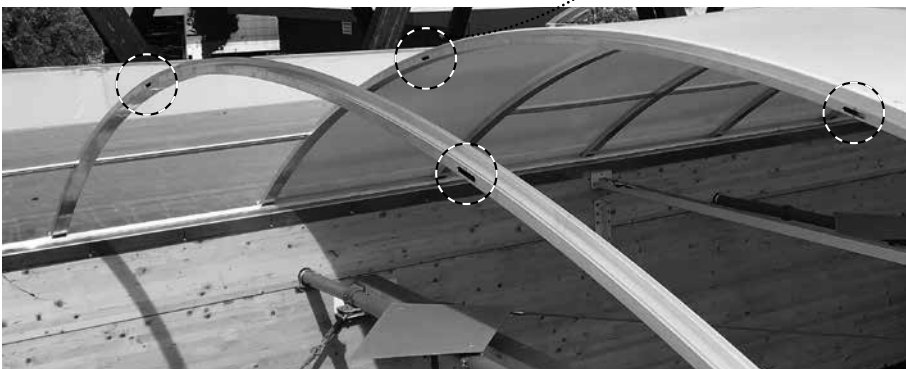

Position the crossbeams in the slotted holes.



Fix the 4 crossbeams with 4 M6 x 70 mm bolts.



Fix without gaps between the crossbeams and LP525.

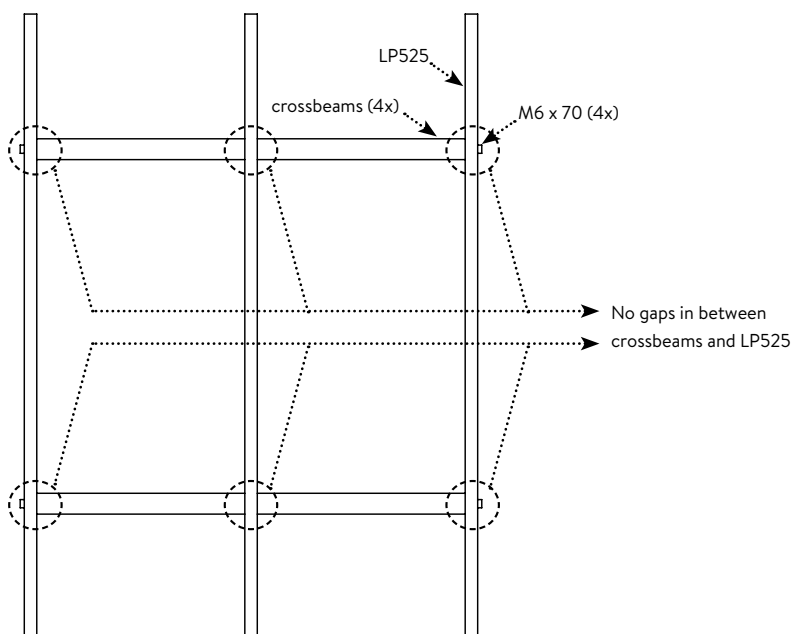

- **Arch stabilizers (GDGL) + PC sheets (4x & 4x)**

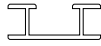

Place the arch stabilizers in position. Remove protective films from bottom and top of the sheets. Slide the PC sheet in the crossbeam below the single flap.



Attach the sheet with the closure profile (LP025) on the lateral profile (LP625 or LP125).



- **PC sheets of the barrel vault**

Mount all the PC sheets of the barrel vault before continuing with the flap.

After installation of the fixed parts of the barrel vault, the safety nets can be partly removed in order to make it possible to install the opening system with an aerial work platform. If the roof opening is not completely secured (anymore) by safety nets, lifelines for all workers on the roof are mandatory!

- **Finish barrel vault**

Position the 3 upper curved profiles from the opening system in the same way as the other upper curved profiles (see mounting instructions barrel vault), but do not tighten the M8 bolts yet. First, position the 4 PVC tubes between the upper and lower profiles, then tighten the M8 bolts.

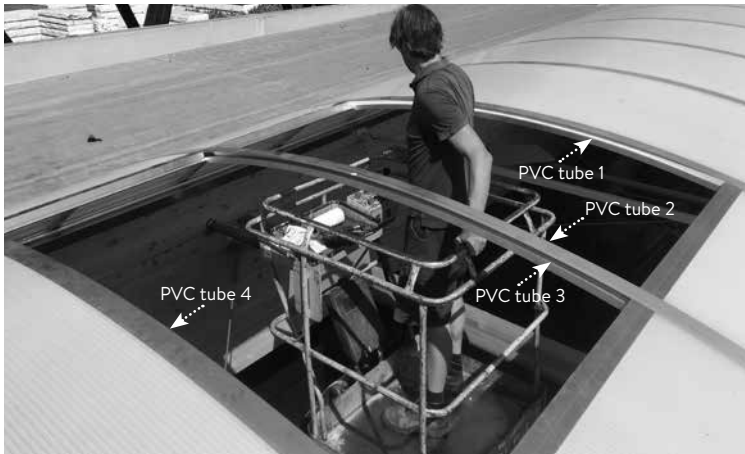

- **Bottom frame (1x)**

Position the frame so that you can see the screw lines through the pre-drilled holes. Make sure the opening where the bottom frame will be mounted has perfectly straight corners (see p.4 – squareness barrel vault). Screw all the 11 + 6 screws on the hinge side in the pre-drilled holes.

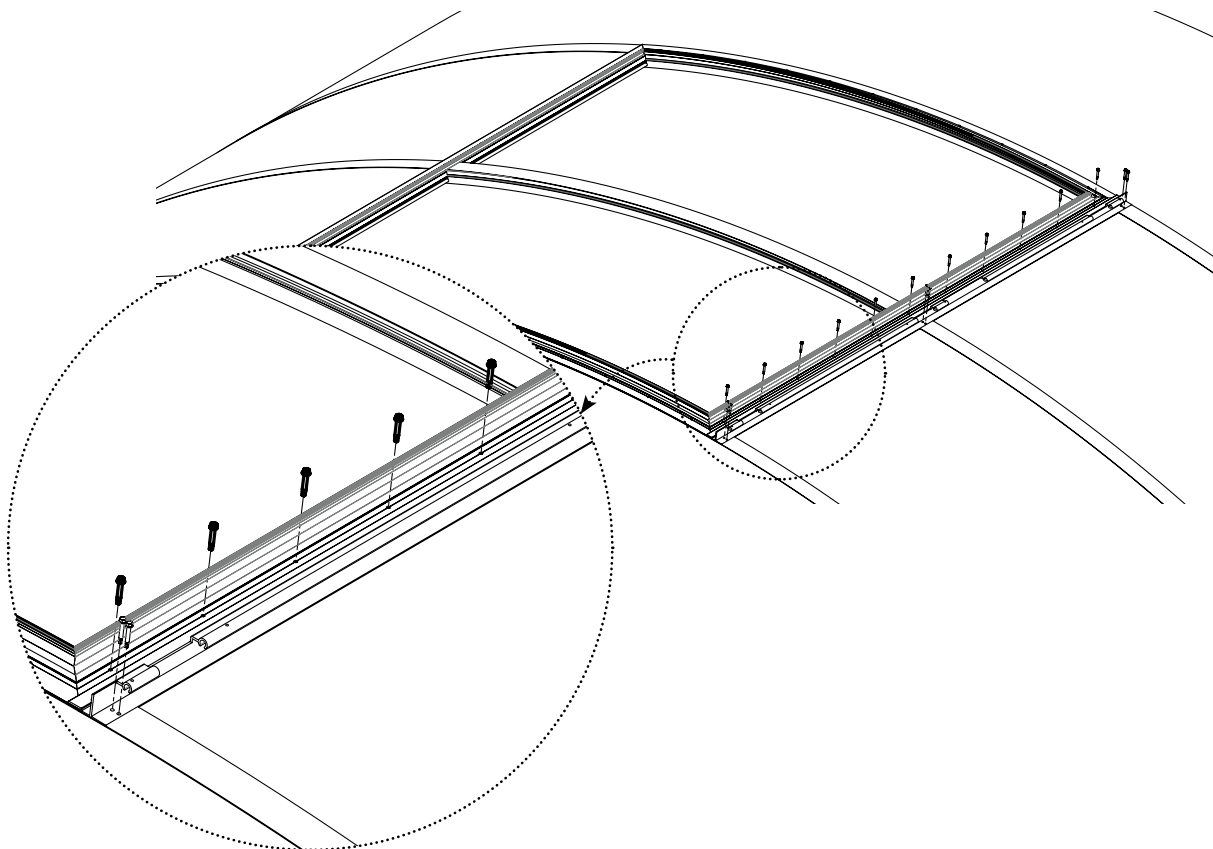

Fix the sides of the frame. Start at the hinge side. **Align** the frame with the upper curved profile.

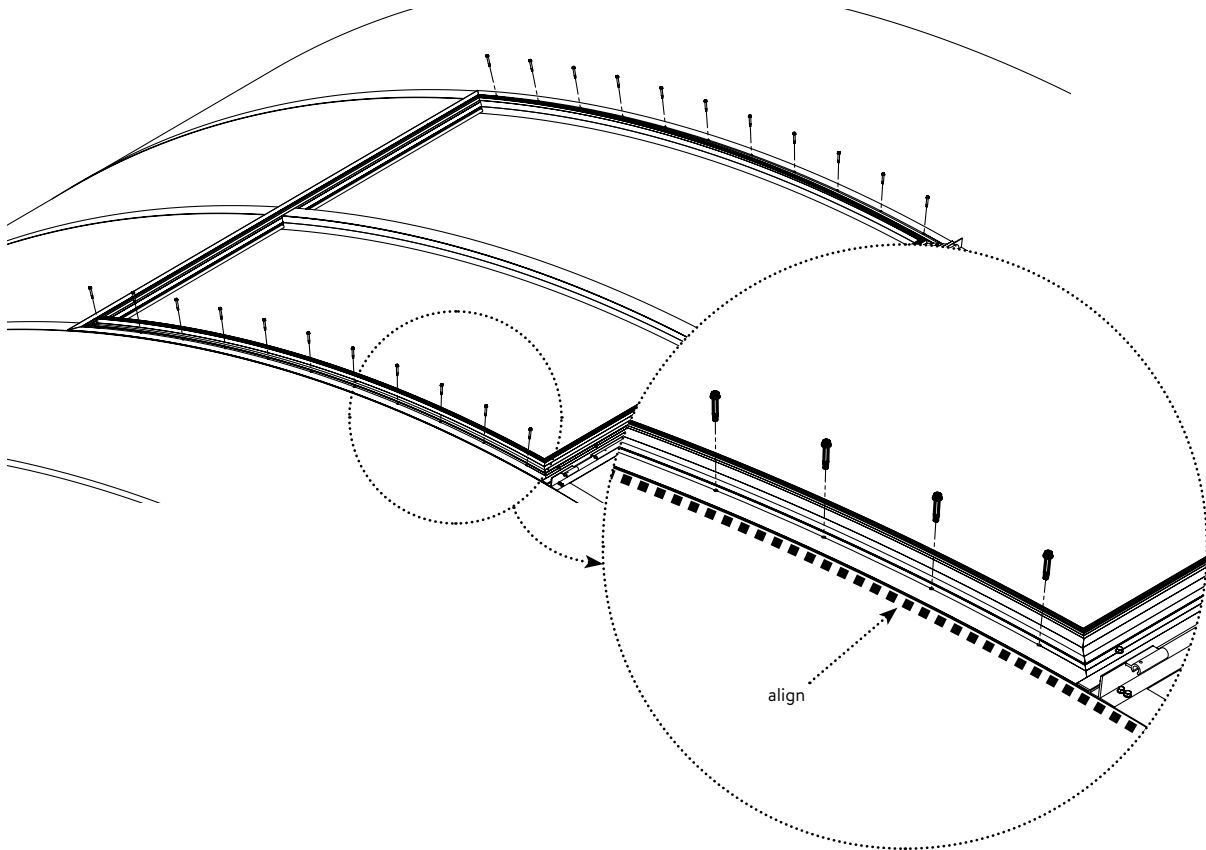

Fix the screws in the following order:

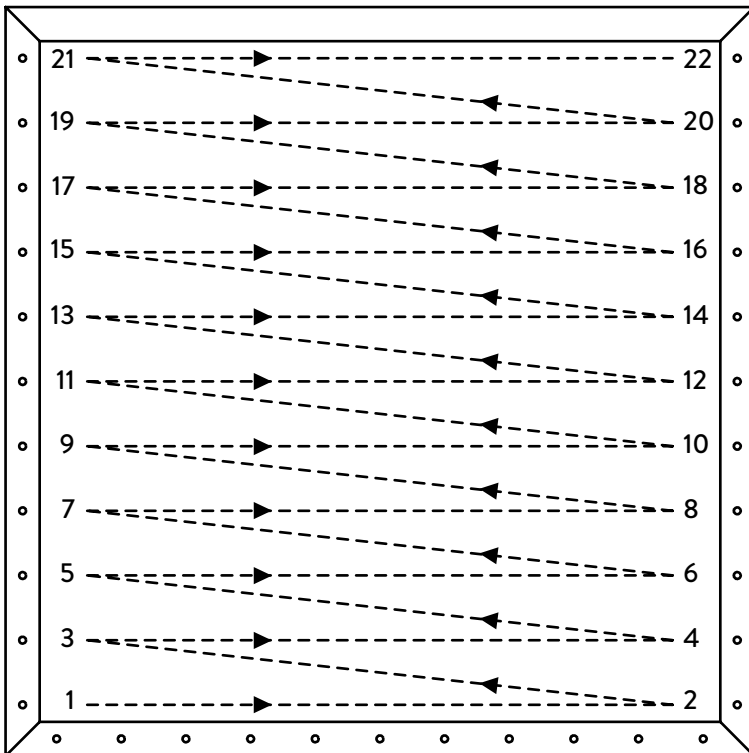

Fix the last side.

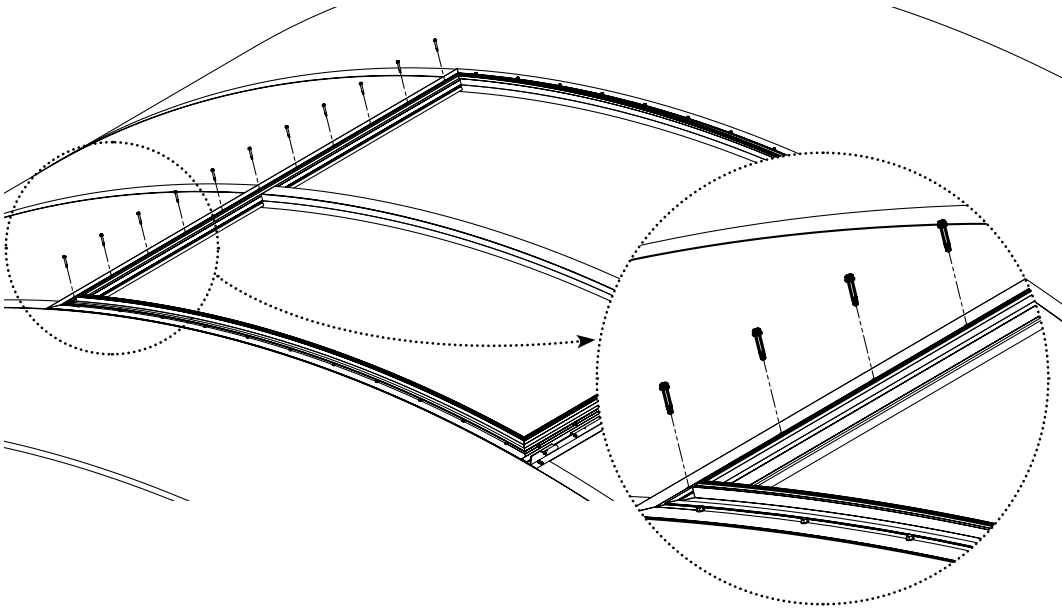

- **Top frame (1x)**

Place the top frame on top of the bottom frame and position it so the hinges of the 2 frames fit into each other.

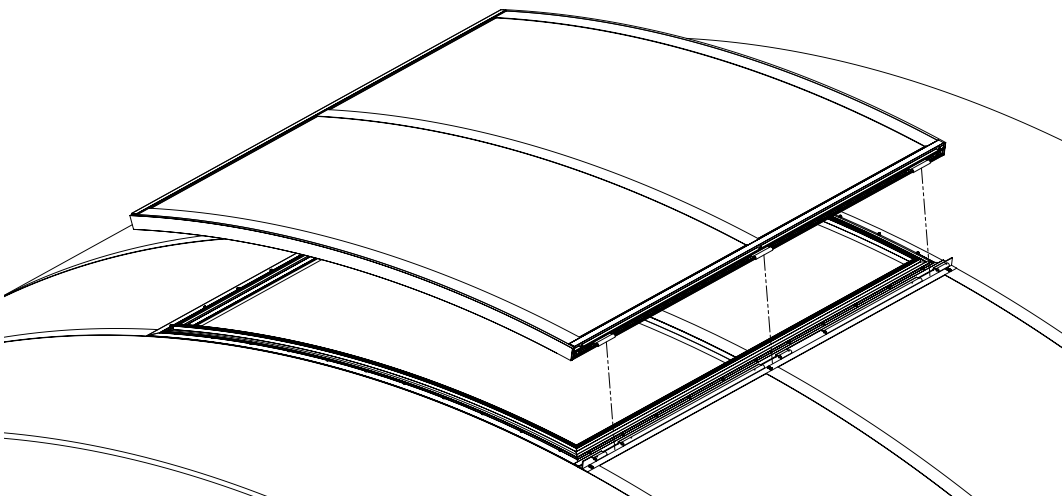

- **Hinge pins and screws (3x & 6x)**

Push the 3 pins in the hinge and shift them between the 2 pre-drilled holes.

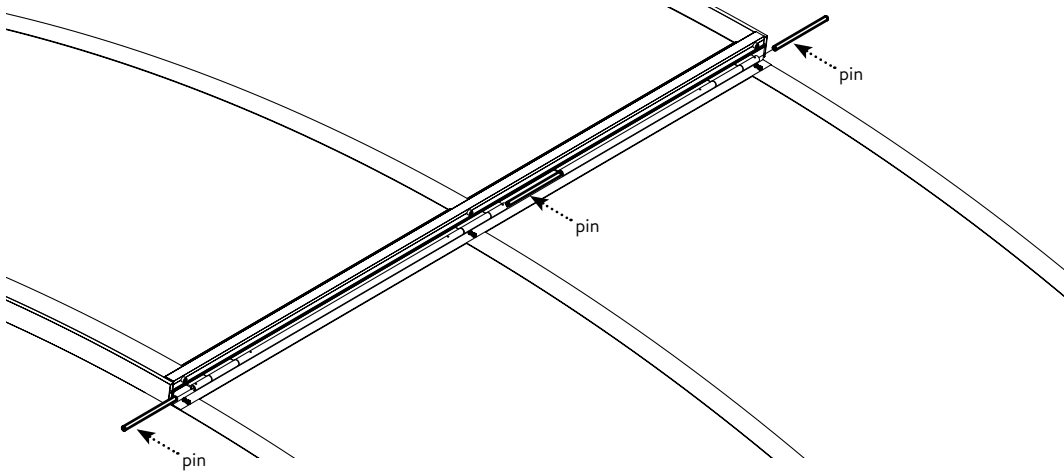

Mount the 2 screws on each side to block the pins (3x).

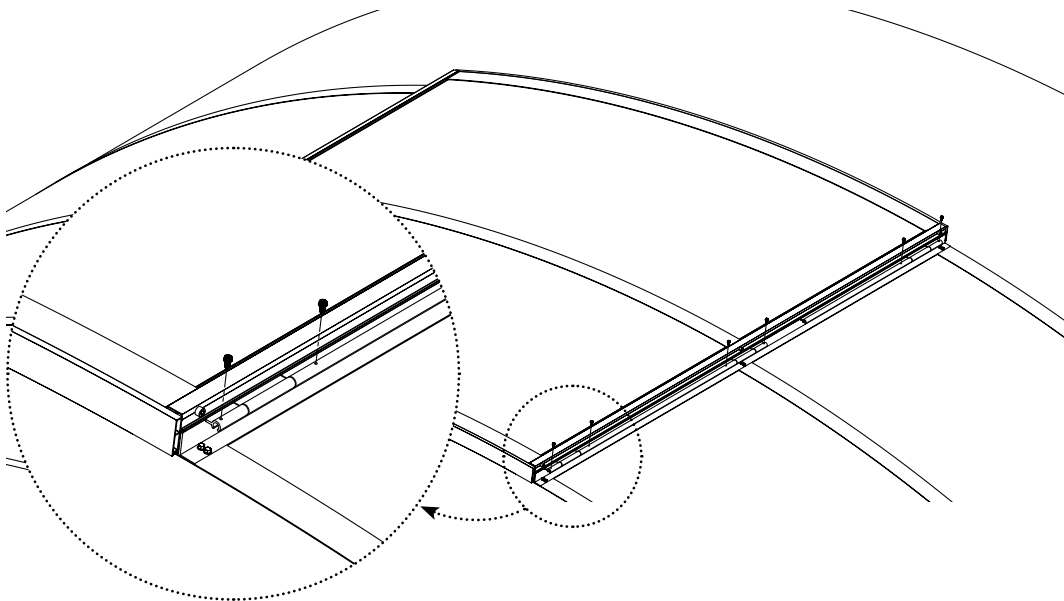

Assembly sequence motor

1 Lock

Mount the lock on the bracket with 4 M6 bolts.



2 Traverse with cylinder

Loosen the 4 bolts a little, so the angle of the bracket can be adjusted. 2 bolts on each side.



Fix the traverse to the crossbeams with 6 screws on each side. Mount the traverse on the same side of the curved aluminium profile as the lock. There are no screw lines on the bottom for the 3 screws. Push the traverse completely against the curved aluminium profile.



There are screw lines provided for the 3 screws on the front.



IF YOU INSTALL A SHE VERSION WITHOUT AN ELECTRIC VENTILATION MOTOR, GO TO STEP 4.

3 Ventilation motor (Combi only)

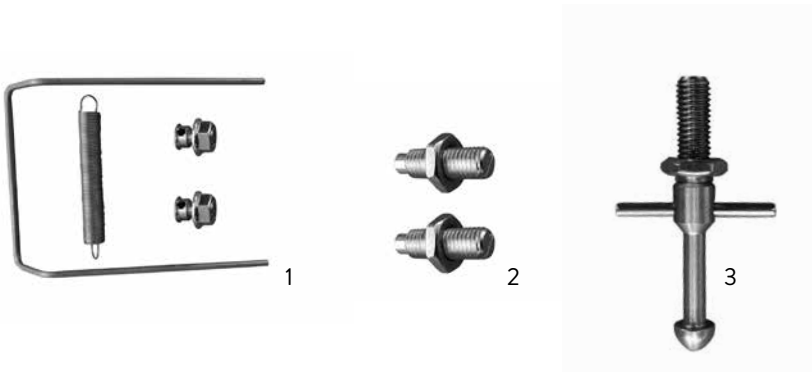

Replace the eye-bolt with the locking pin.

Mount the locking pin (3).



Remove the tube with locking pin (only used for SHE Pn without electric ventilation motor).
Loosen the 2 bolts on the sides and remove the tube.



Mount the 4 screws (1, 2) in the holes as shown in the photo. Do not tighten the 4 screws.



Now you can install the ventilation motor and tighten the 2 screws and locknuts that hold the motor in position. It is important that the motor is positioned in the centre.



Now mount the u-shaped wire bracket with the spring (1). When the electro motor hangs vertically, fix the wire bracket in the same way as in the photo below so that it just touches the motor.



Attach the spring (1) to the bottom side of the bracket.



4 Pneumatic cylinder

Close the flap, but place a piece of wood (± 20 cm) between the top and lower frame. This makes it easier to attach the pneumatic cylinder.



Pull out the rod of the pneumatic cylinder and fix it to the lock. If necessary, disconnect the flexible tube as shown below so you can pull out the rod.



Remove the pin of the lock. Extend the rod so the holes of the lock and rod are aligned. Push the pin through the holes and lock with a safety pin.



Reconnect the flexible tube.

5 CO₂ bottle

Remove the blue protection cap. Turn in the black clamping bolt completely.



Tighten the glass bulb between the hole and the small axle.



Remove the red protection cap and screw the holder with glass bulb. Do not screw it very hard, otherwise the glass bulb will break.



Now loosen the black clamping bolt and screw the CO₂ gas bottle firmly in the same hole.



6 Locking pin adjustment

Combi version:



SHE version:



Make sure that the little axle of the locking pin is in a straight line when tightening the locking pin, as shown below.

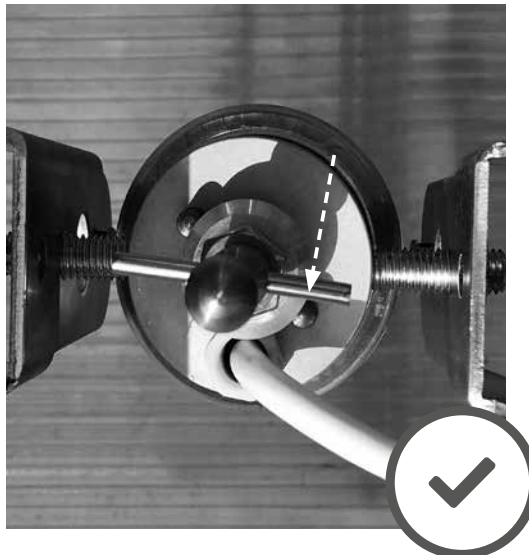

Adjust the height of the locking pin so that the seals are well tightened when closed.
 Locking pin height Combi: ± 7.5 cm / Locking pin height SHE Pn: ± cm

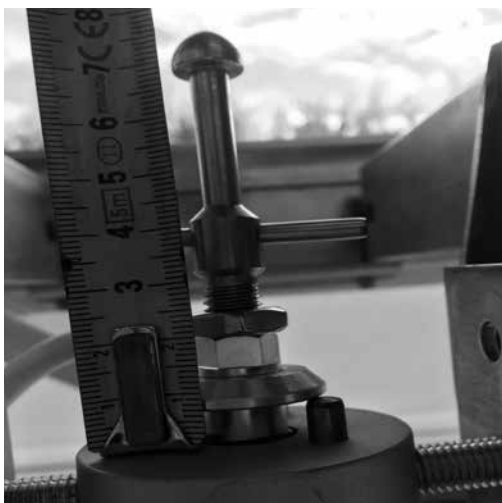

Now close the single flap and push it down until it 'clicks' in the lock. Adjust the locking pin if needed.

7 Electrical connection (Combi only)

Connect all the wires according to the wiring diagram.

Maintenance and periodic test

The owner of the building must schedule an annual maintenance on the Cintralux single flap and the fixed parts of the barrel vault. The maintenance should include at least the cleaning of the sheets with water and light neutral soap. All attachments must be inspected and loose or damaged parts of the Cintralux must immediately be fixed or replaced by original parts.

Clean the condensation drain holes and the inside of the base profile when needed or at least once a year.

Clean wind & rain sensor as required.

The functions of the SHE must be tested by authorised personnel at least once a year.

Please contact our SHE service for more information or inquiries: T: +32 (0)56 24 81 03 - E: service@skylux.be

	Maintenance Date	Maintained by	System Check	Battery Check	Remarks
Year 0/...../20.....				
Year 1/...../20.....				
Year 2/...../20.....				
Year 3/...../20.....				
Year 4/...../20.....				
Year 5/...../20.....				
Year 6/...../20.....				
Year 7/...../20.....				
Year 8/...../20.....				
Year 9/...../20.....				
Year 10/...../20.....				
Year 11/...../20.....				
Year 12/...../20.....				
Year 13/...../20.....				
Year 14/...../20.....				
Year 15/...../20.....				

Warnings

Installers: installation must be performed by trained technicians with sufficient knowledge of and experience in the installation of barrel vaults.

Fixing materials: use suitable fixing material depending on the surface and the load. If any doubt, contact the screw supplier or a specialised engineering firm. We supply fixing material that is suitable for most metal or wooden surfaces, but this needs to be checked before starting the installation. Skylux is not responsible for the fixing materials used.

Performances: use the flap in the specified performance range (CE). Exceeding the performances may result in failure and or damage.

Compatibility: only use polycarbonate-friendly materials. Avoid using silicone, polyurethane foam, detergents, paints, varnishes, timber protectants, lubricants, insecticides, etc. A lead flashing must not come into contact with the multi-walled sheets.

Covering: cover the barrel vault (e.g. heat-deflecting effect) only with a cloth that does not contain softening agents. It is not recommended to cover acrylic or polycarbonate with a coating or paint. In this case, our guarantee will no longer apply. It is in your interest that the manufacturer of the coating or paint provides guarantee on compatibility with acrylic and polycarbonate.

Dust: if there are still certain works to be carried out that entail the release of dust particles (such as grinding, drilling, plaster work, etc.), then the opening under the barrel vault must be hermetically sealed, for example with a PVC film. The dust can accumulate on, in, or between the plastic sheets. The hollow channels of the multi-walled sheets are sealed off with tape. When sawing multi-walled sheets at the project site, all channels must be carefully blown out and sealed off with suitable tape. Before assembly, double check that the channels are properly taped and adjust where necessary. Make sure the tape has not been damaged during assembly. There is no warranty for dust inclusion.

UV side and scratches: always install the multi-walled sheets with the UV protective side facing up. This 'sunny side' is indicated on the protective film. Remove the protective film just before installation to avoid scratches.

Point load: avoid point load on multi-walled sheets as this can cause permanent imprints. Never lean or walk on the multi-walled sheets.

Snow accumulation: do not install barrel vaults in places where snow can slide from a higher structure and fall on the barrel vault.

Original parts: only use original parts and install them according to the assembly instructions.

Skylux reserves the right to modify this product or these instructions without prior notice. Changes to the assembly instructions or to the product carry no right to compensation or exchange of parts. The most recent version of these instructions can be consulted at any time at www.skylux.be.

Always close the single flap in case of rain or strong wind.

Physical properties multi-walled sheets:

expansion and contraction sounds: acrylic and polycarbonate sheets are plastic sheets and will expand and contract in case of temperature fluctuations. The profile system allows this expansion and contraction. This might cause some noise.

Condensation: acrylic and polycarbonate sheets are very little permeable to damp, which can cause condensation in the hollow channels of the sheets. This could mostly happen at the beginning of the installation because there is a lot of construction liquid that must evaporate. This is a physical phenomenon and disappears after some time. The condensation has no influence on the characteristics of the plastic sheets or on the guarantee.

Reflection: in some cases, acrylic and polycarbonate sheets can reflect the sunlight to the inside or outside, depending on orientation and pitch.

Safety during assembly

Take the necessary and required safety precautions, such as safety nets in the roof opening(s), fall protection, protection of the roof edge, safety shoes, safety goggles, gloves, hard hat, etc.

Every electrical operation must be carried out by an electrically trained installer.

Safety nets & lifelines:

The roof opening must be secured completely with safety nets before starting the installation of the barrel vault and flap. After installation of the fixed parts of the barrel vault, the safety nets can be partly removed in order to make it possible to install the opening system with an aerial work platform. If the roof opening is not completely secured (anymore) by safety nets, lifelines for all workers on the roof are mandatory!

Falling from height



- When using ladders:
 - Ladder in good condition?
 - Set up correctly at an angle of 75°?
 - Secured below and on top against moving?
 - Don't take heavy material with you on the ladder!
- Do not lift material over the roof edge; use a crane to put the material on the roof.
- Make sure the roof is secure enough, e.g. secure the edge or use a scaffold so no one can fall off the roof. If the roof is not secured enough, always use harness with lifeline, attached to a suitable attachment point.
- Make sure the roof is stable and does not have dangerous openings or insufficient secure parts (e.g. corrugated sheets, ...). Take the necessary measures if this is not the case: strengthen, place safety nets below dangerous zones, ...
- Do not walk/lean/lie on the barrel vault.
- Safety nets conform to the current legislation are always necessary during constructions on the barrel vault. The nets must be attached firmly and sufficiently to the building.
- When using an aerial work platform: always wear a harness. Leaving the cage is forbidden.
- Never walk backwards on a roof, always walk forwards.
- Make sure there's enough light in the working zone.



Low-hanging obstacles and falling loads



- Forbidden to walk under or within a radius of 1 m of a hanging or lifted load.
- Demarcate the danger zone below the barrel vault so people cannot be hit by any falling loads. People are not allowed in the demarcated danger zone during construction.

Crushing hazard



- All working tools are in good condition, provided with a valid CE label and all necessary safety regulations. These cannot be removed.
- People who use these working tools are educated for this purpose. Protections are always present on all working tools. They are in good condition and need to be set correctly.

Tripping/falling



- Safety is key and it begins with order and tidiness. Clean everything immediately, leave nothing lying around.
- Trash needs to be sorted.
- Be cautious with electric cables (danger of tripping/falling). Never walk backwards!
- Make sure there's enough light in the working zone.

Sharp objects



- Make sure your fingers/hands are not pinched and watch out for cuts while handling aluminium profiles.
- Be careful where you put your hands during the installation.
- Wearing cut-resistant gloves is mandatory.



Ergonomics



- Always lift loads correctly: bend your knees, move your feet instead of forcing your spine, lift as close to your body as possible.
- Parts of more than 25 kg must be lifted with at least 2 persons.

Personal protective equipment



- Work clothes, safety shoes and helmet are mandatory for everyone.



- Lifeline and harness are mandatory if the edge is not secured enough or if there are no safety nets below the barrel vault. They are also necessary when using an aerial working platform.



- Use gloves when handling aluminium profiles.



- Safety glasses and hearing protection are mandatory when using saws / grinders.

If in doubt: STOP! Do not take unnecessary risks. Ask your buddy or superior if needed.

ONLY USE ORIGINAL PARTS SUPPLIED BY SKYLUX. FAILURE TO USE ORIGINAL PARTS VOIDS THE GUARANTEE.

THESE GUIDELINES ONLY SERVE AS ADVICE AND INFORMATION. INSTALLATION IS CONDUCTED UNDER THE SOLE RESPONSIBILITY OF THE CUSTOMER.

THE DOP CAN ALSO BE FOUND ON THE WEBSITE WWW.CINTRALUX.COM.

CINTRALUX IS A REGISTERED BRAND OF SKYLUX
SPINNERIJSTRAAT 100 - B-8530 STASEGEM
T +32 (0)56 20 00 00 - F +32 (0)56 21 95 99
INFO@SKYLUX.BE
WWW.SKYLUX.BE

SKYLUX[®]
Hello daylight!