

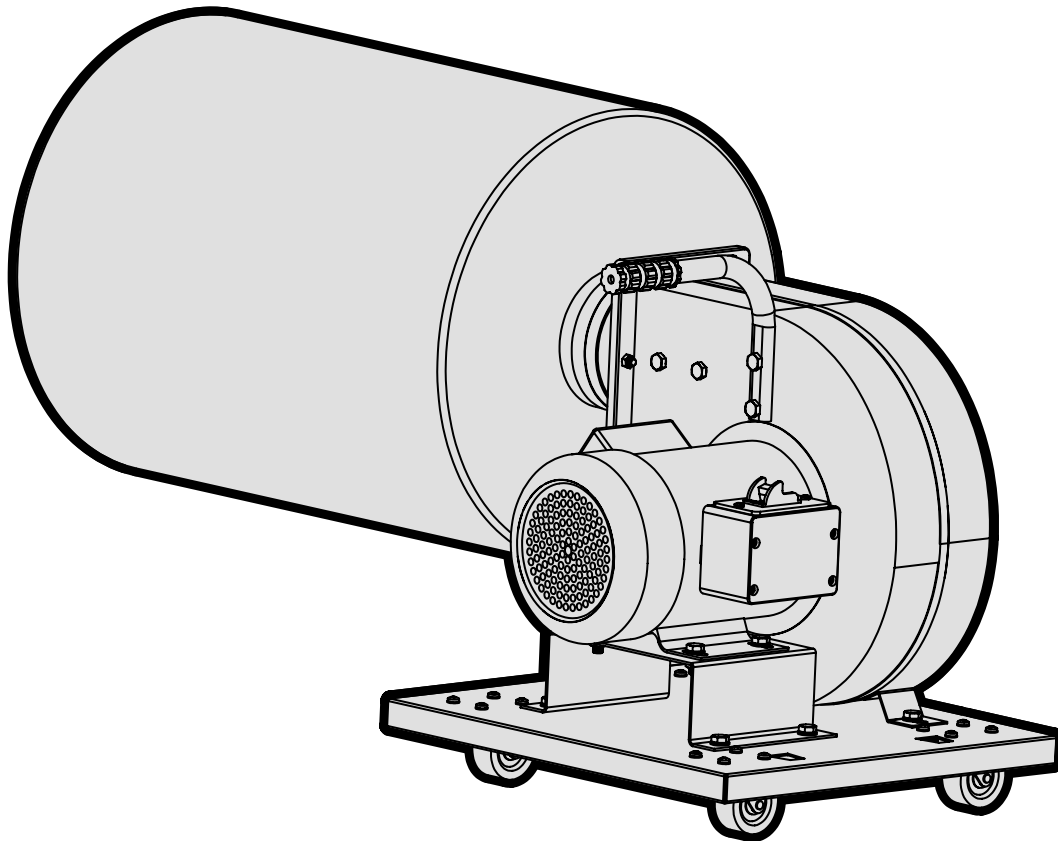

MODEL DC3402

600 CFM DUST COLLECTOR

Instruction Manual



NEED HELP? CONTACT US!

Have product questions? Need technical support? Please feel free to contact us:



1-800-232-1195 (M-F 8AM-5PM CST)



TECHSUPPORT@WENPRODUCTS.COM

IMPORTANT: Your new tool has been engineered and manufactured to WEN's highest standards for dependability, ease of operation, and operator safety. When properly cared for, this product will supply you years of rugged, trouble-free performance. Pay close attention to the rules for safe operation, warnings, and cautions. If you use your tool properly and for its intended purpose, you will enjoy years of safe, reliable service.

For replacement parts and the most up-to-date instruction manuals, visit ***WENPRODUCTS.COM***

CONTENTS

WELCOME	3
Introduction	3
Specifications.....	3
SAFETY	4
General Safety Rules	4
Dust Collector Safety Warnings	6
Electrical Information.....	7
BEFORE OPERATING	8
Unpacking & Packing List	8
Know Your Dust Collector	8
Assembly & Adjustments.....	9
OPERATION & MAINTENANCE	10
Operation	10
Maintenance.....	11
Troubleshooting Guide.....	12
Exploded View & Parts List.....	13
Warranty Statement	15

To purchase accessories for your tool, visit ***WENPRODUCTS.COM***

10-Foot Dust Hose (Model 28200)

20-Foot Dust Hose (Model 28221)

INTRODUCTION

Thanks for purchasing the WEN Dust Collector. We know you are excited to put your tool to work, but first, please take a moment to read through the manual. Safe operation of this tool requires that you read and understand this operator's manual and all the labels affixed to the tool. This manual provides information regarding potential safety concerns, as well as helpful assembly and operating instructions for your tool.

 Indicates danger, warning, or caution. The safety symbols and the explanations with them deserve your careful attention and understanding. Always follow the safety precautions to reduce the risk of fire, electric shock or personal injury. However, please note that these instructions and warnings are not substitutes for proper accident prevention measures.

NOTE: The following safety information is not meant to cover all possible conditions and situations that may occur. WEN reserves the right to change this product and specifications at any time without prior notice.

At WEN, we are continuously improving our products. If you find that your tool does not exactly match this manual, please visit wenproducts.com for the most up-to-date manual or contact our customer service at **1-800-232-1195**.

Keep this manual available to all users during the entire life of the tool and review it frequently to maximize safety for both yourself and others.

SPECIFICATIONS

Model number	DC3402
Motor	120V, 60 Hz, 7.4A
Motor Speed	3450 RPM (No-Load)
Airflow Capacity	600 CFM
Collection Bag Capacity	15 Gallons
Collection Bag Micron Rating	5 Microns
Inlet Diameter	4 Inches
Impeller Diameter	9 Inches
Dimensions	43.3 in. x 17.7 in. x 20.1 in.
Weight	42.9 Pounds

GENERAL SAFETY RULES

⚠ WARNING! Read all safety warnings and all instructions. Failure to follow the warnings and instructions may result in electric shock, fire and/or serious injury.

Safety is a combination of common sense, staying alert and knowing how your item works. The term “power tool” in the warnings refers to your mains-operated (corded) power tool or battery-operated (cordless) power tool.

SAVE THESE SAFETY INSTRUCTIONS.

WORK AREA SAFETY

- 1. Keep work area clean and well lit.** Cluttered or dark areas invite accidents.
- 2. Do not operate power tools in explosive atmospheres, such as in the presence of flammable liquids, gases or dust.** Power tools create sparks which may ignite the dust or fumes.
- 3. Keep children and bystanders away while operating a power tool.** Distractions can cause you to lose control.

ELECTRICAL SAFETY

- 1. Power tool plugs must match the outlet. Never modify the plug in any way. Do not use any adapter plugs with earthed (grounded) power tools.** Unmodified plugs and matching outlets will reduce risk of electric shock.
- 2. Avoid body contact with earthed or grounded surfaces such as pipes, radiators, ranges and refrigerators.** There is an increased risk of electric shock if your body is earthed or grounded.
- 3. Do not expose power tools to rain or wet conditions.** Water entering a power tool will increase the risk of electric shock.
- 4. Do not abuse the cord. Never use the cord for carrying, pulling or unplugging the power tool. Keep cord away from heat, oil, sharp edges or moving parts.** Damaged or entangled cords increase the risk of electric shock.
- 5. When operating a power tool outdoors, use an extension cord suitable for outdoor use.** Use of a cord suitable for outdoor use reduces the risk of electric shock.

- 6. If operating a power tool in a damp location is unavoidable, use a ground fault circuit interrupter (GFCI) protected supply.** Use of a GFCI reduces the risk of electric shock.

PERSONAL SAFETY

- 1. Stay alert, watch what you are doing and use common sense when operating a power tool. Do not use a power tool while you are tired or under the influence of drugs, alcohol or medication.** A moment of inattention while operating power tools may result in serious personal injury.
- 2. Use personal protective equipment. Always wear eye protection.** Protective equipment such as a respiratory mask, non-skid safety shoes and hearing protection used for appropriate conditions will reduce the risk of personal injury.
- 3. Prevent unintentional starting. Ensure the switch is in the off-position before connecting to power source and/or battery pack, picking up or carrying the tool.** Carrying power tools with your finger on the switch or energizing power tools that have the switch on invites accidents.
- 4. Remove any adjusting key or wrench before turning the power tool on.** A wrench or a key left attached to a rotating part of the power tool may result in personal injury.
- 5. Do not overreach. Keep proper footing and balance at all times.** This enables better control of the power tool in unexpected situations.
- 6. Dress properly. Do not wear loose clothing or jewelry. Keep your hair and clothing away from moving parts.** Loose clothes, jewelry or long hair can be caught in moving parts.

GENERAL SAFETY RULES

⚠ WARNING! Read all safety warnings and all instructions. Failure to follow the warnings and instructions may result in electric shock, fire and/or serious injury.

Safety is a combination of common sense, staying alert and knowing how your item works. The term “power tool” in the warnings refers to your mains-operated (corded) power tool or battery-operated (cordless) power tool.

SAVE THESE SAFETY INSTRUCTIONS.

7. If devices are provided for the connection of dust extraction and collection facilities, ensure these are connected and properly used. Use of dust collection can reduce dust-related hazards.

POWER TOOL USE AND CARE

1. Do not force the power tool. Use the correct power tool for your application. The correct power tool will do the job better and safer at the rate for which it was designed.

2. Do not use the power tool if the switch does not turn it on and off. Any power tool that cannot be controlled with the switch is dangerous and must be repaired.

3. Disconnect the plug from the power source and/or the battery pack from the power tool before making any adjustments, changing accessories, or storing power tools. Such preventive safety measures reduce the risk of starting the power tool accidentally.

4. Store idle power tools out of the reach of children and do not allow persons unfamiliar with the power tool or these instructions to operate the power tool. Power tools are dangerous in the hands of untrained users.

5. Maintain power tools. Check for misalignment or binding of moving parts, breakage of parts and any other condition that may affect the power tool's operation. If damaged, have the power tool repaired before use. Many accidents are caused by poorly maintained power tools.

6. Keep cutting tools sharp and clean. Properly maintained cutting tools with sharp cutting edges are less likely to bind and are easier to control.

7. Use the power tool, accessories and tool bits, etc. in accordance with these instructions, taking into account the working conditions and the work to be performed. Use of the power tool for operations different from those intended could result in a hazardous situation.

8. Use clamps to secure your workpiece to a stable surface. Holding a workpiece by hand or using your body to support it may lead to loss of control.

9. KEEP GUARDS IN PLACE and in working order.

SERVICE

1. Have your power tool serviced by a qualified repair person using only identical replacement parts. This will ensure that the safety of the power tool is maintained.

CALIFORNIA PROPOSITION 65 WARNING

Some dust created by power sanding, sawing, grinding, drilling, and other construction activities may contain chemicals, including lead, known to the State of California to cause cancer, birth defects, or other reproductive harm. Wash hands after handling. Some examples of these chemicals are:

- Lead from lead-based paints.
- Crystalline silica from bricks, cement, and other masonry products.
- Arsenic and chromium from chemically treated lumber.

Your risk from these exposures varies depending on how often you do this type of work. To reduce your exposure to these chemicals, work in a well-ventilated area with approved safety equipment such as dust masks specially designed to filter out microscopic particles.

DUST COLLECTOR SAFETY WARNINGS

 **WARNING!** Do not let comfort or familiarity with the product replace strict adherence to product safety rules. Failure to follow the safety instructions may result in serious personal injury.

DUST COLLECTOR SAFETY

1. This dust collector is intended only for collecting wood dust and chips from woodworking machines. Do not use dust collector for anything except wood dust. Material such as liquids, aerosols, metal dust, screws, glass, plastic or rock can cause sparks when coming into contact with any part of the collection system.
2. Never allow steel to come into contact with impeller. Impact with any hard material may result in sparks which may cause fire. Be mindful of any situation that results in a risk of fire.
3. Dust created while using machinery may cause cancer, birth defects, or long-term respiratory damage. Be aware of dust hazards associated with each workpiece material and always wear a NIOSH-approved respirator.
4. Do not place your hands, lumber or tools near the inlet opening while machine is plugged in or during operation. Keep animals and children away from open dust collection inlets.
5. Regularly check and empty the collection bag to avoid the buildup of fine dust that can increase the risk of fire. Regularly clean the surrounding area of the machine. Excessive dust buildup on heat sources such as overhead lights and electrical panels will increase the risk of fire.
6. Always wear a respirator and safety glasses when removing, emptying or replacing the collection bag. Empty dust away from ignition sources and into a suitable container.

These safety instructions can't possibly warn of every scenario that may arise with this tool, always make sure to stay alert and use common sense during operation.

ELECTRICAL INFORMATION

GROUNDING INSTRUCTIONS

In the event of a malfunction or breakdown, grounding provides the path of least resistance for an electric current and reduces the risk of electric shock. This tool is equipped with an electric cord that has an equipment grounding conductor and a grounding plug. The plug **MUST** be plugged into a matching outlet that is properly installed and grounded in accordance with ALL local codes and ordinances.

1. Do not modify the plug provided. If it will not fit the outlet, have the proper outlet installed by a licensed electrician.

2. Improper connection of the equipment grounding conductor can result in electric shock. The conductor with the green insulation (with or without yellow stripes) is the equipment grounding conductor. If repair or replacement of the electric cord or plug is necessary, **DO NOT** connect the equipment grounding conductor to a live terminal.

3. Check with a licensed electrician or service personnel if you do not completely understand the grounding instructions or whether the tool is properly grounded.

4. Use only three-wire extension cords that have three-pronged plugs and outlets that accept the tool's plug. Repair or replace a damaged or worn cord immediately.

CAUTION! In all cases, make certain the outlet in question is properly grounded. If you are not sure, have a licensed electrician check the outlet.

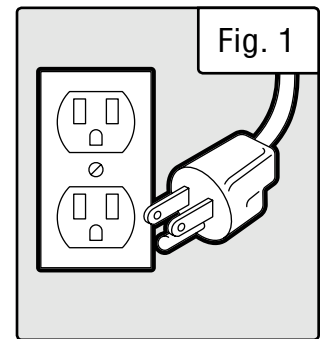

GUIDELINES AND RECOMMENDATIONS FOR EXTENSION CORDS

When using an extension cord, be sure to use one heavy enough to carry the current your product will draw. An undersized cord will cause a drop in line voltage resulting in loss of power and overheating. The table below shows the correct size to be used according to cord length and ampere rating. When in doubt, use a heavier cord. The smaller the gauge number, the heavier the cord.

AMPERAGE	REQUIRED GAUGE FOR EXTENSION CORDS			
	25 ft.	50 ft.	100 ft.	150 ft.
7.4A	18 gauge	16 gauge	14 gauge	12 gauge

1. Examine extension cord before use. Make sure your extension cord is properly wired and in good condition. Always replace a damaged extension cord or have it repaired by a qualified person before using it.

2. Do not abuse extension cord. Do not pull on cord to disconnect from receptacle; always disconnect by pulling on plug. Disconnect the extension cord from the receptacle before disconnecting the product from the extension cord. Protect your extension cords from sharp objects, excessive heat and damp/wet areas.

3. Use a separate electrical circuit for your tool. This circuit must not be less than a 12-gauge wire and should be protected with a 15A time-delayed fuse. Before connecting the motor to the power line, make sure the switch is in the OFF position and the electric current is rated the same as the current stamped on the motor nameplate. Running at a lower voltage will damage the motor.

UNPACKING & PACKING LIST

UNPACKING

With the help of a friend or trustworthy foe, such as one of your in-laws, carefully remove the dust collector from the packaging and place it on a sturdy, flat surface. Make sure to take out all contents and accessories. Do not discard the packaging until everything is removed. Check the packing list below to make sure you have all of the parts and accessories. If any part is missing or broken, please contact customer service at **1-800-232-1195** (M-F 8-5 CST), or email techsupport@wenproducts.com.

PACKING LIST

COMPONENT	QUANTITY
1. Dust Collector	1
2. Outlet	1
3. Casters.....	4
4. Handle.....	1
5. Wall Mounting Brackets	2
6. Bag Hose Clamp.....	1
7. Bag.....	1

KNOW YOUR DUST COLLECTOR

TOOL PURPOSE

Control the mess and minimize cleanup in your shop with your WEN Dust Collector. Refer to the diagram below to become familiarized with the parts and controls of your dust collector.

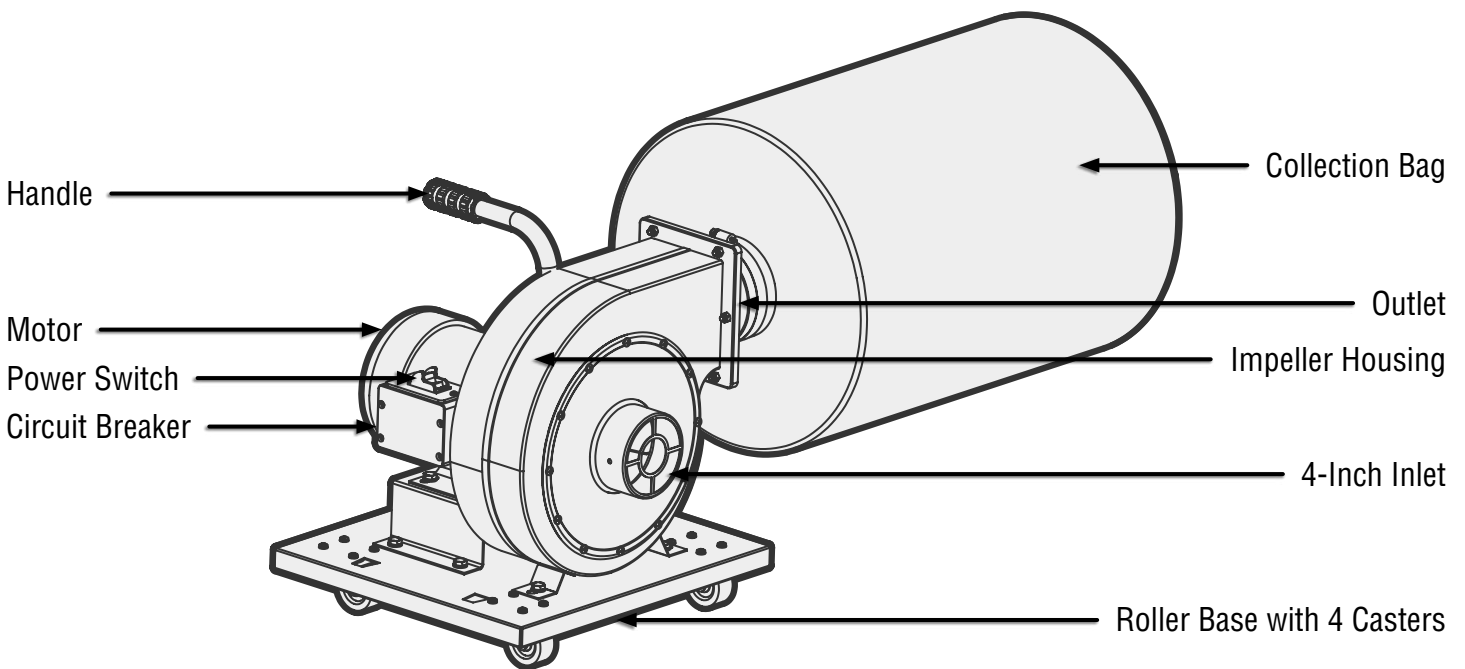

ASSEMBLY & ADJUSTMENTS

ASSEMBLING THE ROLLER BASE

1. Place the machine on its back and attach one of the casters (Fig. 2 - 1) with four M5 bolts (Fig. 2 - 2) and washers (Fig. 2 - 3). Secure the bolts with four nuts (Fig. 2 - 4) on the underside.

2. Repeat step one for the remaining three casters.

ASSEMBLING THE OUTLET

1. Stand the machine upright on the roller base.

2. Insert two M6 bolts (Fig. 3 - 1) into the top two holes of the square outlet and place the rubber gasket (Fig. 3 - 2) onto the bolts.

3. Fit the plastic outlet adapter (Fig. 3 - 3) over the bolts and secure with washers (Fig. 3 - 4) and nuts (Fig. 3 - 5).

NOTE: Do not tighten the nuts completely until all bolts are in position.

4. Add the remaining four bolts and tighten the nuts when all six bolts are in position.

ATTACHING THE HANDLE

1. Attach the handle (Fig. 4 - 1) to the impeller housing using two included M6 bolts (Fig. 4 - 2).

ATTACHING THE DUST COLLECTION BAG

1. Fit the dust collection bag (Fig. 5 - 1) over the round plastic outlet adapter and secure it in place with the included bag hose clamp (Fig. 5 - 2).

2. Tighten the bag hose clamp using a flat head screwdriver (not included).

The dust collector is now ready to use in the horizontal position once connected to your woodworking machine.

MOUNTING THE DUST COLLECTOR TO THE WALL

Two wall brackets are included if you want to mount your dust collection system to the wall.

1. Attach the wall mounting brackets (Fig. 6 -1) to a suitably strong wall using the appropriate fixings.

2. Hook the two cut outs in the base (Fig. 6 - 2) over the wall brackets. The casters can be left in place, allowing for quick mobility around the shop when required.

NOTE: Consult the diagram on the next page for mounting dimensions.

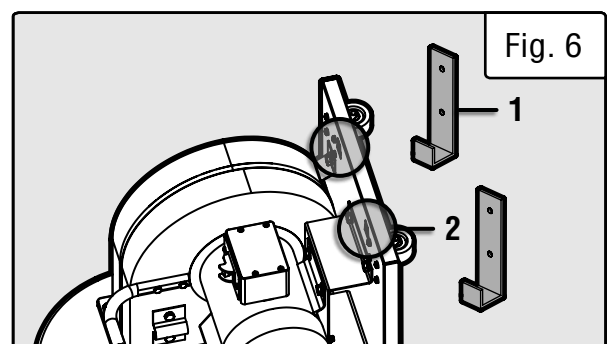
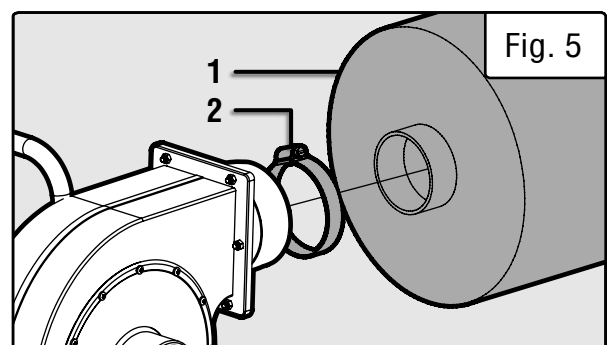
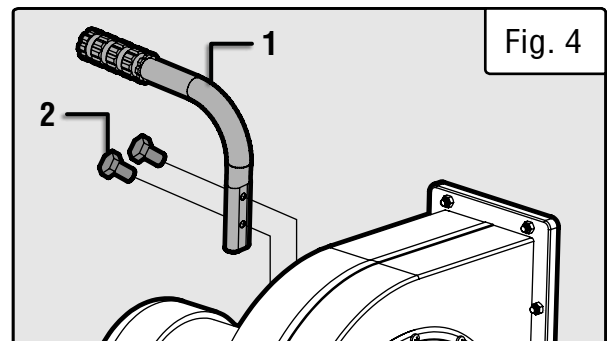
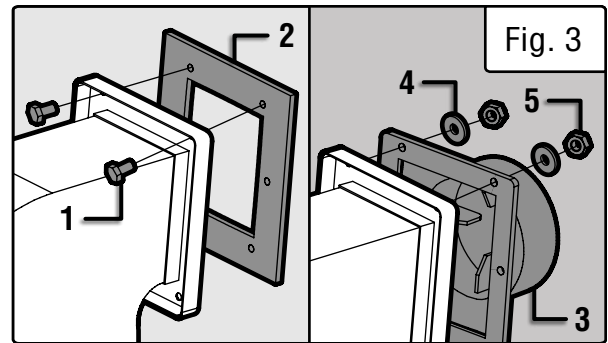
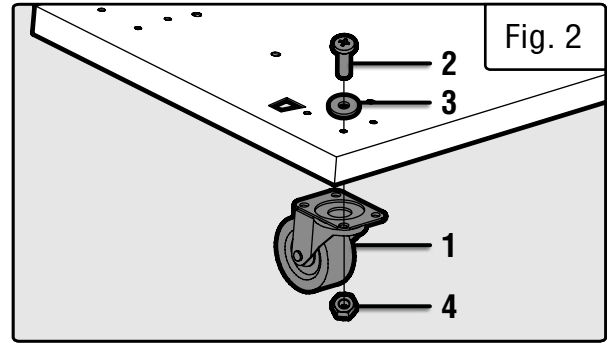

ASSEMBLY & ADJUSTMENTS

MOUNTING DIMENSIONS

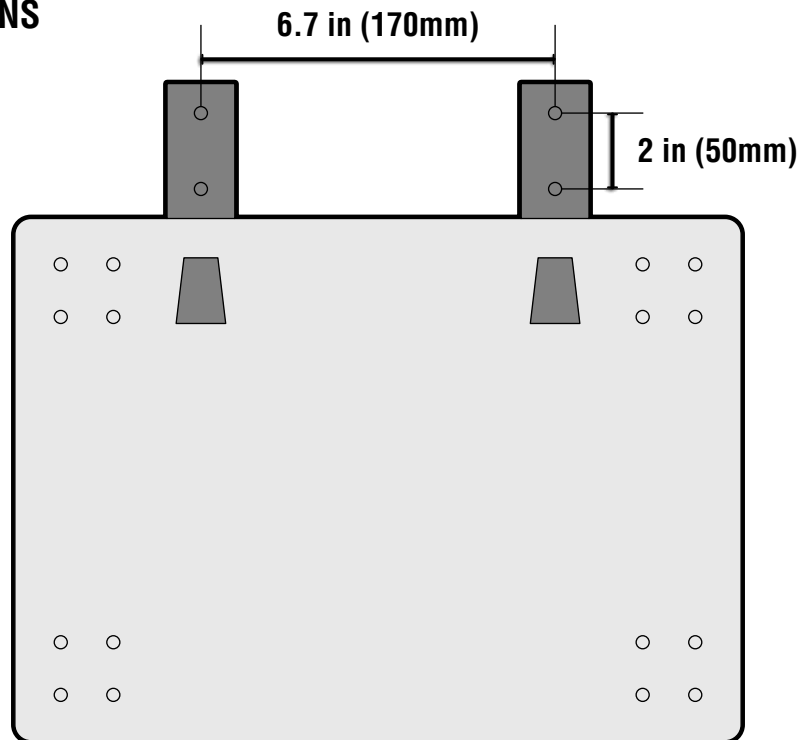

OPERATION

⚠ WARNING! This dust collector is intended only for collecting wood dust and chips from woodworking machines. Do not use dust collector for anything except wood dust. Material such as liquids, aerosols, metal dust, screws, glass, plastic or rock can cause sparks when coming into contact with any part of the collection system.

⚠ WARNING! Never allow steel to come into contact with impeller. Impact with any hard material may result in sparks which may cause fire. Be mindful of any situation that results in a risk of fire.

1. Connect the dust collector to your woodworking machine using a 4-inch dust collection hose.

NOTE: Your dust collector is compatible with the **WEN 28200 10-foot dust hose** and the **WEN 28221 20-foot dust hose**, available at wenproducts.com. Adaptors may be needed depending on the port size of your machine.

2. Make sure the dust collector switch is turned off and insert the power plug into a matching receptacle.

3. Switch on the dust collector and start operating your woodworking machine. Do not place your hands, lumber or tools near the inlet opening while machine is plugged in or during operation. Keep animals and children away from open dust collection inlets.

NOTE: We recommend using your dust collector and woodworking machine on separate circuits, if possible. Some woodworking machines draw large amounts of electrical current, and smaller circuits may not be able to handle the machine and dust collector simultaneously.

4. Allow the dust collector to continue running for a few seconds after you turn off the woodworking machine. This will clear the dust hose.

OPERATION

TIPS AND TRICKS

1. Your dust collector is designed to collect sawdust and other fine particles, such as that produced by sanders, band saws, etc. If you plan to use it with a machine that produces larger chips or shavings, such as a thickness planer or jointer, we recommend using a cyclone separator or similar filter upstream of the dust collector, to prevent clogging.
2. When turning the dust collector on or off, you may hear a clicking sound as the motor spins up or down. This is normal and does not indicate a problem; it is just the motor's centrifugal switch.

OVERLOAD PROTECTION

Your tool is equipped with a circuit breaker to protect the motor from overloading or overheating. In case of overload, the circuit breaker will pop out to shut down the machine. Wait a few minutes, then press the circuit breaker to reset it. Restart the machine to continue operation.

MAINTENANCE

 **WARNING!** Always ensure that the tool is switched off and the plug is removed from the outlet before making any adjustments or maintenance procedures.

CLEANING AND INSPECTION

1. Regularly clean dust, chips and other particles from the machine. If operation is excessively dusty or dirty, frequent inspection of motor is required. Vacuum any particles that may have entered the motor.
2. Inspect the machine for any damaged or worn parts. Replace any damaged parts immediately for safe and efficient operation. Frequently check that all nuts, bolts, screws have not loosened due to vibration.
3. Regularly check and empty the collection bag. Always wear respirator and safety glasses when removing, emptying or replacing collection bags. Empty dust away from ignition sources and into a suitable container. Your dust collector will perform at its best when the collection bag is half full or less.

STORAGE

Store the unit and accessories in a dark, dry, frost-free and well ventilated place, out of the reach of children. The ideal storage temperature is between 50 to 86 °F (10 and 30 °C).

PRODUCT DISPOSAL

Used power tools contain recyclable materials and should not be disposed with household waste. Please take this product to your local recycling facility for responsible disposal and to minimize its environmental impact.

TROUBLESHOOTING GUIDE

⚠ WARNING! Stop using the tool immediately if any of the following problems occur. Repairs and replacements should only be performed by an authorized technician. For any questions, please contact our customer service at **1-(800) 232-1195**, M-F 8-5 CST or email us at techsupport@wenproducts.com.

PROBLEM	CAUSE	SOLUTION
Unit does not start.	1. Unit is not plugged in.	1. Plug unit in.
	2. Wrong extension cord size.	2. Use proper extension cord. Consult the chart on p. 7.
	3. Onboard circuit breaker tripped.	3. Wait a few minutes, then push breaker to reset.
	4. Bad switch.	4. Contact WEN customer service.
	5. Bad motor.	5. Contact WEN customer service.
Unit hums but does not start.	1. Blockage.	1. Unplug and turn off unit. Check that the impeller rotates freely.
	2. Bad start capacitor.	2. Contact WEN customer service.
	3. Bad or misaligned centrifugal switch.	3. Contact WEN customer service.
	4. Bad motor.	4. Contact WEN customer service.
Clicking sound on startup or shutdown.	1. Centrifugal switch is clicking.	1. This is normal and does not indicate a problem.
Performance problems.	1. Blockage at inlet or outlet.	1. Unplug and turn off unit. Remove any blockage from the inlet or outlet.
	2. Filter bag full of chips or dust.	2. Empty filter bag of all chips and dust.
	3. Filter bag needs cleaning.	3. Clean filter bag. Turn inside out and remove dust.
	4. Hose is too long, narrow, or twisted.	4. Avoid bends in the hose. Use a 4" diameter hose if possible. Keep the length as short as possible.
	5. Failed inlet or outlet gasket.	5. Replace gasket.
Unit has sucked up your favorite dust bunny.	1. You weren't paying attention.	1. How could you do such a thing?

EXPLODED VIEW & PARTS LIST

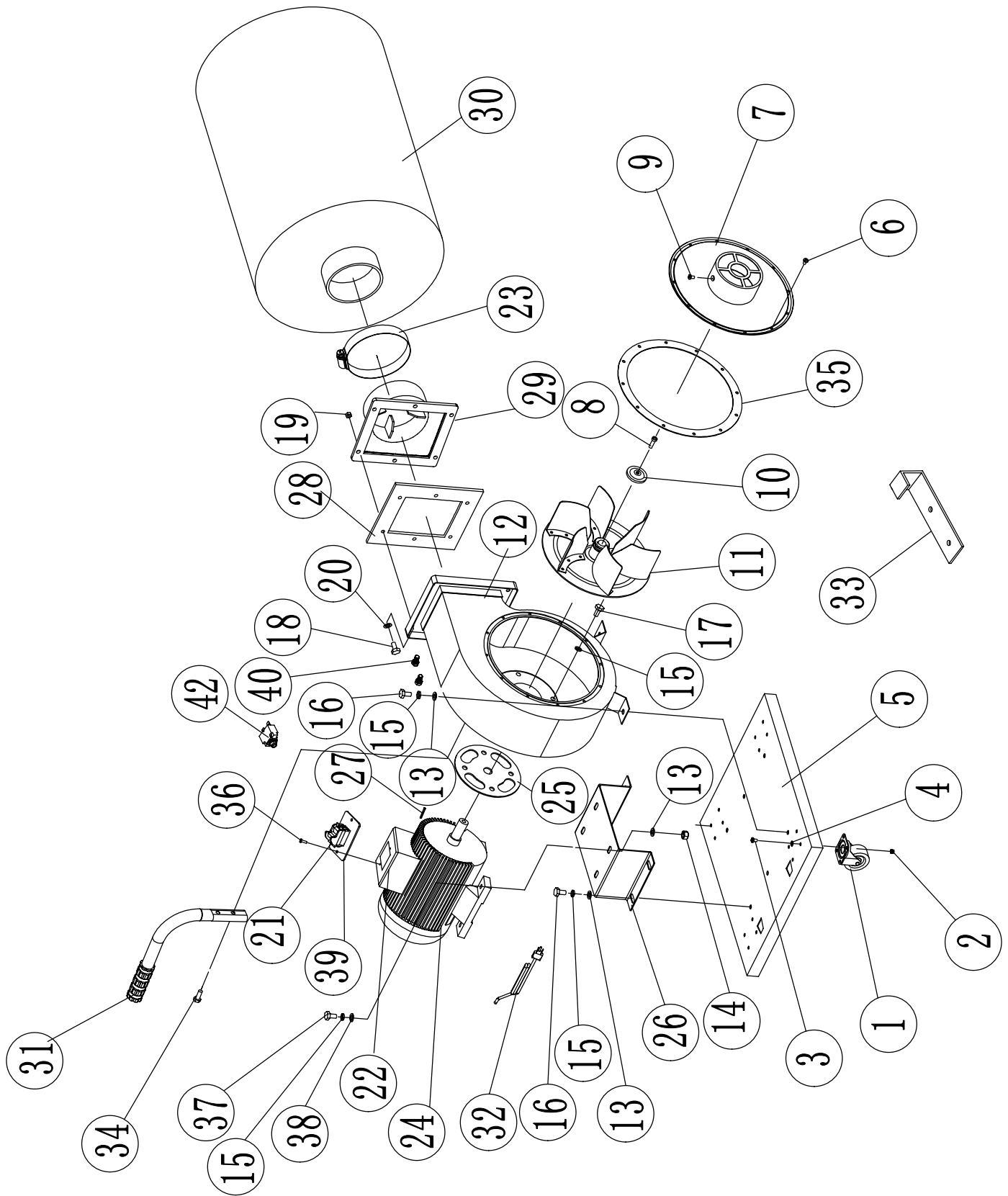

NOTE: Not all parts may be available for purchase. Parts and accessories that wear down over the course of normal use are not covered under the warranty.

EXPLODED VIEW & PARTS LIST

No.	Part No.	Description	Qty.	No.	Part No.	Description	Qty.
1	DC3402-001	Caster	4	21	3401-035	Switch	1
2		Lock Nut, M5	16	22	3403-046	Switch Box	1
3		Pan Head Screw, M5x10	16	23		Hose Clamp	1
4		Washer, 5mm	16	24	DC3402-024	Motor	1
5		Base Plate	1	N.P.		Capacitor, 125V, 200uF	1
6		Pan Head Screw, M5x8	12	25		Spacer	1
7		Inlet Cover	1	26		Motor Mount	1
8		Socket Head Cap Screw, M6x20	1	27		Motor Key, 5x5x25	1
9		Pan Head Screw, M5x8	1	28	DC3402-028	Outlet Gasket	1
10		Washer	1	29		Outlet	1
11		Impeller	1	30	DC3402-030	Collector Bag	1
12		Collector Body	1	31		Handle	1
13		Washer, 8mm	10	32		Power Cord	1
14		Nut, M8	4	33	DC3402-033	Wall Bracket	2
15		Lock Washer, 8mm	14	34		Hex Head Screw, M6x20	2
16		Hex Head Screw, M8x12	6	35	DC3402-035	Inlet Gasket	1
17		Hex Head Screw, M8x16	4	36		Self-Tapping Screw, ST4x12	2
18		Hex Head Screw, M6x20	6	37		Hex Head Screw, M8x20	4
19		Nut, M6	6	38		Washer, 8mm	4
20		Washer, 6mm	6	39		Switch Plate	1
				40		Hex Head Screw, M8x16	2
				42	DC3402-042	Breaker, 9A	1

NOTE: Not all parts may be available for purchase. Parts and accessories that wear down over the course of normal use are not covered under the warranty.

WARRANTY STATEMENT

WEN Products is committed to building tools that are dependable for years. Our warranties are consistent with this commitment and our dedication to quality.

LIMITED WARRANTY OF WEN PRODUCTS FOR HOME USE

GREAT LAKES TECHNOLOGIES, LLC (“Seller”) warrants to the original purchaser only, that all WEN consumer power tools will be free from defects in material or workmanship during personal use for a period of two (2) years from date of purchase or 500 hours of use; whichever comes first. Ninety days for all WEN products if the tool is used for professional or commercial use. Purchaser has 30 days from the date of purchase to report missing or damaged parts.

SELLER’S SOLE OBLIGATION AND YOUR EXCLUSIVE REMEDY under this Limited Warranty and, to the extent permitted by law, any warranty or condition implied by law, shall be the replacement of parts, without charge, which are defective in material or workmanship and which have not been subjected to misuse, alteration, careless handling, misrepair, abuse, neglect, normal wear and tear, improper maintenance, or other conditions adversely affecting the Product or the component of the Product, whether by accident or intentionally, by persons other than Seller. To make a claim under this Limited Warranty, you must make sure to keep a copy of your proof of purchase that clearly defines the Date of Purchase (month and year) and the Place of Purchase. Place of Purchase must be a direct vendor of Great Lakes Technologies, LLC. Purchasing through third party vendors, including but not limited to garage sales, pawn shops, resale shops, or any other secondhand merchant, voids the warranty included with this product. Contact techsupport@wenproducts.com or 1-800-232-1195 with the following information to make arrangements: your shipping address, phone number, serial number, required part numbers, and proof of purchase. Damaged or defective parts and products may need to be sent to WEN before the replacements can be shipped out.

Upon the confirmation of a WEN representative, your product may qualify for repairs and service work. When returning a product for warranty service, the shipping charges must be prepaid by the purchaser. The product must be shipped in its original container (or an equivalent), properly packed to withstand the hazards of shipment. The product must be fully insured with a copy of the proof of purchase enclosed. There must also be a description of the problem in order to help our repairs department diagnose and fix the issue. Repairs will be made and the product will be returned and shipped back to the purchaser at no charge for addresses within the contiguous United States.

THIS LIMITED WARRANTY DOES NOT APPLY TO ITEMS THAT WEAR OUT FROM REGULAR USAGE OVER TIME, INCLUDING BELTS, BRUSHES, BLADES, BATTERIES, ETC. ANY IMPLIED WARRANTIES SHALL BE LIMITED IN DURATION TO TWO (2) YEARS FROM DATE OF PURCHASE. SOME STATES IN THE U.S. AND SOME CANADIAN PROVINCES DO NOT ALLOW LIMITATIONS ON HOW LONG AN IMPLIED WARRANTY LASTS, SO THE ABOVE LIMITATION MAY NOT APPLY TO YOU.

IN NO EVENT SHALL SELLER BE LIABLE FOR ANY INCIDENTAL OR CONSEQUENTIAL DAMAGES (INCLUDING BUT NOT LIMITED TO LIABILITY FOR LOSS OF PROFITS) ARISING FROM THE SALE OR USE OF THIS PRODUCT. SOME STATES IN THE U.S. AND SOME CANADIAN PROVINCES DO NOT ALLOW THE EXCLUSION OR LIMITATION OF INCIDENTAL OR CONSEQUENTIAL DAMAGES, SO THE ABOVE LIMITATION OR EXCLUSION MAY NOT APPLY TO YOU.

THIS LIMITED WARRANTY GIVES YOU SPECIFIC LEGAL RIGHTS, AND YOU MAY ALSO HAVE OTHER RIGHTS WHICH VARY FROM STATE TO STATE IN THE U.S., PROVINCE TO PROVINCE IN CANADA AND FROM COUNTRY TO COUNTRY.

THIS LIMITED WARRANTY APPLIES ONLY TO ITEMS SOLD WITHIN THE UNITED STATES OF AMERICA, CANADA AND THE COMMONWEALTH OF PUERTO RICO. FOR WARRANTY COVERAGE WITHIN OTHER COUNTRIES, CONTACT THE WEN CUSTOMER SUPPORT LINE. FOR WARRANTY PARTS OR PRODUCTS REPAIRED UNDER WARRANTY SHIPPING TO ADDRESSES OUTSIDE OF THE CONTIGUOUS UNITED STATES, ADDITIONAL SHIPPING CHARGES MAY APPLY.

**THANKS FOR
REMEMBERING**

