

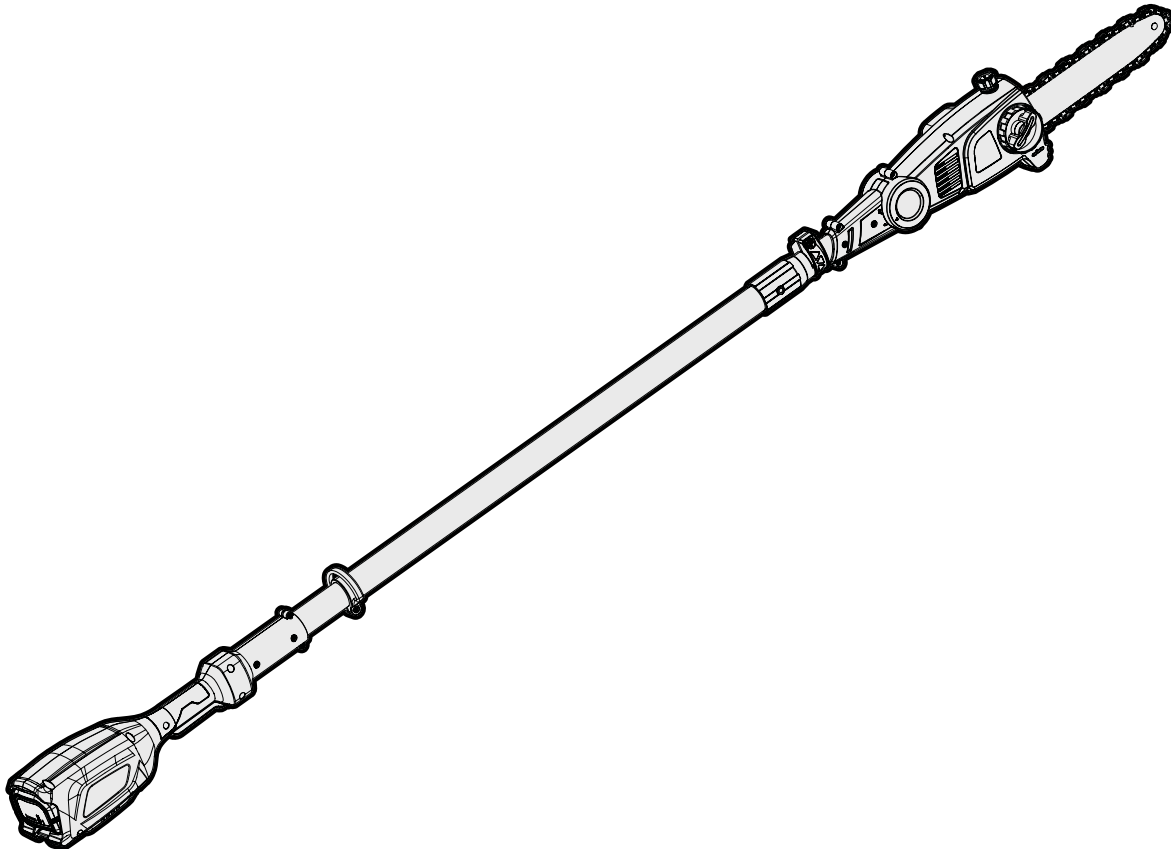

**MODEL 40421, 40421BT**

# **40V MAX LITHIUM ION CORDLESS POLE SAW**

**Instruction Manual**



## **NEED HELP? CONTACT US!**

Have product questions? Need technical support? Please feel free to contact us:



**1-800-232-1195 (M-F 8AM-5PM CST)**



**TECHSUPPORT@WENPRODUCTS.COM**

**IMPORTANT:** Your new tool has been engineered and manufactured to WEN's highest standards for dependability, ease of operation, and operator safety. When properly cared for, this product will supply you years of rugged, trouble-free performance. Pay close attention to the rules for safe operation, warnings, and cautions. If you use your tool properly and for its intended purpose, you will enjoy years of safe, reliable service.

For replacement parts and the most up-to-date instruction manuals, visit **WENPRODUCTS.COM**

# CONTENTS

<b>WELCOME</b>	<b>3</b>
Introduction .....	3
Specifications.....	3
<b>SAFETY</b>	<b>4</b>
General Safety Rules .....	4
Specific Rules for Pole Saws .....	6
Specific Rules for the Battery & Charger.....	8
About the Battery .....	10
About the Charger .....	11
Electrical Information .....	12
<b>BEFORE OPERATING</b>	<b>13</b>
Know Your Pole Saw .....	13
Assembly & Adjustment.....	14
<b>OPERATION &amp; MAINTENANCE</b>	<b>17</b>
Operation .....	17
Maintenance.....	19
Storage .....	20
Exploded View & Parts List.....	21
Warranty Statement .....	24

# INTRODUCTION

Thanks for purchasing the WEN Pole Saw. We know you are excited to put your tool to work, but first, please take a moment to read through the manual. Safe operation of this tool requires that you read and understand this operator's manual and all the labels affixed to the tool. This manual provides information regarding potential safety concerns, as well as helpful assembly and operating instructions for your tool.

**⚠ SAFETY ALERT SYMBOL:** Indicates danger, warning, or caution. The safety symbols and the explanations with them deserve your careful attention and understanding. Always follow the safety precautions to reduce the risk of fire, electric shock or personal injury. However, please note that these instructions and warnings are not substitutes for proper accident prevention measures.

**NOTE:** The following safety information is not meant to cover all possible conditions and situations that may occur. WEN reserves the right to change this product and specifications at any time without prior notice.

At WEN, we are continuously improving our products. If you find that your tool does not exactly match this manual, please visit [wenproducts.com](http://wenproducts.com) for the most up-to-date manual or contact our customer service at **1-800-232-1195**.

**Keep this manual available to all users during the entire life of the tool and review it frequently to maximize safety for both yourself and others.**

# SPECIFICATIONS

Model Number	40421, 40421BT	
Motor	40V Brushless Motor	
Guide Bar	10 inch	
Speed (no-load)	4800 RPM	
Maximum Reach	10 feet	
Oil Tank Capacity	3.4 ounces	
Saw Chain Model	91PJ040X	
Guide Bar Model	100SDEA041	
Chain Pitch	3/8 inch	
Chain Gauge	1/2 inch	
Drive Links	40	
Battery	40V Max Lithium Ion, 2Ah	
Charger Input	100-120V AC, 60Hz, 100W	
Charger Output	42V DC, 2A	
Battery Model	40401	
Charger Model	40400C	
Weight with Battery	12 pounds	
Product Dimensions	Extended	111 x 5.1 x 6.3 inches
	Shortened	77 x 5.1 x 6.3 inches

**NOTE:** Model 40421BT does not include battery or charger.

# GENERAL SAFETY RULES

**Safety is a combination of common sense, staying alert and knowing how your item works.  
SAVE THESE SAFETY INSTRUCTIONS.**

 **WARNING:** Read and understand all warnings, cautions and operating instructions before using this tool. Failure to follow all instructions listed below may result in personal injury and tool damage.

## WORK AREA SAFETY

1. Keep work area clean and well lit. Cluttered or dark areas invite accidents.
2. Do not operate power tools in explosive atmospheres, such as in the presence of flammable liquids, gases or dust. Power tools create sparks which may ignite the dust or fumes.
3. Do not expose power tools to rain or wet conditions. Water entering a power tool will increase the risk of electric shock.
4. Keep children and bystanders away while operating a power tool. Distractions can cause you to lose control.

## ELECTRICAL SAFETY

1. Power tool plugs must match the outlet. Never modify the plug in any way. Do not use any adapter plugs with earthed (grounded) power tools. Unmodified plugs and matching outlets will reduce risk of electric shock.
2. Avoid body contact with earthed or grounded surfaces such as pipes, radiators, ranges and refrigerators. There is an increased risk of electric shock if your body is earthed or grounded.
3. Do not abuse the cord. Never use the cord for carrying, pulling or unplugging the power tool. Keep cord away from heat, oil, sharp edges or moving parts. Damaged or entangled cords increase the risk of electric shock.
4. If operating a power tool in a damp location is unavoidable, use a ground fault circuit interrupter (GFCI) protected supply. Use of a GFCI reduces the risk of electric shock.

## PERSONAL SAFETY

1. Stay alert, watch what you are doing and use common sense when operating a power tool. Do not use a power tool while you are tired or under the influence of drugs, alcohol or medication. A moment of inattention while operating power tools may result in serious personal injury.
2. Use personal protective equipment. Always wear eye protection. Protective equipment such as a dust mask, non-skid safety shoes and hearing protection used for appropriate conditions will reduce the risk of personal injury.
3. Dress properly. Do not wear loose clothing or jewelry. Keep your hair and clothing away from moving parts. Loose clothes, jewelry or long hair can be caught in moving parts.
4. Remove any adjusting key or wrench before turning the power tool on. A wrench or a key left attached to a rotating part of the power tool may result in personal injury.

# GENERAL SAFETY RULES

5. Prevent unintentional starting. Ensure the switch is in the off-position before connecting to power source and/or battery pack, picking up or carrying the tool. Carrying power tools with your finger on the switch or energizing power tools that have the switch on invites accidents.
6. Do not overreach. Keep proper footing and balance at all times. This enables better control of the power tool in unexpected situations.
7. If devices are provided for the connection of dust extraction and collection facilities, ensure these are connected and properly used. Use of dust collection can reduce dust-related hazards.

## POWER TOOL USE AND CARE

1. Do not force the power tool. Use the correct power tool for your application. The correct power tool will do the job better and safer at the rate for which it was designed.
2. Do not use the power tool if the switch does not turn it on and off. Any power tool that cannot be controlled with the switch is dangerous and must be repaired.
3. Disconnect the plug from the power source and/or the battery pack from the power tool before making any adjustments, changing accessories, or storing power tools. Such preventive safety measures reduce the risk of starting the power tool accidentally.
4. Store idle power tools indoors and out of the reach of children and do not allow persons unfamiliar with the power tool or these instructions to operate the power tool. Power tools are dangerous in the hands of untrained users.
5. Maintain power tools. Check for misalignment or binding of moving parts, breakage of parts and any other condition that may affect the power tool's operation. If damaged, have the power tool repaired before use. Many accidents are caused by poorly maintained power tools.
6. Use the power tool, accessories and tool bits etc. in accordance with these instructions, taking into account the working conditions and the work to be performed. Use of the power tool for operations different from those intended could result in a hazardous situation.

## BATTERY USE AND CARE

1. Recharge only with the charger specified by the manufacturer. A charger that is suitable for one type of battery pack may create a risk of fire when used with another battery pack.
2. Use power tools only with specifically designated battery packs. Use of any other battery packs may create a risk of injury and fire.
3. When battery pack is not in use, keep it away from other metal objects, like paper clips, coins, keys, nails, screws or other small metal objects, that can make a connection from one terminal to another. Shorting the battery terminals together may cause burns or a fire.
4. Under abusive conditions, liquid may be ejected from the battery; avoid contact. If contact accidentally occurs, flush with water. If liquid contacts eyes, additionally seek medical help. Liquid ejected from the battery may cause irritation or burns.

## SERVICE

Have your power tool serviced by a qualified repair person using only identical replacement parts. This will ensure that the safety of the power tool is maintained.

## SPECIFIC SAFETY RULES FOR POLE SAWS

 **WARNING:** Do not let comfort or familiarity with the product replace strict adherence to product safety rules. Failure to follow the safety instructions may result in serious personal injury.

 **WARNING:** Do not operate near electrical power lines. The pole saw has not been designed to provide protection from electric shock from contact with power lines. Contact with or use near power lines may cause serious injury, electric shock, or death.

1. **TOOL PURPOSE.** The purpose of this pole saw is for limbing trees and cleaning up branches. Do not push it beyond its limits or its capacities. Using the pole saw in a way for which it was not designed can result in serious injuries, machine damage and voiding of the warranty. Only use with WEN 40V Max Lithium Ion battery 40401.
2. Hold the pole saw by the insulated gripping surfaces only. If the pole saw contacts a live wire, the exposed metal parts of the pole saw may become live and could cause electric shock. Hold the pole saw with two hands to avoid loss of control.
3. Keep all parts of the body away from the saw chain. The saw chain continues to move after the switch is turned off. Allow the saw chain to completely stop before clearing jammed material.
4. Keep bystanders, especially children, at a safe distance away from the saw during operation.
5. Wear eye and hearing protection. Other personal protection equipment for the head, hands, legs and feet is recommended especially when using the pole saw overhead. Falling debris can result in serious injury.
6. Do not operate the saw while sitting or standing in a tree. Maintain a safe, secure stance at all times. Only use the saw when standing on solid, safe and level ground.
7. Use particular caution when cutting brush and young trees. The thin material may get caught in the chain and hit you or throw you off balance.
8. Carry the switched-off pole saw using the handle with the chain pointing away from your body. Always put on the protective cover when transporting or storing the pole saw. Carefully handling the saw greatly reduces the risk of accidentally touching the sharp cutting chain.
9. Keep the handles dry, clean and free from gas, oil and grease. Slippery handles may lead to a loss of control.
10. Remain alert; pay attention to what you are doing and proceed sensibly when working with an electric tool. Do not use the machine if you are tired or under the influence of drugs, alcohol or medication.
11. Inspect the saw thoroughly before use for damage. If any parts or pieces appear to be missing or damaged, do not operate the saw.
12. Do not operate during adverse weather conditions, particularly during lightening and rain. This decreases the risk of being struck by lightning.

## SPECIFIC SAFETY RULES FOR POLE SAWS

 **WARNING:** To reduce the risk of electric shock, always unplug the charger before performing any cleaning or maintenance. Do not allow water to flow into the charger. Use a Ground Fault Circuit Interrupter (GFCI) to reduce shock hazards.

13. Sawing wood under tension necessitates an increased amount of caution. Wood that is suddenly released from tension can react in a completely uncontrolled manner. This can result in severe to deadly injuries. Such work may only be performed by trained specialists.

14. To reduce the risk of electrocution, never use near any electrical power lines. Contact with or use near power lines may cause serious injury or electric shock resulting in death.

15. Always use two hands when operating the pole saw. Hold the pole saw with both hands to avoid loss of control.

16. This tool is not intended for use by persons (including children) with reduced physical, sensory or mental capabilities, or lack of experience and knowledge, unless they have been given supervision or instruction concerning use of the appliance by a person responsible for their safety. Children should be supervised to ensure that they do not play with the appliance.

17. Wait until the chain has come to a standstill completely before placing it down.

18. Any servicing should be performed by an authorized service representative. If you need assistance, **contact WEN customer service at 1-800-232-1195.**

### REDUCING KICKBACK

Kickback can occur when the tip of the guide bar touches an object or when the wood closes in and pinches the saw chain inside of the cut. Tip contact can kick the guide bar up and back towards the operator. Pinching the saw chain along the top of the guide bar can push the bar rapidly towards the operator. Either of these reactions may cause a loss in control of the pole saw, increasing the chances of serious personal injury. Do not rely on the safety devices built into the saw. Pole saw users should take as many precautions as possible to minimize on-site accidents. Kickback is the result of tool misuse and/or incorrect operating procedures. These conditions can be minimized with the following steps:

1. Maintain a firm grip, with thumbs and fingers encircling the pole saw handle. Both hands should be on the saw with your body and arms in a position to resist kickback forces. Kickback forces can be controlled by the operator, if proper precautions are taken. Do not let go of the pole saw.

2. Do not overreach and do not cut above shoulder height. This helps prevent unintended tip contact and enables better control of the pole saw in unexpected situations.

3. Only use replacement bars and chains specified by WEN. Incorrect replacement bars and chains may cause chain breakage and/or kickback.

4. Follow the manufacturer's sharpening and maintenance instructions for the pole saw. Decreasing the depth gauge height can lead to increased kickback.

## SPECIFIC SAFETY RULES FOR THE BATTERY & CHARGER

 **WARNING:** Do not let comfort or familiarity with the product replace strict adherence to product safety rules. Failure to follow the safety instructions may result in serious personal injury.

Despite all the safety precautions, caution must always be exercised when handling batteries. The following points must be obeyed at all times to ensure safe use. Safe use can only be guaranteed if undamaged cells are used. Incorrect handling of the battery pack can cause cell damage.

1. **TOOL PURPOSE.** This charger is designed for recharging WEN 40V Max Lithium Ion batteries (model numbers 40401 and 40404). Charging any other battery or using a different charger to charge these batteries could result in fire, injury, or damage. Using the charger for any other purpose for which it is not designed may result in serious injuries, machine damage and voiding of the warranty.

2. **AVOID DANGEROUS ENVIRONMENTS.** Do not charge the battery pack in rain, snow or in damp or wet locations. Do not use the battery pack or charger in the presence of explosive atmospheres (gaseous fumes, dust or flammable materials) because sparks may be generated when inserting or removing the battery pack, which could lead to a fire.

3. **CHARGE IN A WELL-VENTILATED AREA.** Do not block the charger vents. Keep them clear to allow for proper ventilation. Do not allow smoking or open flames near a charging battery pack. Vented gases may explode.

**NOTE:** The safe temperature range for charging the battery is 50°F to 104°F. Do not charge the battery outside in freezing weather; charge it at room temperature.

4. **MAINTAIN CHARGER CORD.** When unplugging the charger, pull the plug, not the cord, from the receptacle to reduce the risk of damage to the electrical plug and cord. Never carry the charger by its cord or yank it by the cord to disconnect it from the receptacle. Keep the cord away from heat, oil and sharp edges. Make sure the cord will not be stepped on, tripped over or subjected to damage or stress when the charger is in use. Do not use the charger with a damaged cord or plug. Replace a damaged charger immediately.

5. **DO NOT USE AN EXTENSION CORD UNLESS IT IS ABSOLUTELY NECESSARY.** Using the wrong, damaged or improperly wired extension cord poses a risk of fire and electric shock. If an extension cord must be used, plug the charger into a properly-wired 16AWG or larger extension cord with the female plug matching the male plug on the charger. Make sure that the extension cord is in good electrical condition.

6. **CHARGER IS RATED FOR 120V, 60Hz AC ONLY.** The charger must be plugged into an appropriate receptacle.

7. **USE ONLY RECOMMENDED ATTACHMENTS.** Use of an attachment not recommended or sold by WEN Products may result in risk of fire, electric shock or personal injury.



## SPECIFIC SAFETY RULES FOR THE BATTERY & CHARGER

 **WARNING:** To reduce the risk of electric shock, always unplug the charger before performing any cleaning or maintenance. Do not allow water to flow into the charger. Use a Ground Fault Circuit Interrupter (GFCI) to reduce shock hazards.

8. **UNPLUG CHARGER WHEN NOT IN USE.** Make sure to remove battery packs from unplugged chargers.

9. **DO NOT BURN OR INCINERATE BATTERY PACKS.** Battery packs may explode, causing personal injury or damage. Toxic fumes and materials are created when battery packs are burned.

10. **DO NOT CRUSH, DROP OR DAMAGE BATTERY PACKS.** Do not use the battery pack or charger if they have sustained a sharp blow, been dropped, run over or have been damaged in any way (e.g. pierced with a nail, hit with a hammer, stepped on, etc.).

11. **DO NOT DISASSEMBLE.** Incorrect reassembly may pose a serious risk of electric shock, fire or exposure to toxic battery chemicals. If the battery or charger are damaged, call WEN customer service at 1-800-232-1195 for assistance.

12. **BATTERY CHEMICALS CAUSE SERIOUS BURNS.** Never let a damaged battery pack contact the skin, eyes or mouth. If a damaged battery pack leaks battery chemicals, use rubber or neoprene gloves to safely dispose of it. If skin is exposed to battery fluids, wash the affected area with soap and water and rinse with vinegar. If eyes are exposed to battery chemicals, immediately flush with water for 20 minutes and seek medical attention. Remove and dispose of contaminated clothing.

13. **DO NOT SHORT CIRCUIT.** A battery pack will short circuit if a metal object makes a connection between the positive and negative contacts on the battery pack. Do not place a battery pack near anything that may cause a short circuit, such as paper clips, coins, keys, screws, nails and other metallic objects. A short-circuited battery pack poses a risk of fire and severe personal injury.

14. **STORE YOUR BATTERY PACK AND CHARGER IN A COOL, DRY PLACE.** Do not store the battery pack or charger where temperatures may exceed 104°F, such as in direct sunlight or inside a vehicle or metal building during the summer.

15. **ALWAYS REMOVE THE BATTERY PACK FROM THE TOOL AFTER USE.** Before assembling, adjusting, cleaning, or storing the pole saw, you must remove the battery pack.

## ABOUT THE BATTERY

 **WARNING:** Waste electrical products should not be disposed of with household waste. Please recycle where facilities exist. Check with your local authority or retailer for recycling advice.

 **WARNING:** To reduce risk of injury, charge only WEN batteries with this charger. Other types of batteries may burst causing personal injury and damage.

### ABOUT THE BATTERY

1. The battery pack supplied with your cordless tool is only partially charged. The battery pack has to be charged completely before you use the tool for the first time.
2. For optimum battery performance, avoid low discharge cycles by charging the battery pack frequently.
3. Lithium-ion batteries are subject to a natural aging process. The battery pack must be replaced at the latest when its capacity falls to just 80% of its capacity when new. Weakened cells in an aged battery pack are no longer capable of meeting the high power requirements needed for the proper operation of your tool, and therefore pose a safety risk.
4. Do not throw battery packs into an open fire as this poses a risk of explosion. Do not ignite the battery pack or expose it to fire.
5. Do not exhaustively discharge batteries. Exhaustive discharge will damage the battery cells. The most common cause of exhaustive discharge is lengthy storage or non-use of partially discharged batteries. Stop working as soon as the performance of the battery falls noticeably or the electronic protection system triggers. Place the battery pack in storage only after it has been fully charged.
6. Protect batteries and the tool from overloads. Overloads will quickly result in overheating and cell damage inside the battery housing even if this overheating is not apparent externally.
7. Avoid damage and shocks. Immediately replace batteries that have been dropped from a height of more than one meter or those that have been exposed to violent shocks, even if the housing of the battery pack appears to be undamaged. The battery cells inside the battery may have suffered serious damage. In such instances, please read the waste disposal information for proper battery disposal.
8. If the battery pack suffers overloading and overheating, the integrated protective cutoff will switch off the equipment for safety reasons.
9. Use only original battery packs. The use of other batteries poses a fire risk and may result in injuries or an explosion.
10. You must fully charge the battery every 3 months. See the tables on pages 13 & 14 to understand what the LED lights on your battery and charger indicate.

## ABOUT THE CHARGER

 **WARNING:** Waste electrical products should not be disposed of with household waste. Please recycle where facilities exist. Check with your local authority or retailer for recycling advice.

 **WARNING:** To reduce risk of injury, charge only WEN batteries with this charger. Other types of batteries may burst causing personal injury and damage.

### ABOUT THE CHARGER

Protect the battery charger and its cord from damage. Keep the charger and its cord away from heat, oil and sharp edges. Electrical plugs must match the outlet. Never modify the plug in any way. Do not use any adapter plugs with grounded appliances. Unmodified plugs and matching outlets will reduce the risk of electric shock.

Keep the battery charger, battery pack(s) and the cordless tool out of the reach of children. Do not use the supplied battery charger to charge other cordless tools. During periods of heavy use, the battery pack will become warm. Allow the battery pack to cool to room temperature before inserting it into the charger to recharge.

Do not overcharge batteries. Do not exceed the maximum charging times. These charging times only apply to discharged batteries. Frequent insertion of a charged or partially charged battery pack will result in overcharging and cell damage. Do not leave battery in the charger for days on end. Never use or charge a battery if you suspect that it has been more than 12 months since the last time they were charged. There is a high probability that the battery pack has already suffered dangerous damage (exhaustive discharge). Do not use battery that have been exposed to heat during the charging process, as the battery cells may have suffered dangerous damage. Do not use battery that have suffered curvature or deformation during the charging process or those that exhibit other atypical symptoms (gassing, hissing, cracking, etc.)

# ELECTRICAL INFORMATION

1. **POLARIZED PLUGS.** To reduce the risk of electric shock, this equipment has a polarized plug (one blade is wider than the other). This plug will fit in a polarized outlet only one way. If the plug does not fit fully in the outlet, reverse the plug. If it still does not fit, contact a qualified electrician to install a proper outlet. Do not modify the machine plug or the extension cord in any way.
2. **GROUND FAULT CIRCUIT INTERRUPTER PROTECTION (GFCI)** should be provided on the circuit or outlet used for this power tool to reduce the risk of electric shock.
3. **SERVICE AND REPAIR.** To avoid danger, electrical appliances must only be repaired by qualified service technician using original replacement parts.

## GUIDELINES AND RECOMMENDATIONS FOR EXTENSION CORDS

When using an extension cord, be sure to use one heavy enough to carry the current your product will draw. An undersized cord will cause a drop in line voltage resulting in loss of power and overheating. The table below shows the correct size to be used according to cord length and ampere rating. When in doubt, use a heavier cord. The smaller the gauge number, the heavier the cord.

AMPERAGE	REQUIRED GAUGE FOR EXTENSION CORDS			
	25 ft.	50 ft.	100 ft.	150 ft.
2.5A	18 gauge	16 gauge	14 gauge	12 gauge

1. **EXAMINE EXTENSION CORD BEFORE USE.** Make sure your extension cord is properly wired and in good condition. Always replace a damaged extension cord or have it repaired by a qualified person before using it.
2. **DO NOT ABUSE EXTENSION CORD.** Do not pull on cord to disconnect from receptacle; always disconnect by pulling on plug. Disconnect the extension cord from the receptacle before disconnecting the product from the extension cord. Protect your extension cords from sharp objects, excessive heat and damp/wet areas.
3. **USE A SEPARATE ELECTRICAL CIRCUIT FOR YOUR TOOL.** This circuit must not be less than a 12-gauge wire and should be protected with a 15A time-delayed fuse. Before connecting the motor to the power line, make sure the switch is in the OFF position and the electric current is rated the same as the current stamped on the motor nameplate. Running at a lower voltage will damage the motor.

# KNOW YOUR POLE SAW

## TOOL PURPOSE

This pole saw is designed for limbing trees and cleaning up branches. Refer to the diagram below to become familiarized with the parts and controls of your 40V Max Lithium Ion Cordless Pole Saw.

**⚠ WARNING:** When handling saw chains, always wear protective gloves.

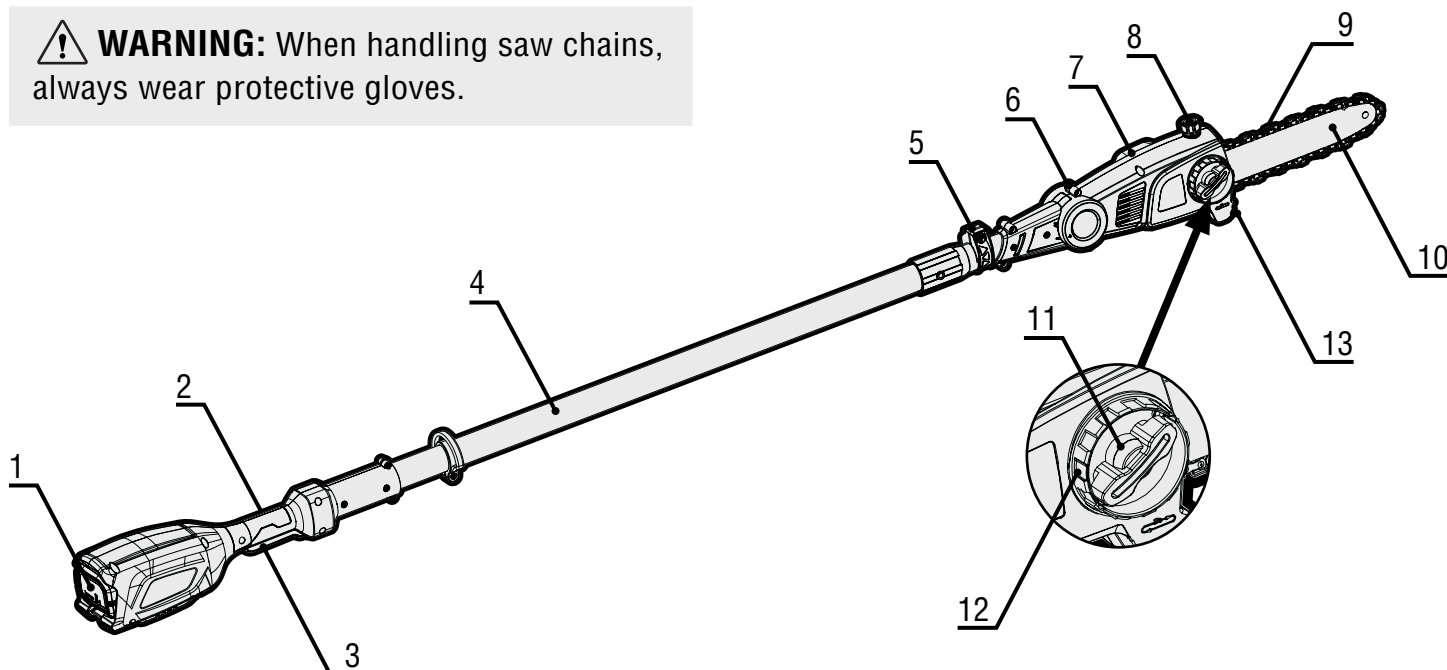

1	Battery Compartment
2	Safety Switch*
3	Trigger
4	Pole
5	Telescoping Release Clasp

6	Angle Adjustment Button*
7	Motor Housing
8	Oil Tank Cover
9	Saw Chain
10	Guide Bar

11	Cover Release Knob
12	Tension Adjustment Knob
13	Stop Face (Ridges)

\* Located on the left side of the saw

Red Light	Green Light	Status	Charger LED Light Details
On	Off	Standby	The battery is not connected and charger is in standby mode.
On	Flashing	Charging	The battery is charging.
Off	On	Fully Charged	The battery is fully charged and should be removed from the charger.
Flashing	Off	Error	There is a problem with the battery. Contact customer service at 1-800-232-1195 for assistance in replacing the battery.
Flashing	Flashing	Temperature Error	The temperature is either too high or too low. If the battery is warm, remove it from the charger for a few minutes to let it cool down. Once the temperature returns to the normal temperature range (50°F - 104°F), you can continue charging the battery.

Table A

# ASSEMBLY AND ADJUSTMENTS

**⚠ WARNING:** Do not plug in or turn on the tool until it is fully assembled according to the instructions. Failure to follow the safety instructions may result in serious personal injury.

## FILLING THE AUTO OIL SYSTEM

This pole saw features an auto-oiling system to keep the chain and guide bar properly lubricated. The oil level indicator shows the remaining oil in the pole saw. If the oil level decreases to below one quarter capacity, refill it with the proper bar and chain oil. To fill the oil reservoir:

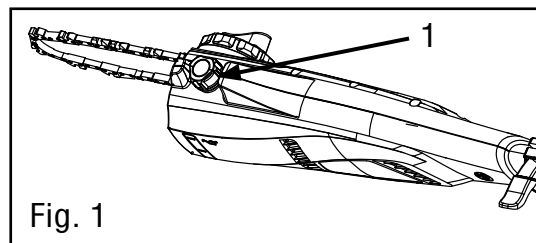

1. Place the saw on a level surface. Clean the area around the oil tank cap and then open it.
2. Fill the oil tank (Fig. 1 - 1) with saw chain oil. In doing so, make sure that no dirt gets into the oil tank so that the oil nozzle does not clog. Close the oil tank cap.

## REMOVING AND CHARGING THE BATTERY

1. Press the battery release button (located in front of the battery compartment) to release the battery. Slide the battery out of the saw.
2. Slide the battery into the charger. Refer to Tables A (p. 13) & B (below) to understand what the lights on the battery and charger indicate.
3. If using the battery, take the battery off of the charger and place it in your desired WEN tool. If storing the battery, unplug the charger from the power source and leave the battery on the charger.
4. Unplug the charger from the power source when charging is complete. Never leave your charger plugged in if it is not charging a battery.

## ATTACH/REMOVE THE BATTERY

**Note:** The battery is not fully charged at the time of purchase. Before using the pole saw for the first time, place the battery in the charger and charge it fully.

To insert the battery, slide it into the battery compartment until a “click” is heard. Make sure the battery is fully inserted and latched into position. To remove the battery, press the release button and slide the battery out of the pole saw.

Number of Lights On	Battery LED Light Details
All 4	The battery is fully charged and ready for use.
3 - 2	The battery is partially charged.
1 Blinking	The battery is dead and needs to be immediately recharged. If you do not charge the battery right away, the battery's lifetime will be drastically shortened. You should not let your battery go below a 20% charge; this will preserve your battery's life.

Table B

# ASSEMBLY AND ADJUSTMENTS

## ASSEMBLY OF GUIDE BAR AND SAW CHAIN

1. Place the saw body on a firm and level surface.
2. Rotate the cover release knob (Fig. 2 - 1) counter-clockwise to remove the cover from the saw's body.
3. While wearing protective gloves, wrap the saw chain around the guide bar, making sure that the teeth are aimed in the direction of rotation (Fig. 3). The chain should be properly set in the slot running along the entire outside edge of the guide bar.
4. Place the saw chain around the sprocket (Fig. 3 - 1) while lining up the slot in the guide bar with the bolt (Fig. 3 - 2) at the base of the saw and the chain tensioning pin (Fig. 3 - 3) in the guide bar's pin hole. The chain tensioning pin may need adjustment (see next section) to properly align with the hole in the guide bar.
5. While holding the bar still, place the cover back onto the saw. Adjust tension (next section).

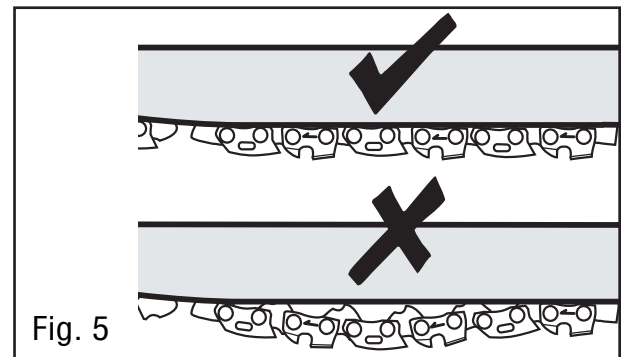
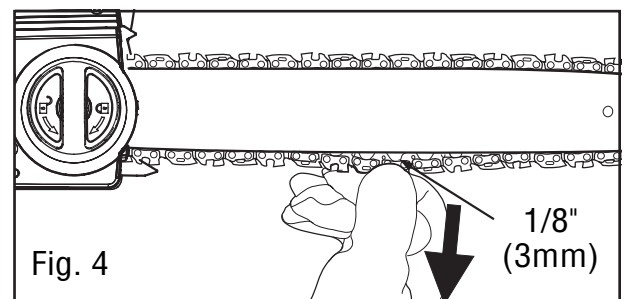
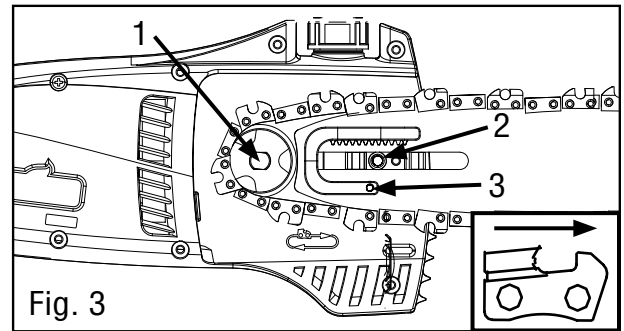
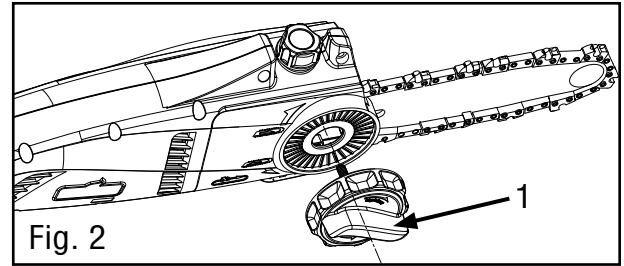

## TENSIONING THE CHAIN

**NOTE:** The saw chain must be tensioned properly in order to ensure safe operation. The chain tension is optimal if the saw chain can be lifted 1/8 inch (3 mm) from the center of the guide bar. Since the saw chain heats up during operation, its length can therefore fluctuate. Check the chain tension every 10 minutes of operation and adjust as necessary, particularly for new saw chains. Slacken the saw chain after the work is completed since it shortens when cooling down. In doing so, you can elongate the chain's life and prevent damage.

1. Check the chain tension by pulling the saw chain away from the guide bar. A properly tensioned chain should have roughly 1/8 inch (3 mm) of distance between itself and the bar guide (Fig. 4).
2. If adjustments are needed, loosen the retaining nut of the chain sprocket cover by a few rotations.
3. To adjust the saw chain tension, rotate the tension adjustment knob (the outermost knob on the cover release knob). Clockwise rotation increases the tension while counter-clockwise rotation decreases tension. A properly tensioned chain should have no sag (Fig. 5) and should only be able to be pulled 1/8 inch (3 mm) away from the guide bar of the saw. Do not over-tension the chain: this will lead to excessive wear and reduces the life of both the bar and chain.

# ASSEMBLY AND ADJUSTMENTS

**⚠ WARNING:** Do not turn on the tool until it is fully assembled according to the instructions. Failure to follow the safety instructions may result in serious personal injury.

**⚠ WARNING:** When handling saw chains, always wear protective gloves to prevent injury.

## SAW CHAIN LUBRICATION

Always remove the battery from the unit before inspection and adjustment work.

Never operate the pole saw without saw chain oil. The use of the pole saw without enough saw chain oil will damage the unit.

Only use special saw chain oil. Other oils will run the risk of damaging the unit and voiding the warranty.

Take note of temperature conditions. Using the saw at various temperatures requires the use of differing oils. To ensure a sufficient layer of lubricant at lower temperatures, use liquid oil (low viscosity).

## ADJUSTING THE TELESCOPING HANDLE

1. Unlock the telescope release lever (Fig. 6 - 1) so that the pole can freely extend outwards and inwards.
2. Extend it to the desired length and lock the telescope release lever to hold it in place.

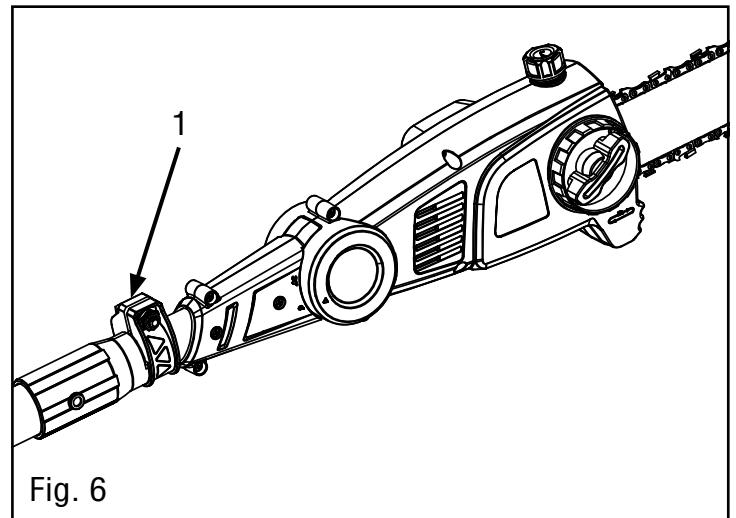



# OPERATION

## PREPARATION

Before each use, check the following items to ensure safe working conditions.

**POLE SAW:** before beginning work, inspect the pole saw for damage to the housing, the saw chain and the guide bar. Never use an obviously damaged machine.

**CHAIN OIL:** check the fill level of the oil tank. Also check whether there is sufficient oil available while working. Never operate the saw if there is no oil or the oil level has dropped below the minimum oil level mark in order to prevent damage to the pole saw. On average, an oil filling is sufficient for approximately 10 minutes of cutting operation (depending the duration of pauses and the density of the workpiece).

**SAW CHAIN:** check the tension of the saw and the condition of the blades. The sharper the saw chain is, the easier and more manageable operations will be. The same applies to chain tension. Check the tension every 10 minutes of operation to maximize safety. New saw chains in particular are subject to changes due to the heat created by operation. Never allow the saw chain to contact dirt or soil.

**PROTECTIVE CLOTHING:** make absolutely sure to wear the appropriate close-fitting protective clothing such as protective pants, gloves and safety shoes. Wear a safety helmet with integrated hearing protection and a face guard to provide protection against falling and recoiling branches.

## SAFETY WARNINGS

1. In order to ensure safe work, do not operate the saw at an angle of over 60 degrees.
2. Never stand below a branch that is being sawed.
3. Exercise caution when sawing branches under tension or branches that are splintering.
4. Make sure to safeguard against the risk of injury from falling branches and flying wood projectiles.
5. If the machine is operating, keep people and animals away from the area.
6. The machine is not protected against electric shock when coming into contact with high-voltage lines. Maintain a minimum clearance of 30 feet from current-carrying power lines to avoid life-threatening electric shock.
7. When working on an incline, always stand above or to the side of the branch being sawed.
8. Allow the chain to cut for you. Keep the saw running at full speed for the entire duration of the cut.

## PREVENTING KICKBACK

The term kickback refers to when the saw suddenly jumps up and back. This is usually caused by the workpiece coming into contact with the guide bar tip or the clamping of the saw chain.

A kickback generates an abrupt powerful force. The saw usually reacts in an uncontrolled manner, creating the possibility of injury to the user.

The danger of a kickback is greatest when attempting to cut near or with the guide bar tip. Always apply the saw as flatly as possible in order avoid a loss of control during operation.

# OPERATION

 **WARNING:** Do not cut down trees in high wind conditions. This can result in injury and should only be performed by a trained professional.

## ON/OFF SWITCH

**To turn the tool ON:** press the safety button (located on the left-hand side of the rear handle, above the power trigger) and then squeeze the power trigger. After the tool has started, you can release the safety switch without turning the tool off.

**To turn the tool OFF:** release the power trigger. Always remove the battery from the pole saw when finished.

## HEAD ADJUSTMENT

The angle of the saw's head can be adjusted anywhere from 0 to 30 degrees by pushing down on the Angle Adjustment Button (page 13). If you would like to change the angle of the saw's head, first remove the battery and then adjust to the desired angle.

## SAWING TECHNIQUES

When removing branches, hold the pole saw at an angle ranging from 0 to 60° in order to avoid being struck by a falling branch. The saw should never be operated directly above anyone's head.

Saw off the lower branches on the tree first. By doing so, it is easier for the cut branches to fall to the ground.

At the end of the cut, the weight of the saw suddenly increases for the user since it is no longer being supported by a branch. There is a risk of losing control of the saw, so make sure to stay alert during the entire sawing operation.

Only pull the saw out of a cut while the saw is running. By doing so, you prevent the chain from jamming in the wood.

Do not saw with the tip of the guide bar. Do not saw into the branch formations (where the tree branches outwards). This will impede the tree's ability to heal.

For sawing off smaller branches, place the stop face (p. 13 - callout 13) of the saw on the branch. This prevents unwanted movements of the saw at the beginning of the cut. While applying light pressure, guide the saw through the branch from top to bottom.

For sawing off larger branches, first make a relief cut. Saw through 1/3 of the branch diameter from the bottom to top using the top side of the guide bar. Then saw from top to bottom for the other 2/3 using the bottom side of the guide bar. Saw off longer branches in sections in order to maintain control over the location of impact.

**NOTE:** Never allow the saw chain to contact dirt or soil, doing so will severely dull the cutting links and shorten the life of the chain.

# MAINTENANCE

 **WARNING:** In order to avoid personal injury and the risk of fire and electric shock, remove the battery pack before adjusting, inspecting, or cleaning the pole saw.

 **WARNING:** Any attempt to repair or replace electrical parts on this tool may be hazardous. Servicing of the tool must be performed by a qualified technician. When servicing, use only identical WEN replacement parts. Use of other parts may be hazardous or induce product failure.

 **WARNING:** Fully charge your battery every 3 months to preserve your battery's life. Do not let your battery get below 20% charge; this will cause your battery to prematurely fail. See Tables A and B below to understand what the LED lights on your charger and battery indicate.

## CLEANING & STORAGE

1. Brush or blow dust and debris out of the air vents using compressed air or a vacuum. Keep the air vents free of obstructions, sawdust, and wood chips. Do not spray, wash, or immerse the air vents in water.
2. Wipe off the housing and the plastic components using a moist, soft cloth. Do not use strong solvents or detergents on the plastic housing or plastic components. Certain household cleaners may cause damage, and may cause a shock hazard.
3. Routinely clean out the dust and debris that gathers under the tension housing, the oil outlet, and around the bar and the chain sprocket. Otherwise it can jam up the sprocket, the chain, and the lubrication system.
4. If the pole saw is not used for an extended period of time, remove the chain oil from the tank. Briefly place the chain and the guide bar in an oil bath and then wrap in oil paper to dry.

## CHECKING THE AUTOMATIC CHAIN LUBRICATION

Regularly check the functionality of the automatic chain lubrication in order to prevent overheating and the subsequent damage to the guide bar and saw chain associated with it. For this purpose, align the guide bar tip against a smooth surface (board, cut-in of a tree) and allow the pole saw to run. If an increasing amount of oil appears, the automatic chain lubrication functions properly.

## STORING THE BATTERY AND CHARGER

See charging instructions on page 14.

- Make sure the battery is fully charged before storage in order to maximize the life of the battery.
- Do not store the battery pack on the tool. Remove the battery from the tool before storage.
- After charging, the battery pack may be stored in the charger, as long as the charger is not plugged in.
- Store the charger at normal room temperature. Do not store it in excessive heat. Do not use the charger in direct sunlight or in damp conditions. Do not charge outside. Recharge at room temperature.
- Keep the charger clean and clear of debris. Do not allow foreign material to get into the recessed cavity or onto the contacts. Wipe the charger clean with a dry cloth. Do not use solvents or water, and do not place the charger in wet conditions.
- Always unplug the charger when charging is complete. Never leave your charger plugged in if it is not charging a battery.

## STORAGE

Examine the pole saw thoroughly for worn, loose or damaged parts. If you need assistance, **contact WEN customer service at 1-800-232-1195.**

Remove the battery from the tool before storing and unplug the charger before storing.

Store your pole saw, battery pack and charger in a cool, dry place – do not store the battery pack or charger where temperatures may exceed 104°F, such as in direct sunlight or inside a vehicle or metal building during the summer. Always store battery and charger indoors.

# CAUTION !

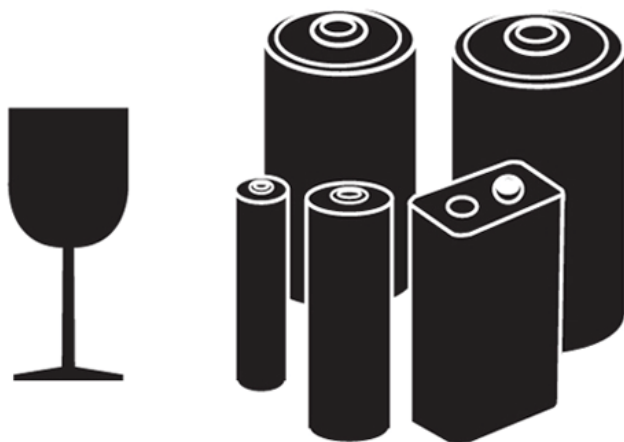

IF DAMAGED

Lithium ion battery  
**DO NOT LOAD OR TRANSPORT  
PACKAGE IF DAMAGED**

For more information call 1-800-232-1195

### **THIS SHIPMENT CONTAINS LITHIUM ION BATTERIES:**

Please handle with care. Fragile contents. Keep dry.

A flammable hazard exists if this package becomes damaged.

Special procedures must be followed in the event this package becomes damaged. Call the number below for a Safety Data Sheet.

For more information call 800-232-1195.

# EXPLODED VIEW & PARTS LIST

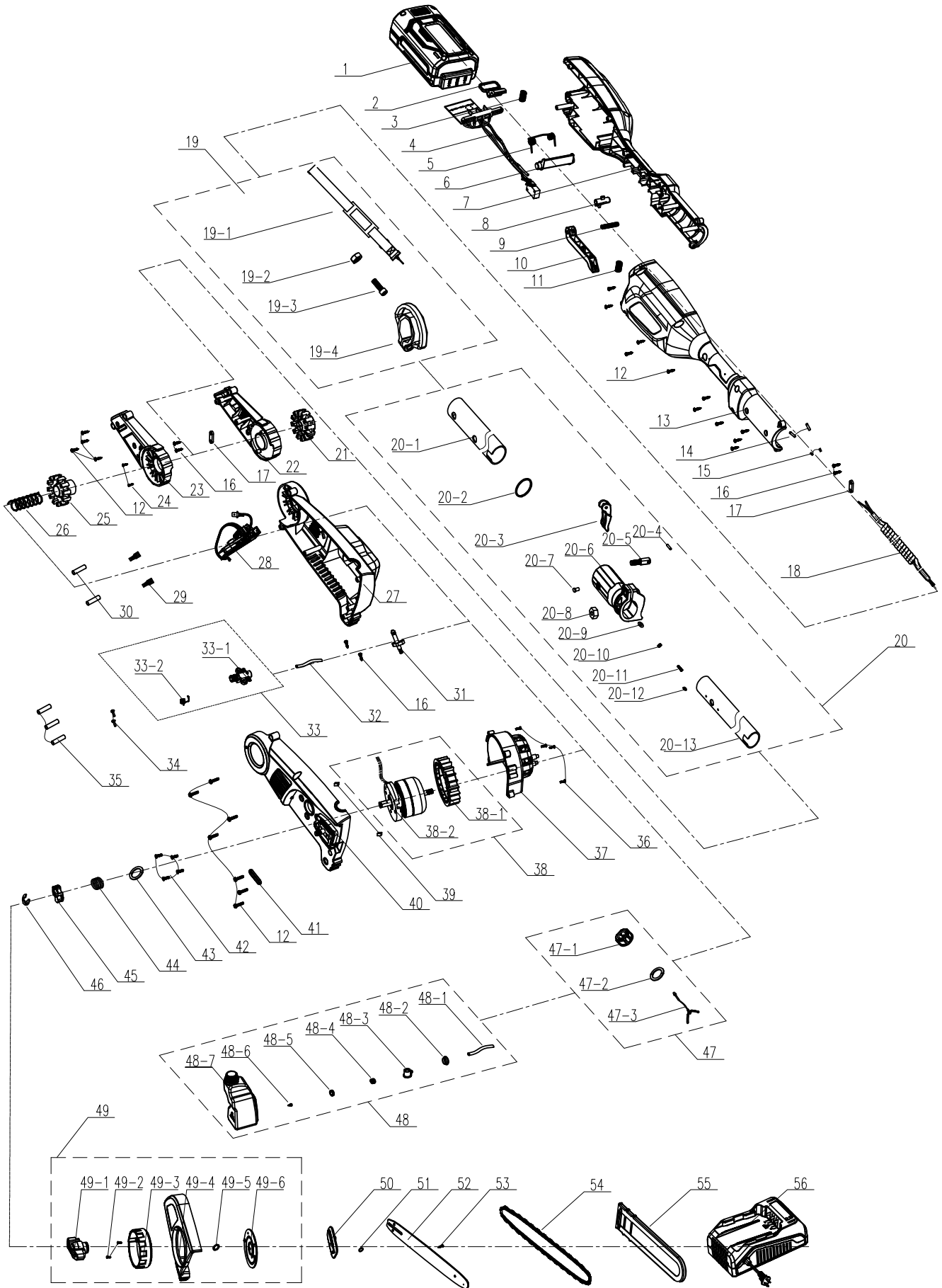

## EXPLODED VIEW & PARTS LIST

No.	Part No.	Description	Qty.
1	40401	Battery (2Ah)	1
2	40417-020	Battery Latch	1
3	40410-013	Button Spring	1
4	40421-004	Electronic Components	1
5	40439-086	Double Torsion Spring	1
6	40417-025	Shaft	1
7	40421-007	Left Handle	1
8	40413-014	Safety	1
9	40410-015	Spring	1
10	40421-010	Trigger	1
11	40421-011	Trigger Spring	1
12	40415-019	Self Tapping Screw	22
13	40421-013	Right handle	1
14	4021-023	Heat Shrinkable Tube	1
15	4017-020	Copper Strip	16
16	40421-016	Self Tapping Screw	6
17	4021-004	Cable Clamp	2
18	40421-018	Spring Connecting Line	1
19	4021-025	Telescoping Clamp	1
19-1	4021-026	Brace	1
19-2	4021-027	Hexagon Nut	1
19-3	40441-097	Pan Head Screws	1
19-4	4021-029	Brace Ring	1
20	40421-024	Tube Assembly	1
20-1	40421-033	Bassoon	1
20-2	4021-042	Large Ring	1
20-3	4021-037	Telescoping Clamp	1
20-4	4021-036	Cylindrical Pin	1
20-5	4021-038	Quick Clamping Adjusting Bolt	1
20-6	40421-029	Connecting Bracket	1
20-7	40421-030	Fixed Pin	2

No.	Part No.	Description	Qty.
20-8	4021-039	Locking Nut	1
20-9	40421-034	Flat Gasket	1
20-10	40421-035	Locking Nut	1
20-11	40421-032	Countersunk Head Screws	1
20-12	40421-036	Washer	1
20-13	40421-037	In Pipe	1
21	40421-038	Button	1
22	40421-039	Connecting Handle Of Left Casing	1
23	40421-040	Connecting Handle Of Right Casing	1
24	40421-041	Self Tapping Screw	2
25	40421-042	Driven Button	1
26	40421-043	Steering Button Spring	1
27	40421-044	Left Housing	1
28	40421-045	Electronic Components	1
29	40421-046	Female Terminal	2
30	4021-022	Heat Shrinkable Tube (Female)	1
31	40421-048	Nozzle Assembly	1
32	40421-049	Transparent Oil Tube	1
33	40421-050	Oil Pump Assembly	1
33-1	40421-051	Oil Pump Assembly	1
33-2	40421-052	Oil Pump Tension Spring	1
34	40421-053	Flange Tapping Screw	2
35	40410-026	Heat Shrinkable Tube	1
36	40439-021	Self Tapping Screw	4
37	40421-056	Motor Cover	1
38	40421-057	Motor Assembly	1
38-1	40421-058	Fan Blade	1
38-2	40421-059	Brushless Motor	1
39	40421-060	Closing Plug	2

## EXPLODED VIEW & PARTS LIST

No.	Part No.	Description	Qty.
40	40421-061	Right Housing	1
41	40417-005	Oil Feed Seal	1
42	40421-063	Countersunk Head Screws	4
43	40421-064	Felted Wool	1
44	4017-082	Tensioning Spring	1
45	4017-083	Sprocket	1
46	4017-085	Split Washer	1
47	40421-068	Oil Box Cap Assembly	1
48	40421-069	Oil Box Assembly	1
48-1	40421-070	Transparent Oil Tube	1
48-2	4017-013	Oil Tank Joint Rubber Sleeve	1
48-3	4017-012	Oil Tank Delivery Con- nection	1
48-4	4017-011	Sponge	1
48-5	4017-010	Oil Box Joint Core Plug	1
48-6	4017-008	Valve	1
48-7	40421-076	Oil Tank	1
49	40421-077	End Cap Assembly	1
49-1	40421-078	Knob	1
49-2	40421-079	Machine Screw	2
49-3	40421-080	Adjusting Knob	1
49-4	40421-081	End Cover	1
49-5	4021-086	Axis With Circlips	1
49-6	40421-083	Circle Wheel	1
50	40421-084	Push Pedal	1
51	4021-103	Seal Ring	1
52	40421-086	Guide Bar	1
53	40421-087	Pan Head Screws	1
54	40421-088	Chain Saw	1
55	40421-089	Guide Bar Sleeve	1
56	40400C	Charger	1

**NOTE:** Model 40421BT does not include battery or charger.

# WARRANTY STATEMENT

WEN Products is committed to building tools that are dependable for years. Our warranties are consistent with this commitment and our dedication to quality.

## LIMITED WARRANTY OF WEN PRODUCTS FOR HOME USE

GREAT LAKES TECHNOLOGIES, LLC (“Seller”) warrants to the original purchaser only, that all WEN consumer power tools will be free from defects in material or workmanship during personal use for a period of two (2) years from date of purchase or 500 hours of use; whichever comes first. Ninety days for all WEN products if the tool is used for professional or commercial use. Purchaser has 30 days from the date of purchase to report missing or damaged parts.

SELLER’S SOLE OBLIGATION AND YOUR EXCLUSIVE REMEDY under this Limited Warranty and, to the extent permitted by law, any warranty or condition implied by law, shall be the replacement of parts, without charge, which are defective in material or workmanship and which have not been subjected to misuse, alteration, careless handling, misrepair, abuse, neglect, normal wear and tear, improper maintenance, or other conditions adversely affecting the Product or the component of the Product, whether by accident or intentionally, by persons other than Seller. To make a claim under this Limited Warranty, you must make sure to keep a copy of your proof of purchase that clearly defines the Date of Purchase (month and year) and the Place of Purchase. Place of Purchase must be a direct vendor of Great Lakes Technologies, LLC. Purchasing through third party vendors, including but not limited to garage sales, pawn shops, resale shops, or any other secondhand merchant, voids the warranty included with this product. Contact [techsupport@wenproducts.com](mailto:techsupport@wenproducts.com) or 1-800-232-1195 with the following information to make arrangements: your shipping address, phone number, serial number, required part numbers, and proof of purchase. Damaged or defective parts and products may need to be sent to WEN before the replacements can be shipped out.

Upon the confirmation of a WEN representative, your product may qualify for repairs and service work. When returning a product for warranty service, the shipping charges must be prepaid by the purchaser. The product must be shipped in its original container (or an equivalent), properly packed to withstand the hazards of shipment. The product must be fully insured with a copy of the proof of purchase enclosed. There must also be a description of the problem in order to help our repairs department diagnose and fix the issue. Repairs will be made and the product will be returned and shipped back to the purchaser at no charge for addresses within the contiguous United States.

THIS LIMITED WARRANTY DOES NOT APPLY TO ITEMS THAT WEAR OUT FROM REGULAR USAGE OVER TIME, INCLUDING BELTS, BRUSHES, BLADES, BATTERIES, ETC. ANY IMPLIED WARRANTIES SHALL BE LIMITED IN DURATION TO TWO (2) YEARS FROM DATE OF PURCHASE. SOME STATES IN THE U.S. AND SOME CANADIAN PROVINCES DO NOT ALLOW LIMITATIONS ON HOW LONG AN IMPLIED WARRANTY LASTS, SO THE ABOVE LIMITATION MAY NOT APPLY TO YOU.

IN NO EVENT SHALL SELLER BE LIABLE FOR ANY INCIDENTAL OR CONSEQUENTIAL DAMAGES (INCLUDING BUT NOT LIMITED TO LIABILITY FOR LOSS OF PROFITS) ARISING FROM THE SALE OR USE OF THIS PRODUCT. SOME STATES IN THE U.S. AND SOME CANADIAN PROVINCES DO NOT ALLOW THE EXCLUSION OR LIMITATION OF INCIDENTAL OR CONSEQUENTIAL DAMAGES, SO THE ABOVE LIMITATION OR EXCLUSION MAY NOT APPLY TO YOU.

THIS LIMITED WARRANTY GIVES YOU SPECIFIC LEGAL RIGHTS, AND YOU MAY ALSO HAVE OTHER RIGHTS WHICH VARY FROM STATE TO STATE IN THE U.S., PROVINCE TO PROVINCE IN CANADA AND FROM COUNTRY TO COUNTRY.

THIS LIMITED WARRANTY APPLIES ONLY TO ITEMS SOLD WITHIN THE UNITED STATES OF AMERICA, CANADA AND THE COMMONWEALTH OF PUERTO RICO. FOR WARRANTY COVERAGE WITHIN OTHER COUNTRIES, CONTACT THE WEN CUSTOMER SUPPORT LINE. FOR WARRANTY PARTS OR PRODUCTS REPAIRED UNDER WARRANTY SHIPPING TO ADDRESSES OUTSIDE OF THE CONTIGUOUS UNITED STATES, ADDITIONAL SHIPPING CHARGES MAY APPLY.