

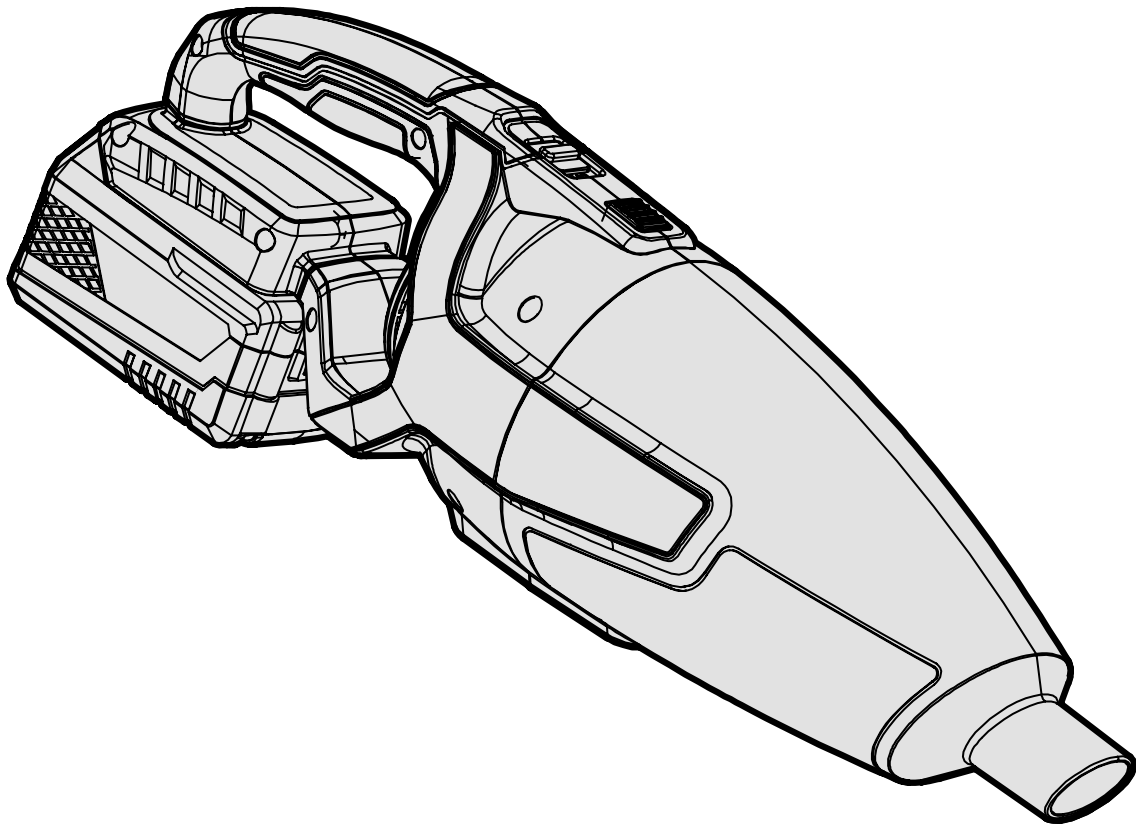

MODEL 20861, 20861BT

20V CORDLESS VACUUM

Instruction Manual



NEED HELP? CONTACT US!

Have product questions? Need technical support? Please feel free to contact us:



1-847-429-9263 (M-F 8AM-5PM CST)



TECHSUPPORT@WENPRODUCTS.COM

IMPORTANT: Your new tool has been engineered and manufactured to WEN's highest standards for dependability, ease of operation, and operator safety. When properly cared for, this product will supply you years of rugged, trouble-free performance. Pay close attention to the rules for safe operation, warnings, and cautions. If you use your tool properly and for its intended purpose, you will enjoy years of safe, reliable service.

For replacement parts and the most up-to-date instruction manuals, visit ***WENPRODUCTS.COM***

CONTENTS

WELCOME	3
Introduction	3
Specifications.....	3
SAFETY	4
General Safety Rules	4
Electrical Information.....	6
Battery & Charger Safety Warnings	7
BEFORE OPERATING	9
Unpacking & Packing List	9
Know Your Vacuum Cleaner.....	10
OPERATION & MAINTENANCE	11
Operation	11
Maintenance.....	14
Exploded View & Parts List.....	15
Warranty Statement	17

To purchase accessories and replacement parts for your tool, visit **WENPRODUCTS.COM**

20V 2.0Ah Max Battery (Model 20202)
20V 4.0Ah Max Battery (Model 20204)
20V 5.0Ah Max Battery (Model 20205)
20V 2A Charger (Model 20200C)
20V 5A Quick Charger (Model 20201Q)
Replacement HEPA Filter, 3-Pack (Model 20861AF-3)

WEN plans to continue to add more items to our 20V line. For an up-to-date list of the 20V cordless tools compatible with the included battery and charger, visit **wenproducts.com** and search model number 20202 (2Ah), 20204 (4Ah), or 20205 (5Ah). In the battery's description, there will be a list of current products that this battery can be used with.

INTRODUCTION

Thanks for purchasing the WEN 20V Vacuum. We know you are excited to put your tool to work, but first, please take a moment to read through the manual. Safe operation of this tool requires that you read and understand this operator's manual and all the labels affixed to the tool. This manual provides information regarding potential safety concerns, as well as helpful assembly and operating instructions for your tool.

 Indicates danger, warning, or caution. The safety symbols and the explanations with them deserve your careful attention and understanding. Always follow the safety precautions to reduce the risk of fire, electric shock or personal injury. However, please note that these instructions and warnings are not substitutes for proper accident prevention measures.

NOTE: The following safety information is not meant to cover all possible conditions and situations that may occur. WEN reserves the right to change this product and specifications at any time without prior notice.

At WEN, we are continuously improving our products. If you find that your tool does not exactly match this manual, please visit wenproducts.com for the most up-to-date manual or contact our customer service at **1-847-429-9263**.

Keep this manual available to all users during the entire life of the tool and review it frequently to maximize safety for both yourself and others.

SPECIFICATIONS

Model Number	20861, 20861BT
Included Battery	2.0Ah Battery (Model 20202)*
Included Charger	20V, 2A DC (Model 20200C)*
Maximum Power	94 Airwatts
Maximum Airflow	25 CFM (708 L/min)
Dust Cup Capacity	20.3 fl. oz. (600 mL)
Nozzle Diameter	1.23" (31.2mm) Outer Diameter; Compatible with 1.25" Accessories
Product Weight	1.5 Pounds
Product Dimensions	18.9 in. x 5.1 in. x 5.1 in.

Battery Models	All WEN 20V MAX Batteries**
Charger Models	All WEN 20V MAX Chargers

***NOTE:** Battery and charger only included with model 20861. Model 20861BT does not include a battery or charger.

****NOTE:** Some tools may not be compatible with WEN 20V MAX 1.5Ah Batteries, model 49120B. Contact WEN customer service at **1-847-429-9263**, M-F with questions.

WEN plans to continue to add more items to our 20V line. For an up-to-date list of the 20V cordless tools compatible with the included battery and charger, visit wenproducts.com and search model number 20202 (2Ah), 20204 (4Ah), or 20205 (5Ah). In the battery's description, there will be a list of current products that this battery can be used with.

GENERAL SAFETY RULES

 **WARNING!** Read all safety warnings and all instructions. Failure to follow the warnings and instructions may result in electric shock, fire and/or serious injury.

Safety is a combination of common sense, staying alert and knowing how your item works. The term “power tool” in the warnings refers to your mains-operated (corded) power tool or battery-operated (cordless) power tool.

SAVE THESE SAFETY INSTRUCTIONS.

WORK AREA SAFETY

- 1. Keep work area clean and well lit.** Cluttered or dark areas invite accidents.
- 2. Do not operate power tools in explosive atmospheres, such as in the presence of flammable liquids, gases or dust.** Power tools create sparks which may ignite the dust or fumes.
- 3. Keep children and bystanders away while operating a power tool.** Distractions can cause you to lose control.

ELECTRICAL SAFETY

- 1. Power tool plugs must match the outlet. Never modify the plug in any way. Do not use any adapter plugs with earthed (grounded) power tools.** Unmodified plugs and matching outlets will reduce risk of electric shock.
- 2. Avoid body contact with earthed or grounded surfaces such as pipes, radiators, ranges and refrigerators.** There is an increased risk of electric shock if your body is earthed or grounded.
- 3. Do not expose power tools to rain or wet conditions.** Water entering a power tool will increase the risk of electric shock.
- 4. Do not abuse the cord. Never use the cord for carrying, pulling or unplugging the power tool. Keep cord away from heat, oil, sharp edges or moving parts.** Damaged or entangled cords increase the risk of electric shock.
- 5. When operating a power tool outdoors, use an extension cord suitable for outdoor use.** Use of a cord suitable for outdoor use reduces the risk of electric shock.

- 6. If operating a power tool in a damp location is unavoidable, use a ground fault circuit interrupter (GFCI) protected supply.** Use of a GFCI reduces the risk of electric shock.

PERSONAL SAFETY

- 1. Stay alert, watch what you are doing and use common sense when operating a power tool. Do not use a power tool while you are tired or under the influence of drugs, alcohol or medication.** A moment of inattention while operating power tools may result in serious personal injury.
- 2. Use personal protective equipment. Always wear eye protection.** Protective equipment such as a respiratory mask, non-skid safety shoes and hearing protection used for appropriate conditions will reduce the risk of personal injury.
- 3. Prevent unintentional starting. Ensure the switch is in the off-position before connecting to power source and/or battery pack, picking up or carrying the tool.** Carrying power tools with your finger on the switch or energizing power tools that have the switch on invites accidents.
- 4. Remove any adjusting key or wrench before turning the power tool on.** A wrench or a key left attached to a rotating part of the power tool may result in personal injury.
- 5. Do not overreach. Keep proper footing and balance at all times.** This enables better control of the power tool in unexpected situations.
- 6. Dress properly. Do not wear loose clothing or jewelry. Keep your hair and clothing away from moving parts.** Loose clothes, jewelry or long hair can be caught in moving parts.

GENERAL SAFETY RULES

 **WARNING!** Read all safety warnings and all instructions. Failure to follow the warnings and instructions may result in electric shock, fire and/or serious injury.

Safety is a combination of common sense, staying alert and knowing how your item works. The term “power tool” in the warnings refers to your mains-operated (corded) power tool or battery-operated (cordless) power tool.

SAVE THESE SAFETY INSTRUCTIONS.

7. If devices are provided for the connection of dust extraction and collection facilities, ensure these are connected and properly used. Use of dust collection can reduce dust-related hazards.

POWER TOOL USE AND CARE

1. Do not force the power tool. Use the correct power tool for your application. The correct power tool will do the job better and safer at the rate for which it was designed.

2. Do not use the power tool if the switch does not turn it on and off. Any power tool that cannot be controlled with the switch is dangerous and must be repaired.

3. Disconnect the plug from the power source and/or the battery pack from the power tool before making any adjustments, changing accessories, or storing power tools. Such preventive safety measures reduce the risk of starting the power tool accidentally.

4. Store idle power tools out of the reach of children and do not allow persons unfamiliar with the power tool or these instructions to operate the power tool. Power tools are dangerous in the hands of untrained users.

5. Maintain power tools. Check for misalignment or binding of moving parts, breakage of parts and any other condition that may affect the power tool's operation. If damaged, have the power tool repaired before use. Many accidents are caused by poorly maintained power tools.

6. Keep cutting tools sharp and clean. Properly maintained cutting tools with sharp cutting edges are less likely to bind and are easier to control.

7. Use the power tool, accessories and tool bits, etc. in accordance with these instructions, taking into account the working conditions and the work to be performed. Use of the power tool for operations different from those intended could result in a hazardous situation.

8. Use clamps to secure your workpiece to a stable surface. Holding a workpiece by hand or using your body to support it may lead to loss of control.

9. KEEP GUARDS IN PLACE and in working order.

SERVICE

1. Have your power tool serviced by a qualified repair person using only identical replacement parts. This will ensure that the safety of the power tool is maintained.

CALIFORNIA PROPOSITION 65 WARNING

Some dust created by power sanding, sawing, grinding, drilling, and other construction activities may contain chemicals, including lead, known to the State of California to cause cancer, birth defects, or other reproductive harm. Wash hands after handling. Some examples of these chemicals are:

- Lead from lead-based paints.
- Crystalline silica from bricks, cement, and other masonry products.
- Arsenic and chromium from chemically treated lumber.

Your risk from these exposures varies depending on how often you do this type of work. To reduce your exposure to these chemicals, work in a well-ventilated area with approved safety equipment such as dust masks specially designed to filter out microscopic particles.

ELECTRICAL INFORMATION (CHARGER)

DOUBLE-INSULATED CHARGER

The charger's electrical system is double-insulated where two systems of insulation are provided. This eliminates the need for the usual three-wire grounded power cord. Double-insulated tools do not need to be grounded, nor should a means for grounding be added to the product. All exposed metal parts are isolated from the internal metal components with protecting insulation.

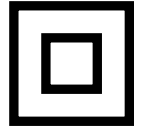

IMPORTANT: Servicing a double-insulated product requires extreme care and knowledge of the system, and should be done only by qualified service personnel using identical replacement parts. Always use original factory replacement parts when servicing.

1. Polarized Plugs. To reduce the risk of electric shock, this equipment has a polarized plug (one blade is wider than the other). This plug will fit in a polarized outlet only one way. If the plug does not fit fully in the outlet, reverse the plug. If it still does not fit, contact a qualified electrician to install a proper outlet. Do not modify the machine plug or the extension cord in any way.

2. Ground fault circuit interrupter protection (GFCI) should be provided on the circuit or outlet used for this power tool to reduce the risk of electric shock.

3. Service and repair. To avoid danger, electrical appliances must only be repaired by a qualified service technician using original replacement parts.

GUIDELINES AND RECOMMENDATIONS FOR EXTENSION CORDS

When using an extension cord, be sure to use one heavy enough to carry the current your product will draw. An undersized cord will cause a drop in line voltage, resulting in loss of power and overheating. The table below shows the correct size to be used according to cord length and ampere rating. When in doubt, use a heavier cord. The smaller the gauge number, the heavier the cord.

AMPERAGE	REQUIRED GAUGE FOR EXTENSION CORDS			
	25 ft.	50 ft.	100 ft.	150 ft.
2A	18 gauge	16 gauge	16 gauge	14 gauge

1. Examine extension cord before use. Make sure your extension cord is properly wired and in good condition. Always replace a damaged extension cord or have it repaired by a qualified person before using it.

2. Do not abuse extension cord. Do not pull on cord to disconnect from receptacle; always disconnect by pulling on plug. Disconnect the extension cord from the receptacle before disconnecting the product from the extension cord. Protect your extension cords from sharp objects, excessive heat and damp/wet areas.

3. Use a separate electrical circuit for your tool. This circuit must not be less than a 12-gauge wire and should be protected with a 15A time-delayed fuse. Before connecting the motor to the power line, make sure the switch is in the OFF position and the electric current is rated the same as the current stamped on the motor nameplate. Running at a lower voltage will damage the motor.

BATTERY & CHARGER SAFETY WARNINGS

Despite all of the safety precautions, caution must always be taken when handling batteries. The following points must be obeyed at all times to ensure safe use. Safe use can only be guaranteed if undamaged cells are used. Incorrect handling of the battery pack can cause cell damage.

- **Avoid dangerous environments** – Do not charge the battery pack in rain, snow or in damp or wet locations. Do not use the battery pack or charger in the presence of explosive atmospheres (gaseous fumes, dust or flammable materials) because sparks may be generated when inserting or removing the battery pack, which could lead to a fire.

- **Charge in a well-ventilated area** – Do not block the charger vents. Keep them clear to allow for proper ventilation. Do not allow smoking or open flames near a charging battery pack. Vented gases may explode.

NOTE: The safe temperature range for the battery charging is -4°F to 113°F. Do not charge the battery outside in freezing weather; charge it at room temperature.

- **Maintain charger cord** – When unplugging the charger, pull the plug, not the cord, from the receptacle to reduce the risk of damage to the electrical plug and cord. Never carry the charger by its cord or yank it by the cord to disconnect it from the receptacle. Keep the cord away from heat, oil and sharp edges. Make sure the cord will not be stepped on, tripped over or subjected to damage or stress when the charger is in use. Do not use the charger with a damaged cord or plug. Replace a damaged charger immediately.

- **Do not use an extension cord unless it is absolutely necessary** – Using the wrong, damaged or improperly wired extension cord poses a risk of fire and electric shock. If an extension cord must be used, plug the charger into a properly wired 16 gauge or larger extension cord with the female plug matching the male plug on the charger. Make sure that the extension cord is in good electrical condition.

- **Charger is rated for 120 volt AC only** – The charger must be plugged into an appropriate receptacle.

- **Use only recommended attachments** – Use of an attachment not recommended or sold by WEN Products may result in risk of fire, electric shock or personal injury.

- **Unplug charger when not in use** – Make sure to remove battery packs from unplugged chargers.

 **WARNING!** To reduce the risk of electric shock, always unplug the charger before performing any cleaning or maintenance. Do not allow water to flow into the charger. Use a Ground Fault Circuit Interrupter (GFCI) to reduce shock hazards.

- **Do not burn or incinerate battery packs** – Battery packs may explode, causing personal injury or damage. Toxic fumes and materials are created when battery packs are burned.

- **Do not crush, drop or damage battery packs** – Do not use the battery pack or charger if they have sustained a sharp blow, been dropped, run over or have been damaged in any way (i.e. pierced with a nail, hit with a hammer, stepped on, etc.).

- **Do not disassemble** – Incorrect reassembly may pose a serious risk of electric shock, fire or exposure to toxic battery chemicals. If the battery or charger are damaged, call WEN customer service at **1-847-429-9263** for assistance.

- **Battery chemicals cause serious burns** – Never let a damaged battery pack contact the skin, eyes or mouth. If a damaged battery pack leaks battery chemicals, use rubber or neoprene gloves to safely dispose of it. If skin is exposed to battery fluids, wash the affected area with soap and water and rinse with vinegar. If eyes are exposed to battery chemicals, immediately flush with water for 20 minutes and seek medical attention. Remove and dispose of contaminated clothing.

- **Store your battery pack and charger in a cool, dry place** – Do not store the battery pack or charger where temperatures may exceed 104 °F, such as in direct sunlight or inside a vehicle or metal building during the summer.

- **Do not short circuit** – A battery pack will short circuit if a metal object makes a connection between the positive and negative contacts on the battery pack. Do not place a battery pack near anything that may cause a short circuit, such as paper clips, coins, keys, screws, nails and other metallic objects. A short-circuited battery pack poses a risk of fire and severe personal injury.

BATTERY & CHARGER SAFETY WARNINGS

ABOUT THE BATTERY

1. The battery pack has to be charged completely before you use the tool for the first time.
2. For optimum battery performance, avoid low discharge cycles by charging the battery pack frequently.
3. Lithium-ion batteries are subject to a natural aging process. The battery pack must be replaced at the latest when its capacity falls to just 80% of its capacity when new. Weakened cells in an aged battery pack are no longer capable of meeting the high power requirements needed for the proper operation of your tool, and therefore pose a safety risk.
4. Do not throw battery packs into an open fire as this poses a risk of explosion. Do not ignite the battery pack or expose it to fire.
5. Do not exhaustively discharge batteries. Exhaustive discharge will damage the battery cells. The most common cause of exhaustive discharge is lengthy storage or non-use of partially discharged batteries. Stop working as soon as the performance of the battery falls noticeably or the electronic protection system triggers. Place the battery pack in storage only after it has been fully charged.
6. Protect batteries and the tool from overloads. Overloads will quickly result in overheating and cell damage inside the battery housing even if this overheating is not apparent externally.
7. Avoid damage and shocks. Immediately replace batteries that have been dropped from a height of more than one meter or those that have been exposed to violent shocks, even if the housing of the battery pack appears to be undamaged. The battery cells inside the battery may have suffered serious damage. In such instances, please read the waste disposal information for proper battery disposal.
8. If the battery pack suffers overloading and overheating, the integrated protective cutoff will switch off the equipment for safety reasons.
9. Use only original battery packs. The use of other batteries poses a fire risk and may result in injuries or an explosion.

ABOUT THE CHARGER

Protect battery charger and cord from damage. Keep the charger and its cord away from heat, oil and sharp edges.

Electrical plugs must match the outlet. Never modify the plug in any way. Do not use any adapter plugs with grounded appliances. Unmodified plugs and matching outlets will reduce the risk of electric shock.

Keep the battery charger, battery pack(s), and the cordless tool out of the reach of children.

Do not use the supplied battery charger to charge other cordless tools.

During periods of heavy use, the battery pack will become warm. Allow the battery pack to cool to room temperature before inserting it into the charger to recharge.

Do not overcharge batteries. Do not exceed the maximum charging times. These charging times only apply to discharged batteries. Frequent insertion of a charged or partially charged battery pack will result in overcharging and cell damage. Do not leave battery in the charger for days on end.

Never use or charge a battery if you suspect that it has been more than 12 months since last time they were charged. There is a high probability that battery pack has already suffered dangerous damage (exhaustive discharge).

Do not use battery that have been exposed to heat during the charging process, as the battery cells may have suffered dangerous damage.

Do not use battery that have suffered curvature or deformation during the charging process or those that exhibit other atypical symptoms (gassing, hissing, cracking, etc.)

UNPACKING & PACKING LIST

UNPACKING

Carefully remove the vacuum from the packaging and place it on a sturdy, flat surface. Make sure to take out all contents and accessories. Do not discard the packaging until everything is removed. Check the packing list below to make sure you have all of the parts and accessories. If any part is missing or broken, please contact customer service at **1-847-429-9263** (M-F 8-5 CST), or email techsupport@wenproducts.com.

Components

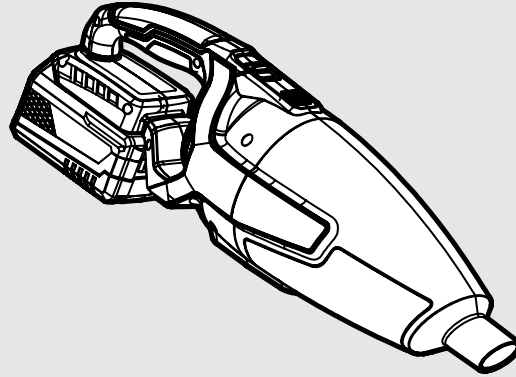

Vacuum

Accessories

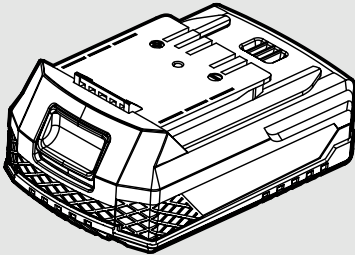

20V Battery (1)*

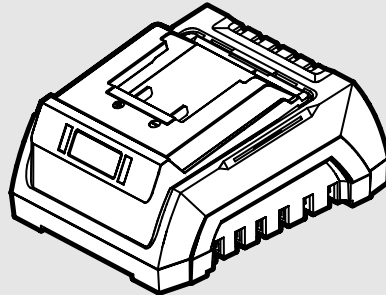

20V Charger (1)*

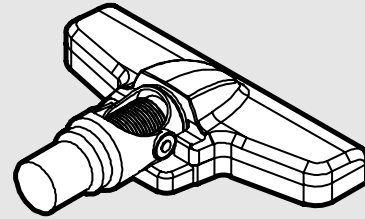

Floor Brush (1)



Extension Tube (1)

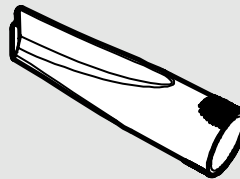

Crevice Nozzle (1)

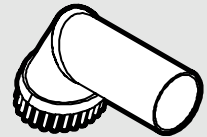

Brush Nozzle (1)

*Only included with model number 20861.

KNOW YOUR VACUUM CLEANER

TOOL PURPOSE

From your woodshop to your car, your WEN 20V Vacuum can handle all your spring cleaning. Refer to the following diagrams to become familiarized with all the parts and controls of your vacuum. The components will be referred to later in the manual for assembly and operation instructions.

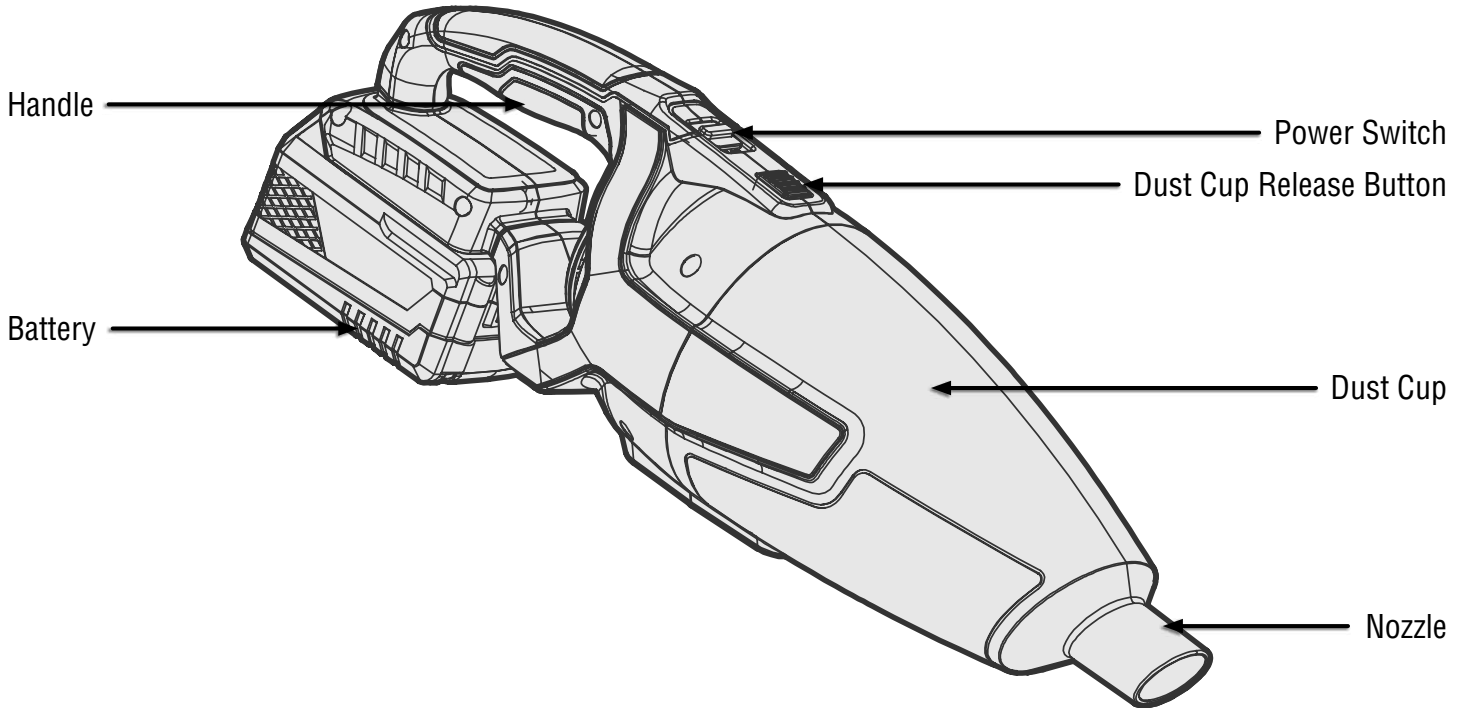

OPERATION

⚠ WARNING! To prevent serious injury, make sure all the instructions have been read and understood before operating this tool. Make sure that the tool is powered OFF and the battery is removed from the tool for all adjustments and maintenance.

MOUNTING ACCESSORIES

Turn the vacuum off when changing vacuum accessories.

The vacuum cleaner accessories can be connected directly to the nozzle port on the dust cup (Fig. 1 - 1).

There are six combination possibilities of the various vacuum cleaner accessories (Fig. 2).

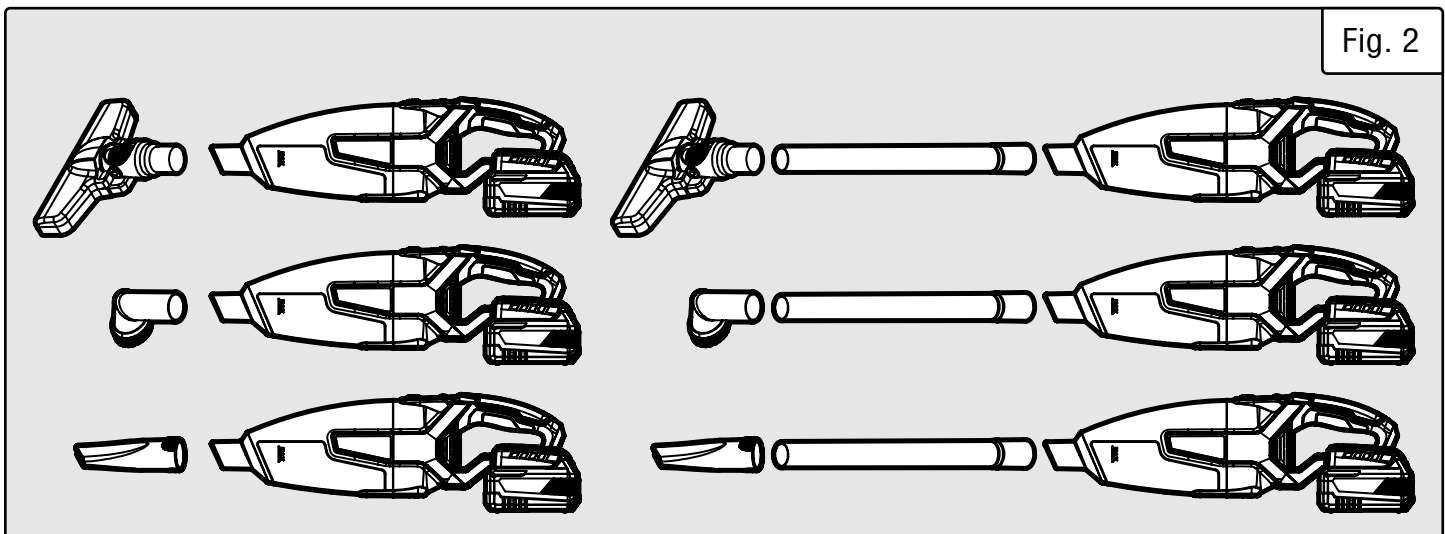
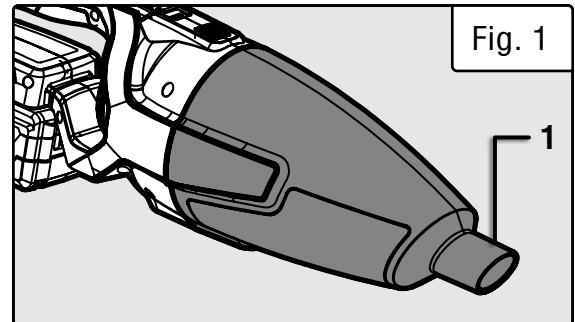

TURNING THE VACUUM ON & OFF

1. To turn the vacuum ON, push the power switch (Fig. 3 - 1) forward to the ON position.

2. To turn the vacuum OFF, pull the power switch backward to the OFF position.

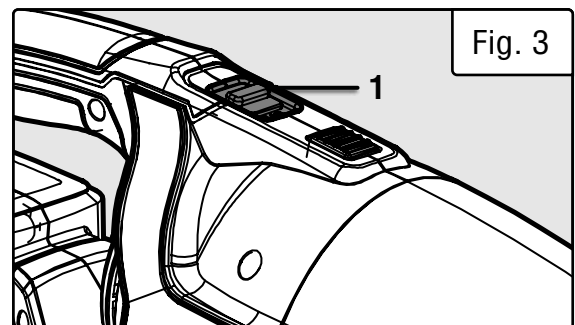

⚠ WARNING! Your vacuum is designed for dry use ONLY. DO NOT use the vacuum to pick up any liquids or other fluids. You will damage the vacuum, void your warranty, and may injure yourself or others.

OPERATION

⚠ WARNING! To prevent serious injury, make sure all the instructions have been read and understood before operating this tool. Make sure that the tool is powered OFF and the battery is removed from the tool for all adjustments and maintenance.

CLEANING THE DUST CUP & FILTER

For the best performance, the vacuum, dust cup, and filter should be cleaned after every use.

NOTE: Consider that when you clean the vacuum, you yourself become the vacuum cleaner. Do with this knowledge what you will.

1. Make sure that the vacuum is turned off and the battery is removed before cleaning any part of the vacuum.

2. Press the dust cup release button (Fig. 4 - 1) to open the dust cup.

3. Remove the filter assembly from the dust cup (Fig. 5).

4. Tap the dust cup over a trash can to empty, and wipe it with a moist, clean cloth if needed. Allow it to dry completely before reassembling the vacuum. While the cup dries, finish up that 1,000 piece puzzle you've been putting off all year.

5. Remove the filter (Fig. 5 - 1) from the filter seal (Fig. 5 - 2) by twisting them apart counterclockwise.

6. Clean the filter with a soft brush or wash it in mild soap and water. Thoroughly rinse out all soap and dust and allow the filter to dry completely before reassembling.

7. If your filter is damaged or worn, it should be replaced. Replace the filter every 6 - 12 months for optimum performance. Replacement filters can be purchased in 3-packs from wenproducts.com, model **20861AF-3**. The filter is not covered under the warranty.

8. Reattach the filter to the filter seal by twisting them together. The dust cup release button will snap into place.

9. Insert the clean filter assembly into the dust cup. Reattach the motor housing to the dust cup by pressing them together until the dust cup release button snaps into place.

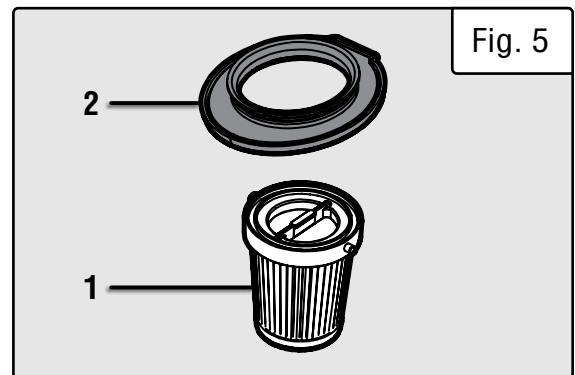
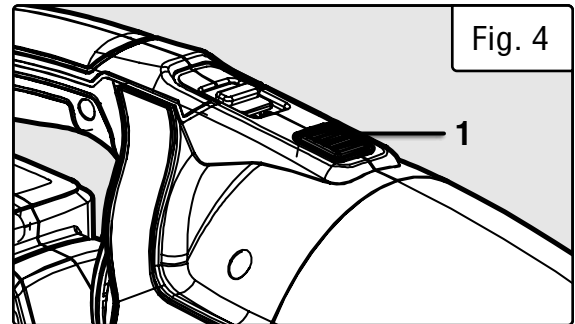

OPERATION

 **WARNING!** To prevent serious injury, make sure all the instructions have been read and understood before operating this tool. Make sure that the tool is powered OFF and the battery is removed from the tool for all adjustments and maintenance.

CHARGING THE BATTERY PACK

The 20V battery pack for this tool is supplied in a low charge condition to prevent possible problems, and must be charged completely before you use the tool for the first time.

1. Connect charger to a 120V, 60Hz AC outlet. The green light on the charger will illuminate, indicating that the charger is powered.
2. Slide the battery all the way into the charger until it clicks. The red light on the charger will illuminate, indicating that the battery is charging.

Charging Indication:

- Solid Green: Ready to Charge
- Solid Red: Charging
- Solid Green: Charged

3. When the battery is charged, the red light will turn off and the green light will turn on. Remove the battery from the charger and unplug the charger from the power supply.

NOTE: Battery will not reach full charge the first time it is charged. Allow several cycles for the battery to fully charge. The battery pack may become warm while charging; this is normal. If the battery is hot after continuous use in the tool, allow it to cool to room temperature before charging. This will prolong the life of your battery.

The battery pack is equipped with three LED battery life indication lights. Press and hold the power button on the rear of the battery to check the battery's charge status.

Battery Life Indication:

- Three Lights: The battery is fully charged.
- Two Lights: The battery is about 60% charged.
- One Light: The battery is almost out of power and needs to be charged.

INSERTING AND REMOVING THE BATTERY

1. To install the battery, slide the battery pack into the battery port at the top of the band saw. Make sure the release latch on the rear side of the battery pack snaps into place and battery is secure before beginning operation.
2. To remove the battery pack, press the battery release latch on the front of the battery and pull the battery pack out.

MAINTENANCE

 **WARNING!** To prevent serious injury, make sure all the instructions have been read and understood before operating this tool. Make sure that the tool is powered OFF and the battery is removed from the tool for all adjustments and maintenance.

ROUTINE INSPECTION

1. Before each use, inspect the general condition of the tool.

Check for:

- Loose hardware,
- Misalignment or binding of moving parts,
- Damaged cord/electrical wiring,
- Cracked or broken parts, and
- Any other condition that may affect its safe operation.

2. After every use, wipe the tool with a soft cloth. Do not let water enter the tool.

3. Keep the ventilation openings free from dust and debris to prevent the motor from overheating.

4. Most plastics are susceptible to damage from various types of commercial solvents. Do not use any solvents or cleaning products that could damage the plastic parts. Some of these include but are not limited to: gasoline, carbon tetrachloride, chlorinated cleaning solvents, ammonia and household detergents that contain ammonia.

5. Store the tool in a clean and dry place away from the reach of children.

PRODUCT DISPOSAL

Used power tools should not be disposed of together with household waste. This product contains electronic components that should be recycled. Please take this product to your local recycling facility for responsible disposal and to minimize its environmental impact.

EXPLODED VIEW & PARTS LIST

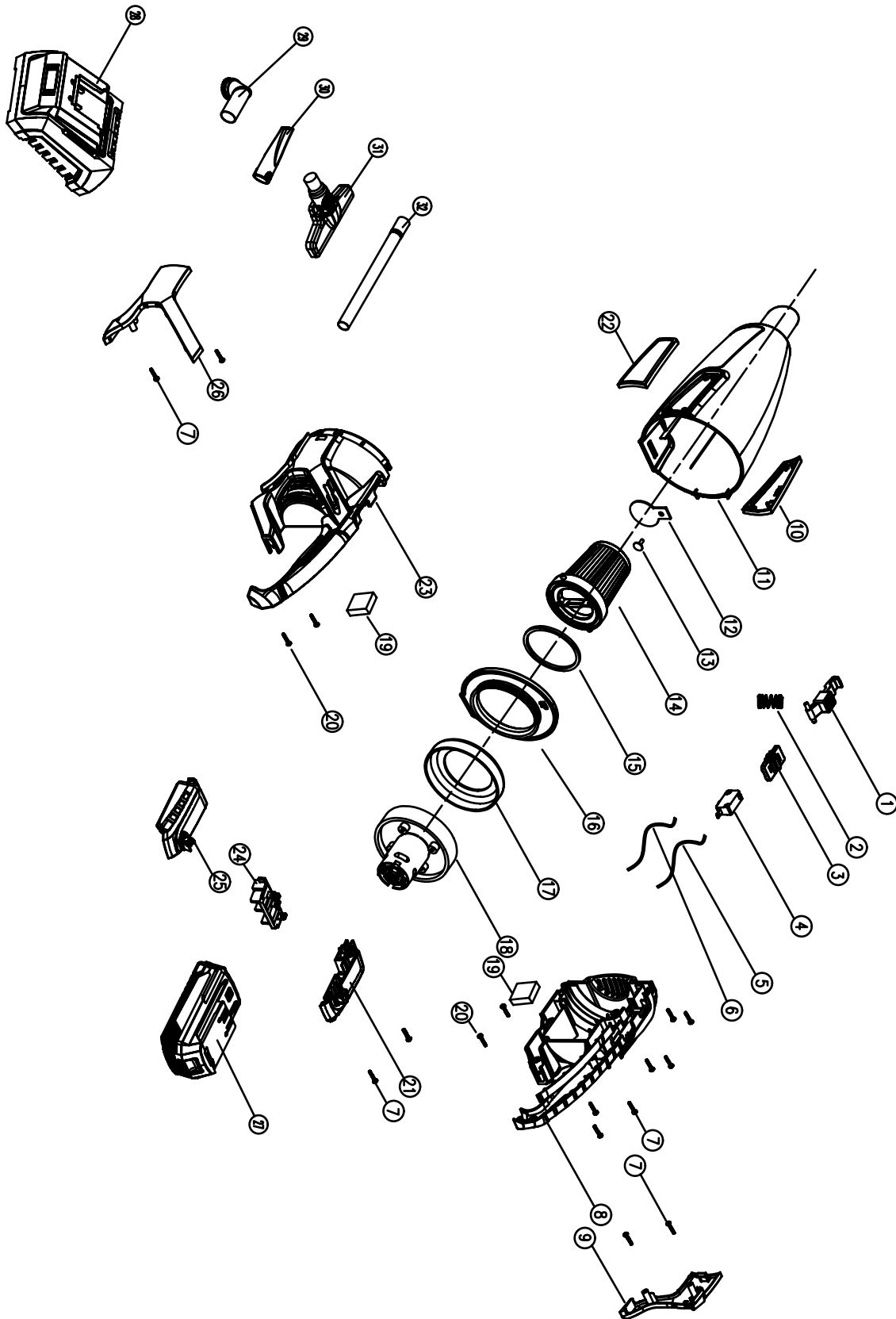

NOTE: Not all parts may be available for purchase. Parts and accessories that wear down over the course of normal use are not covered under the warranty.

EXPLODED VIEW & PARTS LIST

No.	Part No.	Description	Qty.	No.	Part No.	Description	Qty.
1	20861-001	Release Button	1	17	20861-017	Rubber Ring	1
2	20861-002	Spring	1	18	20861-018	Motor Assembly	1
3	20861-003	Switch Push Plate	1	19	20861-019	Dust-Proof Sponge	2
4	20861-004	Switch	1	20	20861-020	Screw ST3x10	4
5	20861-005	Lead Wire (Brown)	1	21	20861-021	Battery Right Connector	1
6	20861-006	Lead Wire (Black)	1	22	20861-022	Dust Cup Left Mount	1
7	20861-007	Screw ST2.9x14	13	23	20861-023	Left Enclosure	1
8	20861-008	Right Enclosure	1	24	20861-024	Battery Terminal	1
9	20861-009	Right Enclosure Mount	1	25	20861-025	Battery Left Connector	1
10	20861-010	Dust Cup Right Mount	1	26	20861-026	Left Enclosure Mount	1
11	20861-011	Dust Cup	1	27	20202	Battery	1
12	20861-012	Gasket	1	28	20200C	Charger	1
13	20861-013	Screw ST3x8	1	29	20861-029	Brush Nozzle	1
14	20861-014	HEPA Filter Assembly	1	30	20861-030	Crevice Nozzle	1
15	20861-015	Dust-Proof Ring	1	31	20861-031	Floor Brush	1
16	20861-016	Dust Cup Shift Assembly	1	32	20861-032	Extension Tube	1

NOTE: Not all parts may be available for purchase. Parts and accessories that wear down over the course of normal use are not covered under the warranty.

WARRANTY STATEMENT

WEN Products is committed to building tools that are dependable for years. Our warranties are consistent with this commitment and our dedication to quality.

LIMITED WARRANTY OF WEN PRODUCTS FOR HOME USE

GREAT LAKES TECHNOLOGIES, LLC (“Seller”) warrants to the original purchaser only, that all WEN consumer power tools will be free from defects in material or workmanship during personal use for a period of two (2) years from date of purchase or 500 hours of use; whichever comes first. Ninety days for all WEN products if the tool is used for professional or commercial use. Purchaser has 30 days from the date of purchase to report missing or damaged parts.

SELLER’S SOLE OBLIGATION AND YOUR EXCLUSIVE REMEDY under this Limited Warranty and, to the extent permitted by law, any warranty or condition implied by law, shall be the replacement of parts, without charge, which are defective in material or workmanship and which have not been subjected to misuse, alteration, careless handling, misrepair, abuse, neglect, normal wear and tear, improper maintenance, or other conditions adversely affecting the Product or the component of the Product, whether by accident or intentionally, by persons other than Seller. To make a claim under this Limited Warranty, you must make sure to keep a copy of your proof of purchase that clearly defines the Date of Purchase (month and year) and the Place of Purchase. Place of Purchase must be a direct vendor of Great Lakes Technologies, LLC. Purchasing through third party vendors, including but not limited to garage sales, pawn shops, resale shops, or any other secondhand merchant, voids the warranty included with this product. Contact techsupport@wenproducts.com or 1-847-429-9263 with the following information to make arrangements: your shipping address, phone number, serial number, required part numbers, and proof of purchase. Damaged or defective parts and products may need to be sent to WEN before the replacements can be shipped out.

Upon the confirmation of a WEN representative, your product may qualify for repairs and service work. When returning a product for warranty service, the shipping charges must be prepaid by the purchaser. The product must be shipped in its original container (or an equivalent), properly packed to withstand the hazards of shipment. The product must be fully insured with a copy of the proof of purchase enclosed. There must also be a description of the problem in order to help our repairs department diagnose and fix the issue. Repairs will be made and the product will be returned and shipped back to the purchaser at no charge for addresses within the contiguous United States.

THIS LIMITED WARRANTY DOES NOT APPLY TO ITEMS THAT WEAR OUT FROM REGULAR USAGE OVER TIME, INCLUDING BELTS, BRUSHES, BLADES, BATTERIES, ETC. ANY IMPLIED WARRANTIES SHALL BE LIMITED IN DURATION TO TWO (2) YEARS FROM DATE OF PURCHASE. SOME STATES IN THE U.S. AND SOME CANADIAN PROVINCES DO NOT ALLOW LIMITATIONS ON HOW LONG AN IMPLIED WARRANTY LASTS, SO THE ABOVE LIMITATION MAY NOT APPLY TO YOU.

IN NO EVENT SHALL SELLER BE LIABLE FOR ANY INCIDENTAL OR CONSEQUENTIAL DAMAGES (INCLUDING BUT NOT LIMITED TO LIABILITY FOR LOSS OF PROFITS) ARISING FROM THE SALE OR USE OF THIS PRODUCT. SOME STATES IN THE U.S. AND SOME CANADIAN PROVINCES DO NOT ALLOW THE EXCLUSION OR LIMITATION OF INCIDENTAL OR CONSEQUENTIAL DAMAGES, SO THE ABOVE LIMITATION OR EXCLUSION MAY NOT APPLY TO YOU.

THIS LIMITED WARRANTY GIVES YOU SPECIFIC LEGAL RIGHTS, AND YOU MAY ALSO HAVE OTHER RIGHTS WHICH VARY FROM STATE TO STATE IN THE U.S., PROVINCE TO PROVINCE IN CANADA AND FROM COUNTRY TO COUNTRY.

THIS LIMITED WARRANTY APPLIES ONLY TO ITEMS SOLD WITHIN THE UNITED STATES OF AMERICA, CANADA AND THE COMMONWEALTH OF PUERTO RICO. FOR WARRANTY COVERAGE WITHIN OTHER COUNTRIES, CONTACT THE WEN CUSTOMER SUPPORT LINE. FOR WARRANTY PARTS OR PRODUCTS REPAIRED UNDER WARRANTY SHIPPING TO ADDRESSES OUTSIDE OF THE CONTIGUOUS UNITED STATES, ADDITIONAL SHIPPING CHARGES MAY APPLY.

**THANKS FOR
REMEMBERING** **W**[®]
WEN