

2 YEARS LIMITED WARRANTY
PORTUGAL and SPAIN CUSTOMERS: 3 YEARS LIMITED WARRANTY
OR AS REQUIRED BY LOCAL LAWS

We pride ourselves on the quality of our products. For complete warranty details and a list of our Worldwide offices, please visit www.Targus.Com. Targus product warranty does not cover any device or product that is not manufactured by Targus (including, but not limited to, laptops, smartphones, devices, or any other product that may be used in connection with the Targus product). Targus is a registered trademark of Targus International LLC in the U.S. and in certain other countries. USB Type-C and USB-C are registered trademarks of USB Implementers. All logos and registered trademarks are the property of their respective owners. ©2022 Targus International LLC, 1211 North Miller St., Anaheim, CA 92806. All rights reserved.

GARANTIE LIMITÉE DE 2 ANS
CLIENTS DU PORTUGAL ET DE L'ESPAGNE : GARANTIE LIMITÉE DE 3 ANS
OU TEL QUE REQUIS PAR LES LOIS LOCALES

Nous sommes fiers de la qualité de nos produits. Pour plus de renseignements sur la garantie complète et une liste de nos bureaux à travers le monde, veuillez consulter www.targus.com. La garantie sur les produits Targus ne couvre pas les dispositifs ni les produits qui ne sont pas fabriqués par Targus (y compris, sans toutefois y être limité, les ordinateurs portables, les téléphones portables et autres dispositifs et produits qui peuvent être utilisés en conjonction avec un produit Targus). Targus est une marque déposée de Targus International LLC, aux États-Unis et dans certains autres pays. USB Type-C et USB-C sont des marques déposées de USB Implementers. Tous les logos et marques de commerce enregistrées sont la propriété exclusive de leur propriétaire. ©2022 Targus International LLC, 1211 North Miller St., Anaheim, CA 92806. Tous droits réservés.

GARANTÍA LIMITADA DE 2 AÑOS
CLIENTES PORTUGAL y ESPAÑA: GARANTÍA LIMITADA DE 3 AÑOS
O SEGÚN LO EXIJAN LAS LEYES LOCALES

Nos sentimos muy orgullosos de la calidad de nuestros productos. Para acceder a toda la información de la garantía y a una lista de nuestras oficinas en el mundo, visite www.targus.com. La garantía de producto Targus no cubre ningún dispositivo o producto que no haya sido fabricado por Targus (incluyendo sin limitación, computadoras portátiles, smartphones, dispositivos o cualquier otro producto que pudiera usarse en conexión con el producto Targus). Targus es un marca registrada de Targus International LLC en los EE. UU. y en otros países. USB Type-C y USB-C son marcas comerciales registradas de USB Implementers. Todos los logotipos y marcas comerciales registradas son propiedad de sus respectivos dueños. ©2022 Targus International LLC, 1211 North Miller St., Anaheim, CA 92806. Todos los derechos reservados.

©2022 Targus, Manufacturer: Targus International LLC 1211 North Miller Street Anaheim, CA 92806 USA
©2022 Targus, UK Importer: Targus Europe Ltd, Fourth Floor, One London Road, Staines, TW18 4EX, UK
©2022 Targus, EU Importer: Targus Europe Ltd, Targus EMEA Account Management, Van Hilstraat 19, 5145 RK Waalwijk, Netherlands

CAN ICES-3(B)/NMB-3(B)



Targus®

100W GaN AC TRAVEL ADAPTER

User Guide

Product name: GaN AC Travel Adapter
Model: APA109
SKU: APA109GL

Table of Contents

GB – English	4
DE – Deutsch	14
FR – Français	23
CZ – Čeština	32
DK – Dansk	40
FI – Suomi	48
GR – Ελληνικά Πληροφορίες	56
IT – Italiano	64
NL – Nederlands	73
NO – Norsk	82
PL – Polski	90
PT – Português	98
RU – Русский Информация	107

SE – Svenska	116
TR – Türkçe	124
ES – Español	133
AR – العربية	142
BG – Български (език)	150
HR – Hrvatski	158
HU – Magyar	166
LT – Lietuviškai	174
RO – Român	182
SK – Slovenčina	190
SL – Slovensko	198
LV – Latviešu	206
EE – Eesti	214

GB Introduction

This wall charger featuring GaN technology and interchangeable plugs for international use enables simultaneous multiple device charging of laptops, tablets, smartphones, and other USB powered devices from various brands including Apple, Dell, Google, Lenovo, Samsung, and others.

Contents

- Targus 100W GaN AC travel adapter
- US, EU, UK, AU - AC plug
- User Guide

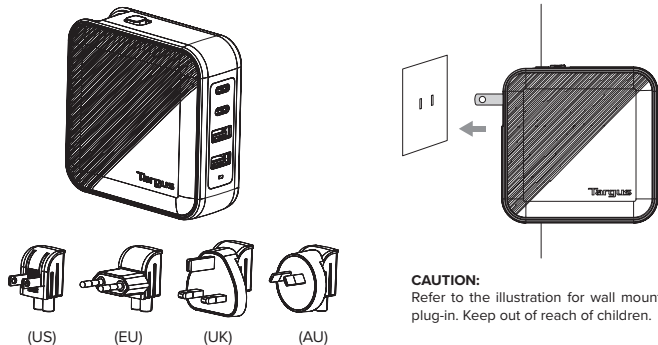

CAUTION:
Refer to the illustration for wall mount plug-in. Keep out of reach of children.

Electrical Rating

Input: 100 - 240VAC 1.8A MAX 50/60Hz

Output:

Single Port:

USB-C1/C2 PD: 5.0V/9.0V/12.0V/15.0V = 3.0A, 20.0V = 5.0A

USB-C1/C2: PPS 3.30-21.0V = 5.0A 100.0W MAX

USB-A1/A2 QC3.0: 5.0V = 3.0A, 9.0V = 2.0A, 12.0V = 1.5A, 18.0W MAX

Multi Port:

USB-C1+USB-C2: 65.0W+30.0W

USB-C1+USB-C2+USB-A1/A2: 45.0W+30.0W+18.0W (QC3.0)

USB-C1/C2+USB-A1+USB-A2: 65.0W+18.0W (NO QC3.0)

USB-C1+USB-C2+USB-A1+USB-A2: 45.0W+30.0W+18.0W (NO QC3.0)

Total: 100.0W MAX

Operation

Item	Requirements
Operating temperature	0°C to 35°C
Storage temperature	-20°C to 85°C
Relative humidity	20% to 80%, non-condensing
Storage humidity	5% to 95%, non-condensing
Long term altitude	Less than 5000m
Storage altitude	Less than 15000m

IMPORTANT INSTRUCTIONS OF CHANGING THE INTERCHANGEABLE AC PLUGS

Procedures:

1. Confirm the appropriate interchangeable AC plug before use.

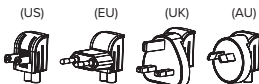

2. When changing the interchangeable AC plug (US AC plug as an example to illustrate the procedures), slide top lever forward first and remove it.

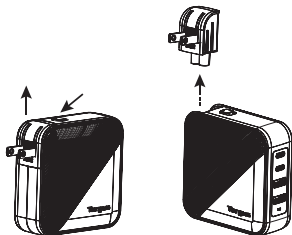

3. Slide in the appropriate interchangeable AC plug for the country you are in.

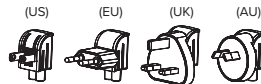

READ ALL INSTRUCTIONS BEFORE USE

IMPORTANT SAFETY INSTRUCTIONS

Safety Precautions

1. Always be sure the rated input voltage of the wall charger is compatible with the outlet you intend to use.
2. The wall charger must be fully inserted into the outlet. Never use the wall charger if the pin or blade is exposed.
3. Confirm the interchangeable AC plug is appropriate for the country you are in, before plugging into the outlet.
4. Never touch any metal part of the wall charger when in use.
5. The product is designed for indoor use only.
6. If the metal pin of the AC plugs becomes deformed or is loose, discontinue use.

If both USB-A ports are connected, QC3.0 feature will be disabled

Output Single Port:

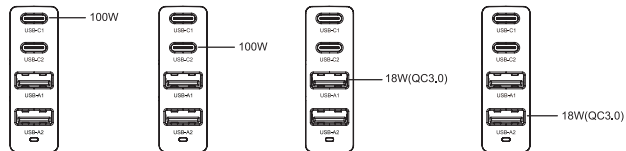

Output Dual Ports:

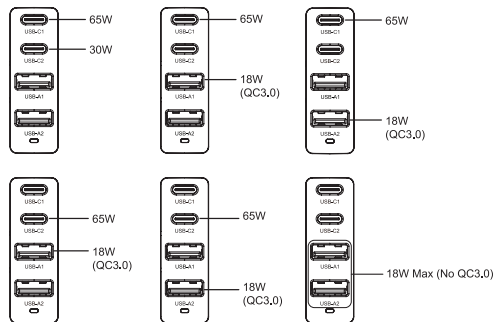

Output Three Ports:

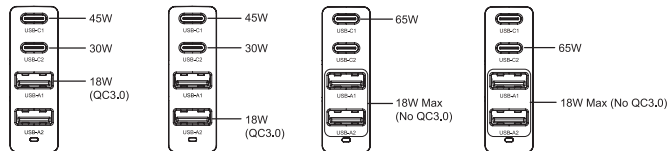

Output All Ports:

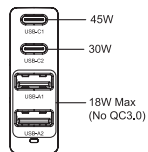

External Power Supply Information

Manufacturer	Targus International LLC
Address	1211 North Miller Street, Anaheim, CA 92806 USA
Commercial Registration Number	5892659
Model/Reg	APA109
Input voltage	100-240V~
Input AC frequency	50/60Hz
Output voltage	Single Port: USB-C1/C2 PD: 5.0V/9.0V/12.0V/15.0V = 3.0A, 20.0V = 5.0A USB-C1/C2: PPS 3.30-21.0V = 5.0A 100.0W MAX USB-A1/A2 QC3.0: 5.0V = 3.0A, 9.0V = 2.0A, 12.0V = 1.5A, 18.0W MAX
Output current	Multi Port: USB-C1+USB-C2: 65.0W+30.0W USB-C1+USB-C2+USB-A1/A2: 45.0W+30.0W+18.0W (QC3.0) USB-C1/USB-C2+USB-A1+USB-A2: 65.0W+18.0W (NO QC3.0) USB-C1+USB-C2+USB-A1+USB-A2: 45.0W+30.0W+18.0W (NO QC3.0)
Output power	100.0W MAX

Average active efficiency	Multi Port: USB-C1+USB-C2+USB-A1+USB-A2: (5.0V = 3.0A+5.0V = 3.0A+5.0V = 1.8A+5.0V = 1.8A):87.38% USB-C1+USB-C2+USB-A1: (20.0V = 2.25A+20.0V = 1.5A+12.0V = 1.5A):88.92% Single Port: USB-C1: 20.0V = 5.0A:90.16% USB-C1: 21.0V = 4.76A:90.33%
Efficiency at low load (10 %)	Multi Port: USB-C1+USB-C2+USB-A1+USB-A2: (5.0V = 3.0A+5.0V = 3.0A+5.0V = 1.8A+5.0V = 1.8A):84.30% USB-C1+USB-C2+USB-A1: (20.0V = 2.25A+20.0V = 1.5A+12.0V = 1.5A):81.36% Single Port: USB-C1: 20.0V = 5.0A:80.82% USB-C1: 21.0V = 4.76A:85.28%
No-load power consumption	0.094W

Above information can be found at importer website www.targus.com

Targus®

Supplier's Declaration of Conformity



Manufacturer/ Targus International LLC Tel: 1-714-765-5555
 Responsible Party : 1211 North Miller Street, Fax: 1-714-765-5599
 Address : Anaheim, CA 92806 USA Internet: www.targus.com

Hereby declares that the Product

Trade name: Targus

Product name: GaN AC Travel Adapter

Model number(Reg#): APA109

Conforms to the following specifications

FCC CFR Title 47 Part 15 Subpart B and ANSI C63.4-2014 standard limits
 The test data & results are referred to the test report Number: 2205240225ZM-001

Supplementary Information:

This device complies with part 15 of the FCC Rules. Operation is subject to the following two conditions: (1) This device may not cause harmful interference, and (2) this device must accept any interference received, including interference that may cause undesired operation.

Director, Targus International LLC Ngho,CF
 Function Title Name

7/28/2022 / Hong Kong
 Date Signed for and on behalf of Targus

Targus®



Declaration of Conformity

Manufacturer: Targus International LLC Tel: 1-714-765-5555
 Address : 1211 North Miller Street, Fax: 1-714-765-5599
 Anaheim, CA 92806 USA Internet: www.targus.com
 Importer: Targus Europe Limited Tel: +44 (0)20 8831 2000
 Address: Fourth Floor One London Road
 Staines, TW18 4EX, UK

We herewith confirm the following designated product GaN AC Travel Adapter, Model No. APA109.

Brand name "TARGUS", complies with below UK legislation and relevant standards.

For the evaluation regarding the below legislation, the following standards were applied:

Electromagnetic Compatibility Regulations 2016

EN 55022:2015+A1:2020

EN IEC 61000-3-2:2019+A1:2021

EN 61000-3-3:2015+A2:2021

EN 55025:2017+A1:2020

Electrical Equipment (Safety) Regulations 2016

BS EN IEC 62368-1:2020+A11:2020

The Eco-design for Energy-Related Products and Energy Information (Amendment) (EU) Ecu

Regulation 2019

EN 50563:2011 + A1:2013

The Restriction of the Use of Certain Hazardous Substances in Electrical and Electronic Equipment

Regulation 2012

EN IEC 63000:2018

This declaration of conformity is issued under the sole responsibility of the manufacturer.

Director, Targus - Global Sourcing Group CF Ngho
 Function Title Name

7/28/2022 / Hong Kong
 Date Signed for and on behalf of Targus

Targus®



Declaration of Conformity

Manufacturer: Targus International LLC Tel: 1-714-765-5555
 Address : 1211 North Miller Street, Fax: 1-714-765-5599
 Anaheim, CA 92806 USA Internet: www.targus.com
 Importer: Targus Europe Ltd. Tel: +44 (0)20 8831 2000
 Address: Targus EMEA Account Management,
 Van Hilbstrat 19, 5145 RK Waalwijk,
 NETHERLANDS

We herewith confirm the following designated product GaN AC Travel Adapter, Model No. APA109

Brand name "TARGUS", complies with the Low Voltage Directive 2014/33/EU, Commission

Regulation (EU) 2019/1782 of EUP Directive 2009/125/EC, EMC Directive 2014/30/EU, EU ROHS

Directive 2011/65/EU and its amendment Directive (EU) 2015/863

For the evaluation regarding the above Directives, the following standards were applied:

Low Voltage Directive: 2014/33/EU

EN IEC 62368-1:2020+A11:2020

EMC Directive: 2014/30/EU

EN 55022:2015+A1:2020

EN IEC 61000-3-2:2019+A1:2021

EN 61000-3-3:2015+A2:2021

EN 55025:2017+A1:2020

EUP Directive: COMMISSION REGULATION (EU) 2019/1782

RoHS Directive: 2011/65/EU and its amendment Directive (EU) 2015/863

EN IEC 63000:2018

You to begin CE marking: 2022

Director, Targus - Global Sourcing Group CF Ngho
 Function Title Name

7/28/2022 / Hong Kong
 Date Signed for and on behalf of Targus

DE Einleitung

Dieses Wandladergerät mit GaN-Technologie und austauschbaren Steckern für den internationalen Einsatz ermöglicht das Laden mehrerer Geräte gleichzeitig: Laptops, Tablets, Smartphones und andere USB-betriebene Geräte von verschiedenen Marken, darunter Apple, Dell, Google, Lenovo, Samsung und weitere.

Inhalt

- Targus 100 W GaN AC-Reiseadapter
- US, EU, GB, AU - AC-Stecker
- Bedienungsanleitung

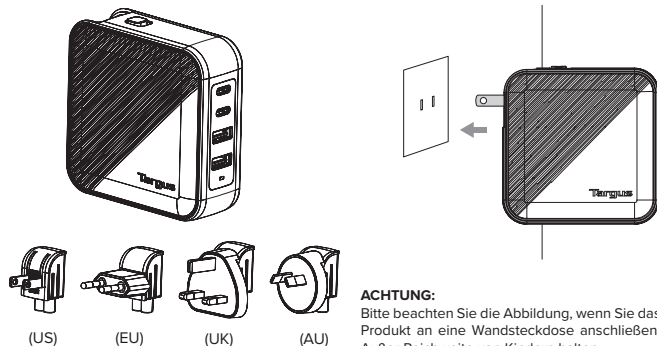
**ACHTUNG:**

Bitte beachten Sie die Abbildung, wenn Sie das Produkt an eine Wandsteckdose anschließen. Außer Reichweite von Kindern halten.

Elektrische Nennwerte

Eingangslleistung: 100 - 240VAC 1,8 A MAX 50/60 Hz

Ausgangsleistung:

Ein Port:

USB-C1/C2 PD: 5,0 V/9,0 V/12,0 V/15,0 V = 3,0 A, 20,0 V = 5,0 A

USB-C1/C2: PPS 3,30-21,0 V = 5,0 A 100,0 W MAX

USB-A1/A2 QC3,0: 5,0 V = 3,0 A, 9,0 V = 2,0 A, 12,0 V = 1,5 A, 18,0 W MAX

Mehrere Ports:

USB-C1+USB-C2: 65,0 W+30,0 W

USB-C1+USB-C2+USB-A1/A2: 45,0 W+30,0 W+18,0 W (QC3,0)

USB-C1/C2+USB-A1+USB-A2: 65,0 W+18,0 W (NO QC3,0)

USB-C1+USB-C2+USB-A1+USB-A2: 45,0 W+30,0 W+18,0 W (NO QC3,0)

Insgesamt: Max. 100,0 W

Benutzung

Punkt	Anforderungen
Betriebstemperatur	0 °C bis 35 °C
Lagertemperatur	-20 °C bis 85°C
Luftfeuchtigkeit	20 % bis 80 %, nicht kondensierend
Lagerluftfeuchtigkeit	5 % bis 95 %, nicht kondensierend
Höhe bei langfristigem Betrieb	Unter 5.000 m
Lagerhöhe	Unter 15.000 m

WICHTIGE HINWEISE ZUM AUSTAUSCHEN DER AUSTAUSCHBAREN AC-STECKER

Vorgehensweise:

1. Stellen Sie vor dem Gebrauch sicher, dass Sie den passenden austauschbaren AC-Stecker verwenden.

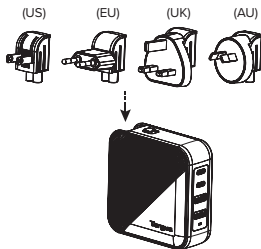

2. Schieben Sie zum Austauschen der austauschbaren AC-Stecker (US AC-Stecker als Beispiel zur Veranschaulichung der Vorgehensweise) zuerst den oberen Hebel nach vorne und entfernen Sie dann den Stecker.

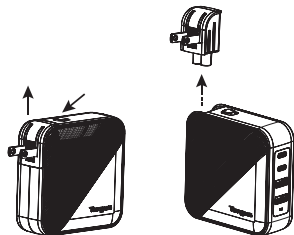

3. Befestigen Sie den AC-Stecker, der zu dem Land passt, in dem Sie sich aufhalten.

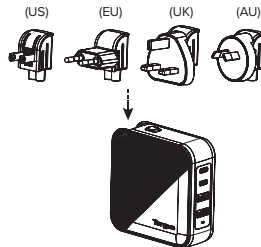

VOR DEM GEBRAUCH ALLE ANLEITUNGEN LESEN

WICHTIGE SICHERHEITSHINWEISE

Sicherheitsvorkehrungen

1. Stellen Sie immer sicher, dass die Nenneingangsspannung des Wandladegeräts mit der Steckdose, die Sie benutzen möchten, kompatibel ist.
2. Das Wandladegerät muss vollständig in die Steckdose geschoben werden. Verwenden Sie das Wandladegerät niemals, wenn der Steckerkontakt oder -Pin freiliegt.
3. Vergewissern Sie sich, ob der austauschbare Stecker für das Land, in dem Sie sich befinden, geeignet ist, bevor Sie ihn in die Steckdose stecken.
4. Berühren Sie niemals einen der Metallteile, wenn das Wandladegerät in Gebrauch ist.
5. Das Produkt ist nur für den Gebrauch in Innenbereichen ausgelegt.
6. Benutzen Sie die AC-Stecker nicht mehr, wenn sich der Metall-Pin verformt oder sich gelockert hat.

Wenn beide USB-A-Ports verbunden sind, wird die QC3.0-Funktion deaktiviert.

Ausgangsleistung eines Ports:

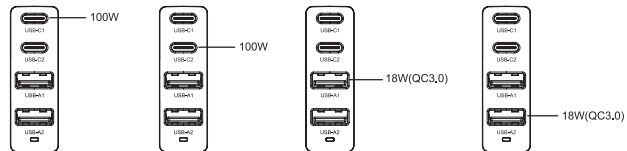

Ausgangsleistung von zwei Ports:

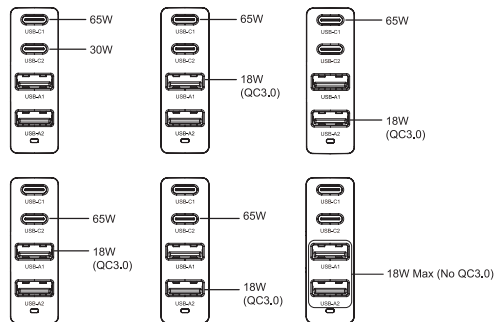

Ausgangsleistung von drei Ports:

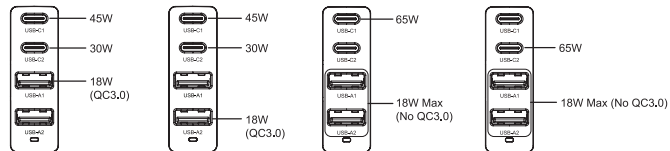

Ausgangsleistung aller Ports:

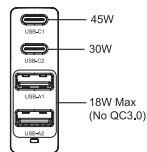

Informationen zur externen Stromversorgung

Hersteller	Targus International LLC
Adresse	1211 North Miller Street, Anaheim, CA 92806 USA
Handelsregister-nummer	5892659
Modell/Reg	APA109
Eingangsspannung	100 - 240 V \sim
Eingangs-AC-Frequenz	50/60 Hz
Ausgangsspannung	Ein Port: USB-C1/C2 PD: 5,0 V/9,0 V/12,0 V/15,0 V = 3,0 A, 20,0 V = 5,0 A USB-C1/C2: PPS 3,30-21,0 V = 5,0 A 100,0 W max. USB-A1/A2 QC3.0: 5,0 V = 3,0 A, 9,0 V = 2,0 A, 12,0 V = 1,5 A, 18,0 W max.
Ausgangsstrom	Mehrere Ports: USB-C1+USB-C2: 65,0 W + 30,0 W USB-C1+USB-C2+USB-A1/A2: 45,0 W + 30,0 W + 18,0 W (QC3.0) USB-C1/USB-C2+USB-A1+USB-A2: 65,0 W + 18,0 W (NO QC3.0) USB-C1+USB-C2+USB-A1+USB-A2: 45,0 W + 30,0 W + 18,0 W (NO QC3.0)
Ausgangsleistung	Max. 100,0 W

Durchschnittliche aktive Effizienz	Mehrere Ports: USB-C1+USB-C2+USB-A1+USB-A2: (5,0 V = 3,0 A + 5,0 V = 3,0 A + 5,0 V = 1,8 A + 5,0 V = 1,8 A): 87,38 % USB-C1+USB-C2+USB-A1: (20,0 V = 2,25 A + 20,0 V = 1,5 A + 12,0 V = 1,5 A): 88,92 % Ein Port: USB-C1: 20,0 V = 5,0 A: 90,16 % USB-C1: 21,0 V = 4,76 A: 90,33 %
Effizienz bei niedriger Last (10 %)	Mehrere Ports: USB-C1+USB-C2+USB-A1+USB-A2: (5,0 V = 3,0 A + 5,0 V = 3,0 A + 5,0 V = 1,8 A + 5,0 V = 1,8 A): 84,30 % USB-C1+USB-C2+USB-A1: (20,0 V = 2,25 A + 20,0 V = 1,5 A + 12,0 V = 1,5 A): 81,36 % Ein Port: USB-C1: 20,0 V = 5,0 A: 80,82 % USB-C1: 21,0 V = 4,76 A: 85,28 %
Leistungsaufnahme bei Nulllast	0,094 W

Die oben stehenden Informationen finden Sie auf der Website des Importeurs: www.targus.com

GERMAN

Targus

Konformitätserklärung

Hersteller:	Targus International LLC	Telefon:	1-714-765-5555
Adresse:	1211 North Miller Street, Anaheim, CA 92806 USA	Fax:	1-714-765-5599
Importeur:	Targus Europe Ltd.	Internet:	www.targus.com
Adresse:	Targus EMEA Account Management, Van Hilststraat 19, 5145 RK Waalwijk, NETHERLANDS	Telefon:	+44 (0) 20 8831 2000

Hiermit bestätigen wir, dass das folgende Produkt GaN AC Travel Adapter, Modellnr. APA109 Markenname „TARGUS“, der Low Voltage Directive 2014/55/EU, Commission Regulation (EU) 2019/1782, der ErP Directive 2009/125/EC, EMC Directive 2014/30/EU, EU ROHS Directive, 2011/65/EU and its amendment Directive (EU) 2015/863.

Für die Evaluierung der o. g. Richtlinien wurden folgende Standards angewendet:

Low-Voltage Directive: 2014/55/EU

EN IEC 62368-1:2020+A11:2020

EMC Directive: 2014/30/EU

EN 55032:2015+A1:2020

EN IEC 61000-3-2:2019+A1:2021

EN 61000-3-3:2013+A2:2021

EN 55035:2017+A1:2020

Erp Directive : COMMISSION REGULATION (EU) 2019/1782

RoHS Directive: 2011/65/EU and its amendment Directive (EU) 2015/863

EN IEC 63000:2018

Anfangsjahr für CE-Kennzeichen: 2022

Director, Targus - Global Sourcing Group

Funktion

7/28/2022 / Hongkong

Datum / Ausstellungsort

CF Ngho

Name

Unterzeichnet für und im Namen von Targus

FR Introduction

Ce chargeur mural doté de la technologie GaN et de fiches interchangeable pour une utilisation internationale permet la recharge simultanée de plusieurs appareils : ordinateurs portables, tablettes, smartphones et autres appareils alimentés par USB de diverses marques, notamment Apple, Dell, Google, Lenovo et Samsung.

Contenu

- Adaptateur de voyage CA 100 W GaN Targus
- Prise secteur États-Unis, UE, Royaume-Uni, AU
- Guide de l'utilisateur

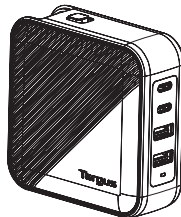

(US)



(EU)



(UK)

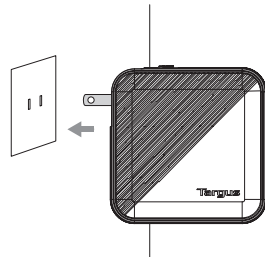

(AU)

**ATTENTION :**

Reportez-vous à l'illustration pour le branchement au mur. Gardez hors de portée des enfants.

Caractéristiques électriques

Entrée : 100 - 240 V CA 1,8A MAX 50/60 Hz

Sortie :

Port unique :

USB-C1/C2 PD : 5,0 V / 9,0 V / 12,0 V / 15,0 V = 3,0 A, 20,0 V = 5,0 A

USB-C1/C2 : PPS 3,30 - 21,0 V = 5,0 A 100,0 W MAX

USB-A1/A2 QC3,0 : 5,0 V = 3,0 A, 9,0 V = 2,0 A, 12,0 V = 1,5 A, 18,0 W MAX

Port multiple :

USB-C1 + USB-C2 : 65,0 W + 30,0 W

USB-C1 + USB-C2 + USB-A1/A2 : 45,0 W + 30,0 W + 18,0 W (QC3,0)

USB-C1/C2 + USB-A1 + USB-A2 : 65,0 W + 18,0 W (NO QC3,0)

USB-C1 + USB-C2 + USB-A1 + USB-A2 : 45,0 W + 30,0 W + 18,0 W (NO QC3,0)

Total : 100,0 W MAX.

Fonctionnement

Article	Configuration requise
Température de fonctionnement	0 °C à 35 °C
Température de stockage	-20 °C à 85 °C
Humidité relative	20 % à 80 %, sans condensation
Humidité de stockage	5 % à 95 %, sans condensation
Altitude à long terme	Moins de 5000 m
Altitude de stockage	Moins de 15000 m

INSTRUCTIONS IMPORTANTES CONCERNANT LE CHANGEMENT DES FICHES AC INTERCHANGEABLES**Procédures :**

1. Vérifiez la fiche CA interchangeable appropriée avant de l'utiliser.

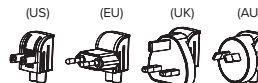

2. Lorsque vous changez la fiche CA interchangeable (la fiche CA américaine est prise comme exemple pour illustrer les procédures), faites d'abord glisser le levier supérieur vers l'avant et retirez-le.

3. Insérez la fiche CA interchangeable appropriée pour le pays dans lequel vous vous trouvez.

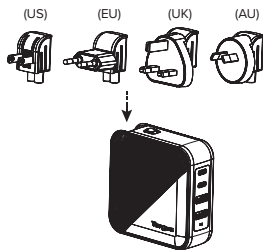

LISEZ TOUTES LES INSTRUCTIONS AVANT L'UTILISATION

INSTRUCTIONS DE SÉCURITÉ IMPORTANTES

Précautions de sécurité

1. Assurez-vous toujours que la tension d'entrée nominale du chargeur mural est compatible avec la prise que vous comptez utiliser.
2. Le chargeur mural doit être entièrement inséré dans la prise. N'utilisez jamais le chargeur mural si la broche ou la lame est exposée.
3. Vérifiez que la fiche CA interchangeable est appropriée pour le pays dans lequel vous vous trouvez, avant de la brancher dans la prise.
4. Ne touchez jamais une partie métallique du chargeur mural lorsqu'il est utilisé.
5. Le produit est conçu pour une utilisation en intérieur uniquement.
6. Si la broche métallique des fiches CA se déforme ou se détache, cessez d'utiliser l'appareil.

Si les deux ports USB-A sont connectés, la fonction QC3.0 sera désactivée.

Port unique de sortie :

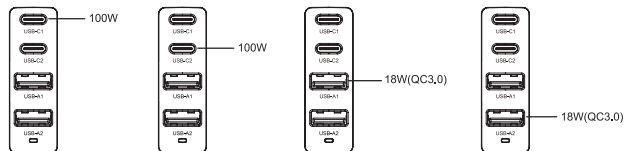

Ports doubles de sortie :

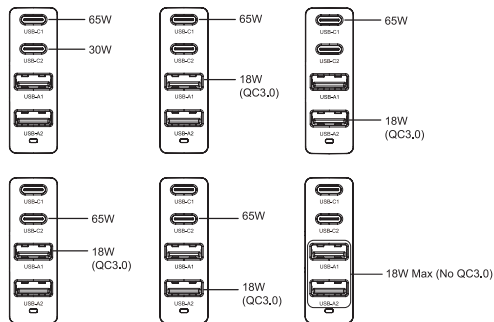

Ports triples de sortie :

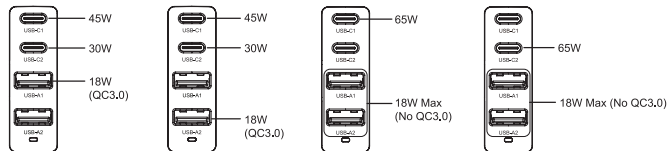

Tous les ports de sortie :

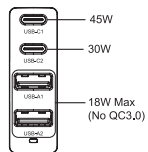

Informations sur l'alimentation externe

Fabricant	Targus International LLC
Adresse	1211 North Miller Street, Anaheim, Californie 92806 États-Unis
Commercial Numéro d'enregistrement	5892659
Modèle / Reg	APA109
Tension d'entrée	100-240 V [~]
Fréquence CA d'entrée	50 / 60 Hz
Tension de sortie	Port unique : USB-C1 / C2 PD : 5,0 V / 9,0 V / 12,0 V / 15,0 V = 3,0 A, 20,0 V = 5,0 A USB-C1 / C2 : PPS 3,30 - 21,0 V = 5,0 A 100,0 W MAX USB-A1 / A2 QC3,0 : 5,0 V = 3,0 A, 9,0 V = 2,0 A, 12,0 V = 1,5 A, 18,0 W MAX
Courant de sortie	Port multiple : USB-C1 + USB-C2 : 65,0 W + 30,0 W USB-C1 + USB-C2 + USB-A1/A2 : 45,0 W + 30,0 W + 18,0 W (QC3,0) USB-C1 / USB-C2 + USB-A1 + USB-A2 : 65,0 W + 18,0 W (NO QC3,0) USB-C1 + USB-C2 + USB-A1 + USB-A2 : 45,0 W + 30,0 W + 18,0 W (NO QC3,0)
Puissance de sortie	100,0 W MAX.

Rendement actif moyen	<p>Port multiple : USB-C1 + USB-C2 + USB-A1 + USB-A2 : (5,0 V = 3,0 A + 5,0 V = 3,0 A + 5,0 V = 1,8 A + 5,0 V = 1,8 A) : 87,38 %</p> <p>USB-C1 + USB-C2 + USB-A1 : (20,0 V = 2,25 A + 20,0 V = 1,5 A + 12,0 V = 1,5 A) : 88,92 %</p> <p>Port unique : USB-C1 : 20,0 V = 5,0 A : 90,16 % USB-C1 : 21,0 V = 4,76 A : 90,33 %</p>
Rendement à faible charge (10 %)	<p>Port multiple : USB-C1 + USB-C2 + USB-A1 + USB-A2 : (5,0 V = 3,0 A + 5,0 V = 3,0 A + 5,0 V = 1,8 A + 5,0 V = 1,8 A) : 84,30 %</p> <p>USB-C1 + USB-C2 + USB-A1 : (20,0 V = 2,25 A + 20,0 V = 1,5 A + 12,0 V = 1,5 A) : 81,36 %</p> <p>Port unique : USB-C1 : 20,0 V = 5,0 A : 80,82 % USB-C1 : 21,0 V = 4,76 A : 85,28 %</p>
Consommation d'énergie à vide	0,094 W

Les informations ci-dessus sont disponibles sur le site Web de l'importateur www.targus.com.

FRENCH



Déclaration de conformité

Fabricant :	Targus International LLC	Tel :	1-714-765-5555
Adresse :	1211 North Miller Street, Anaheim, CA 92806 USA	Fax :	1-714-765-5599
Importateur :	Targus Europe Ltd.	Internet :	www.targus.com
Adresse :	Targus EMEA Account Management, Van Hilststraat 19, 5145 RK Waalwijk, NETHERLANDS	Tel :	+44 (0)20 8831 2000

Nous confirmons par les présentes que le produit désigné ci-après GaN AC Travel Adapter, Numéro de référence ΔPA102 Nom de marque « TARGUS », est conforme à Low Voltage Directive 2014/35/EU, Commission Regulation (EU) 2019/1782 de ErP Directive 2009/125/EC, EMC Directive 2014/50/EU, EU ROHS Directive 2011/65/EU and its amendment Directive (EU) 2015/863.

Pour l'évaluation relative aux Directives susmentionnées, les standards suivants ont été appliqués :

Low-Voltage Directive: 2014/35/EU
 EN IEC 62368-1:2020+A11:2020
 EMC Directive: 2014/50/EU
 EN 55032:2015+A1:2020
 EN IEC 61000-3-2:2019+A1:2021
 EN 61000-3-3:2013+A2:2021
 EN 55035:2017+A11:2020

Erp Directive : COMMISSION REGULATION (EU) 2019/1782
 RoHS Directive: 2011/65/EU and its amendment Directive (EU) 2015/863
 EN IEC 63000:2018
 Année de début du marquage CE : 2022

Directeur, Targus - Global Sourcing Group	CF Ngho
Intitulé de la fonction	Nom

7/28/2022 / Hong Kong

Date / Lieu



Signé pour et au nom de Targus

CZ Úvod

Tato nástěnná nabíječka s technologií GaN a zaměnitelnými zástrčkami pro mezinárodní použití umožňuje současné nabíjení více zařízení notebooků, tabletů, smartphonů a dalších zařízení napájených přes USB od různých značek, včetně Apple, Dell, Google, Lenovo, Samsung a dalších.

Obsah

- Cestovní adaptér Targus 100W GaN AC
- US, EU, UK, AU - Střídavá zástrčka
- Uživatelská příručka

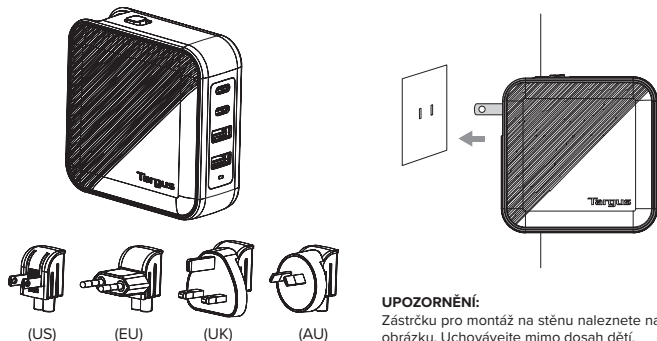
**Elektrická třída**

Vstup: 100 - 240VAC 1,8 A MAX 50/60 Hz

Ausgangsleistung:

Jeden port:

USB-C1/C2 PD: 5,0 V/9,0 V/12,0 V/15,0 V = 3,0 A, 20,0 V = 5,0 A

USB-C1/C2: PPS 3,30-21,0 V = 5,0 A 100,0 W MAX

USB-A1/A2 QC3,0: 5,0 V = 3,0 A, 9,0 V = 2,0 A, 12,0 V = 1,5 A, 18,0 W MAX

Více portů:

USB-C1+USB-C2: 65,0 W+30,0 W

USB-C1+USB-C2+USB-A1/A2: 45,0 W+30,0 W+18,0 W (QC3,0)

USB-C1/C2+USB-A1+USB-A2: 65,0 W+18,0 W (NO QC3,0)

USB-C1+USB-C2+USB-A1+USB-A2: 45,0 W+30,0 W+18,0 W (NO QC3,0)

ICelkem: 100,0 W MAX

Provoz

Položka	Požadavky
Provozní teplota	0 °C až 35 °C
Teplota skladování	-20 °C až 85 °C
Relativní vlhkost	20 % až 80 %, nekondenzující
Skladovací vlhkost	5 % až 95 %, nekondenzující
Dlouhodobá nadmořská výška	Méně než 5 000 m
Skladovací nadmořská výška	Méně než 15 000 m

DŮLEŽITÉ POKYNY PRO VÝMĚNU VÝMĚNNÝCH STŘÍDAVÝCH ZÁSTRČEK

Postupy:

1. Před použitím si ověřte příslušnou vyměnitelnou střídavou zástrčku.

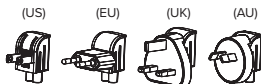

2. Při výměně zaměnitelné střídavé zástrčky (US střídavá zástrčka jako příklad pro ilustraci postupů) posuňte nejprve horní páčku dopředu a vyjměte ji.

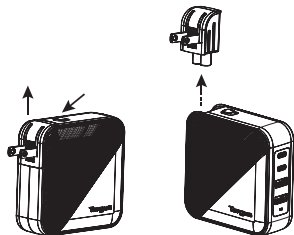

3. Zasuňte příslušnou zaměnitelnou střídavou zástrčku pro zemi, ve které se nacházíte.

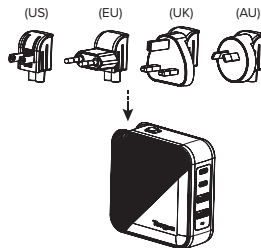

PŘED POUŽITÍM SI PŘEČTĚTE VŠECHNY POKYNY

DŮLEŽITÉ BEZPEČNOSTNÍ POKYNY

Bezpečnostní opatření

1. Vždy se ujistěte, že jmenovité vstupní napětí nástěnné nabíječky je kompatibilní se zásuvkou, kterou hodláte použít.
2. Nástěnná nabíječka musí být zcela zasunuta do zásuvky. Nikdy nepoužívejte nástěnnou nabíječku, pokud je kolík nebo čepel odkrytá.
3. Před zapojením do zásuvky se ujistěte, že je zaměnitelná střídavá zástrčka vhodná pro zemi, ve které se nacházíte.
4. Nikdy se nedotýkejte žádné kovové části nástěnné nabíječky, když je používána.
5. Výrobek je určen pouze pro vnitřní použití.
6. Pokud se kovový kolík zástrčky střídavého proudu zdeformuje nebo uvolní, přestaňte zástrčku používat.

Pokud jsou připojeny oba porty USB-A, funkce QC3.0 bude vypnuta

Výstupní jednotný port:

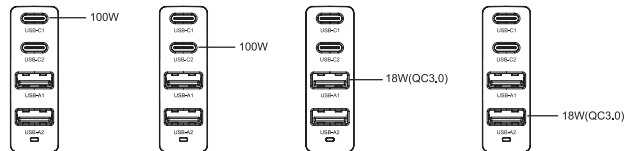

Výstupní duální porty:

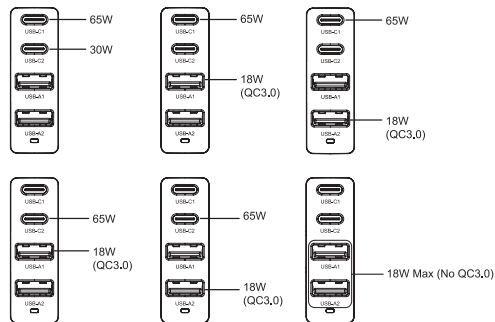

Výstupní tři porty:

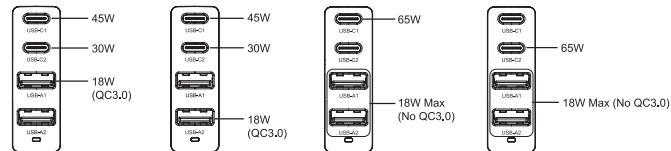

Výstup Všechny porty:

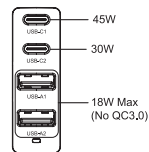

Informace o externím napájení

Výrobce	Targus International LLC
Adresa	1211 North Miller Street, Anaheim, CA 92806 USA
Obchodní Registrační číslo	5892659
Model/regulace	APA109
Vstupní napětí	100–240 V [~]
Vstupní frekvence střídavého proudu	50/60Hz
Výstupní napětí	Jeden port: USB-C1/C2 PD: 5,0 V / 9,0 V / 12,0 V / 15,0 V = 3,0 A, 20,0 V = 5,0 A USB-C1/C2: PPS 3,30–21,0 V = 5,0 A 100,0 W MAX USB-A1/A2 QC3.0: 5,0 V = 3,0 A, 9,0 V = 2,0 A, 12,0 V = 1,5 A, 18,0 W MAX
Výstupní proud	Více portů: USB-C1+USB-C2: 65,0 W + 30,0 W USB-C1+USB-C2+USB-A1/A2: 45,0 W + 30,0 W + 18,0 W (QC3.0) USB-C1/USB-C2+USB-A1+USB-A2: 65,0 W + 18,0 W (BEZ QC3.0) USB-C1+USB-C2+USB-A1+USB-A2: 45,0 W + 30,0 W + 18,0 W (BEZ QC3.0)
Výstupní výkon	100,0 W MAX

Průměrná aktivní účinnost	Více portů: USB-C1+USB-C2+USB-A1+USB-A2: (5,0 V = 3,0 A + 5,0 V = 3,0 A + 5,0 V = 1,8 A + 5,0 V = 1,8 A): 87,38 % USB-C1+USB-C2+USB-A1: (20,0 V = 2,25 A + 20,0 V = 1,5 A + 12,0 V = 1,5 A): 88,92 % Jeden port: USB-C1: 20,0 V = 5,0 A: 90,16 % USB-C1: 21,0 V = 4,76 A: 90,33 %
Účinnost při nízkém zatížení (10 %)	Více portů: USB-C1+USB-C2+USB-A1+USB-A2: (5,0 V = 3,0 A + 5,0 V = 3,0 A + 5,0 V = 1,8 A + 5,0 V = 1,8 A): 84,30 % USB-C1+USB-C2+USB-A1: (20,0 V = 2,25 A + 20,0 V = 1,5 A + 12,0 V = 1,5 A): 81,36 % Jeden port: USB-C1: 20,0 V = 5,0 A: 80,82 % USB-C1: 21,0 V = 4,76 A: 85,28 %
Spotřeba energie bez zatížení	0,094 W

Výše uvedené informace naleznete na webových stránkách dovozce www.targus.com

DK Introduktion

Denne oplader bruger teknologien GaN og er udstyret med udskiftelige stik til international brug, så du kan oplade flere enheder ad gangen, såsom bærbare computere, tabletter, mobiltelefoner og andre USB-drevne enheder af forskellige mærker, såsom Apple, Dell, Google, Lenovo, Samsung og andre.

Indhold

- Targus 100W GaN AC rejseadapter
- US, EU, UK, AU - vekselstrømsstik (AC)
- Brugsvejledning

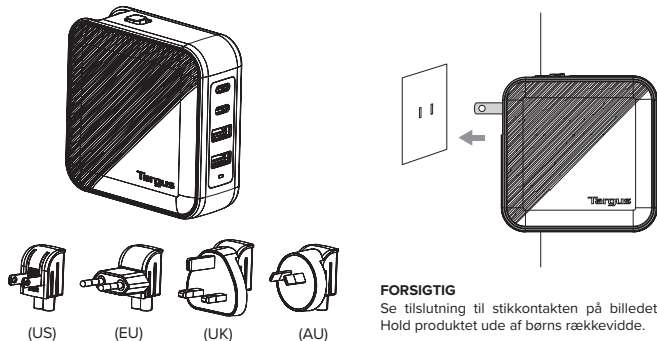
**FORSIGTIG**

Se tilslutning til stikkontakten på billedet.
Hold produktet ude af børns rækkevidde.

EI-klassificering

Indgang: 100 - 240VAC 1.8A MAX 50/60Hz

Udgang:

Enkelt port:

USB-C1/C2 PD: 5.0V/9.0V/12.0V/15.0V = 3.0A, 20.0V = 5.0A

USB-C1/C2: PPS 3.30-21.0V = 5.0A 100.0W MAX

USB-A1/A2 QC3.0: 5.0V = 3.0A, 9.0V = 2.0A, 12.0V = 1.5A, 18.0W MAX

Flere porte:

USB-C1+USB-C2: 65.0W+30.0W

USB-C1+USB-C2+USB-A1/A2: 45.0W+30.0W+18.0W (QC3.0)

USB-C1/C2+USB-A1+USB-A2: 65.0W+18.0W (NO QC3.0)

USB-C1+USB-C2+USB-A1+USB-A2: 45.0W+30.0W+18.0W (NO QC3.0)

I alt: 100,0W MAKS.

Drift

Del	Krav
Driftstemperatur	0°C til 35°C
Opbevaringstemperatur	-20°C til 85°C
Relativ luftfugtighed	20% til 80%, ikke-kondenserende
Opbevaringsfugtighed	5% til 95%, ikke-kondenserende
Driftshøjde	Under 5000 meter
Opbevaringshøjde	Under 15000 meter

VIGTIGE INSTRUKTIONER TIL SKIFT AF VEKSELSTRØMSSTIKKENE

Fremgangsmåde:

1. Sørg for, at du har det rigtige udskiftelige vekselstrømsstik før brug.

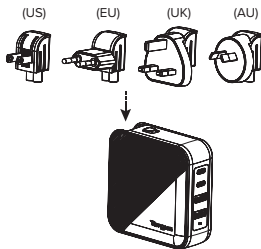

2. Når strømstikket skiftes (fremgangsmåden, der er vist på billederne, bruger et vekselstrømsstik fra USA), skal du først trykke håndtaget foroven fremad og tage det af.

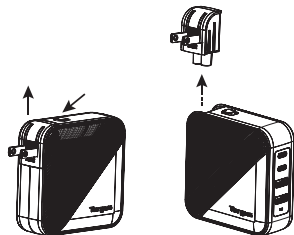

3. Tryk strømstikket, der bruges i landet du befinder dig i, på.

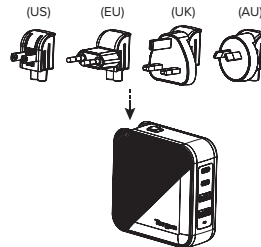

LÆS ALLE INSTRUKTIONER FØR BRUG

VIGTIGE SIKKERHEDSINSTRUKTIONER

Sikkerhedsforanstaltninger

1. Sørg altid for, at vægopladerens nominelle indgangsspænding passer med stikkontakten, du bruger.
2. Vægopladeren skal sættes helt ind i stikkontakten. Brug aldrig en vægoplader, hvis den er beskadiget.
3. Sørg for, at det udskiftelige strømstik passer til stikkontakten i landet, du befinder dig i, før det sættes i stikkontakten.
4. Rør aldrig nogen metal del på vægopladeren, når den er i brug.
5. Produktet er kun beregnet til indendørs brug.
6. Hvis stikbenet på strømstikkene deformeres eller er løse, må produktet ikke bruges.

Hvis begge USB-A-porte bruges, slås QC3.0 fra

Forsyning på én port:

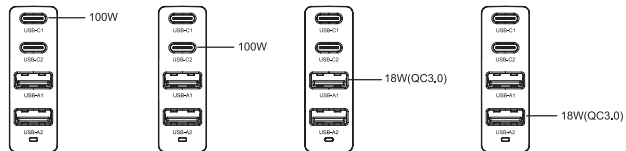

Forsyning på begge porte:

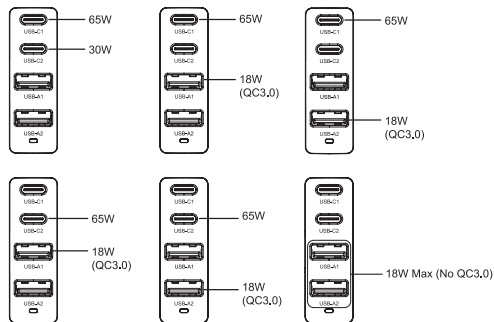

Forsyning på tre porte:

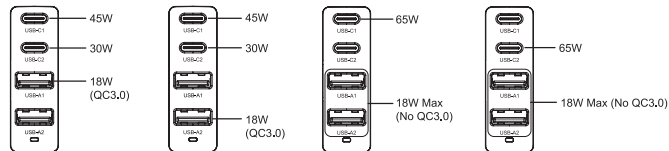

Forsyning på alle porte:

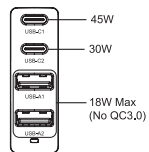

Oplysninger om ekstern strømforsyning

Producent	Targus International LLC
Adresse	1211 North Miller Street, Anaheim, CA 92806 USA
Kommerciel Registreringsnummer	5892659
Model/Registreringsnummer	APA109
Indgangsspænding	100-240V~
Vekselstrømsspænding på indgang	50/60Hz
Spænding på udgang	USB-C1/C2 PD: 5,0V/9,0V/12,0V/15,0V = 3,0A, 20,0V = 5,0A USB-C1/C2: PPS 3.30-21,0V = 5,0A 100,0W MAKS. USB-A1/A2 QC3.0: 5,0V = 3,0A, 9,0V = 2,0A, 12,0V = 1,5A, 18,0 W MAKS.
Strøm på udgang	Flere porte: USB-C1+USB-C2: 65,0W + 30,0W USB-C1 + USB-C2 + USB-A1/A2: 45,0W + 30,0W + 18,0W (QC3.0) USB-C1/USB-C2 + USB-A1 + USB-A2: 65,0W + 18,0W (NO QC3.0) USB-C1+USB-C2+USB-A1+USB-A2: 45,0W + 30,0W+18,0W (INGEN QC3.0)
Effekt på udgang	100,0W MAKS.

Gennemsnitlig aktiv effektivitet	Flere porte: USB-C1+USB-C2+USB-A1+USB-A2: (5,0V = 3,0A + 5,0V = 3,0A + 5,0V = 1,8A + 5,0V = 1,8A): 87,38% USB-C1 + USB-C2 + USB-A1: (20,0V = 2,25A + 20,0V = 1,5A + 12,0V = 1,5A): 88,92% Enkelt port: USB-C1: 20,0V = 5,0A: 90,16% USB-C1: 21,0V = 4,76A: 90,33%
Effektivitet ved lav belastning (10 %)	Flere porte: USB-C1+USB-C2+USB-A1+USB-A2: (5,0V = 3,0A + 5,0V = 3,0A + 5,0V = 1,8A + 5,0V = 1,8A): 84,30% USB-C1 + USB-C2 + USB-A1: (20,0V = 2,25A + 20,0V = 1,5A + 12,0V = 1,5A): 81,36% Enkelt port: USB-C1: 20,0V = 5,0A: 80,82% USB-C1: 21,0V = 4,76A: 85,28%
Strømforbrug, når produktet ikke bruges	0.094W

Ovenstående oplysninger kan findes på importørens hjemmeside www.targus.com

FI Esittely

Tämä seinälaturi, jossa on GaN-tekniikka ja vaihdettavat pistokkeet kansainvälistä käyttöä varten, mahdollistaa useiden kannettavien tietokoneiden, tablettien, älypuhelimien ja muiden USB-virtaa käyttävien laitteiden eri tuotemerkeiltä, kuten Apple, Dell, Google, Lenovo, Samsung ja muut, samanaikaisen lataamisen.

Sisältö

- Targus 100 W GaN AC-matkasovitin
- US-, EU-, UK-, AU-vaihtovirtapistoke
- Käyttöopas

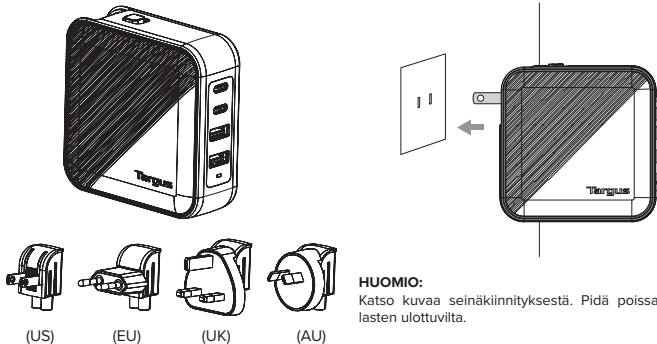
**Sähköluokitus**

Tulo: 100 - 240VAC 1.8A MAX 50/60Hz

Lähtö:

Yksi portti:

USB-C1/C2 PD: 5.0V/9.0V/12.0V/15.0V = 3.0A, 20.0V = 5.0A

USB-C1/C2: PPS 3.30-21.0V = 5.0A 100.0W MAX

USB-A1/A2 QC3.0: 5.0V = 3.0A, 9.0V = 2.0A, 12.0V = 1.5A, 18.0W MAX

Monta porttia:

USB-C1+USB-C2: 65.0W+30.0W

USB-C1+USB-C2+USB-A1/A2: 45.0W+30.0W+18.0W (QC3.0)

USB-C1/C2+USB-A1+USB-A2: 65.0W+18.0W (NO QC3.0)

USB-C1+USB-C2+USB-A1+USB-A2: 45.0W+30.0W+18.0W (NO QC3.0)

Yhteensä: 100,0 W MAKS.

Käyttö

Kohta	Vaativuudet
Käyttölämpötila	0–35 °C
Säilytyslämpötila	-20–85 °C
Suhteellinen kosteus	20–80 %, tiivistymätöntä
Säilytystilan kosteus	5–95 %, tiivistymätöntä
Pitkäaikainen korkeus	Alle 5000 m
Säilytystilan korkeus	Alle 15000 m

TÄRKEITÄ OHJEITA VAIHDETTAVIEN VAIHTOVIRTAPISTOKKEIDEN VAIHTAMISESTA

Toimenpiteet:

1. Varmista sopiva vaihdettava vaihtovirtapistoke ennen käyttöä.

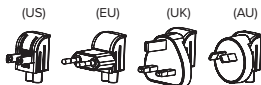

2. Kun vaihdat vaihdettavaa vaihtovirtapistoketta (Yhdysvaltain vaihtovirtapistoke esimerkkinä toimenpiteiden kuvaamiseksi), liu'uta ylävipu ensin eteenpäin ja irrota pistoke.

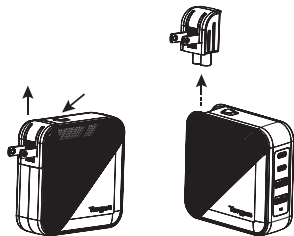

3. Liu'uta paikalleen omaan maasi sopiva vaihdettava vaihtovirtapistoke.

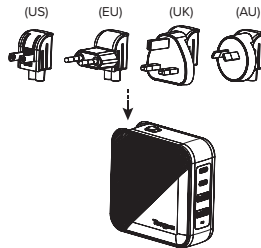

LUE KAIKKI OHJEET ENNEN KÄYTTÖÄ

TÄRKEITÄ TURVALLISUUSOHJEITA

Varotoimenpiteet

1. Varmista aina, että seinälaturin nimellinen tulojännite on yhteensopiva sen pistorasian kanssa, jota aiot käyttää.
2. Seinälaturin on oltava kokonaan pistorasiassa. Älä koskaan käytä seinälaturia, jos tappi tai terä on paljaana.
3. Varmista ennen pistorasiaan kytkemistä, että vaihdettava vaihtovirtapistoke sopii maahan, jossa olet.
4. Älä koskaan koske seinälaturin metalliosiin, kun se on käytössä.
5. Tuote on suunniteltu vain sisäkäyttöön.
6. Jos vaihtovirtapistokkeen metallitappi on epämuodostunut tai löystynyt, lopeta käyttö.

Jos molemmat USB-A-portit on liitetty, QC3.0-ominaisuus ei ole käytössä

Lähtö yksi portti:

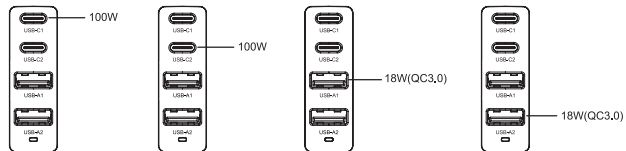

Lähtö kaksi porttia:

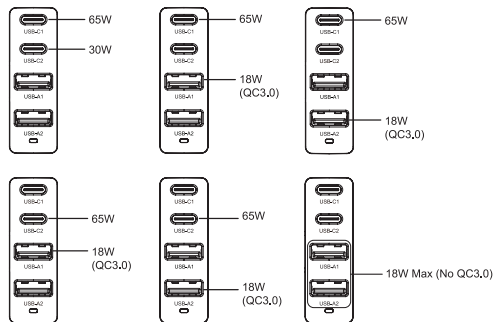

Lähtö kolme porttia:

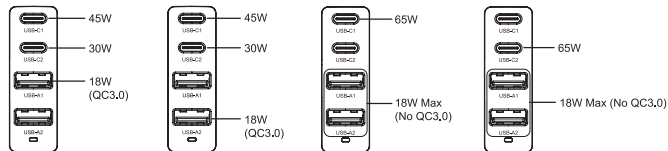

Lähtö kaikki portit:

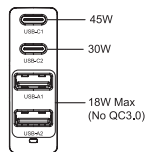

Ulkoisen virtalähteen tiedot

Valmistaja	Targus International LLC
Osoite	1211 North Miller Street, Anaheim, CA 92806 USA
Kaupallinen rekisterinumero	5892659
Malli/rek	APA109
Tulojännite	100–240 V [~]
AC-taajuus tulo	50/60 Hz
Lähtöjännite	Yksi portti: USB-C1/C2 PD: 5,0 V / 9,0 V / 12,0 V / 15,0 V = 3,0 A, 20,0 V = 5,0 A USB-C1/C2: PPS 3,30–21,0 V = 5,0 A 100,0 W MAKS. USB-A1/A2 QC3.0: 5,0 V = 3,0 A, 9,0 V = 2,0 A, 12,0 V = 1,5 A, 18,0 W MAKS.
Lähtövirta	Monta porttia: USB-C1+USB-C2: 65,0W+30,0W USB-C1+USB-C2+USB-A1/A2: 45,0 W + 30,0 W + 18,0 W (QC3.0) USB-C1/USB-C2+USB-A1+USB-A2: 65,0 W + 18,0 W (EI QC3.0) USB-C1+USB-C2+USB-A1+USB-A2: 45,0 W + 30,0 W + 18,0 W (EI QC3.0)
Lähtöteho	100,0 W MAKS.

Keskimääräinen aktiivinen hyötysuhde	Monta porttia: USB-C1+USB-C2+USB-A1+USB-A2: (5,0 V = 3,0 A + 5,0 V = 3,0 A + 5,0 V = 1,8 A + 5,0 V = 1,8 A):87,38 % USB-C1+USB-C2+USB-A1: (20,0 V = 2,25 A + 20,0 V = 1,5 A + 12,0 V = 1,5 A):88,92 % Yksi portti: USB-C1: 20,0 V = 5,0 A:90,16 % USB-C1: 21,0 V = 4,76 A:90,33 %
Hyötysuhde alhaisella kuormituksella (10 %)	Monta porttia: USB-C1+USB-C2+USB-A1+USB-A2: (5,0 V = 3,0 A + 5,0 V = 3,0 A + 5,0 V = 1,8 A + 5,0 V = 1,8 A):84,30 % USB-C1+USB-C2+USB-A1: (20,0 V = 2,25 A + 20,0 V = 1,5 A + 12,0 V = 1,5 A):81,36 % Yksi portti: USB-C1: 20,0 V = 5,0 A:80,82 % USB-C1: 21,0 V = 4,76 A:85,28 %
Virrankulutus kuormittamattomana	0.094W

Edellä mainitut tiedot löytyvät maahantuojaan verkkosivuilta www.targus.com

GR Εισαγωγή

Ο παρών φορτιστής τοίχου διαθέτει τεχνολογία GaN και ανταλλάξιμα βύσματα για διεθνή χρήση, διευκολύνει την ταυτόχρονη φόρτιση πολλαπλών συσκευών, λάπτοπ, τάμπλετ, smartphone και άλλων συσκευών ισχύος USB από διάφορες μάρκες συμπεριλαμβανομένων των Apple, Dell, Google, Lenovo, Samsung και άλλων.

Περιεχόμενα

- Αντάπτορας ταξιδιού Targus 100W GaN AC
- Βύσμα εναλλασσόμενου ρεύματος για ΗΠΑ, ΕΕ, Ηνωμένο Βασίλειο, Αυστραλία
- Οδηγίες χρήσης

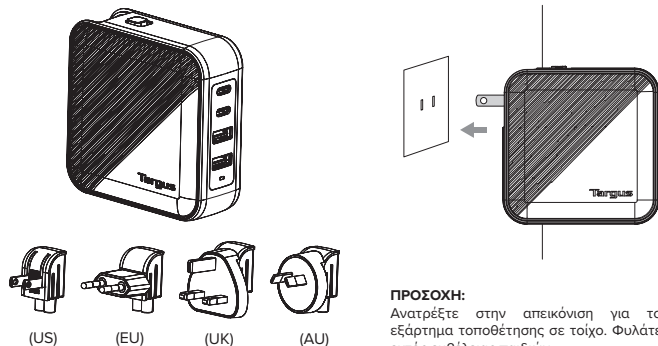
**ΠΡΟΣΟΧΗ:**

Ανατρέξτε στην απεικόνιση για το εξάρτημα τοποθέτησης σε τοίχο. Φυλάτε εκτός εμβέλειας παιδιών.

Στοιχεία ηλεκτρολογικών

Είσοδος: 100 - 240VAC 1.8A MAX 50/60Hz

Έξοδος:

Μονή θύρα:

USB-C1/C2 PD: 5.0V/9.0V/12.0V/15.0V = 3.0A, 20.0V = 5.0A

USB-C1/C2: PPS 3.30-21.0V = 5.0A 100.0W MAX

USB-A1/A2 QC3.0: 5.0V = 3.0A, 9.0V = 2.0A, 12.0V = 1.5A, 18.0W MAX

Πολλαπλή θύρα:

USB-C1+USB-C2: 65.0W+30.0W

USB-C1+USB-C2+USB-A1/A2: 45.0W+30.0W+18.0W (QC3.0)

USB-C1/C2+USB-A1+USB-A2: 65.0W+18.0W (NO QC3.0)

USB-C1+USB-C2+USB-A1+USB-A2: 45.0W+30.0W+18.0W (NO QC3.0)

Σύνολο: 100.0W MAX

Λειτουργία

Είδος	Απαιτήσεις
Θερμοκρασία λειτουργίας	0°C έως 35°C
Θερμοκρασία αποθήκευσης	-20°C έως 85°C
Σχετική υγρασία	20% έως 80%, χωρίς συμπύκνωση
Υγρασία αποθήκευσης	5% έως 95%, χωρίς συμπύκνωση
Υψόμετρο μακροχρόνιας χρήσης	Λιγότερα από 5.000 m
Υψόμετρο αποθήκευσης	Λιγότερα από 15.000 m

ΣΗΜΑΝΤΙΚΕΣ ΟΔΗΓΙΕΣ ΓΙΑ ΤΗΝ ΑΛΛΑΓΗ ΤΩΝ ΑΝΤΑΛΛΑΞΙΜΩΝ ΒΥΣΜΑΤΩΝ AC

Διαδικασίες:

1. Πριν τη χρήση βεβαιωθείτε για την καταλληλότητα του ανταλλάξιμου βύσματος AC.

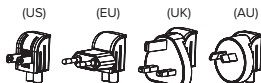

2. Όταν αλλάζετε το ανταλλάξιμο βύσμα AC (το βύσμα AC των ΗΠΑ απεικονίζεται ως παράδειγμα των διαδικασιών), σύρετε πρώτα τον άνω μοχλό προς τα εμπρός και απομακρύνετε το.

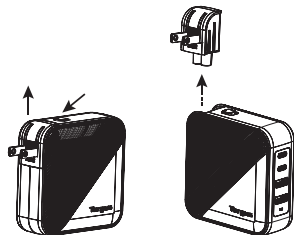

3. Σύρετε μέσα το κατάλληλο ανταλλάξιμο βύσμα AC για τη χώρα στην οποία βρίσκεστε.

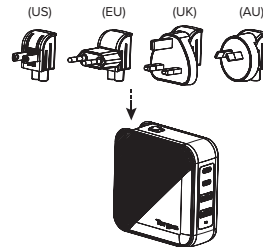

ΔΙΑΒΑΣΤΕ ΟΛΕΣ ΤΙΣ ΟΔΗΓΙΕΣ ΠΡΙΝ ΤΗ ΧΡΗΣΗ

ΣΗΜΑΝΤΙΚΕΣ ΟΔΗΓΙΕΣ ΑΣΦΑΛΕΙΑΣ

Προληπτικά μέτρα

1. Βεβαιώνετε πάντα ότι η ονομαστική τάση εισόδου του φορτιστή τοίχου είναι συμβατή με την έξοδο την οποία πρόκειται να χρησιμοποιήσετε.
2. Ο φορτιστής τοίχου πρέπει να έχει εισαχθεί πλήρως μέσα στην έξοδο. Ποτέ μη χρησιμοποιείτε τον φορτιστή τοίχου εάν η ακίδα ή το έλασμα είναι εκτεθειμένα.
3. Επιβεβαιώνετε ότι το ανταλλάξιμο βύσμα AC είναι κατάλληλο για τη χώρα στην οποία βρίσκεστε, πριν το συνδέσετε στην πρίζα.
4. Ποτέ μην αγγίζετε οποιοδήποτε μεταλλικό τμήμα του φορτιστή τοίχου κατά τη χρήση.
5. Το προϊόν έχει σχεδιαστεί μόνο για χρήση σε εσωτερικό χώρο.
6. Εάν η μεταλλική ακίδα των βυσμάτων AC παραμορφωθεί ή λασκάρει, σταματήστε τη χρήση.

Εάν και οι δύο θύρες USB-A είναι συνδεδεμένες, το χαρακτηριστικό QC3.0 θα απενεργοποιηθεί

Μονή θύρα εξόδου:

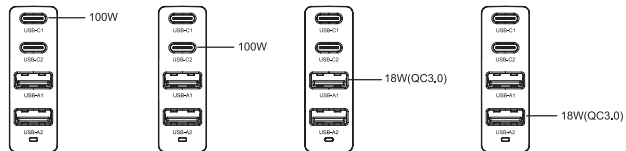

Διπλές θύρες εξόδου:

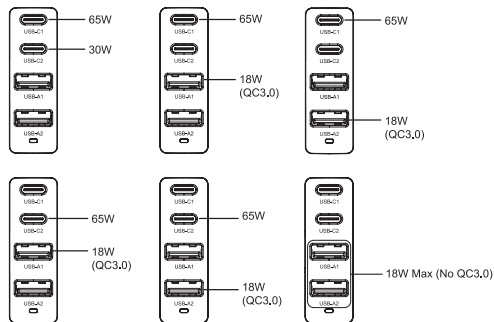

Τριπλές θύρες εξόδου:

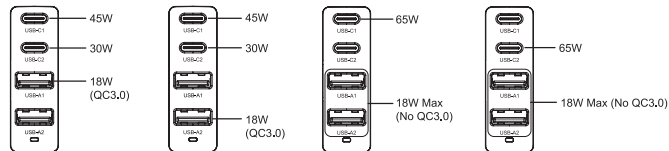

Όλες οι θύρες εξόδου:

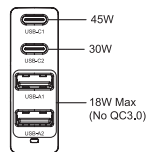

Πληροφορίες εξωτερικής τροφοδοσίας ισχύος

Κατασκευαστής	Targus International LLC
Διεύθυνση	1211 North Miller Street, Anaheim, CA 92806 ΗΠΑ
Εμπορικός αριθμών καταχώρισης	5892659
Μοντ./Αδεια	APA109
Τάση εισόδου	100-240V~
Συχνότητα AC εισόδου	50/60Hz
Τάση εξόδου	Μονή θύρα: USB-C1/C2 PD: 5.0V/9.0V/12.0V/15.0V = 3.0A, 20.0V = 5.0A USB-C1/C2: PPS 3.30-21.0V = 5.0A 100.0W MAX USB-A1/A2 QC3.0: 5.0V = 3.0A, 9.0V = 2.0A, 12.0V = 1.5A, 18.0W MAX
Ρεύμα εξόδου	Πολλαπλή θύρα: USB-C1+USB-C2: 65.0W+30.0W USB-C1+USB-C2+USB-A1/A2: 45.0W+30.0W+18.0W (QC3.0) USB-C1/USB-C2+USB-A1+USB-A2: 65.0W+18.0W (NO QC3.0) USB-C1+USB-C2+USB-A1+USB-A2: 45.0W+30.0W+18.0W (NO QC3.0)
Ισχύς εξόδου	100.0W MAX

Μέση ενεργή απόδοση	Πολλαπλή θύρα: USB-C1+USB-C2+USB-A1+USB-A2: (5.0V = 3.0A+5.0V = 3.0A+5.0V = 1.8A+5.0V = 1.8A):87.38% USB-C1+USB-C2+USB-A1: (20.0V = 2.25A+20.0V = 1.5A+12.0V = 1.5A):88.92% Μονή θύρα: USB-C1: 20.0V = 5.0A:90.16% USB-C1: 21.0V = 4.76A:90.33%
Απόδοση σε χαμηλό φορτίο (10%)	Πολλαπλή θύρα: USB-C1+USB-C2+USB-A1+USB-A2: (5.0V = 3.0A+5.0V = 3.0A+5.0V = 1.8A+5.0V = 1.8A):84.30% USB-C1+USB-C2+USB-A1: (20.0V = 2.25A+20.0V = 1.5A+12.0V = 1.5A):81.36% Μονή θύρα: USB-C1: 20.0V = 5.0A:80.82% USB-C1: 21.0V = 4.76A:85.28%
Κατανάλωση ισχύος χωρίς φορτίο	0.094W

Οι ανωτέρω πληροφορίες βρίσκονται στον ιστότοπο του εισαγωγέα www.targus.com

IT Introduzione

Questo caricabatteria a parete è dotato della tecnologia GaN e spine intercambiabili per l'uso internazionale, e permette di ricaricare simultaneamente più dispositivi con presa USB come computer portatili, tablet e smartphone di diversi marchi (Apple, Dell, Google, Lenovo, Samsung e altri).

Contenuto

- Adattatore da viaggio GaN 100 W di Targus
- Spine US, EU, UK, AU
- Manuale di istruzioni

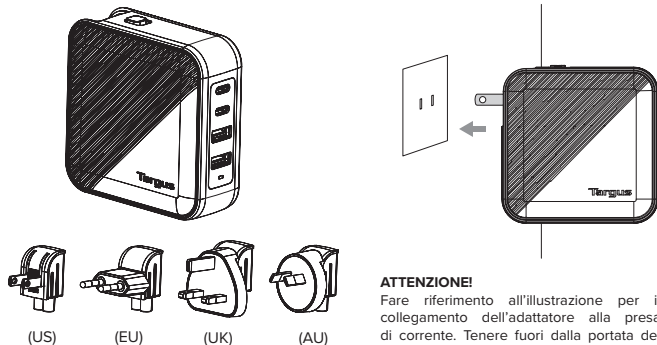

ATTENZIONE!

Fare riferimento all'illustrazione per il collegamento dell'adattatore alla presa di corrente. Tenere fuori dalla portata dei bambini.

Dati elettrici

Ingresso: 100 - 240VAC 1.8A MAX 50/60Hz

Uscita:

Presa singola:

USB-C1/C2 PD: 5.0V/9.0V/12.0V/15.0V = 3.0A, 20.0V = 5.0A

USB-C1/C2: PPS 3.30-21.0V = 5.0A 100.0W MAX

USB-A1/A2 QC3.0: 5.0V = 3.0A, 9.0V = 2.0A, 12.0V = 1.5A, 18.0W MAX

Presa multipla:

USB-C1+USB-C2: 65.0W+30.0W

USB-C1+USB-C2+USB-A1/A2: 45.0W+30.0W+18.0W (QC3.0)

USB-C1/C2+USB-A1+USB-A2: 65.0W+18.0W (NO QC3.0)

USB-C1+USB-C2+USB-A1+USB-A2: 45.0W+30.0W+18.0W (NO QC3.0)

Totale: 100,0 W MAX

Utilizzo

Temperatura di funzionamento	Requisiti
Temperatura di conservazione	Da 0°C a 35°C
Umidità di funzionamento	Da -20°C a 85°C
Umidità di conservazione	Dal 20% al 80%, senza condensa
Altitudine di funzionamento	Dal 5% al 95%, senza condensa
Altitudine di conservazione	Inferiore a 5000 m
Storage altitude	Inferiore a 15000 m

ISTRUZIONI IMPORTANTI PER LA SOSTITUZIONE DELLE SPINE INTERCAMBIABILI

Procedura

1. Assicurarsi che la spina sia corretta prima dell'uso.

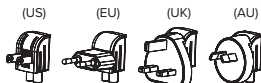

2. Per sostituire la spina intercambiabile (in figura è illustrata la spina US come esempio), fare scorrere la leva superiore in avanti e rimuovere la spina.

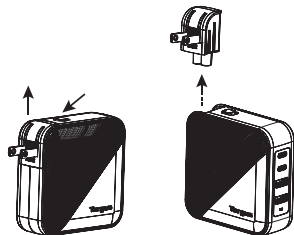

3. Inserire la spina intercambiabile corretta in base al Paese.

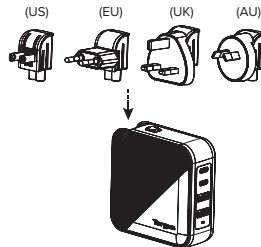

LEGGERE TUTTE LE ISTRUZIONI PRIMA DELL'USO.

ISTRUZIONI DI SICUREZZA IMPORTANTI

Precauzioni di sicurezza

1. Verificare sempre che la tensione in ingresso nominale del caricabatteria sia compatibile con la presa di corrente.
2. Inserire la spina del caricabatteria completamente nella presa di corrente. Non usare il caricabatteria se i poli o le lamelle sono esposte.
3. Prima di collegare il caricabatteria alla presa di corrente, assicurarsi che la spina intercambiabile sia adatta al Paese.
4. Non toccare alcuna parte metallica del caricabatteria quando è in uso.
5. Questo prodotto è progettato per il solo uso in interni.
6. Non usare la spina se i poli metallici sono deformati o allentati.

Se entrambe le prese USB-A sono in uso, la funzione QC 3.0 sarà disattivata.

Uscita presa singola

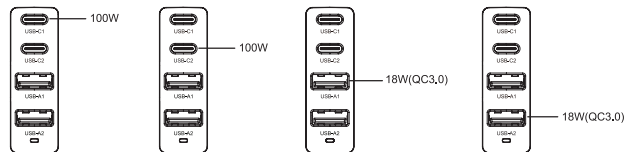

Uscita presa doppia

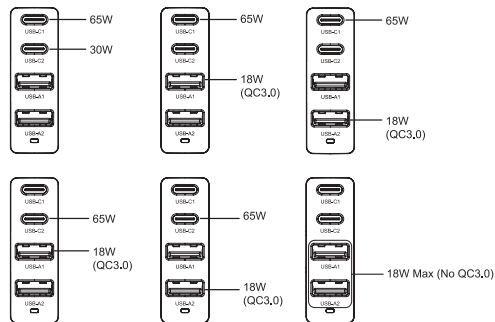

Uscita presa tripla

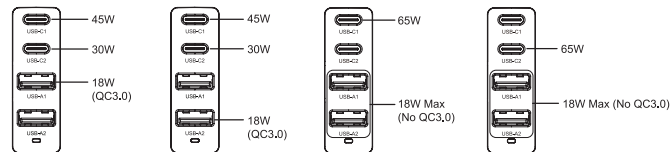

Uscita tutte le prese

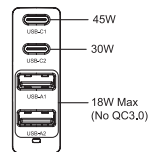

Informazioni sull'unità di alimentazione esterna

Fabbricante	Targus International LLC
Sede	1211 North Miller Street, Anaheim, CA 92806 USA
Numero di iscrizione nel registro delle imprese	5892659
Modello/Reg	APA109
Tensione in ingresso	100-240 V [~]
Frequenza CA in ingresso	50/60 Hz
Tensione in uscita	Presenza singola: USB-C1/C2 PD: 5,0 V / 9,0 V / 12,0 V / 15,0 V = 3,0 A, 20,0 V = 5,0 A USB-C1/C2: PPS 3,30-21,0 V = 5,0 A 100,0 W MAX USB-A1/A2 QC 3.0: 5,0 V = 3,0 A, 9,0 V = 2,0 A, 12,0 V = 1,5 A, 18,0 W MAX
Corrente in uscita	Presenza multipla: USB-C1+USB-C2: 65,0 W + 30,0 W USB-C1+USB-C2+USB-A1/A2: 45,0 W + 30,0 W + 18,0 W (QC 3.0) USB-C1/USB-C2+USB-A1+USB-A2: 65,0 W + 18,0 W (NO QC3.0) USB-C1+USB-C2+USB-A1+USB-A2: 45,0 W + 30,0 W + 18,0 W (NO QC 3.0)
Potenza in uscita	100.0W MAX

Rendimento medio in modo attivo	Presenza multipla: USB-C1+USB-C2+USB-A1+USB-A2: (5,0 V = 3,0 A + 5,0 V = 3,0 A + 5,0 V = 1,8 A + 5,0 V = 1,8 A): 87,38% USB-C1+USB-C2+USB-A1: (20,0 V = 2,25 A + 20,0 V = 1,5 A + 12,0 V = 1,5 A): 88,92% Presenza singola: USB-C1: 20,0 V = 5,0 A: 90,16% USB-C1: 21,0 V = 4,76 A: 90,33%
Efficienza a basso carico (10%)	Presenza multipla: USB-C1+USB-C2+USB-A1+USB-A2: (5,0 V = 3,0 A + 5,0 V = 3,0 A + 5,0 V = 1,8 A + 5,0 V = 1,8 A): 84,30% USB-C1+USB-C2+USB-A1: (20,0 V = 2,25 A + 20,0 V = 1,5 A + 12,0 V = 1,5 A): 81,36% Presenza singola: USB-C1: 20,0 V = 5,0 A: 80,82% USB-C1: 21,0 V = 4,76 A: 85,28%
Consumo elettrico a vuoto	0.094W

Le informazioni sopra riportate possono essere consultate sul sito web dell'importatore www.targus.com

ITALIAN

Targus

Dichiarazione di conformità



Fabbricante:	Targus International LLC	Tel.:	1-714-765-5555
Indirizzo:	1211 North Miller Street, Anaheim, CA 92806 USA	Fax:	1-714-765-5599
Importatore:	Targus Europe Ltd.	Internet:	www.targus.com
Indirizzo:	Targus EMEA Account Management, Van Hilstraat 19, 5145 RK Waalwijk, NETHERLANDS	Tel.:	+44 (0)20 8831 2000

Con la presente confermiamo che il seguente prodotto denominato GaN AC Travel Adapter, Modello N. APA102 Nome del marchio "TARGUS", è conforme a Low Voltage Directive 2014/35/EU, Commission Regulation (EU) 2019/1782, della ErP Directive 2009/125/EC, EMC Directive 2014/30/EU, EU ROHS Directive 2011/65/EU and its amendment Directive (EU) 2015/863.

Per la valutazione relativa alle Direttive indicate sopra, sono stati applicati i seguenti standard:

Low-Voltage Directive: 2014/35/EU
EN IEC 62368-1:2020+A11:2020

EMC Directive: 2014/30/EU
EN 55032:2015+A1:2020
EN IEC 61000-3-2:2019+A1:2021
EN 61000-3-3:2013+A2:2021
EN 55035:2017+A11:2020

Erp Directive : COMMISSION REGULATION (EU) 2019/1782

RoHS Directive: 2011/65/EU and its amendment Directive (EU) 2015/863
EN IEC 63000:2018

Anno di inizio della marcatura CE: 2022

Direttore, Targus - Global Sourcing Group	CF Ngoh
Funzione / Titolo	Nome
7/28/2022 / Hong Kong	
Data / Luogo di emissione	Softscritto in nome e per conto di Targus

NL Inleiding

Deze wandlader met GaN-technologie en verwisselbare stekkers voor internationaal gebruik maakt het gelijktijdig opladen van meerdere apparaten, zoals laptops, tablets, smartphones en andere USB-aangedreven apparaten van verschillende fabrikant, waaronder Apple, Dell, Google, Lenovo en Samsung, mogelijk.

Inhoud

- Targus 100W GaN AC reisadapter
- US, EU, UK, AU - AC-stekker
- Gebruiksaanwijzing

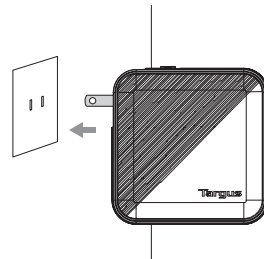
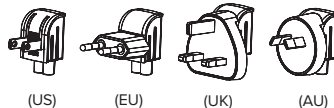
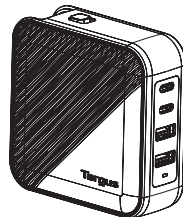
**OPGELET:**

Raadpleeg de afbeelding voor aansluiting op het stopcontact. Buiten het bereik van kinderen houden.

Elektrisch vermogen:

Ingang: 100 - 240VAC 1.8A MAX 50/60Hz

Uitgang:

Eén poort:

USB-C1/C2 PD: 5.0V/9.0V/12.0V/15.0V = 3.0A, 20.0V = 5.0A

USB-C1/C2: PPS 3.30-21.0V = 5.0A 100.0W MAX

USB-A1/A2 QC3.0: 5.0V = 3.0A, 9.0V = 2.0A, 12.0V = 1.5A, 18.0W MAX

Meerdere poorten:

USB-C1+USB-C2: 65.0W+30.0W

USB-C1+USB-C2+USB-A1/A2: 45.0W+30.0W+18.0W (QC3.0)

USB-C1/C2+USB-A1+USB-A2: 65.0W+18.0W (NO QC3.0)

USB-C1+USB-C2+USB-A1+USB-A2: 45.0W+30.0W+18.0W (NO QC3.0)

Totaal: 100,0 W MAX

Werking

Item	Vereisten
Werkings temperatuur	0°C tot 35°C
Opslagtemperatuur	-20°C tot 85°C
Relatieve vochtigheid	20% tot 80%, niet-condenserend
Opslagvochtigheid	5% tot 95%, niet-condenserend
Lange termijn-hoogte	Minder dan 5000m
Opslaghoogte	Minder dan 15000m

BELANGRIJKE INSTRUCTIES VOOR HET VERVANGEN VAN DE VERWISSELBARE AC-STEKKERS**Procedure:**

1. Bevestig of het de gepaste verwisselbare AC-stekker is vóór gebruik.

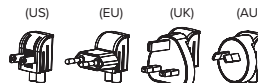

2. Voor het vervangen van de verwisselbare AC-stekker (US AC-stekker als voorbeeld ter illustratie van de procedure), schuif de bovenste hendel eerst vooruit en verwijder de stekker.

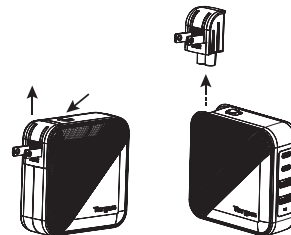

3. Schuif de gepaste verwisselbare AC-stekker, voor het land waar u zich in bevindt, in.

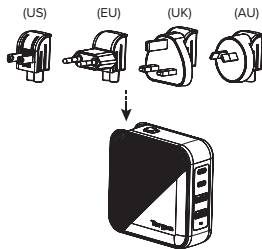

LEES ALLE INSTRUCTIES VOOR GEBRUIK

BELANGRIJKE VEILIGHEIDSLINSTRUCTIES

Voorzorgsmaatregelen

1. Zorg dat de nominale ingangsspanning van de wandlader compatibel is met het stopcontact dat u van plan bent te gebruiken.
2. De wandlader moet volledig in het stopcontact worden aangebracht. Gebruik de wandlader nooit als de pen of blad blootgesteld is.
3. Bevestig of de verwisselbare AC-stekker gepast is voor het land waar u zich in bevindt voordat de stekker in het stopcontact wordt gestoken.
4. Raak geen enkel metaal deel van de wandlader aan wanneer in gebruik.
5. Het product is alleen ontworpen voor gebruik binnenshuis.
6. Als de metalen pin van de AC-stekker vervormd raakt of los zit, gebruik de stekker niet langer.

Als beide USB-A-poorten aangesloten zijn, is de QC3.0-functie uitgeschakeld

Uitvoer één poort:

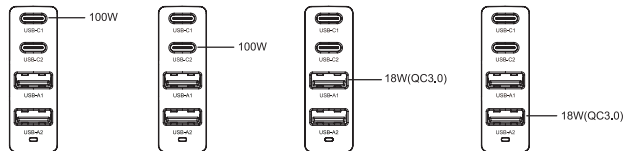

Uitvoer twee poorten:

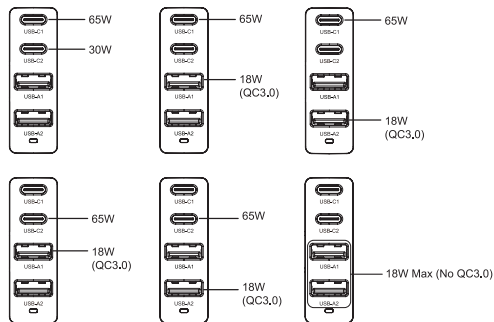

Uitvoer drie poorten:

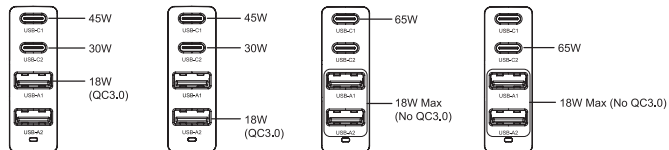

Uitvoer alle poorten:

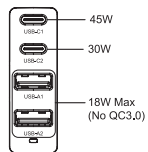

Informatie externe voeding

Fabrikant	Targus International LLC
Adres	1211 North Miller Street, Anaheim, CA 92806 VSA
Handels-register-nummer	5892659
Model/Reg	APA109
Ingangsspanning	100-240V~
AC-ingangsfrequentie	50/60Hz
Uitgangsspanning	Eén poort: USB-C1/C2 PD: 5,0V/9,0V/12,0V/15,0V = 3,0A, 20,0V = 5,0A USB-C1/C2: PPS 3,30-21,0V = 5,0A 100,0W MAX USB-A1/A2 QC3.0: 5,0V = 3,0A, 9,0V = 2,0A, 12,0V = 1,5A, 18,0W MAX
Uitgangsstroom	Meerdere poorten: USB-C1+USB-C2: 65,0W+30,0W USB-C1+USB-C2+USB-A1/A2: 45,0W+30,0W+18,0W (QC3.0) USB-C1/USB-C2+USB-A1+USB-A2: 65,0W+18,0W (NO QC3.0) USB-C1+USB-C2+USB-A1+USB-A2: 45,0W+30,0W+18,0W (NO QC3.0)
Uitgangsvermogen	100,0W MAX

Gemiddelde actieve efficiëntie	<p>Meerdere poorten: USB-C1+USB-C2+USB-A1+USB-A2: (5,0V = 3,0A+5,0V = 3,0A+5,0V = 1,8A+5,0V = 1,8A): 87,38%</p> <p>USB-C1+USB-C2+USB-A1: (20,0V = 2,25A+20,0V = 1,5A+12,0V = 1,5A): 88,92%</p> <p>Eén poort: USB-C1: 20,0V = 5,0A: 90,16% USB-C1: 21,0V = 4,76A: 90,33%</p>
Efficiëntie bij lage belasting (10 %)	<p>Meerdere poorten: USB-C1+USB-C2+USB-A1+USB-A2: (5,0V = 3,0A+5,0V = 3,0A+5,0V = 1,8A+5,0V = 1,8A): 84,30%</p> <p>USB-C1+USB-C2+USB-A1: (20,0V = 2,25A+20,0V = 1,5A+12,0V = 1,5A): 81,36%</p> <p>Eén poort: USB-C1: 20,0V = 5,0A: 80,82% USB-C1: 21,0V = 4,76A: 85,28%</p>
Nullastverbruik	0.094W

Bovenstaande informatie kan worden gevonden op de importeur website www.targus.com

Dutch



Conformiteitsverklaring

Fabrikant:	Targus International LLC	Tel:	1-714-765-5555
Adres:	1211 North Miller Street, Anaheim, CA 92806 VS	Fax:	1-714-765-5599
Importeur:	Targus Europe Ltd.	Internet:	www.targus.com
Adres:	Targus EMEA Account Management, Van Hilststraat 19, 5145 RK Waalwijk, NETHERLANDS	Tel:	+44 (0)20 8831 2000

Hierbij bevestigen wij dat het volgende specifieke product GaN AC Travel Adapter, Modelnummer APA109 merknaam "TARGUS", voldoet aan de Low Voltage Directive 2014/35/EU, Commission Regulation (EU) 2019/1782 van ErP Directive 2009/125/EC, EMC Directive 2014/30/EU, EU ROHS Directive 2011/65/EU and its amendment Directive (EU) 2015/863.

Voor de evaluatie betreffende bovenstaande richtlijnen, zijn de volgende standaards toegepast:

Low-Voltage Directive: 2014/35/EU

EN IEC 62368-1:2020+A11:2020

EMC Directive: 2014/30/EU

EN 55032:2015+A1:2020

EN IEC 61000-3-2:2019+A1:2021

EN 61000-3-3:2013+A2:2021

EN 55035:2017+A11:2020

Erp Directive : COMMISSION REGULATION (EU) 2019/1782

RoHS Directive: 2011/65/EU and its amendment Directive (EU) 2015/863

EN IEC 63000:2018

Jaren tot begin E-markering: 2022

Directeur Targus, Global Sourcing Group

Functietitel

CF Ngoh

Naam

7/28/2022 , Hong Kong

Datum Uitgifteplaats



Getekend voor en namens Targus

NO Introduksjon

Denne vegggladeren med GaN-teknologi og utskiftbare plugger for internasjonal bruk muliggjør samtidig lading av flere enheter av bærbare datamaskiner, nettbrett, smarttelefoner og andre USB-drevne enheter fra utvalgte merker som Apple, Dell, Google, Lenovo, Samsung og flere.

Innhold

- Targus 100W GaN AC-reiseadapter
- USA, EU, UK, AU – AC-plugg
- Brukerhåndboken

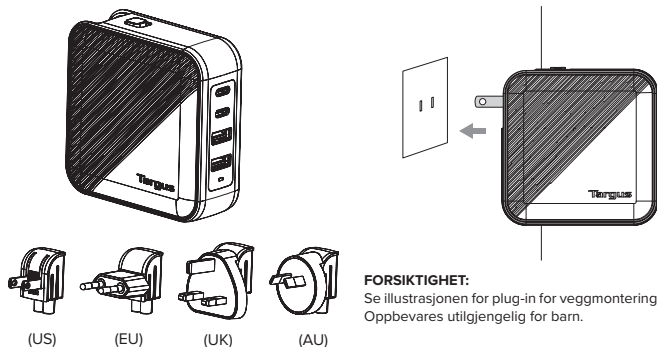
**Elektrisk vurdering**

Inngang: 100 - 240VAC 1.8A MAX 50/60Hz

Utgang:

Enkel port:

USB-C1/C2 PD: 5.0V/9.0V/12.0V/15.0V = 3.0A, 20.0V = 5.0A

USB-C1/C2: PPS 3.30-21.0V = 5.0A 100.0W MAX

USB-A1/A2 QC3.0: 5.0V = 3.0A, 9.0V = 2.0A, 12.0V = 1.5A, 18.0W MAX

Multiport:

USB-C1+USB-C2: 65.0W+30.0W

USB-C1+USB-C2+USB-A1/A2: 45.0W+30.0W+18.0W (QC3.0)

USB-C1/C2+USB-A1+USB-A2: 65.0W+18.0W (NO QC3.0)

USB-C1+USB-C2+USB-A1+USB-A2: 45.0W+30.0W+18.0W (NO QC3.0)

Totalt: 100,0 W MAKS

Operasjon

Punkt	Krav
Driftstemperatur	0°C til 35°C
Lager temperatur	-20°C til 85°C
Relativ fuktighet	20 % til 80 %, ikke-kondenserende
Oppbevaringsfuktighet	5 % til 95 %, ikke-kondenserende
Langsiktig høyde	Mindre enn 5000m
Lagringshøyde	Mindre enn 15000m

VIKTIGE INSTRUKSJONER FOR Å SKIFTE UT DE UTSKIFTBARE AC-PLUGGENE

Prosedyrer:

1. Bekreft den riktige utskiftbare AC-pluggen for bruk.

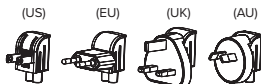

2. Når du skifter ut den utskiftbare AC-pluggen (USA AC-plugg som et eksempel for å illustrere prosedyrene), skyv toppspaken først fremover og fjern den.

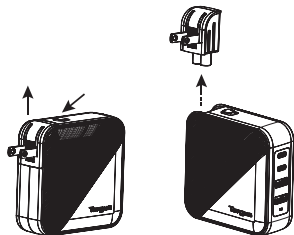

3. Før inn den riktige utskiftbare AC-pluggen for landet du er i.

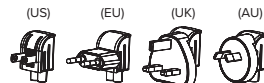

LES ALLE INSTRUKSJONER FØR BRUK

VIKTIGE SIKKERHETSINSTRUKSJONER

Forsiktighetsregler

1. Sørg alltid for at den nominelle inngangsspenningen til vegggladeren er kompatibel med stikkontakten du har tenkt å bruke.
2. Vegggladeren må være fullstendig satt inn i stikkontakten. Bruk aldri vegggladeren hvis stiftene eller bladet er synlig.
3. Bekreft at den utskiftbare AC-pluggen er riktig for landet du er i, før du kobler til stikkontakten.
4. Berør aldri noen metalldel av vegggladeren når den er i bruk.
5. Produktet er kun laget for innendørs bruk.
6. Hvis metallstiftene på AC-pluggene blir deformert eller er løs, må du slutte å bruke den.

Hvis begge USB-A-portene er tilkoblet, vil QC3.0-funksjonen bli deaktivert

Enkel utgangsport:

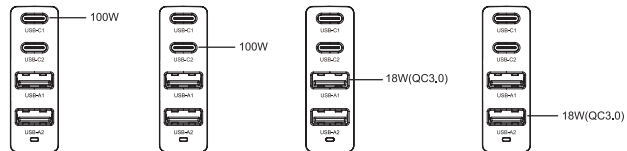

Utgang doble porter:

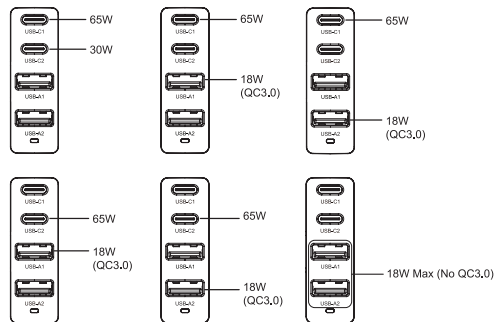

Utgang tre porter:

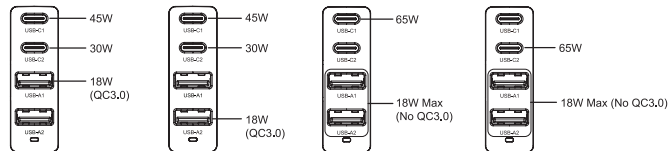

Utgang alle porter:

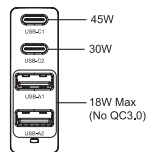

Informasjon om ekstern strømforsyning

Produsent	Targus International LLC
Adresse	1211 North Miller Street, Anaheim, CA 92806 USA
Kommersiell Registreringsnummer	5892659
Modell/Reg	APA109
Inngangsspenning	100-240V~
Input AC frekvens	50/60 Hz
Utgangsspenning	Enkel port: USB-C1/C2 PD: 5,0V/9,0V/12,0V/15,0V == 3,0A, 20,0V == 5,0A USB-C1/C2: PPS 3,30-21,0V == 5,0A 100,0W MAKS USB-A1/A2 QC3.0: 5,0V == 3,0A, 9,0V == 2,0A, 12,0V == 1,5A, 18,0W MAX
Utgangsstrøm	Multiport: USB-C1+USB-C2: 65,0 W+30,0 W USB-C1+USB-C2+USB-A1/A2: 45,0 W+30,0 W+18,0 W (QC3.0) USB-C1/USB-C2+USB-A1+USB-A2: 65,0 W+18,0 W (INGEN QC3.0) USB-C1+USB-C2+USB-A1+USB-A2: 45,0W+30,0W+18,0W (INGEN QC3.0)
Utgangseffekt	100,0 W MAKS

Gjennomsnittlig aktiv effektivitet	Multiport: USB-C1+USB-C2+USB-A1+USB-A2: (5,0V == 3,0A+5,0V == 3,0A+5,0V == 1,8A+5,0V == 1,8A):87,38 % USB-C1+USB-C2+USB-A1: (20,0V == 2,25A+20,0V == 1,5A+12,0V == 1,5A):88,92 % Enkel port: USB-C1: 20,0V == 5,0A:90,16 % USB-C1: 21,0V == 4,76A:90,33 %
Effektivitet ved lav belastning (10 %)	Multiport: USB-C1+USB-C2+USB-A1+USB-A2: (5,0V == 3,0A+5,0V == 3,0A+5,0V == 1,8A+5,0V == 1,8A):84,30 % USB-C1+USB-C2+USB-A1: (20,0V == 2,25A+20,0V == 1,5A+12,0V == 1,5A):81,36 % Enkel port: USB-C1: 20,0 V == 5,0 A: 80,82 % USB-C1: 21,0V == 4,76A:85,28 %
Strømforbruk uten belastning	0.094W

Informasjonen ovenfor kan finnes på importørens nettsted www.targus.com

PL Wstęp

Ta ładowarka ścienna z technologią GaN i wymiennymi wtyczkami do użytku międzynarodowego umożliwia jednocześnie ładowanie laptopów, tabletów, smartfonów i innych urządzeń zasilanych przez USB producentów różnych marek, w tym m.in. Apple, Dell, Google, Lenovo i Samsung.

Zawartość

- Podróżny zasilacz sieciowy Targus 100 W GaN
- Wtyczka sieciowa w standardzie US, EU, UK, AU
- Instrukcja obsługi

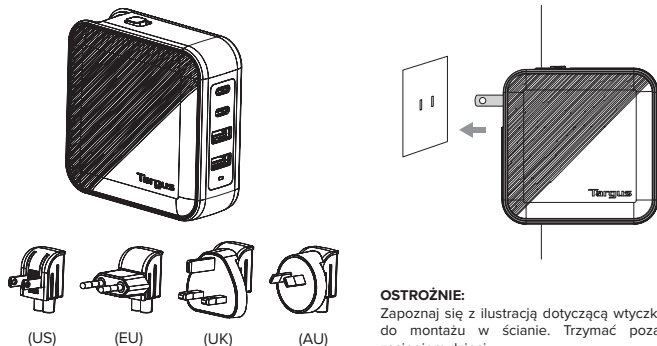
**OSTROŻNIE:**

Zapoznaj się z ilustracją dotyczącą wtyczki do montażu w ścianie. Trzymać poza zasięgiem dzieci.

Parametry elektryczne

Wejście: 100 - 240VAC 1.8A MAX 50/60Hz

Wyjście:

Port pojedynczy:

USB-C1/C2 PD: 5.0V/9.0V/12.0V/15.0V = 3.0A, 20.0V = 5.0A

USB-C1/C2: PPS 3.30-21.0V = 5.0A 100.0W MAX

USB-A1/A2 QC3.0: 5.0V = 3.0A, 9.0V = 2.0A, 12.0V = 1.5A, 18.0W MAX

Port wielokrotny:

USB-C1+USB-C2: 65.0W+30.0W

USB-C1+USB-C2+USB-A1/A2: 45.0W+30.0W+18.0W (QC3.0)

USB-C1/C2+USB-A1+USB-A2: 65.0W+18.0W (NO QC3.0)

USB-C1+USB-C2+USB-A1+USB-A2: 45.0W+30.0W+18.0W (NO QC3.0)

Razem: MAKS. 100,0 W

Działanie

Parametr	Wymagania
Temperatura pracy	od 0° do 35°C
Temperatura przechowywania	od -20° do 85°C
Wilgotność względna	20-80%, bez kondensacji
Wilgotność przechowywania	5%-95%, bez kondensacji
Wysokość długoterminowa	Poniżej 5000 m
Wysokość przechowywania	Poniżej 15 000 m

WAŻNE INSTRUKCJE DOTYCZĄCE WYMIANY ZAMIENNYCH WTYCZEK SIECIOWYCH

Procedury:

1. Przed użyciem należy potwierdzić, że wymienna wtyczka sieciowa jest odpowiednia.

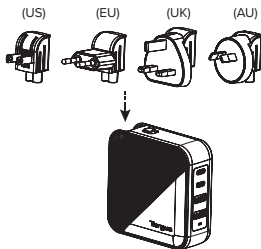

2. Podczas wymiany wymiennej wtyczki sieciowej (wtyczka sieciowa US jest tylko przykładem ilustrującym procedury) należy najpierw przesunąć górną dźwignię do przodu, a potem wyjąć wtyczkę.

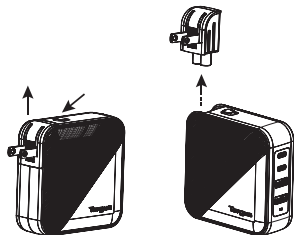

3. Wsunąć wymienną wtyczkę sieciową odpowiednią do używania w danym kraju.

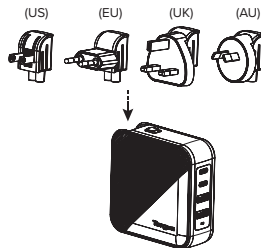

PRZED UŻYCIEM NALEŻY PRZECZYTAĆ WSZYSTKIE INSTRUKCJE WAŻNE INSTRUKCJE DOTYCZĄCE BEZPIECZEŃSTWA

Zasady bezpieczeństwa

1. Należy zawsze pilnować, aby napięcie znamionowe na wejściu ładowarki ściennej było odpowiednie dla wyjścia, które ma być używane.
2. Ładowarka ścienna musi być całkowicie włożona do kontaktu. Nigdy nie należy używać ładowarki ściennej jeśli bolec lub wtyk płaski jest odsłonięty.
3. Przed włożeniem do kontaktu należy potwierdzić, że wymienną wtyczka sieciowa jest odpowiednia do stosowania w kraju, w którym przebywa użytkownik.
4. Nigdy nie należy dotykać jakichkolwiek części metalowych ładowarki ściennej w czasie jej używania.
5. Produkt został zaprojektowany wyłącznie do użytku w pomieszczeniach.
6. Jeśli metalowy bolec wtyczki sieciowej odkształci się lub poluzuje, należy zaprzestać używania wtyczki.

Jeśli oba porty USB-A są podłączone, funkcja QC3.0 zostanie wyłączona

Wyjście pojedynczy port:

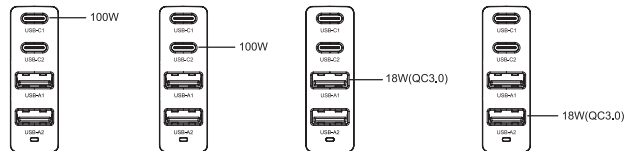

Wyjście podwójny port:

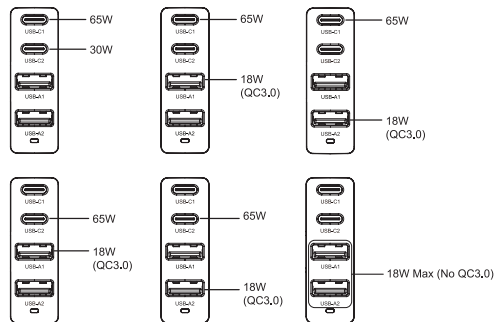

Wyjście potrójny port:

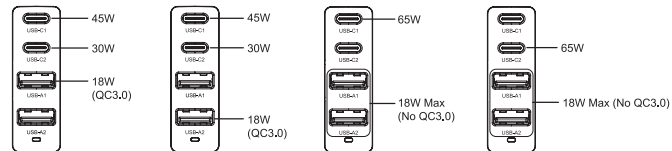

Wyjście wszystkich portów:

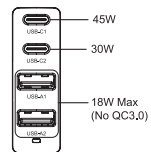

Informacje o ładowarce podróżnej

Producent	Targus International LLC
Adres	1211 North Miller Street, Anaheim, CA 92806 USA
Dystrybutor Numer rejestracyjny produktu	5892659
Model	APA109
Napięcie wejściowe	100-240 V [~]
Częstotliwość wejściowa prądu przemiennego	50/60 Hz
Napięcie wyjściowe	Pojedynczy port: USB-C1/C2 PD: 5,0 V/9,0 V/12,0 V/15,0 V = 3,0 A, 20,0 V = 5,0 A USB-C1/C2: PPS 3,30-21,0 V = 5,0 A 100,0 W MAKS. USB-A1/A2 QC3.0: 5,0 V = 3,0 A, 9,0 V = 2,0 A, 12,0 V = 1,5 A, 18,0 W MAKS.
Prąd wyjściowy	Wieloportowa: USB-C1+USB-C2: 65,0 W+30,0 W USB-C1+USB-C2+USB-A1/A2: 45,0 W+30,0 W+18,0 W (QC3.0) USB-C1/USB-C2+USB-A1+USB-A2: 65,0 W+18,0 W (NO QC3.0) USB-C1+USB-C2+USB-A1+USB-A2: 45,0 W+30,0 W+18,0 W (NO QC3.0)
Moc wyjściowa	MAKS. 100,0 W

Średnia moc czynna	Wieloportowa: USB-C1+USB-C2+USB-A1+USB-A2: (5.0V = 3.0A+5.0V = 3.0A+5.0V = 1.8A+5.0V = 1.8A):87.38% USB-C1+USB-C2+USB-A1: (20.0V = 2.25A+20.0V = 1.5A+12.0V = 1.5A):88.92% Pojedynczy port: USB-C1: 20.0V = 5.0A:90.16% USB-C1: 21.0V = 4.76A:90.33%
Sprawność przy niskim obciążeniu (10%)	Wieloportowa: USB-C1+USB-C2+USB-A1+USB-A2: (5,0 V = 3,0 A+5,0 V = 3,0 A+5,0 V = 1,8 A+5,0 V = 1,8 A): 84,30% USB-C1+USB-C2+USB-A1: (20.0V = 2.25A+20.0V = 1.5A+12.0V = 1.5A):81.36% Pojedynczy port: USB-C1: 20,0 V = 5,0 A: 80,82% USB-C1: 21,0 V = 4,76 A:85,28%
Pobór mocy bez obciążenia	0.094W

Powyższe informacje można znaleźć na stronie importera www.targus.com

PT Introdução

Este carregador de parede com a tecnologia GaN e fichas permutáveis para uma utilização internacional permite carregar vários dispositivos em simultâneo, como computadores portáteis, tablets, Smartphones e outros dispositivos USB de várias marcas, incluindo Apple, Dell, Google, Lenovo, Samsung e outras.

Conteúdo

- Adaptador de viagem AC GaN de 100W da Targus
- US, EU, UK, AU - Ficha AC
- Guia do utilizador

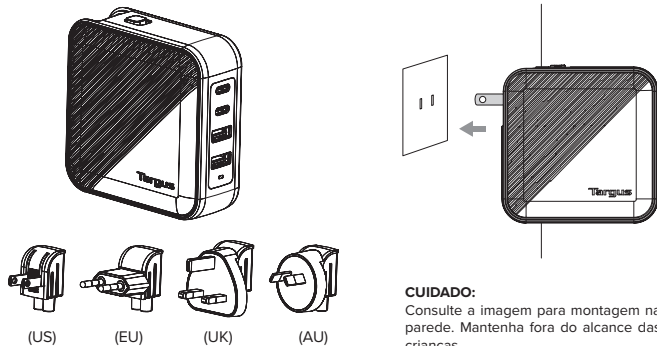
**Classificação elétrica**

Entrada: 100 - 240VAC 1.8A MAX 50/60Hz

Saída:

Porta simples:

USB-C1/C2 PD: 5.0V/9.0V/12.0V/15.0V = 3.0A, 20.0V = 5.0A

USB-C1/C2: PPS 3.30-21.0V = 5.0A 100.0W MAX

USB-A1/A2 QC3.0: 5.0V = 3.0A, 9.0V = 2.0A, 12.0V = 1.5A, 18.0W MAX

Multi porta:

USB-C1+USB-C2: 65.0W+30.0W

USB-C1+USB-C2+USB-A1/A2: 45.0W+30.0W+18.0W (QC3.0)

USB-C1/C2+USB-A1+USB-A2: 65.0W+18.0W (NO QC3.0)

USB-C1+USB-C2+USB-A1+USB-A2: 45.0W+30.0W+18.0W (NO QC3.0)

Total: 100,0W MÁX

Funcionamento

Artigo	Requisitos
Temperatura de funcionamento	0 °C a 35 °C
Temperatura de armazenamento	-20 °C a 85 °C
Humidade relativa	20% a 80% sem condensação
Humidade de armazenamento	5% a 95% sem condensação
Altitude prolongada	Menos de 5000 m
Altitude de armazenamento	Menos de 15 000 m

INSTRUÇÕES IMPORTANTES PARA A MUDANÇA DAS FICHAS AC PERMUTÁVEIS

Procedimento:

1. Certifique-se de a ficha AC permutável adequada antes da utilização.

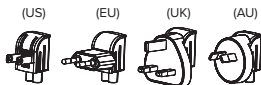

2. Quando substituir a ficha AC permutável (ficha AC US como exemplo para ilustrar os procedimentos), faça deslizar a alavanca superior para a frente e depois retire-a.

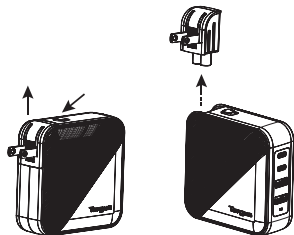

3. Faça deslizar a ficha AC permutável adequada para o país em que se encontra.

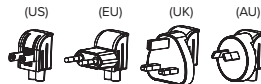

LEIA TODAS AS INSTRUÇÕES ANTES DA UTILIZAÇÃO.

INSTRUÇÕES DE SEGURANÇA IMPORTANTES

Precauções de segurança

1. Certifique-se sempre de que a voltagem de entrada nominal do carregador de parede é compatível com a tomada que pretende usar.
2. O carregador de parede tem de ser completamente inserido na tomada. Nunca use o carregador de parede se o dente ou lâmina estiverem expostos.
3. Certifique-se de que a ficha AC permutável é adequada para o país onde se encontra antes de a ligar à tomada.
4. Nunca toque em nenhuma parte do carregador de parede durante a utilização.
5. O produto foi criado apenas para uma utilização no interior.
6. Se o dente de metal da ficha AC ficar deformado ou solto, pare de usar o aparelho.

Se ambas as portas **USB-A** estiverem ligadas, a funcionalidade **QC3.0** será desativada.

Porta de saída simples:

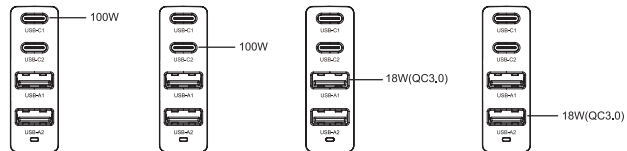

Porta de saída dupla:

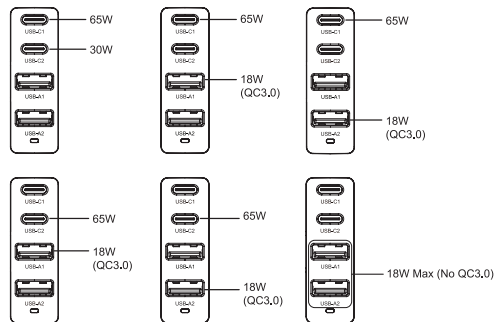

Porta de saída tripla:

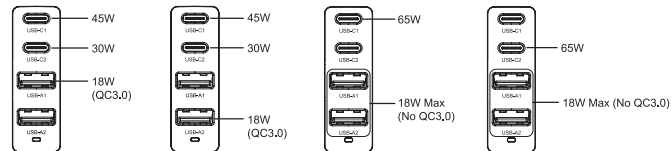

Todas as portas de saída:

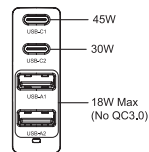

Informação sobre a alimentação externa

Fabricante	Targus International LLC
Morada	1211 North Miller Street, Anaheim, CA 92806 USA
Comercial Número de registo	5892659
Modelo/Reg	APA109
Voltagem de entrada	100-240V~
Frequência de entrada AC	50/60Hz
Voltagem de saída	Porta simples: USB-C1/C2 PD: 5,0V/9,0V/12,0V/15,0V = 3,0A, 20,0V = 5,0A USB-C1/C2: PPS 3.30-21,0V = 5,0A 100,0W MÁX USB-A1/A2 QC3.0: 5,0V = 3,0A, 9,0V = 2,0A, 12,0V = 1,5A, 18,0W MÁX
Corrente de saída	Multi porta: USB-C1+USB-C2: 65,0W+30,0W USB-C1+USB-C2+USB-A1/A2: 45,0W+30,0W+18,0W (QC3.0) USB-C1/USB-C2+USB-A1+USB-A2: 65,0W+18,0W (SEM QC3.0) USB-C1+USB-C2+USB-A1+USB-A2: 45,0W+30,0W+18,0W (SEM QC3.0)
Potência de saída	100,0W MÁX

Eficiência ativa média	Multi porta: USB-C1+USB-C2+USB-A1+USB-A2: (5,0V = 3,0A+5,0V = 3,0A+5,0V = 1,8A+5,0V = 1,8A): 87,38% USB-C1+USB-C2+USB-A1: (20,0V = 2,25A+20,0V = 1,5A+12,0V = 1,5A): 88,92% Porta simples: USB-C1: 20,0V = 5,0A: 90,16% USB-C1: 21,0V = 4,76A: 90,33%
Eficiência com pouca carga (10%)	Multi porta: USB-C1+USB-C2+USB-A1+USB-A2: (5,0V = 3,0A+5,0V = 3,0A+5,0V = 1,8A+5,0V = 1,8A): 84,30% USB-C1+USB-C2+USB-A1: (20,0V = 2,25A+20,0V = 1,5A+12,0V = 1,5A): 81,36% Porta simples: USB-C1: 20,0V = 5,0A: 80,82% USB-C1: 21,0V = 4,76A: 85,28%
Consumo de energia sem carga	0,094W

A informação apresentada acima pode ser encontrada no website do importador: www.targus.com

PORTUGUESE

Targus

Declaração de conformidade

Fabricante:	Targus International LLC	Tel:	1-714-765-5555
Morada:	1211 North Miller Street, Anaheim, CA 92806 USA	Fax:	1-714-765-5599
Importador:	Targus Europe Ltd.	Internet:	www.targus.com
Morada:	Targus EMEA Account Management, Van Hilststraat 19, 5145 RK Waalwijk, NETHERLANDS	Tel:	+44 (0)20 8831 2000

Vimos por este meio confirmar que o produto com a designação GaN AC Travel Adapter, n.º de modelo APA1024 da marca "TARGUS", está em conformidade com a Low Voltage Directive, 2014/35/EU, Commission Regulation (EU) 2019/1782 do ErP Directive 2009/125/EC, EMC Directive, 2014/30/EU, EU RoHS Directive 2011/65/EU and its amendment Directive (EU) 2015/863.

Na avaliação respeitante às Diretivas atrás referidas foram aplicadas as seguintes normas:

Low-Voltage Directive: 2014/35/EU
EN IEC 62368-1:2020+A11:2020

EMC Directive: 2014/30/EU
EN 55032:2015+A1:2020
EN IEC 61000-3-2:2019+A1:2021
EN 61000-3-3:2013+A2:2021
EN 55035:2017+A11:2020

Erp Directive : COMMISSION REGULATION (EU) 2019/1782
RoHS Directive: 2011/65/EU and its amendment Directive (EU) 2015/863
EN IEC 63000:2018

Ano de início da marcação CE: 2022

Administrador, Targus - Global Sourcing	CF Ngoh
Group	
Cargo	None

7/28/2022 / Hong Kong
Data / Local de emissão



Assinado em representação da Targus

RU Введение

Это сетевое зарядное устройство с технологией GaN и сменными вилками для международного использования позволяет одновременно заряжать несколько устройств: ноутбуки, планшеты, смартфоны и другие устройства с питанием от USB. Поддерживаются устройства таких производителей, как Apple, Dell, Google, Lenovo, Samsung и другие.

Комплект поставки

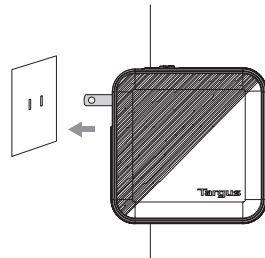
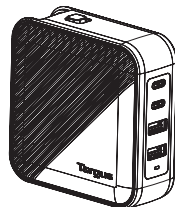
- Дорожный адаптер переменного тока Targus GaN 100 Вт
- Вилки переменного тока стандарта США, ЕС, Великобритании и Австралии.
- Руководство пользователя.



(US)

(EU)

(UK)

(AU)

ВНИМАНИЕ!

Для подключения к настенной розетке см. рисунок. Хранить в недоступном для детей месте.

Электрические характеристики

Вход: 100 - 240VAC 1,8A MAX 50/60Hz

Выход:

Один порт:

USB-C1/C2 PD: 5,0V/9,0V/12,0V/15,0V = 3,0A, 20,0V = 5,0A

USB-C1/C2: PPS 3,30-21,0V = 5,0A 100,0 Вт MAX

USB-A1/A2 QC3.0: 5,0V = 3,0A, 9,0V = 2,0A, 12,0V = 1,5A, 18,0 Вт MAX

Несколько портов:

USB-C1+USB-C2: 65,0 Вт+30,0 Вт

USB-C1+USB-C2+USB-A1/A2: 45,0 Вт +30,0 Вт +18,0 Вт (QC3,0)

USB-C1/C2+USB-A1+USB-A2: 65,0 Вт +18,0 Вт (NO QC3,0)

USB-C1+USB-C2+USB-A1+USB-A2: 45,0 Вт +30,0 Вт +18,0 Вт (NO QC3,0)

Всего: 100,0 Вт макс.

Эксплуатационные характеристики

Параметр	Значение
Рабочая температура	От 0 до 35° C
Температура хранения	От -20 до 85° C
Относительная влажность	От 20 до 80 %, без конденсации
Влажность хранения	От 5 до 95 %, без конденсации
Высота длительного хранения	Не более 5000 м
Высота хранения	Не более 15 000 м

ВАЖНЫЕ УКАЗАНИЯ ПО ЗАМЕНЕ ВИЛОК ПЕРЕМЕННОГО ТОКА**Порядок действий**

1. Перед использованием проверьте наличие соответствующей сменной вилки переменного тока.

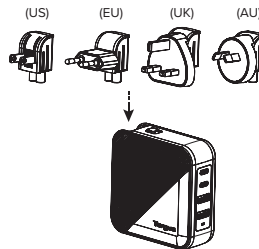

2. При замене вилки переменного тока сначала сдвиньте верхний рычаг вперед и снимите его (в качестве примера приведена вилка для США).

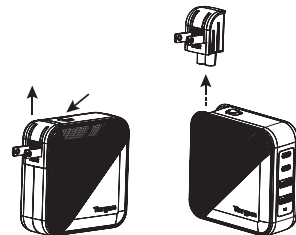

3. Вставьте соответствующую сменную вилку переменного тока для данной страны.

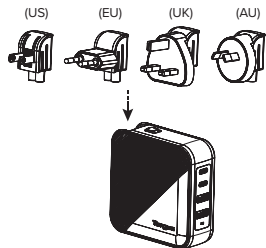

ПЕРЕД ИСПОЛЬЗОВАНИЕМ ОЗНАКОМЬТЕСЬ С ИНСТРУКЦИЯМИ

ВАЖНЫЕ ИНСТРУКЦИИ ПО ТЕХНИКЕ БЕЗОПАСНОСТИ

Указания по безопасности

1. Всегда обязательно убедитесь, что номинальное входное напряжение сетевого зарядного устройства соответствует розетке, которую предполагается использовать.
2. Сетевое зарядное устройство должно быть полностью вставлено в розетку. Никогда не используйте сетевое зарядное устройство, если его контакты открыты.
3. Перед включением в розетку убедитесь, что сменная вилка переменного тока подходит для данной страны.
4. Никогда не прикасайтесь к металлическим частям сетевого зарядного устройства во время его использования.
5. Устройство предназначено для использования только внутри помещения.
6. Если металлический контакт вилки переменного тока деформировался или расшатался, прекратите ее использование.

Если подключены оба порта USB-A, функция QC3.0 будет отключена

Один выходной порт

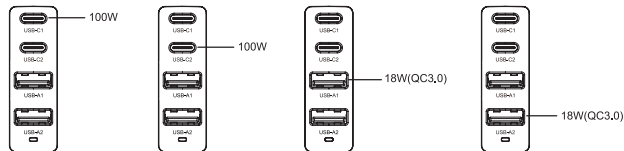

Два выходных порта

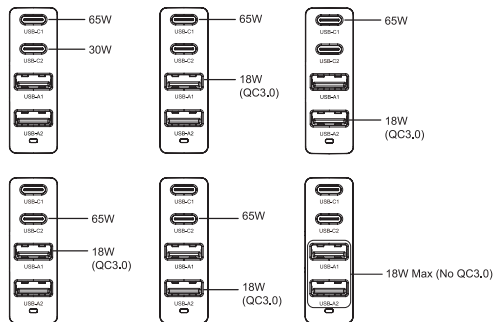

Три выходных порта

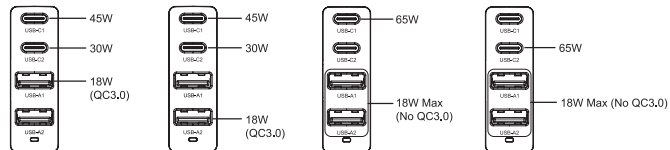

Все выходные порты

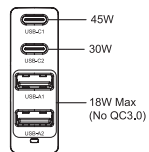

Информация о внешнем источнике питания

Производитель	Targus International LLC
Адрес	1211 North Miller Street, Anaheim, CA 92806 USA (США)
Коммерческий регистрационный номер	5892659
Модель/артикул	APA109
Входное напряжение	100–240 В перем. тока
Входная частота переменного тока	50/60 Гц
Выходное напряжение	Один порт USB-C1/C2 PD: 5,0 В/9,0 В/12,0 В/15,0 В ≙ 3,0 А, 20,0 В ≙ 5,0 А USB-C1/C2: PPS 3,30–21,0 В ≙ 5,0 А 100,0 Вт макс. USB-A1/A2 QC3.0: 5,0 В ≙ 3,0 А, 9,0 В ≙ 2,0 А, 12,0 В ≙ 1,5 А, 18,0 Вт макс.
Выходной ток	Несколько портов USB-C1+USB-C2: 65,0 Вт+30,0 Вт USB-C1+USB-C2+USB-A1/A2: 45,0 Вт+30,0 Вт+18,0 Вт (QC3.0) USB-C1+USB-C2+USB-A1+USB-A2: 65,0 Вт+18,0 Вт (NO QC3.0) USB-C1+USB-C2+USB-A1+USB-A2: 45,0 Вт+30,0 Вт+18,0 Вт (NO QC3.0)
Выходная мощность	100,0 Вт макс.

Средняя эффективность	<p>Несколько портов USB-C1+USB-C2+USB-A1+USB-A2: (5,0 В == 3,0 А+5,0 В == 3,0 А+5,0 В == 1,8 А+5,0 В == 1,8 А): 87,38 %</p> <p>USB-C1+USB-C2+USB-A1: (20,0 В == 2,25 А+20,0 В == 1,5 А+12,0 В == 1,5 А): 88,92 %</p> <p>Один порт USB-C1: 20,0 В == 5,0 А: 90,16 % USB-C1: 21,0 В == 4,76 А: 90,33 %</p>
Эффективность при низкой нагрузке (10 %)	<p>Несколько портов USB-C1+USB-C2+USB-A1+USB-A2: (5,0 В == 3,0 А+5,0 В == 3,0 А+5,0 В == 1,8 А+5,0 В == 1,8 А): 84,30 %</p> <p>USB-C1+USB-C2+USB-A1: (20,0 В == 2,25 А+20,0 В == 1,5 А+12,0 В == 1,5 А): 81,36 %</p> <p>Один порт USB-C1: 20,0 В == 5,0 А: 80,82 % USB-C1: 21,0 В == 4,76 А: 85,28 %</p>
Энергопотребление без нагрузки	0,094 Вт

Указанную выше информацию можно найти на сайте импортера www.targus.com.

Russian



Код изделия



Производитель : Targus International LLC

Tel: 1-714-765-5555

Адрес : 1211 North Miller Street,

Fax: 1-714-765-5599

Anaheim, CA 92806 USA

Internet: www.targus.com

Импортер: Targus Europe Ltd.

Tel: +44 (0)20 8831 2000

Адрес: Targus EMEA Account Management Van

Hilstraat 19, 5145 RK Waalwijk,

NETHERLANDS

Настоящим мы подтверждаем, что указанное изделие GaN AC Travel Adapter, Model No. ДРА109 Наименование бренда "TARGUS", соответствует Low Voltage Directive 2014/35/EU, Commission Regulation (EU) 2019/1782 / Erp Directive 2009/125/EC, EMC Directive 2014/30/EU, EU ROHS Directive 2011/65/EU and its amendment Directive (EU) 2015/863.

При проведении оценки в соответствии с вышеуказанными директивами принимались во внимание следующие стандарты:

Low-Voltage Directive: 2014/35/EU

EN IEC 62368-1:2020+A11:2020

EMC Directive: 2014/30/EU

EN 55032:2015+A1:2020

EN IEC 61000-3-2:2019+A1:2021

EN 61000-3-3:2013+A2:2021

EN 55035:2017+A11:2020

Erp Directive: COMMISSION REGULATION (EU) 2019/1782

RoHS Directive: 2011/65/EU and its amendment Directive (EU) 2015/863

EN IEC 63000:2018

Год применения маркировки CE: 2022

Директор, Targus - Global Sourcing Group

CF Ngoh

Должность

ФИО

7/28/2022

/ Hong Kong

Дата

/ Place of Issue



 Подпись от имени

SE Introduktion

Denna vägggladdare har GaN teknologi och utbytbara kontakter för internationell användning vilket möjliggör samtidig laddning av flera enheter såsom bärbara datorer, smartphones och andra USB-drivna enheter från olika varumärken såsom Apple, Dell, Google, Lenovo, Samsung och andra.

Innehåll

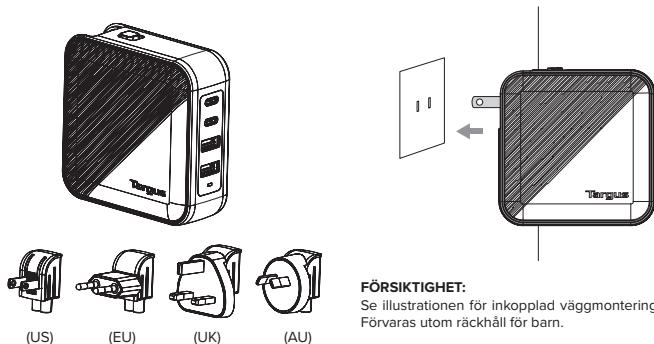
- Targus 100W GaN AC reseadapter
- AC-kontakt US, EU, Storbritannien, AU
- Bruksanvisning

**Elektrisk klassificering**

Inmatning: 100 - 240VAC 1.8A MAX 50/60Hz

Utmatning

Enskilt uttag:

USB-C1/C2 PD: 5.0V/9.0V/12.0V/15.0V = 3.0A, 20.0V = 5.0A

USB-C1/C2: PPS 3.30-21.0V = 5.0A 100.0W MAX

USB-A1/A2 QC3.0: 5.0V = 3.0A, 9.0V = 2.0A, 12.0V = 1.5A, 18.0W MAX

Multi Port:

USB-C1+USB-C2: 65.0W+30.0W

USB-C1+USB-C2+USB-A1/A2: 45.0W+30.0W+18.0W (QC3.0)

USB-C1/C2+USB-A1+USB-A2: 65.0W+18.0W (NO QC3.0)

USB-C1+USB-C2+USB-A1+USB-A2: 45.0W+30.0W+18.0W (NO QC3.0)

Totalt: 100,0W MAX

Hantering

Post	Krav
Drifttemperatur	0 till 35 °C
Förvaringstemperatur	-20 till 85 °C
Relativ luftfuktighet	20 % till 80 %, icke-kondenserande
Luftfuktighet för förvaring	5 % till 95 %, icke-kondenserande
Långtids altitud	Mindre än 5000 m
Förvaringsaltitud	Mindre än 15000 m

VIKTIGA INSTRUKTIONER FÖR LADDNING MED UTBYTBARA KONTAKTER

Procedurer:

1. Bekräfta lämplig utbyttbar AC-kontakt innan användning.

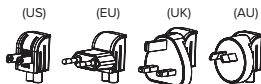

2. Vid laddning med den utbyttbara AC-kontakten (US AC-kontakt illustreras som exempel proceduren), skjut först övre spaken framåt och ta bort den.

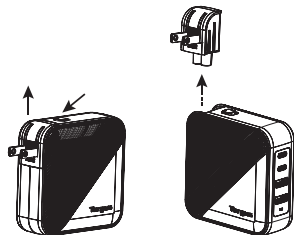

3. Skjut på den lämpliga utbyttbara AC-kontakten för det land där du befinner dig.

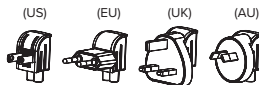

LÄS IGENOM ALLA INSTRUKTIONER INNAN ANVÄNDNING

VIKTIGA SÄKERHETSINSTRUKTIONER

Säkerhetsåtgärder

1. Se alltid till att inmatad märkspänning från vägguttaget är kompatibel med det uttag som du använder.
2. Väggladdaren måste vara helt isatt i uttaget. Använd aldrig väggladdaren om stiftet eller bladen är exponerade.
3. Bekräfta att den utbyttbara C-kontakten är lämplig för det land där du befinner dig innan den kopplas in i uttaget.
4. Vidrör aldrig metalldelarna i väggladdaren under användning.
5. Produkten är endast designad för inomhusbruk.
6. Om metallpinnen på AC-kontakten blir deformerad eller är lös skall kontakten inte användas.

Om båda USB-A uttagen är anslutna, kommer QC3.0 funktionen att vara avaktiverad

Utmatning enskilt uttag:

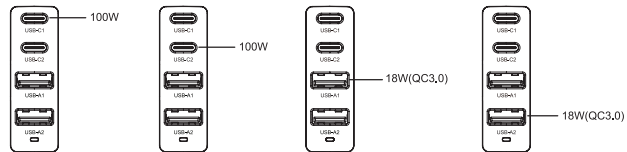

Utmatning dubbla uttag:

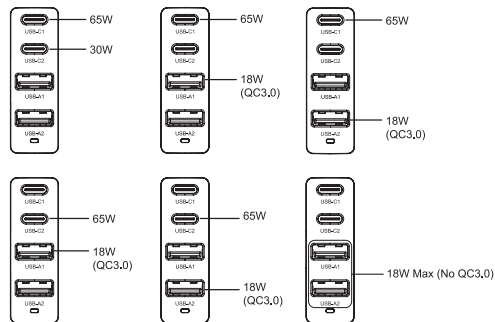

Utmatning tre uttag:

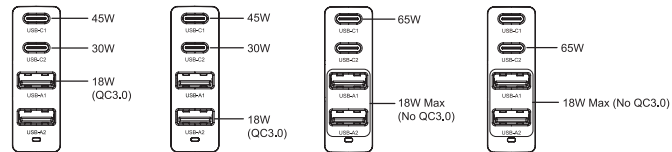

Utmatning alla uttag:

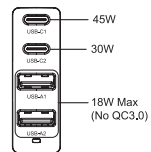

Information extern strömförsörjning

Tillverkare	Targus International LLC
Adress	1211 North Miller Street, Anaheim, CA 92806 USA
Kommersiell Registreringsnummer	5892659
Modell/registrering	APA109
Ingående spänning	100-240V~
Inmatning AC frekvens	50/60Hz
Utgående spänning	Enskilt uttag: USB-C1/C2 PD: 5,0V/9,0V/12,0V/15,0V = 3,0A, 20,0V = 5,0A USB-C1/C2: PPS 3,30-21,0V = 5,0A 100,0W MAX USB-A1/A2 QC3.0: 5,0V = 3,0A, 9,0V = 2,0A, 12,0V = 1,5A, 18,0V MAX
Utmatad ström	Multi Port: USB-C1+USB-C2: 65,0W+30,0W USB-C1+USB-C2+USB-A1/A2: 45,0W+30,0W+18,0W (QC3,0) USB-C1/USB-C2+USB-A1+USB-A2: 65,0W+18,0W (NO QC3,0) USB-C1+USB-C2+USB-A1+USB-A2: 45,0W+30,0W+18,0W (NO QC3,0)
Utmatad effekt	100.0W MAX

Aktiv effekt i medeltal	Multi Port: USB-C1+USB-C2+USB-A1+USB-A2: (5,0V = 3,0A+5,0V = 3,0A+5,0V = 1,8A+5,0V = 1,8A):87,38 % USB-C1+USB-C2+USB-A1: (20,0V = 2,25A+20,0V = 1,5A+12,0V = 1,5A):88,92 % Enskilt uttag: USB-C1: 20,0V = 5,0A:90,16 % USB-C1: 21,0V = 4,76A:90,33 %
Effekt vid låg belastning (10 %)	Multi Port: USB-C1+USB-C2+USB-A1+USB-A2: (5,0V = 3,0A+5,0V = 3,0A+5,0V = 1,8A+5,0V = 1,8A):84,30 % USB-C1+USB-C2+USB-A1: (20,0V = 2,25A+20,0V = 1,5A+12,0V = 1,5A):81,36 % Enskilt uttag: USB-C1: 20,0V = 5,0A:80,82 % USB-C1: 21,0V = 4,76A:85,28 %
Energiförbrukning obelastad	0.094W

Övnanstående information kan hittas på importörens hemsida www.targus.com

TR Giriş

GaN teknolojisine ve uluslararası kullanım için değiştirilebilir fişlere sahip bu duvar şarj cihazı, Apple, Dell, Google, Lenovo, Samsung ve başka markalar dahil olmak üzere çeşitli markalardan dizüstü bilgisayarlar, tabletler, akıllı telefonlar ve diğer USB ile güç sağlanan cihazların aynı anda birden fazlasının şarj edilebilmesini sağlar.

İçindekiler

- Targus 100W GaN AC seyahat adaptörü
- ABD, AB, Birleşik Krallık, Avustralya tipi AC fiş
- Kullanıcı Kılavuzu

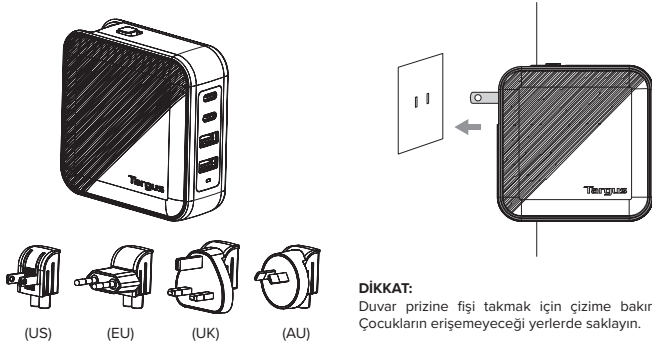
**Elektrik Gereksinimleri**

Giriş: 100 - 240VAC 1.8A MAX 50/60Hz

Çıkış:

Tek Bağlantı Noktası:

USB-C1/C2 PD: 5.0V/9.0V/12.0V/15.0V = 3.0A, 20.0V = 5.0A

USB-C1/C2: PPS 3.30-21.0V = 5.0A 100.0W MAX

USB-A1/A2 QC3.0: 5.0V = 3.0A, 9.0V = 2.0A, 12.0V = 1.5A, 18.0W MAX

Çoklu Bağlantı Noktası:

USB-C1+USB-C2: 65.0W+30.0W

USB-C1+USB-C2+USB-A1/A2: 45.0W+30.0W+18.0W (QC3.0)

USB-C1/C2+USB-A1+USB-A2: 65.0W+18.0W (NO QC3.0)

USB-C1+USB-C2+USB-A1+USB-A2: 45.0W+30.0W+18.0W (NO QC3.0)

Toplam: 100.0W MAX

Çalışması

İşlev	Gereksinimler
Çalışma sıcaklığı	0° ila 35°C
Depolama sıcaklığı	-20° ila 85°C
Bağıl nem	%20 ila %80, yoğuşmasız
Depolama nemi	%5 ila %95, yoğuşmasız
Uzun süreli yükseklik	5000 m'den az
Depolama yüksekliği	15000 m'den az

DEĞİŞTİRİLEBİLİR AC FİŞLERİN DEĞİŞTİRİLMESİ İÇİN ÖNEMLİ TALİMATLAR

Prosedürler:

1. Kullanmadan önce değiştirilebilir AC fişinin uygunluğunu onaylayın.

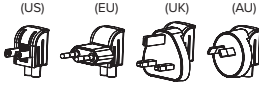

2. Değiştirilebilir AC fişini değiştirirken (prosedürleri göstermek için örnek olarak ABD tipi AC fişi kullanılmıştır) önce üst kolu ileri kaydırın ve çıkarın.

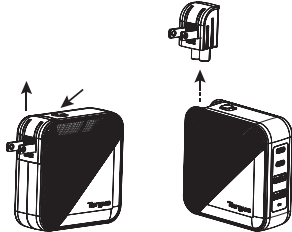

3. Bulduğunuz ülkeye uygun değiştirilebilir AC fişini takın.

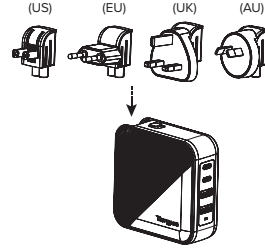

KULLANMADAN ÖNCE TÜM TALİMATLARI OKUYUN

ÖNEMLİ GÜVENLİK TALİMATLARI

Güvenlik Önlemleri

1. Duvar şarj cihazının nominal giriş voltajının kullanmayı planladığınız priz çıkışı değeri ile uyumlu olduğundan daima emin olun.
2. Duvar şarj cihazı prize tam olarak takılmalıdır. Pim veya uç kısmı açıktaysa asla duvar şarj cihazını kullanmayın.
3. Fişi prize takmadan önce değiştirilebilir AC fişinin bulunduğunuz ülkeye uygun olduğundan emin olun.
4. Kullanım sırasında duvar şarj cihazının herhangi bir metal parçasına asla dokunmayın.
5. Ürün sadece kapalı alanda kullanım için tasarlanmıştır.
6. AC fişlerinin metal pimi deforme olursa veya gevşerse ürünü kullanmayı bırakın.

Her iki USB-A bağlantı noktası bağlıysa, QC3.0 özelliği devre dışı bırakılır

Çıkış Tek Bağlantı Noktası:

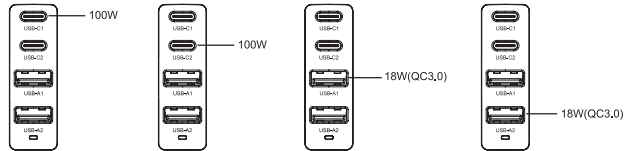

Çıkış Çift Bağlantı Noktası:

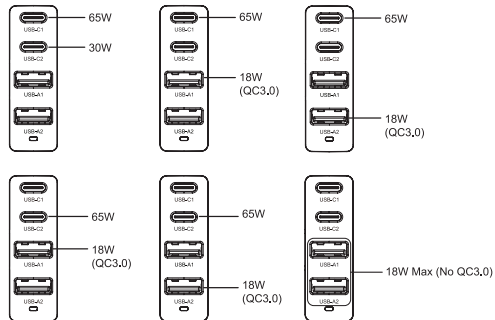

Çıkış Üç Bağlantı Noktası:

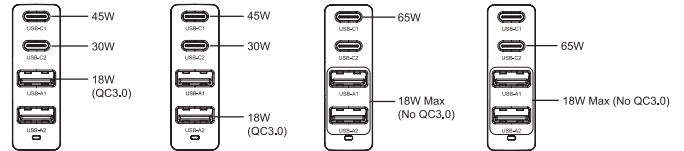

Çıkış Tüm Bağlantı Noktaları:

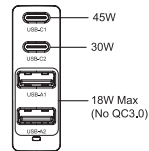

Harici Güç Kaynağı Bilgileri

Üretici	Targus International LLC
Adres	1211 North Miller Street, Anaheim, CA 92806 ABD
Ticari Sicil Numarası	5892659
Model/Reg	APA109
Giriş voltajı	100-240V~
Giriş AC frekansı	50/60Hz
Çıkış voltajı	Tek Bağlantı Noktası: USB-C1/C2 PD: 5.0V/9.0V/12.0V/15.0V = 3.0A, 20.0V = 5.0A USB-C1/C2: PPS 3.30-21.0V = 5.0A 100.0W MAX USB-A1/A2 QC3.0: 5.0V = 3.0A, 9.0V = 2.0A, 12.0V = 1.5A, 18.0W MAX
Çıkış akımı	Çoklu Bağlantı Noktası: USB-C1+USB-C2: 65.0W+30.0W USB-C1+USB-C2+USB-A1/A2: 45.0W+30.0W+18.0W (QC3.0) USB-C1/USB-C2+USB-A1+USB-A2: 65.0W+18.0W (NO QC3.0) USB-C1+USB-C2+USB-A1+USB-A2: 45.0W+30.0W+18.0W (NO QC3.0)
Çıkış gücü	100.0W MAX

Ortalama aktif verimlilik	Çoklu Bağlantı Noktası: USB-C1+USB-C2+USB-A1+USB-A2: (5.0V = 3.0A+5.0V = 3.0A+5.0V = 1.8A+5.0V = 1.8A):%87.38 USB-C1+USB-C2+USB-A1: (20.0V = 2.25A+20.0V = 1.5A+12.0V = 1.5A):%88.92 Tek Bağlantı Noktası: USB-C1: 20.0V = 5.0A:%90.16 USB-C1: 21.0V = 4.76A:%90.33
Düşük yükte (% 10) verimlilik	Çoklu Bağlantı Noktası: USB-C1+USB-C2+USB-A1+USB-A2: (5.0V = 3.0A+5.0V = 3.0A+5.0V = 1.8A+5.0V = 1.8A):%84.30 USB-C1+USB-C2+USB-A1: (20.0V = 2.25A+20.0V = 1.5A+12.0V = 1.5A):%81.36 Tek Bağlantı Noktası: USB-C1: 20.0V = 5.0A:%80.82 USB-C1: 21.0V = 4.76A:%85.28
Yüksüz güç tüketimi	0.094W

Yukarıdaki bilgiler www.targus.com adresindeki ithalatçı web sitesinde bulunabilir

TURKISH

Targus

Uyumluluk Bildirimi



Üretici:	Targus International LLC	Tel:	1-714-765-5555
Adres:	1211 North Miller Street, Anaheim, CA 92806 USA	Faks:	1-714-765-5599
İthalatçı:	Targus Europe Ltd.	İnternet:	www.targus.com
Firma:	Targus EMEA Account Management,	Tel:	+44 (0)20 8831 2000
Adres:	Van Hilstraat 19, 5145 RK Waalwijk, NETHERLANDS		

Bu belge ile aşağıda detayları verilen GaN AC Travel Adapter, Model No. APA109 Marka adı "TARGUS" ürününün, Low Voltage Directive 2014/35/EU, Commission Regulation (EU) 2019/1782 / ErP Directive 2009/125/EC, EMC Directive 2014/30/EU, EU RoHS Directive 2011/65/EU and its amendment Directive (EU) 2015/863.

Yukarıdaki Yönetmelere ilişkin doğruladım için aşağıda verilen standartlar uygulanmıştır:

Low-Voltage Directive: 2014/35/EU
EN IEC 62368-1:2020+A11:2020

EMC Directive: 2014/30/EU
EN 55032:2015+A1:2020
EN IEC 61000-3-2:2019+A1:2021

EN 61000-3-3:2013+A2:2021
EN 55035:2017+A1:2020

Erp Directive: COMMISSION REGULATION (EU) 2019/1782

RoHS Directive: 2011/65/EU and its amendment Directive (EU) 2015/863
EN IEC 63000:2018

CE işaretinin başlangıç yılı: 2022

Direktör, Targus - Global Kaynak Kullanım

Grubu

CF Ngoh

İşlev Unvanı

Adı

7/28/2022 / Hong Kong

Tarih / Düzenleme Yeri

Targus için ve Targus adına imzalanmıştır

ES Introducción

Este cargador de pared con tecnología GaN y enchufes intercambiables para uso internacional permite la carga simultánea de varios dispositivos, como ordenadores portátiles, tabletas, smartphones y otros dispositivos alimentados por USB de varias marcas, tales como Apple, Dell, Google, Lenovo y Samsung, entre otros.

Contenido

- Adaptador de viaje Targus 100W GaN AC
- Enchufes de CA para EE.UU., UE, Reino Unido, AU
- Guía del usuario

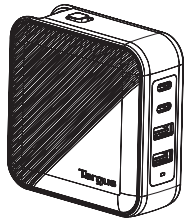

(US)



(EU)



(UK)

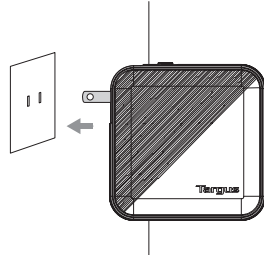

(AU)

**ATENCIÓN:**

Consulte la ilustración para enchufar a una toma de corriente. Mantenga fuera del alcance de los niños.

Clasificación eléctrica

Entrada: 100 - 240 VAC 1,8A MAX 50/60 Hz

Salida:

Puerto individual:

USB-C1/C2 PD: 5,0 V/9,0 V/12,0 V/15,0 V = 3,0 A, 20,0 V = 5,0 A

USB-C1/C2: PPS 3,30 - 21,0V = 5,0A 100,0W MAX

USB-A1/A2 QC3,0: 5,0 V = 3,0 A, 9,0 V = 2,0 A, 12,0 V = 1,5 A, 18,0 W MAX

Múltiples puertos:

USB-C1 + USB-C2: 65,0 W + 30,0 W

USB-C1 + USB-C2 + USB-A1/A2: 45,0W + 30,0W + 18,0W (QC3,0)

USB-C1/C2 + USB-A1 + USB-A2: 65,0W + 18,0W (NO QC3,0)

USB-C1 + USB-C2 + USB-A1 + USB-A2: 45,0W + 30,0W + 18,0W (NO QC3,0)

Total: 100,0 W MÁX.

Funcionamiento

Artículo	Requisitos
Temperatura operativa	0 °C a 35 °C
Temperatura de almacenamiento	-20 °C a 85 °C
Humedad relativa	20% a 80%, sin condensación
Humedad de almacenamiento	5% a 95%, sin condensación
Altitud a largo plazo	Menos de 5000 m
Altitud de almacenamiento	Menos de 15 000 m

INSTRUCCIONES IMPORTANTES PARA CAMBIAR LOS ENCHUFES DE CA INTERCAMBIABLES**Procedimientos:**

1. Confirme el enchufe de CA intercambiable adecuado antes de utilizarlo.

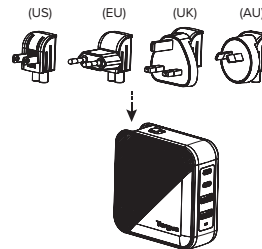

2. Cuando cambie el enchufe de CA intercambiable (enchufe de CA de EE.UU. como ejemplo para ilustrar los procedimientos), deslice primero la palanca superior hacia adelante y retírela.

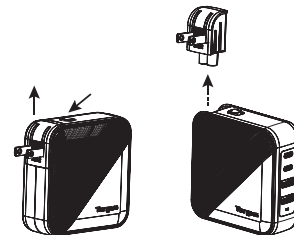

3. Introduzca el enchufe de CA intercambiable adecuado para el país en el que se encuentra.

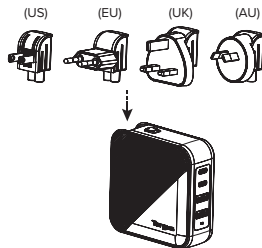

LEA TODAS LAS INSTRUCCIONES ANTES DE USAR EL PRODUCTO

MEDIDAS DE SEGURIDAD IMPORTANTES

Medidas de seguridad

1. Asegúrese siempre de que la tensión nominal de entrada del cargador de pared es compatible con la toma de corriente que va a utilizar.
2. El cargador de pared debe estar completamente insertado en la toma de corriente. No utilice nunca el cargador de pared si la clavija o la cuchilla están expuestas.
3. Confirme que el enchufe de CA intercambiable es apropiado para el país en el que se encuentra antes de conectarlo a la toma de corriente.
4. No toque nunca ninguna parte metálica del cargador de pared cuando esté en uso.
5. El producto está diseñado para su uso en interiores únicamente.
6. Si la clavija metálica de los enchufes de CA se deforma o se afloja, deje de utilizarlos.

La función QC3.0 se desactiva si ambos puertos USB-A están conectados.

Salida por un puerto:

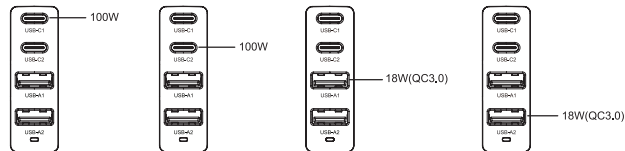

Salida por dos puertos:

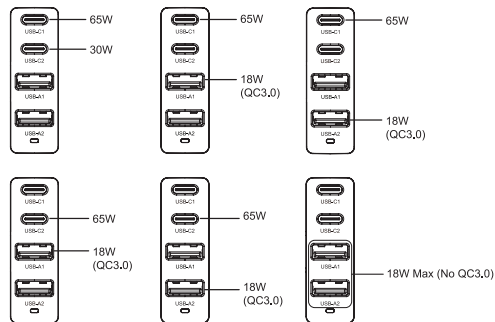

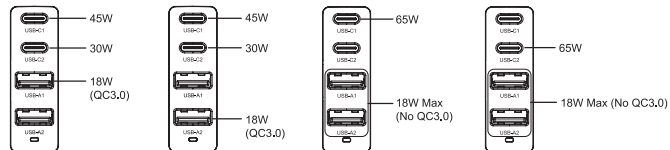
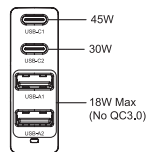
Salida por tres puertos:**Salida por todos los puertos:****Información de fuente de alimentación externa**

Fabricante	Targus International LLC
Dirección postal	1211 North Miller Street, Anaheim, CA 92806 USA
Número de registro comercial	5892659
Modelo/Reg.	APA109
Tensión de entrada	100-240 V \sim
Frecuencia CA de entrada	50/60 Hz
Tensión de salida	<p>Puerto individual: USB-C1/C2 PD: 5,0 V/9,0 V/12,0 V / 15,0 V = 3,0 A, 20,0 V = 5,0 A USB-C1/C2: PPS 3,30 - 21,0 V = 5,0 A 100,0 W MAX USB-A1/A2 QC3.0: 5,0 V = 3,0 A, 9,0 V = 2,0 A, 12,0 V = 1,5 A, 18,0 W MAX</p> <p>Múltiples puertos: USB-C1 + USB-C2: 65,0 W + 30,0 W USB-C1 + USB-C2 + USB-A1/A2: 45,0 W + 30,0 W + 18,0 W (QC3.0) USB-C1/USB-C2 + USB-A1 + USB-A2: 65,0 W + 18,0 W (NO QC3.0) USB-C1 + USB-C2 + USB-A1 + USB-A2: 45,0 W + 30,0 W + 18,0 W (NO QC3.0)</p>
Corriente de salida	
Potencia de salida	100,0 W MÁX.

Eficiencia activa promedio	Múltiples puertos: USB-C1 + USB-C2 + USB-A1 + USB-A2: (5,0 V = 3,0 A + 5,0 V = 3,0 A + 5,0 V = 1,8 A + 5,0 V = 1,8 A): 87,38 % USB-C1 + USB-C2 + USB-A1: (20,0 V = 2,25 A + 20,0 V = 1,5 A + 12,0 V = 1,5 A): 88,92 % Puerto individual: USB-C1: 20,0 V = 5,0 A: 90,16% USB-C1: 21,0 V = 4,76 A: 90,33%
Eficiencia a cargas bajas (10%)	Múltiples puertos: USB-C1 + USB-C2 + USB-A1 + USB-A2: (5,0 V = 3,0 A + 5,0 V = 3,0 A + 5,0 V = 1,8 A + 5,0 V = 1,8 A): 84,30 % USB-C1 + USB-C2 + USB-A1: (20,0 V = 2,25 A + 20,0 V = 1,5 A + 12,0 V = 1,5 A): 81,36 % Puerto individual: USB-C1: 20,0 V = 5,0 A: 80,82% USB-C1: 21,0 V = 4,76 A: 85,28%
Consumo de energía sin carga	0,094 W

La información anterior está disponible en www.targus.com

SPANISH



Declaración de conformidad con la normativa vigente

Fabricante:	Targus International LLC	Tel:	1-714-765-5555
Dirección:	1211 North Miller Street, Anaheim, CA 92806 EE. UU.	Fax:	1-714-765-5599
Importador:	Targus Europe Ltd.	Internet:	www.targus.com
Dirección:	Targus EMEA Account Management, Van Hilstraat 19, 5145 RK Waalwijk, NETHERLANDS	Tel:	+44 (0)20 8831 2000

Por medio de la presente confirmamos que el producto denominado GaN AC Travel Adapter, con referencias nº ΔPA102 de la marca "TARGUS", cumple con las normativas Low Voltage Directive, 2014/35/EU, Commission Regulation (EU) 2019/1782 de ErP Directive 2009/125/EC, EMC Directive, 2014/30/EU, EU RoHS Directive 2011/65/EU and its amendment Directive (EU) 2015/863.

A fin de evaluar el cumplimiento de las normativas anteriores se aplicaron los estándares siguientes:

Low-Voltage Directive: 2014/35/EU
EN IEC 62368-1:2020+A11:2020
EMC Directive: 2014/30/EU
EN 55032:2015+A1:2020
EN IEC 61000-3-2:2019+A1:2021
EN 61000-3-3:2013+A2:2021
EN 55035:2017+A11:2020

Erp Directive: COMMISSION REGULATION (EU) 2019/1782

RoHS Directive: 2011/65/EU and its amendment Directive (EU) 2015/863
EN IEC 63000:2018

Año a partir del que se usa la marca CE: 2022

Director, Targus – Distribuidora mundial

Cargo

CF Ngoh

Nombre

7/28/2022 / Hong Kong

Fecha / Lugar de emisión

Firmado por y en nombre de Targus

AR مقدمة

وقوابس قابلة للتبديل للاستخدام العالمي، وهو ما يجعلك قادراً على شحن عدة GaN شاحن الحائط هذا مجهز بتقنية أجهزة مختلفة في نفس الوقت من الحواسيب المحمولة والحواسيب اللوحية والهواتف الذكية والأجهزة الأخرى العاملة عبر USB. وغيرها Samsung وLenovo وGoogle وApple ومن بينها أجهزة USB.

المحتويات

- Targus بقدرة 100 واط من GaN مهائي طاقة التيار المتردد المتنقل بتقنية
- قابس تيار متردد على نمط الولايات المتحدة الأمريكية والاتحاد الأوروبي والمملكة المتحدة وأستراليا
- دليل المستخدم

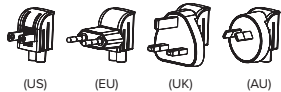
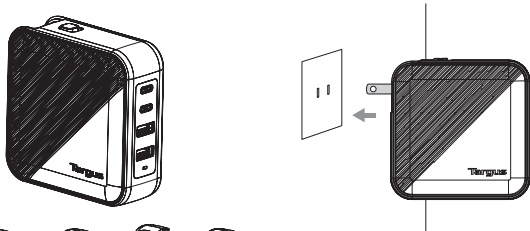
**تنبيه:**

راجع الأشكال التوضيحية للتعرف على تركيب القابس في الحائط.
احتفظ بالمنتج بعيداً عن متناول الأطفال.

التصنيف الكهربائي المقدر

لإخداً لاقاط: 100 - 240VAC 1.8A MAX 50/60Hz

جأخداً لاقاط:

دحاو ذفانم:

USB-C1/C2 PD: 5.0V/9.0V/12.0V/15.0V = 3.0A, 20.0V = 5.0A

USB-C1/C2: PPS 3.30-21.0V = 5.0A 100.0W MAX

USB-A1/A2 QC3.0: 5.0V = 3.0A, 9.0V = 2.0A, 12.0V = 1.5A, 18.0V MAX

ةدعدتم ذفانم

USB-C1+USB-C2: 65.0W+30.0W

USB-C1+USB-C2+USB-A1/A2: 45.0W+30.0W+18.0W (QC3.0)

USB-C1/C2+USB-A1+USB-A2: 65.0W+18.0W (NO QC3.0)

USB-C1+USB-C2+USB-A1+USB-A2: 45.0W+30.0W+18.0W (NO QC3.0)

الإجمالي: 100.0 واط كحد أقصى

التشغيل

العنصر	المتطلبات
درجة حرارة التشغيل	إلى 35 درجة مئوية 0
درجة حرارة التخزين	إلى 85 درجة مئوية -20
الرطوبة النسبية	إلى 80% بدون تكاثف 20%
رطوبة التخزين	إلى 95% بدون تكاثف 5%
الارتفاع عن سطح البحر لفترة طويلة	أقل من 5000 متر
الارتفاع عن سطح البحر عند التخزين	أقل من 15000 متر

تعليمات هامة حول تغيير قواسب التيار المتردد القابلة للتبديل

الإجراءات:

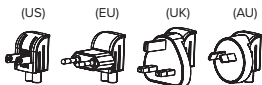

1. افحص قابس التيار المتردد القابل للتبديل المناسب قبل استخدامه.



2. عند تغيير قابس التيار المتردد القابل للتبديل (قابس التيار المتردد على نمط الولايات المتحدة الأمريكية كمثال لتوضيح الإجراءات)، حرك الرافعة العلوية للأمام أولاً، ثم اخلعها.

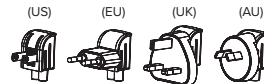

3. أدخل قابس التيار المتردد القابل للتبديل المناسب للبلد الذي توجد به حاليًا.



اقرأ جميع التعليمات قبل الاستخدام

تعليمات سلامة هامة

احتياطات الأمان

1. تأكد دائمًا من توافق جهد الإدخال المقدر لشاحن الحائط مع جهد الإخراج للمقبس الذي تنوي استخدامه.
2. يجب إدخال شاحن الحائط بالكامل في المقبس. لا تستخدم شاحن الحائط مطلقًا إذا كان طرف الشاحن أو شفرته مكشوفًا.
3. تأكد من توافق قابس التيار المتردد القابل للتبديل مع البديل الذي توجد به حاليًا، قبل توصيله في مقبس التيار.
4. لا تلمس مطلقًا أي جزء معدني من شاحن الحائط أثناء الاستخدام.
5. هذا المنتج مصمم للاستخدام المنزلي فقط.
6. إذا كان الطرف المعدني لقواسب التيار المتردد مشوهًا أو مفكوكًا، فتوقف عن استخدامه على الفور.

QC3.0 سيتم تعطيل خاصية USB-A، إذا تم توصيل كلا منفذي

الإخراج من منفذ واحد:

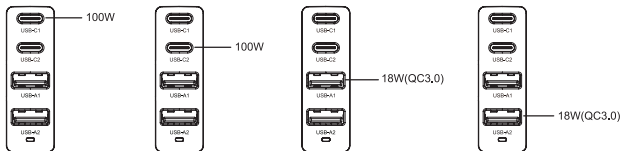

الإخراج من منفذين:

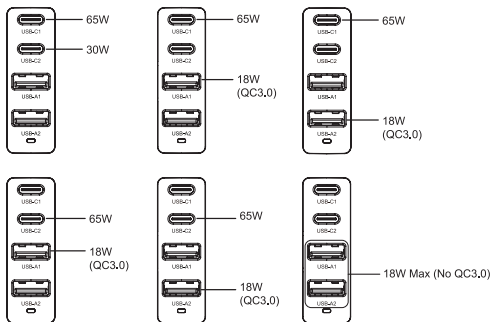

الإخراج من ثلاثة منافذ:

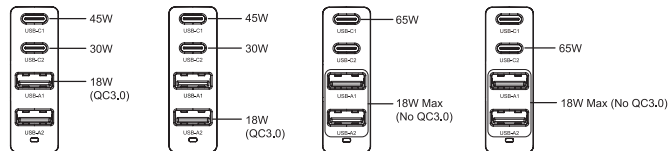

الإخراج من جميع المنافذ:

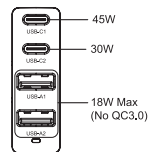

معلومات مصدر الطاقة الخارجي

الشركة الصانعة	Targus International LLC
العنوان	الولايات المتحدة الأمريكية، 1211 North Miller Street, Anaheim, CA 92806
تجارياً رقم التسجيل	APA109
الطراز/التسجيل	- فولت 100-240
جهد الإدخال	هرتز 50/60
تردد تيار الدخل	50/60Hz
جهد الخرج	منفذ واحد فولت/9.0 فولت/12.0 فولت/15.0 فولت = 3.0 أمبير USB-C1/C2 PD: 5.0 فولت = 5.0 أمبير 20.0
تيار الخرج	فولت = 5.0 أمبير 100.0 واط كحد أقصى USB-C1/C2: PPS 3.30-21.0 فولت = 3.0 أمبير، 9.0 فولت = 2.0 أمبير، 12.0 فولت = 1.5 أمبير USB-A1/A2 QC3.0: 5.0 أمبير، 18.0 واط كحد أقصى منافذ متعددة واط+30.0 واط USB-C1+USB-C2: 65.0 واط+18.0 واط USB-C1+USB-C2+USB-A1/A2: 45.0 واط+18.0 واط (بدون USB-C1/USB-C2+USB-A1+USB-A2: 65.0 واط+30.0 واط+18.0 واط (بدون USB-C1+USB-C2+USB-A1+USB-A2: 45.0
طاقة الخرج	كحد أقصى 0

متوسط كفاءة الطاقة	منافذ متعددة فولت = 3.0 أمبير+5.0 فولت = 5.0 فولت USB-C1+USB-C2+USB-A1+USB-A2: (5.0 3.0 أمبير+5.0 فولت = 1.8 أمبير+5.0 فولت = 1.8 أمبير):87.38% فولت = 2.25 أمبير+20.0 فولت = 1.5 فولت USB-C1+USB-C2+USB-A1: (20.0 أمبير+12.0 فولت = 1.5 أمبير):88.92% منفذ واحد فولت = 5.0 أمبير:90.16% USB-C1: 20.0 فولت = 4.76 أمبير:90.33% USB-C1: 21.0
الكفاءة عند التحميل المنخفض (10%)	منافذ متعددة فولت = 3.0 أمبير+5.0 فولت = 5.0 فولت USB-C1+USB-C2+USB-A1+USB-A2: (5.0 3.0 أمبير+5.0 فولت = 1.8 أمبير+5.0 فولت = 1.8 أمبير):84.30% فولت = 2.25 أمبير+20.0 فولت = 1.5 فولت USB-C1+USB-C2+USB-A1: (20.0 أمبير+12.0 فولت = 1.5 أمبير):81.36% منفذ واحد فولت = 5.0 أمبير:80.82% USB-C1: 20.0 فولت = 4.76 أمبير:85.28% USB-C1: 21.0
استهلاك الطاقة بدون حمل	094 واط

www.targus.com يمكنك التعرف على المعلومات أعلاه من خلال الموقع الإلكتروني الخاص بالمستورد

BG Увод

Това стенно зарядно устройство с GaN технология и сменяеми щепсели за международна употреба позволява едновременно зареждане на няколко устройства като лаптопи, таблети, смартфони и други USB захранвани устройства от различни марки, включително Apple, Dell, Google, Lenovo, Samsung и други.

Съдържание

- Променливотоков туристически адаптер Targus 100W GaN
- US, EU, UK, AU променливотоков щепсел
- Потребителски наръчник

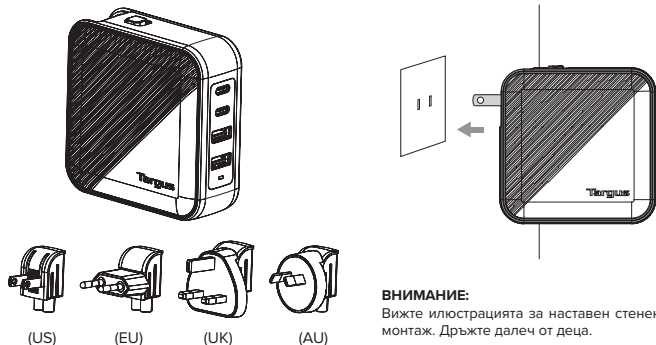
**ВНИМАНИЕ:**

Вижте илюстрацията за наставен стенен монтаж. Дръжте далеч от деца.

Електрически характеристики

Вход: 100 - 240VAC 1.8A MAX 50/60Hz

Изход:

Единичен порт:

USB-C1/C2 PD: 5.0V/9.0V/12.0V/15.0V \Rightarrow 3.0A, 20.0V \Rightarrow 5.0A

USB-C1/C2: PPS 3.30-21.0V \Rightarrow 5.0A 100.0W MAX

USB-A1/A2 QC3.0: 5.0V \Rightarrow 3.0A, 9.0V \Rightarrow 2.0A, 12.0V \Rightarrow 1.5A, 18.0W MAX

Много портове:

USB-C1+USB-C2: 65.0W+30.0W

USB-C1+USB-C2+USB-A1/A2: 45.0W+30.0W+18.0W (QC3.0)

USB-C1/C2+USB-A1+USB-A2: 65.0W+18.0W (NO QC3.0)

USB-C1+USB-C2+USB-A1+USB-A2: 45.0W+30.0W+18.0W (NO QC3.0)

Общо: 100.0W MAX

Работа

Позиция	Изисквания
Работна температура	0° до 35°C
Температура на съхранение	-20° до 85°C
Относителна влажност	20% до 80%, без кондензация
Влажност при съхранение	5% до 95%, без кондензация
Дългосрочна надморска височина	По-малко от 5000 m
Надморска височина при съхранение	По-малко от 15000 m

ВАЖНИ ИНСТРУКЦИИ ЗА ЗАМЯНА НА СМЕНЯЕМИТЕ ЩЕПСЕЛИ ЗА ПРОМЕНЛИВ ТОК

Процедури:

1. Потвърдете подходящия сменяем щепсел за променлив ток преди употреба.

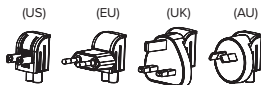

2. При замяна на сменяемия щепсел за променлив ток (US щепсел за променлив ток като пример за илюстриране на процедурите) плъзнете първо горния лост напред, и го отстранете.

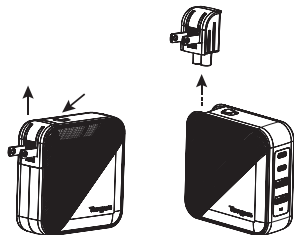

3. Плъзнете навътре подходящия сменяем щепсел за променлив ток за страната, в която се намирате.

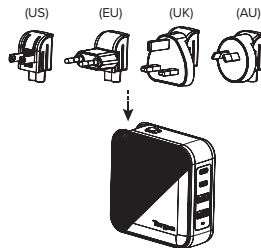

ПРОЧЕТЕТЕ ВСИЧКИ ИНСТРУКЦИИ ПРЕДИ УПОТРЕБА

ВАЖНИ ИНСТРУКЦИИ ЗА БЕЗОПАСНОСТ

Предпазни мерки за безопасност

1. Винаги се уверявайте, че номиналното входно напрежение на стенното зарядно устройство е съвместимо с контакта, който смятате да използвате.
2. Стенното зарядно устройство трябва да бъде напълно вкарано в контакта. Никога не използвайте стенното зарядно устройство, ако щифтът или перото са открити.
3. Уверете се, че сменяемият щепсел за променлив ток е подходящ за страната в която се намирате, преди да го вкарате в контакта.
4. Не се допирайте в каквато и да било метална част на стенното зарядно устройство, когато е в употреба.
5. Продуктът е проектиран само за употреба на закрито.
6. Ако металният щифт на щепсела за променлив ток се деформира или разхлаби, прекратете употребата.

Ако са свързани и двата порта USB-A, функцията QC3.0 ще бъде деактивирана

Изход единичен порт:

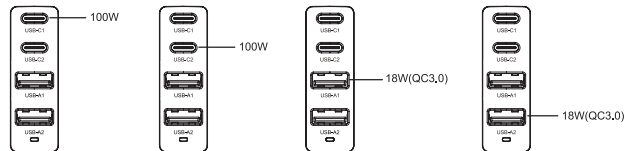

Изход два порта:

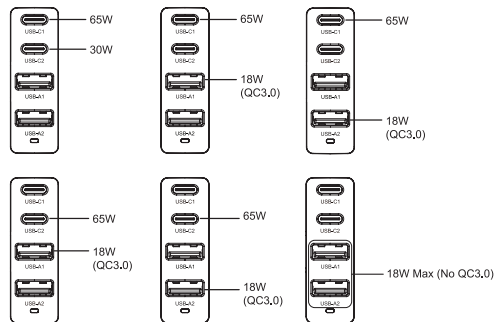

Изход три порта:

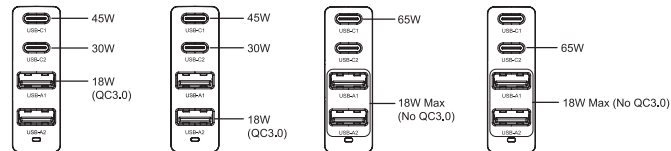

Изход всички портове:

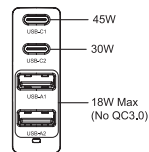

Информация за външно електрозахранване

Производител	Targus International LLC
Адрес	1211 North Miller Street, Anaheim, CA 92806 САЩ
Търговски Регистрационен номер	5892659
Модел/рег.	APA109
Входно напрежение	100-240V~
Входна променливотокова честота	50/60Hz
Изходно напрежение	Единичен порт: USB-C1/C2 PD: 5.0V/9.0V/12.0V/15.0V = 3.0A, 20.0V = 5.0A USB-C1/C2: PPS 3.30-21.0V = 5.0A 100.0W MAX USB-A1/A2 QC3.0: 5.0V = 3.0A, 9.0V = 2.0A, 12.0V = 1.5A, 18.0W MAX
Изходен ток	Много портове: USB-C1+USB-C2: 65.0W+30.0W USB-C1+USB-C2+USB-A1/A2: 45.0W+30.0W+18.0W (QC3.0) USB-C1/USB-C2+USB-A1+USB-A2: 65.0W+18.0W (NO QC3.0) USB-C1+USB-C2+USB-A1+USB-A2: 45.0W+30.0W+18.0W (NO QC3.0)
Изходна мощност	100.0W MAX

Средна активна ефективност	Много портове: USB-C1+USB-C2+USB-A1+USB-A2: (5.0V = 3.0A+5.0V = 3.0A+5.0V = 1.8A+5.0V = 1.8A):87.38% USB-C1+USB-C2+USB-A1: (20.0V = 2.25A+20.0V = 1.5A+12.0V = 1.5A):88.92% Единичен порт: USB-C1: 20.0V = 5.0A:90.16% USB-C1: 21.0V = 4.76A:90.33%
Ефективност при нисък товар (10 %)	Много портове: USB-C1+USB-C2+USB-A1+USB-A2: (5.0V = 3.0A+5.0V = 3.0A+5.0V = 1.8A+5.0V = 1.8A):84.30% USB-C1+USB-C2+USB-A1: (20.0V = 2.25A+20.0V = 1.5A+12.0V = 1.5A):81.36% Единичен порт: USB-C1: 20.0V = 5.0A:80.82% USB-C1: 21.0V = 4.76A:85.28%
Консумация на енергия без товар	0.094W

Горната информация може да бъде намерена на уебсайта на вносителя www.targus.com

HR Uvod

Ovaj zidni punjač s GaN tehnologijom i izmjenjivim utikačima za međunarodnu upotrebu omogućuje istovremeno punjenje prijenosnih računala, tablet računala, pametnih telefona i drugih USB uređaja različitih proizvođača, uključujući Apple, Dell, Google, Lenovo, Samsung i ostale.

Sadržaj

- Targus GaN AC adapter za putovanje 100 W
- US, EU, UK, AU - AC utikač
- Korisnički priručnik

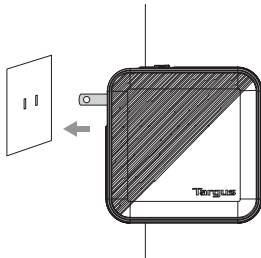
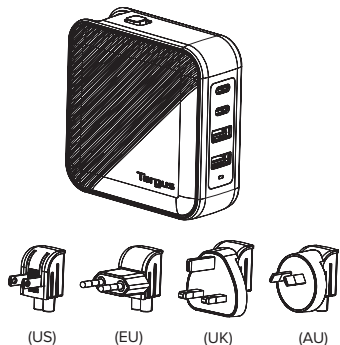
**OPREZI!**

Pogledajte sliku za zidnu opciju. Držati izvan dohvata djece.

Podaci o električnoj energiji

Ulaz: 100 - 240VAC 1.8A MAKS 50/60Hz

Izlaz:

Pojedinačni priključak:

USB-C1/C2 PD: 5.0V/9.0V/12.0V/15.0V = 3.0A, 20.0V = 5.0A

USB-C1/C2: PPS 3.30-21.0V = 5.0A 100.0W MAKS

USB-A1/A2 QC3.0: 5.0V = 3.0A, 9.0V = 2.0A, 12.0V = 1.5A, 18.0W MAKS

Višestruki priključak:

USB-C1+USB-C2: 65.0W+30.0W

USB-C1+USB-C2+USB-A1/A2: 45.0W+30.0W+18.0W (QC3.0)

USB-C1/C2+USB-A1+USB-A2: 65.0W+18.0W (NO QC3.0)

USB-C1+USB-C2+USB-A1+USB-A2: 45.0W+30.0W+18.0W (NO QC3.0)

Ukupno: 100,0 W MAKS

Rad

Značajka	Zahtjevi
Radna temperatura:	0 °C do 35 °C
Temperatura skladištenja	-20 °C do 85 °C
Relativna vlažnost	20% do 80%, bez kondenzacije
Vlažnost pri skladištenju	5% do 95%, bez kondenzacije
Dugotrajna nadmorska visina	Manje od 5000 m
Nadmorska visina za skladištenje	Manje od 15000 m

VAŽNE UPUTE ZA ZAMJENU IZMJENJIVIH AC UTIKAČA

Postupci:

1. Prije upotrebe provjerite upotrebljavate li odgovarajući izmjenjivi AC utikač.

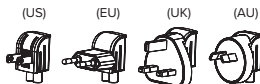

2. Kada mijenjate izmjenjivi AC utikač (američki AC utikač kao primjer za ilustraciju postupka) najprije gurnite gornju polugicu prema naprijed i uklonite ga.

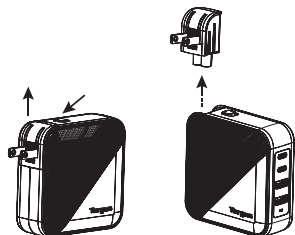

3. Gurnite odgovarajući izmjenjivi AC utikač za zemlju u kojoj boravite.

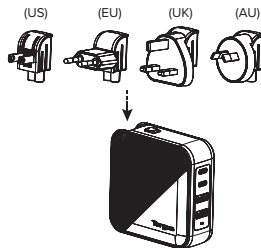

PRIJE UPOTREBE PROČITAJTE SVE UPUTE.

VAŽNE SIGURNOSNE NAPOMENE

Sigurnosne mjere opreza

1. Uvijek provjerite je li nazivni ulazni napon zidnog punjača kompatibilan s utičnicom koju namjeravate upotrebljavati.
2. Zidni punjač treba biti potpuno utaknut u utičnicu. Zidni punjač nemojte nikada upotrebljavati ako su pin ili jezičac izloženi.
3. Prije uključivanja u utičnicu provjerite je li izmjenjivi AC utikač odgovarajući za zemlju u kojoj boravite.
4. Nemojte nikada doticati metalne dijelove punjača kada ga upotrebljavate.
5. Proizvod je predviđen samo za upotrebu u zatvorenim prostorima.
6. Ako je metalni pin AC utikača deformiran ili labav, prestanite ga upotrebljavati.

Ako su priključena oba USB-A priključka, funkcija QC3.0 bit će onemogućena.

Izlazni pojedinačni priključak:

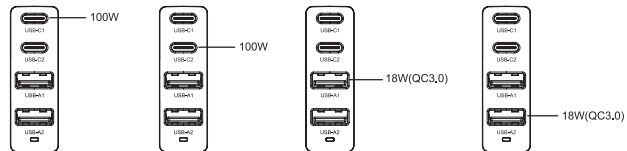

Izlazna dva priključka:

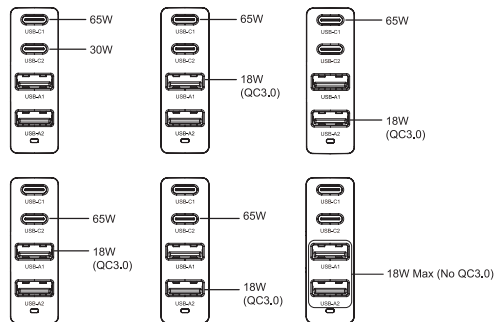

Izlazna tri priključka:

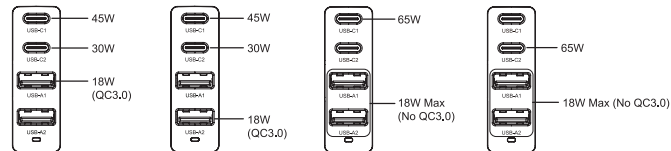

Izlazni svi priključci:

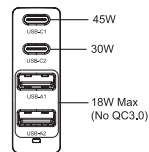

Informacije o vanjskom strujnom napajanju

Proizvođač	Targus International LLC
Adresa	1211 North Miller Street, Anaheim, CA 92806 USA
Trgovački registarski broj	5892659
Model/reg.	APA109
Ulazni napon	100 - 240 V~
Ulazna AC frekvencija	50/60 Hz
Izlazni napon	Pojedinačni priključak: USB-C1/C2 PD: 5,0 V/9,0 V/12,0 V/15,0 V = 3,0 A, 20,0 V = 5,0 A USB-C1/C2: PPS 3,30 - 21,0 V = 5,0 A 100,0 W MAKS. USB-A1/A2 QC3.0: 5,0 V = 3,0 A, 9,0 V = 2,0 A, 12,0 V = 1,5 A, 18,0 W MAKS
Izlazna struja	Višestruki priključak: USB-C1+USB-C2: 65,0 W + 30,0 W USB-C1+USB-C2+USB-A1/A2: 45,0 W + 30,0 W + 18,0 W (QC3.0) USB-C1/USB-C2+USB-A1+USB-A2: 65,0W + 18,0 W (NO QC3.0) USB-C1+USB-C2+USB-A1+USB-A2: 45,0 W + 30,0 W + 18,0 W (NO QC3.0)
Izlazna snaga	100,0 W MAKS

Prosječna aktivna učinkovitost	Višestruki priključak: USB-C1+USB-C2+USB-A1+USB-A2: (5,0 V = 3,0 A + 5,0 V = 3,0 A + 5,0 V = 1,8 A + 5,0 V = 1,8 A):87,38% USB-C1+USB-C2+USB-A1: (20,0 V = 2,25 A + 20,0 V = 1,5 A + 12,0 V = 1,5 A):88,92% Pojedinačni priključak: USB-C1: 20,0 V = 5,0 A:90,16% USB-C1: 21,0V = 4,76A:90,33%
Učinkovitost pri malom opterećenju (10%)	Višestruki priključak: USB-C1+USB-C2+USB-A1+USB-A2: (5,0 V = 3,0 A + 5,0 V = 3,0 A + 5,0 V = 1,8 A + 5,0 V = 1,8 A):84,30% USB-C1+USB-C2+USB-A1: (20,0 V = 2,25 A + 20,0 V = 1,5 A + 12,0 V = 1,5 A):81,36% Pojedinačni priključak: USB-C1: 20,0 V = 5,0 A:80,82% USB-C1: 21,0 V = 4,76 A:85,28%
Potrošnja struje bez opterećenja	0.094W

Prethodno navedene informacije možete pronaći na internetskoj stranici uvoznika www.targus.com

HU Bevezetés

Ez a GaN technológiát alkalmazó fali töltő és a nemzetközi használatra alkalmas, cserélhető csatlakozók laptopok, táblagépek, okostelefonok és egyéb USB tápellátású, különféle márkájú – ideértve Apple, Dell, Google, Lenovo, Samsung és más – eszközök egyidejű töltését teszik lehetővé.

Tartalom

- Targus 100 W GaN AC úti adapter
- US, EU, UK, AU – AC csatlakozódugó
- Használati útmutató

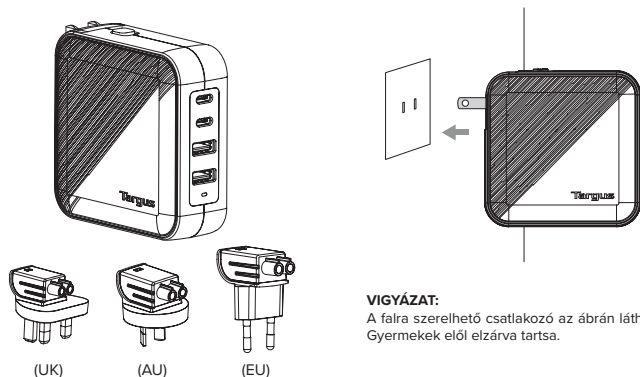
**VIGYÁZAT:**

A falra szerelhető csatlakozó az ábrán látható. Gyermekek elől elzárva tartsa.

Elektromos kapacitás

Bemenet: 100 - 240VAC 1.8A MAX 50/60Hz

Kimenet:

Külön port:

USB-C1/C2 PD: 5.0V/9.0V/12.0V/15.0V = 3.0A, 20.0V = 5.0A

USB-C1/C2: PPS 3.30-21.0V = 5.0A 100.0W MAX

USB-A1/A2 QC3.0: 5.0V = 3.0A, 9.0V = 2.0A, 12.0V = 1.5A, 18.0W MAX

Több port:

USB-C1+USB-C2: 65.0W+30.0W

USB-C1+USB-C2+USB-A1/A2: 45.0W+30.0W+18.0W (QC3.0)

USB-C1/C2+USB-A1+USB-A2: 65.0W+18.0W (NO QC3.0)

USB-C1+USB-C2+USB-A1+USB-A2: 45.0W+30.0W+18.0W (NO QC3.0)

Összesen: 100,0 W MAX.

Működtetés

Tétel	Követelmények
Működési hőmérséklet	0 °C és 35 °C között
Tárolási hőmérséklet	-20 °C és 85 °C között
Relatív páratartalom	20% és 80% között, nem kondenzálódó
Tárolási páratartalom	5% és 95% között, nem kondenzálódó
Tengerszint feletti magasság hosszú ideig	5000 m-nél alacsonyabb
Tárolási magasság	15 000 m-nél alacsonyabb

A CSERÉLHETŐ AC CSATLAKOZÓK CSERÉJÉRE VONATKOZÓ FONTOS UTASÍTÁSOK

Folyamat:

1. Használat előtt ellenőrizze a megfelelő cserélhető AC hálózati csatlakozót.

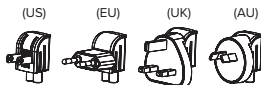

2. A cserélhető AC csatlakozó (US AC csatlakozó példaként a folyamat szemléltetéséhez) cseréjekor először csúsztassa előre a felső kart, majd vegye le.

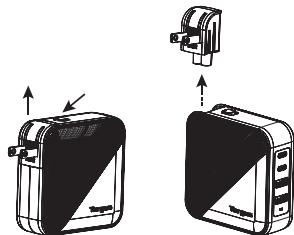

3. Csúsztassa be a tartózkodási hely szerinti országnak megfelelő cserélhető hálózati csatlakozót.

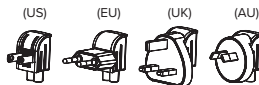

HASZNÁLAT ELŐTT OLVASSA EL AZ ÖSSZES UTASÍTÁST FONTOS BIZTONSÁGI ELŐÍRÁSOK

Biztonsági óvintézkedések

1. Mindig ügyeljen arra, hogy a fali töltő névleges bemeneti feszültsége kompatibilis legyen a használandó aljzattal.
2. A fali töltőt teljesen be kell dugni a hálózati aljzatba. Soha ne használja a fali töltőt, ha a csap vagy az érintkezőkés szabadon áll.
3. A fali aljzathoz való csatlakoztatás előtt ellenőrizze, hogy a cserélhető AC csatlakozó megfelel-e annak az országnak, ahol Ön tartózkodik.
4. Használat közben soha ne érjen a fali töltő fém részeihez.
5. A termék csak beltéri használatra készült.
6. Ha az AC csatlakozódugó fém csapja deformálódik vagy meglazul, akkor ne használja tovább.

Ha mindkét USB-A port csatlakoztatva van, a QC3,0 funkció ki van kapcsolva

Külön kimeneti port:

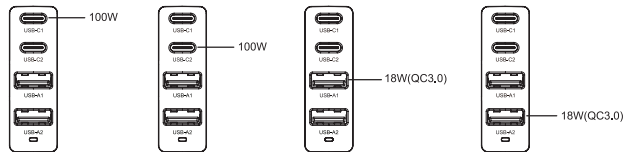

Kettős kimeneti port:

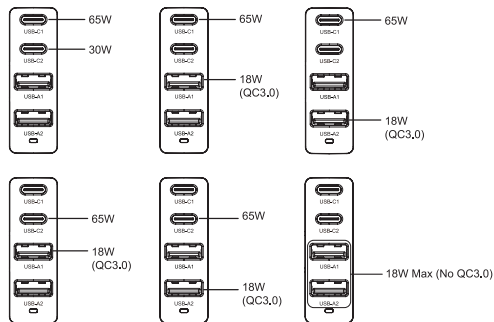

Három kimeneti port:

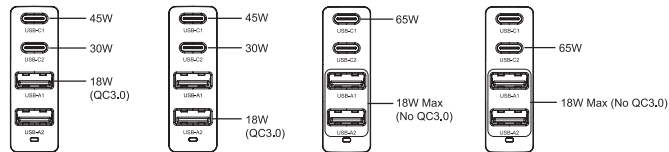

Az összes kimeneti port:

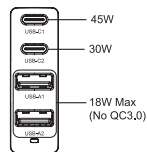

Külső tápellátással kapcsolatos információk

Gyártó	Targus International LLC
Cím	1211 North Miller Street, Anaheim, CA 92806 USA
Kereskedelmi Nyilvántartási szám	5892659
Modell/reg.	APA109
Bemeneti feszültség	100-240 V [~]
Bemeneti AC frekvencia	50/60 Hz
Feszültségkimenet	Külön port: USB-C1/C2 PD: 5,0 V/9,0 V/12,0 V/15,0 V = 3,0 A, 20,0 V = 5,0 A USB-C1/C2: PPS 3,30-21,0 V = 5,0 A 100,0 W MAX USB-A1/A2 QC3.0: 5,0 V = 3,0 A, 9,0 V = 2,0 A, 12,0 V = 1,5 A, 18,0 W MAX.
Kimenő feszültség	Több port: USB-C1+USB-C2: 65.0W+30.0W USB-C1+USB-C2+USB-A1/A2: 45.0W+30.0W+18.0W (QC3.0) USB-C1/USB-C2+USB-A1+USB-A2: 65,0 W+18,0 W (NO QC3.0) USB-C1+USB-C2+USB-A1+USB-A2: 45,0 W+30,0 W+18,0 W (NO QC3.0)
Teljesítmény	100.0W MAX

Átlagos aktív hatékonyság	Több port: USB-C1+USB-C2+USB-A1+USB-A2: (5,0 V = 3,0 A+5,0 V = 3,0 A+5,0 V = 1,8 A+5,0 V = 1,8 A): 87,38% USB-C1+USB-C2+USB-A1: (20,0 V = 2,25 A+20,0 V = 1,5 A+12,0 V = 1,5 A): 88,92% Külön port: USB-C1: 20,0 V = 5,0 A: 90,16% USB-C1: 21,0 V = 4,76 A: 90,33%
Hatékonyság alacsony terhelésnél (10%)	Több port: USB-C1+USB-C2+USB-A1+USB-A2: (5,0 V = 3,0 A+5,0 V = 3,0 A+5,0 V = 1,8 A+5,0 V = 1,8 A): 84,30% USB-C1+USB-C2+USB-A1: (20,0 V = 2,25 A+20,0 V = 1,5 A+12,0 V = 1,5 A): 81,36% Külön port: USB-C1: 20,0 V = 5,0 A: 80,82% USB-C1: 21,0 V = 4,76 A: 85,28%
Energiafogyasztás üresjáraton	0.094W

A fenti információk az importőr honlapján találhatóak: www.targus.com

LT Įvadas

Šis sieninis įkroviklis su GaN technologija ir keičiamaisiais tarptautinio naudojimo kištukais leidžia vienu metu įkrauti kelis nešiojamuosius kompiuterius, planšetinius kompiuterius, išmaniuosius telefonus ir kitus įvairių prekės ženklų USB maitinamus įrenginius: „Apple“, „Dell“, „Google“, „Lenovo“, „Samsung“ ir kitus.

Turinys

- „Targus“ 100 W GaN kintamosios srovės kelioninis adapteris
- JAV, ES, JK, AU kintamosios srovės kištukas
- Naudotojo vadovas

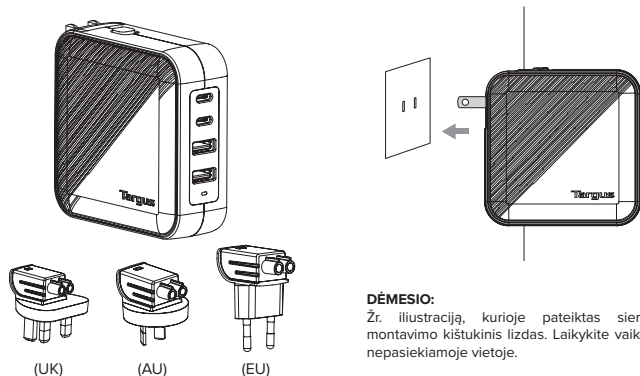
**Elektros charakteristikos**

Įvestis 100 - 240VAC 1.8A MAX 50/60Hz

Išvestis

Vienas prievadas:

USB-C1/C2 PD: 5.0V/9.0V/12.0V/15.0V = 3.0A, 20.0V = 5.0A

USB-C1/C2: PPS 3.30-21.0V = 5.0A 100.0W MAX

USB-A1/A2 QC3.0: 5.0V = 3.0A, 9.0V = 2.0A, 12.0V = 1.5A, 18.0W MAX

Keli prievadai:

USB-C1+USB-C2: 65.0W+30.0W

USB-C1+USB-C2+USB-A1/A2: 45.0W+30.0W+18.0W (QC3.0)

USB-C1/C2+USB-A1+USB-A2: 65.0W+18.0W (NO QC3.0)

USB-C1+USB-C2+USB-A1+USB-A2: 45.0W+30.0W+18.0W (NO QC3.0)

Iš viso: 100,0 W MAX

Veikimas

Gaminy	Reikalavimai
Darbinė temperatūra	0–35 °C
Laikymo temperatūra	-20–85 °C
Santykinė oro drėgmė	20–80 %, be kondensato
Laikymo drėgmė	5–95 %, be kondensato
Ilgalaikis aukštis	Mažiau nei 5 000 m
Laikymo aukštis	Mažiau nei 15 000 m

SVARBIOS KEIČIAMŲJŲ KINTAMOSIOS SROVĖS KIŠTUKŲ KEITIMO INSTRUKCIJOS

Procedūros:

1. Prieš naudodami patikrinkite, ar tinkamas keičiamasis kintamosios srovės kištukas.

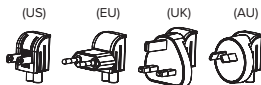

2. Keisdami keičiamąjį kintamosios srovės kištuką (JAV kintamosios srovės kištukas pateiktas kaip pavyzdys procedūroms iliustruoti), pirmiausia pastumkite viršutinę svirtį į priekį ir ją nuimkite.

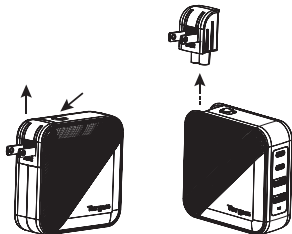

3. Šalyje, kurioje esate, naudokite tinkamą keičiamąjį kintamosios srovės kištuką.

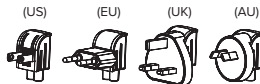

PRIŠ NAUDODAMI PERSKAITYKITE VISAS INSTRUKCIJAS.

SVARBŪS SAUGOS NURODYMAI

Atsargumo priemonės

1. Visada įsitinkite, kad sieninio įkroviklio vardinė įvestis įtampa atitinka ketinamo naudoti lizdo vardinę įvesties įtampą.
2. Sieninis įkroviklis turi būti iki galo įkištas į elektros lizdą. Niekada nenaudokite sieninio įkroviklio, jei kaištis arba mentė yra atviri.
3. Prieš jungdami į kištukinį lizdą įsitinkite, kad keičiamasis kintamosios srovės kištukas tinkamas naudoti šalyje, kurioje esate.
4. Niekada nelieskite jokių metalinių sieninio įkroviklio dalių, kai jis naudojamas.
5. Gaminys skirtas naudoti tik patalpose.
6. Jei kintamosios srovės kištuko metalinis kaištis deformuojasi arba atsilaisvina, nebenaudokite.

Jei prijungti abu USB-A prievadai, QC3.0 funkcija bus išjungta.

Išvesties vienas prievadas:

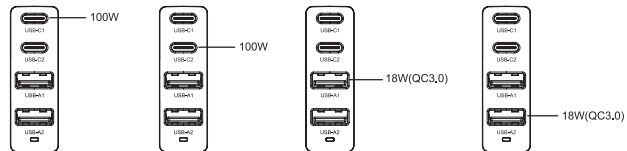

Išvesties du prievadai:

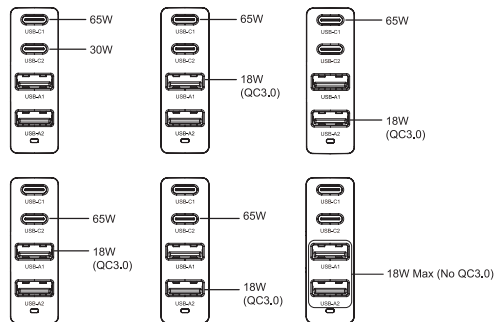

Išvesties trys prievadai:

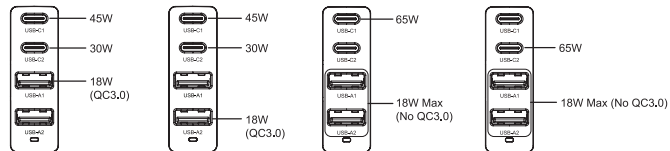

Išvesties visi prievadai:

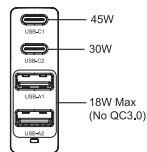

Informacija apie išorinį maitinimo šaltinį

Gamintojas	Targus International LLC
Adresas	1211 North Miller Street, Anaheim, CA 92806 USA
Komerčinis Registracijos numeris	5892659
Modelis / Reg.	APA 109
Įvesties įtampa	100–240 V [~]
Įvesties kintamosios srovės dažnis	50/60 Hz
Išvesties įtampa	Vienas prievadas: USB-C1/C2 PD: 5.0 V/9.0 V/12.0 V/15.0 V = 3.0 A, 20.0 V = 5.0 A USB-C1/C2: PPS 3.30-21.0 V = 5.0 A 100.0W MAX USB-A1/A2 QC3.0: 5.0 V = 3.0 A 9.0 V = 2.0 A 12.0 V = 1.5 A 18.0 W MAX
Išvesties srovė	Keli prievadai: USB-C1+USB-C2: 65.0 W+30.0 W USB-C1+USB-C2+USB-A1/A2: 45.0 W+30.0 W+18.0 W (QC3.0) USB-C1/USB-C2+USB-A1+USB-A2: 65.0W+18.0W (NO QC3.0) USB-C1+USB-C2+USB-A1+USB-A2: 45.0 W+30.0 W+18.0 W (NO QC3.0)
Išvesties galia	100.0 W MAX

Vidutinis aktyvusis efektyvumas	Keli prievadai: USB-C1+USB-C2+USB-A1+USB-A2: (5.0 V = 3.0 A+5.0 V = 3.0 A+5.0 V = 1.8 A+5.0 V = 1.8 A):87.38 % USB-C1+USB-C2+USB-A1: (20.0 V = 2.25 A+20.0 V = 1.5 A+12.0 V = 1.5 A):88.92 % Vienas prievadas: USB-C1: 20.0 V = 5.0 A:90.16 % USB-C1: 21.0 V = 4.76 A:90.33 %
Efektyvumas esant mažai apkrovai (10 %)	Keli prievadai: USB-C1+USB-C2+USB-A1+USB-A2: (5.0 V = 3.0 A+5.0 V = 3.0 A+5.0 V = 1.8 A+5.0 V = 1.8 A):84.30 % USB-C1+USB-C2+USB-A1: (20.0 V = 2.25 A+20.0 V = 1.5 A+12.0 V = 1.5 A):81.36 % Vienas prievadas: USB-C1: 20.0 V = 5.0 A:80.82 % USB-C1: 21.0 V = 4.76 A:85.28 %
Energijos sąnaudos be apkrovos	0.094W

Minėtą informaciją galima rasti importuotojo svetainėje www.targus.com.

RO Introducere

Acest încărcător de rețea cu tehnologie GaN și mufe interschimbabile pentru utilizare internațională permite încărcarea simultană a mai multor dispozitive, precum laptopuri, tablete, smartphone-uri și alte dispozitive alimentate prin USB de la diferite branduri, inclusiv Apple, Dell, Google, Lenovo, Samsung și altele.

Conținut

- Adaptor de voiaj cu c.a. Targus 100W GaN
- Ștecher de c.a. SUA, UE, UK, AU
- Ghid de utilizare

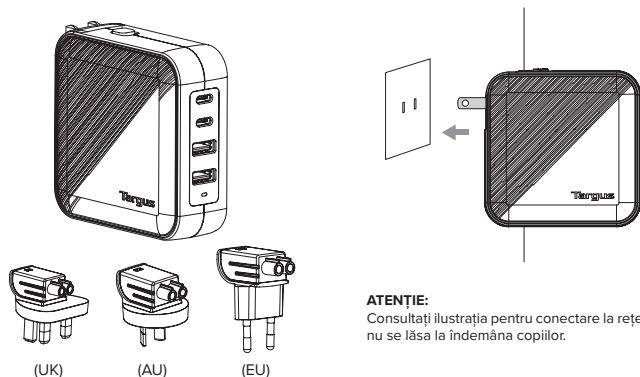
**ATENȚIE:**

Consultați ilustrația pentru conectare la rețea. A nu se lăsa la îndemâna copiilor.

Clasificare electrică

Intrare: 100 - 240VAC 1.8A MAX 50/60Hz

leșire:

Port unic:

USB-C1/C2 PD: 5.0V/9.0V/12.0V/15.0V = 3.0A, 20.0V = 5.0A

USB-C1/C2: PPS 3.30-21.0V = 5.0A 100.0W MAX

USB-A1/A2 QC3.0: 5.0V = 3.0A, 9.0V = 2.0A, 12.0V = 1.5A, 18.0W MAX

Port multiplu:

USB-C1+USB-C2: 65.0W+30.0W

USB-C1+USB-C2+USB-A1/A2: 45.0W+30.0W+18.0W (QC3.0)

USB-C1/C2+USB-A1+USB-A2: 65.0W+18.0W (NO QC3.0)

USB-C1+USB-C2+USB-A1+USB-A2: 45.0W+30.0W+18.0W (NO QC3.0)

Total: 100,0W MAX

Funcționare

Articol	Cerințe
Temperatură de funcționare	0° până la 35°C
Temperatură de depozitare	-20° până la 85°C
Umiditate relativă	20% până la 80%, fără condens
Umiditate de depozitare	5% până la 95%, fără condens
Altitudine pe termen lung	Sub 5000 m
Altitudine de depozitare	Sub 15000 m

INSTRUCȚIUNI IMPORTANTE PENTRU SCHIMBAREA ȘTECHERELOR DE C.A. INTERSCHIMBABILE

Proceduri:

1. Confirmați ștecherul de c.a. interschimbabil corespunzător înainte de utilizare.

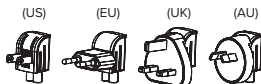

2. Când schimbați ștecherul de c.a. interschimbabil (ștecherul de c.a. SUA ca exemplu pentru a ilustra procedurile), glisați mai întâi pârghia superioară înainte și scoateți-o.

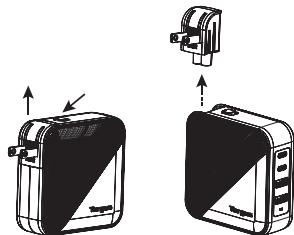

3. Introduceți ștecherul de c.a. interschimbabil adecvat pentru țara în care vă aflați.

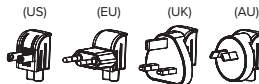

CITIȚI TOATE INSTRUCȚIUNILE ÎNAINTE DE UTILIZARE

INSTRUCȚIUNI DE SIGURANȚĂ IMPORTANTE

Măsuri de siguranță

1. Asigurați-vă întotdeauna că tensiunea nominală de intrare a încărcătorului de rețea este compatibilă cu priza pe care intenționați să o utilizați.
2. Încărcătorul de rețea trebuie introdus complet în priză. Nu utilizați niciodată încărcătorul de rețea dacă pinul sau lama sunt expuse.
3. Confirmați că ștecherul interschimbabil de c.a. este potrivit pentru țara în care vă aflați, înainte de a conecta la priză.
4. Nu atingeți niciodată nicio parte metalică a încărcătorului de rețea atunci când este utilizat.
5. Produsul este conceput numai pentru utilizare în interior.
6. Dacă pinul metalic al ștecherului de curent alternativ se deformează sau este desfăcut, întrerupeți utilizarea acestuia.

Dacă ambele porturi USB-A sunt conectate, caracteristica QC3.0 va fi dezactivată

Port unic de ieșire:

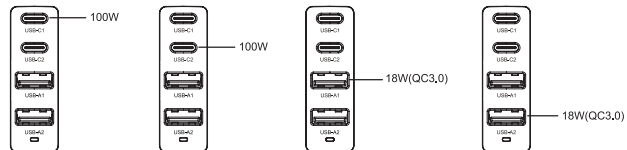

Porturi duble de ieșire:

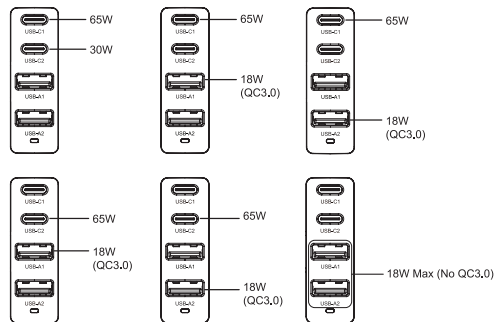

Porturi triple de ieșire:

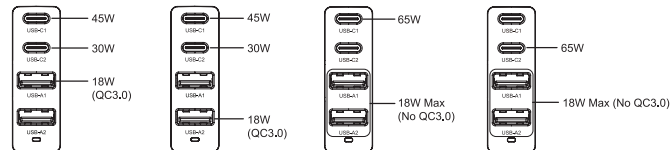

Toate porturile de ieșire:

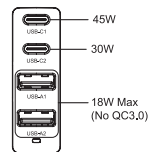

Informații despre sursa de alimentare externă

Producător	Targus International LLC
Adresa	1211 North Miller Street, Anaheim, CA 92806 SUA
Comercial Număr de înregistrare	5892659
Model/Înreg	APA109
Tensiune de intrare	100-240V~
Frecvența c.a. de intrare	50/60Hz
Tensiune de ieșire	Port unic: USB-C1/C2 PD: 5,0V/9,0V/12,0V/15,0V = 3,0A, 20,0V = 5,0A USB-C1/C2: PPS 3,30-21,0V = 5,0A 100,0W MAX USB-A1/A2 QC3.0: 5,0V = 3,0A, 9,0V = 2,0A, 12,0V = 1,5A, 18,0W MAX
Curent de ieșire	Port multiplu: USB-C1+USB-C2: 65,0W+30,0W USB-C1+USB-C2+USB-A1/A2: 45,0W+30,0W+18,0W (QC3.0) USB-C1/USB-C2+USB-A1+USB-A2: 65,0W+18,0W (NO QC3.0) USB-C1+USB-C2+USB-A1+USB-A2: 45,0W+30,0W+18,0W (NO QC3.0)
Putere de ieșire	100.0W MAX

Eficiență activă medie	Port multiplu: USB-C1+USB-C2+USB-A1+USB-A2: (5,0V = 3,0A+5,0V = 3,0A+5,0V = 1,8A+5,0V = 1,8A):87,38% USB-C1+USB-C2+USB-A1: (20,0V = 2,25A+20,0V = 1,5A+12,0V = 1,5A):88,92% Port unic: USB-C1: 20,0V = 5,0A:90,16% USB-C1: 21,0V = 4,76A:90,33%
Eficiență la sarcină mică (10%)	Port multiplu: USB-C1+USB-C2+USB-A1+USB-A2: (5,0V = 3,0A+5,0V = 3,0A+5,0V = 1,8A+5,0V = 1,8A):84,30% USB-C1+USB-C2+USB-A1: (20,0V = 2,25A+20,0V = 1,5A+12,0V = 1,5A):81,36% Port unic: USB-C1: 20,0V = 5,0A:80,82% USB-C1: 21,0V = 4,76A:85,28%
Consum de energie în gol	0.094W

Informațiile de mai sus pot fi găsite pe site-ul web al importatorului www.targus.com

SK Úvod

Táto nástenná nabíjačka s technológiou GaN a zameniteľnými zástrčkami na medzinárodné použitie umožňuje súčasné nabíjanie viacerých zariadení notebookov, tabletov, smartfónov a iných zariadení napájaných cez USB od rôznych značiek vrátane Apple, Dell, Google, Lenovo, Samsung a ďalších.

Obsah

- Cestovný adaptér Targus 100W GaN AC
- USA, EÚ, Veľká Británia, Austrália – Striedavá zástrčka
- Návod na používanie

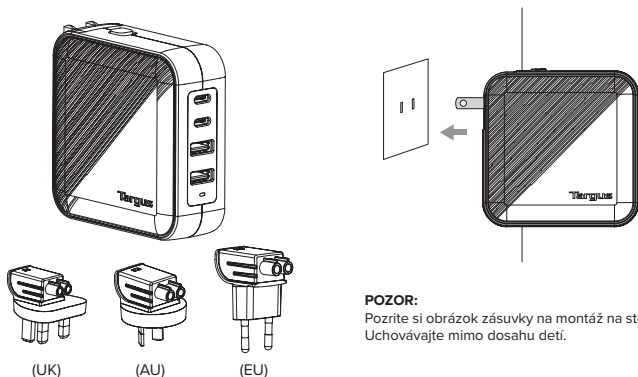
**Elektrická trieda**

Vstup: 100 - 240VAC 1.8A MAX 50/60Hz

Výstup:

Samostatný port:

USB-C1/C2 PD: 5.0V/9.0V/12.0V/15.0V = 3.0A, 20.0V = 5.0A

USB-C1/C2: PPS 3.30-21.0V = 5.0A 100.0W MAX

USB-A1/A2 QC3.0: 5.0V = 3.0A, 9.0V = 2.0A, 12.0V = 1.5A, 18.0W MAX

Multi port:

USB-C1+USB-C2: 65.0W+30.0W

USB-C1+USB-C2+USB-A1/A2: 45.0W+30.0W+18.0W (QC3.0)

USB-C1/C2+USB-A1+USB-A2: 65.0W+18.0W (NO QC3.0)

USB-C1+USB-C2+USB-A1+USB-A2: 45.0W+30.0W+18.0W (NO QC3.0)

Celkom: 100,0 W MAX

Prevádzka

Položka	Požiadavky
Prevádzková teplota	0 °C až 35 °C
Teplota skladovania	-20 °C až 85 °C
Relatívna vlhkosť	20 % až 80 %, bez kondenzácie
Skladovacia vlhkosť	5 % až 95 %, bez kondenzácie
Dlhodobá nadmorská výška	Menej ako 5 000 m
Nadmorská výška skladovania	Menej ako 15 000 m

DÔLEŽITÉ POKYNY NA VÝMENU ZAMENITELNÝCH STRIEDAVÝCH ZÁSTRČIEK

Postupy:

1. Pred použitím si overte vhodnú zameniteľnú striedavú zástrčku.

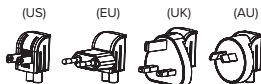

2. Pri výmene zameniteľnej striedavej zástrčky (US striedavá zástrčka ako príklad na ilustráciu postupov) posuňte najprv hornú páčku dopredu a vyberte ju.

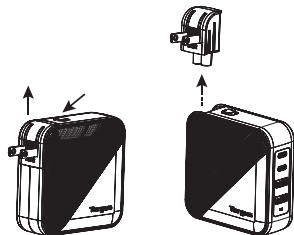

3. Zasuňte príslušnú zameniteľnú striedavú zástrčku pre krajinu, v ktorej sa nachádzate.

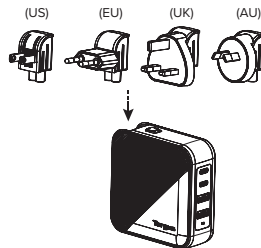

PRED POUŽITÍM SI PREČÍTAJTE VŠETKY POKYNY

DÔLEŽITÉ BEZPEČNOSTNÉ POKYNY

Bezpečnostné opatrenia

1. Vždy sa uistite, že menovité vstupné napätie nástennej nabíjačky je kompatibilné so zásuvkou, ktorú chcete použiť.
2. Nástenná nabíjačka musí byť úplne zasunutá do zásuvky. Nikdy nepoužívajte nástennú nabíjačku, ak je kolík alebo čepeľ odkrytá.
3. Pred zapojením do zásuvky skontrolujte, či je zameniteľná striedavá zástrčka vhodná pre krajinu, v ktorej sa nachádzate.
4. Počas používania sa nikdy nedotýkajte žiadnej kovovej časti nástennej nabíjačky.
5. Výrobok je určený len na použitie v interiéri.
6. Ak sa kovový kolík zástrčky striedavého prúdu zdeformuje alebo uvoľní, prestaňte zástrčku používať.

Ak sú pripojené oba porty USB-A, funkcia QC3.0 bude vypnutá

Výstupný samostatný port:

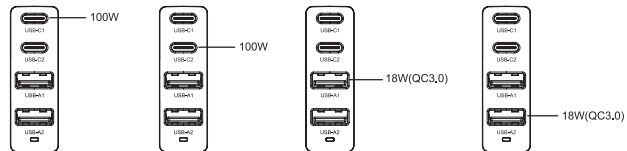

Výstupné duálne porty:

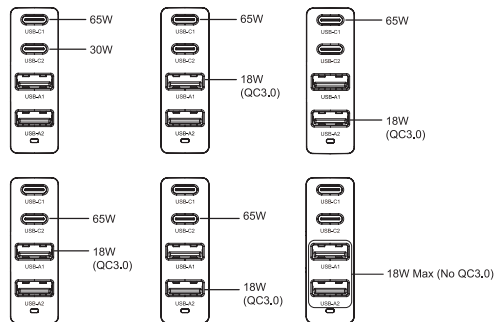

Tri výstupné porty:

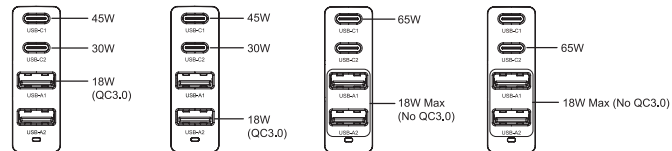

Všetky výstupné porty:

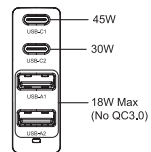

Informácie o externom napájaní

Výrobca	Targus International LLC
Adresa	1211 North Miller Street, Anaheim, CA 92806 USA
Komerčné registračné číslo:	5892659
Model/reg.	APA109
Vstupné napätie	100 – 240 V [~]
Vstupná AC frekvencia	50/60 Hz
Výstupné napätie	Samostatný port: USB-C1/C2 PD: 5,0 V/9,0 V/12,0 V/15,0 V = 3,0 A, 20,0 V = 5,0 A USB-C1/C2: PPS 3,30 – 21,0 V = 5,0 A 100,0 W MAX USB-A1/A2 QC3.0: 5,0 V = 3,0 A, 9,0 V = 2,0 A, 12,0 V = 1,5 A, 18,0 W MAX
Výstupný prúd	Multi port: USB-C1 + USB-C2: 65,0 W + 30,0 W USB-C1 + USB-C2 + USB-A1/A2: 45,0 W + 30,0 W + 18,0 W (QC3.0) USB-C1/USB-C2 + USB-A1 + USB-A2: 65,0 W + 18,0 W (BEZ QC3.0) USB-C1 + USB-C2 + USB-A1 + USB-A2: 45,0 W + 30,0 W + 18,0 W (BEZ QC3.0)
Výstupný výkon	100.0W MAX

Priemerná aktívna účinnosť	Multi port: USB-C1 + USB-C2 + USB-A1 + USB-A2: (5,0 V = 3,0 A + 5,0 V = 3,0 A + 5,0 V = 1,8 A + 5,0 V = 1,8 A): 87,38 % USB-C1 + USB-C2 + USB-A1: (20,0 V = 2,25 A + 20,0 V = 1,5 A + 12,0 V = 1,5 A): 88,92 % Samostatný port: USB 1.1/2.0: 20,0 V = 5,0 A: 90,16 % USB 1.1/2.0: 21,0 V = 4,76 A: 90,33 %
Účinnosť pri nízkom zaťažení (10 %)	Multi port: USB-C1 + USB-C2 + USB-A1 + USB-A2: (5,0 V = 3,0 A + 5,0 V = 3,0 A + 5,0 V = 1,8 A + 5,0 V = 1,8 A): 84,30 % USB-C1 + USB-C2 + USB-A1: (20,0 V = 2,25 A + 20,0 V = 1,5 A + 12,0 V = 1,5 A): 81,36 % Samostatný port: USB 1.1/2.0: 20,0 V = 5,0 A: 80,82 % USB 1.1/2.0: 21,0 V = 4,76 A: 85,28 %
Spotreba energie bez zaťaženia	0.094W

Uvedené informácie nájdete na webovej stránke dovozcu www.targus.com

SL Uvod

Ta stenski polnilnik s tehnologijo GaN in zamenljivimi vtiči za mednarodno uporabo omogoča istočasno polnjenje več naprav, kot so prenosni računalniki, tablice, pametni telefoni in druge USB-naprave različnih blagovnih znamk, na primer Apple, Dell, Google, Lenovo, Samsung in drugih.

Vsebina

- 100-W potovalni adapter na izmenični tok Targus GaN
- Vtič za izmenični tok za ZDA, EU, UK, AU
- Uporabniški priročnik

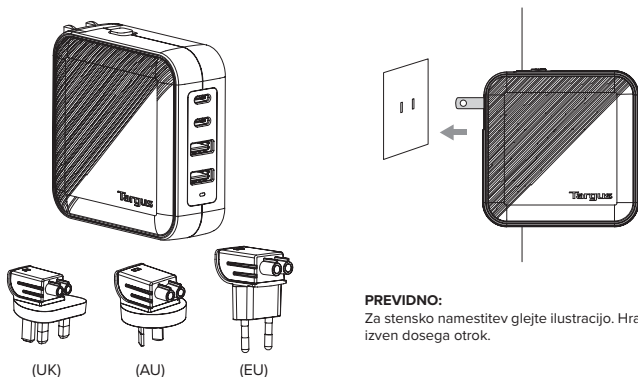
**PREVIDNO:**

Za stensko namestitev glejte ilustracijo. Hranite izven dosega otrok.

Nazivne vrednosti glede elektrike

Vhodna moč: 100 - 240VAC 1.8A MAX 50/60Hz

Izhodna moč:

Ena vrata:

USB-C1/C2 PD: 5.0V/9.0V/12.0V/15.0V = 3.0A, 20.0V = 5.0A

USB-C1/C2: PPS 3.30-21.0V = 5.0A 100.0W MAX

USB-A1/A2 QC3.0: 5.0V = 3.0A, 9.0V = 2.0A, 12.0V = 1.5A, 18.0W MAX

Več vrat:

USB-C1+USB-C2: 65.0W+30.0W

USB-C1+USB-C2+USB-A1/A2: 45.0W+30.0W+18.0W (QC3.0)

USB-C1/C2+USB-A1+USB-A2: 65.0W+18.0W (NO QC3.0)

USB-C1+USB-C2+USB-A1+USB-A2: 45.0W+30.0W+18.0W (NO QC3.0)

Skupaj: najv. 100,0 W

Delovanje

Element	Zahteve
Delovna temperatura	od 0 °C do 35 °C
Temperatura shranjevanja	od -20 °C do 85 °C
Relativna vlaga	od 20 % do 80 %, nekondenzirajoča
Vlaga pri shranjevanju	od 5 % do 95 %, nekondenzirajoča
Dolgoročna nadmorska višina	Manj kot 5000 m
Nadmorska višina shranjevanja	Manj kot 15.000 m

POMEMBNA NAVODILA ZA ZAMENJAVO ZAMENLJIVIH VTIČEV ZA IZMENIČNI TOK

Postopki:

1. Pred uporabo se prepričajte, da je zamenljivi vtič za izmenični tok ustrezen.

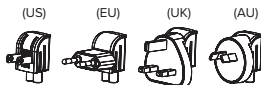

2. Pri menjavi zamenljivega vtiča za izmenični tok (primer ameriškega vtiča za izmenični tok za ponazoritev postopkov) najprej potisnite zgornji vzvod naprej in ga odstranite.

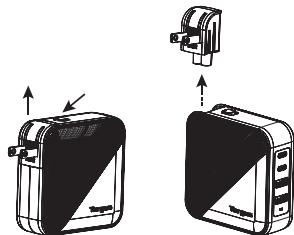

3. Vstavite ustrezen zamenljiv vtič za izmenični tok za državo, v kateri ste.

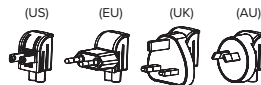

PRED UPORABO PREBERITE VSA NAVODILA

POMEMBNA VARNOSTNA NAVODILA

Varnostni ukrepi

1. Vedno se prepričajte, da je nazivna vhodna napetost stenskega polnilnika združljiva z vtičnico, ki jo nameravate uporabiti.
2. Stenski polnilnik mora biti do konca vstavljen v vtičnico. Nikoli ne uporabljajte stenskega polnilnika, če je nožica ali zatič brez zaščite.
3. Pred priključitvijo v vtičnico preverite, ali je izmenljivi vtič ustrezen za državo, v kateri se nahajate.
4. Med uporabo se nikoli ne dotikajte kovinskih delov stenskega polnilnika.
5. Izdelek je namenjen samo za uporabo v notranjih prostorih.
6. Če se kovinski zatič vtiča za izmenični tok deformira ali zrahlja, ga prenehajte uporabljati.

Če so oboja vrata USB-A priključena, je funkcija QC3.0 onemogočena.

Izhodna moč na enih vratih:

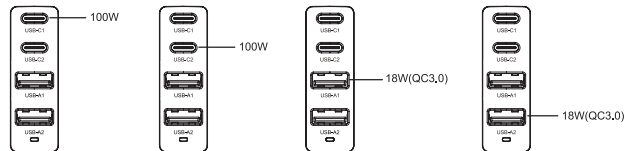

Izhodna moč na dvojnih vratih:

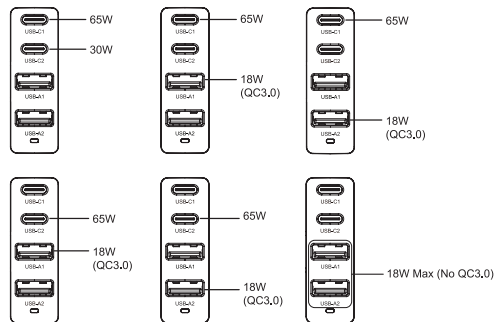

Izhodna moč na trojnih vratih:

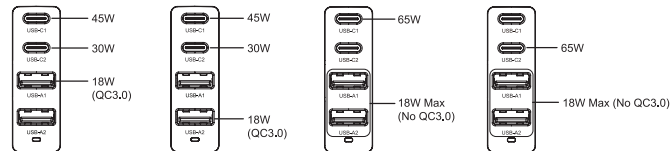

Izhodna moč na vseh vratih:

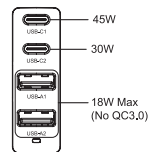

Podatki o zunanjem napajanju

Proizvajalec	Targus International LLC
Naslov	1211 North Miller Street, Anaheim, CA 92806 ZDA
Komercialna registracijska številka	5892659
Model/reg.	APA109
Vhodna napetost	100–240 V [~]
Vhodna izmenična frekvenca	50/60 Hz
Izhodna napetost	Ena vrata: USB-C1/C2 PD: 5,0 V/9,0 V/12,0 V/15,0 V = 3,0 A, 20,0 V = 5,0 A USB-C1/C2: PPS 3,30–21,0 V = 5,0 A 100,0 W NAJV. USB-A1/A2 QC3.0: 5,0 V = 3,0 A, 9,0 V = 2,0 A, 12,0 V = 1,5 A, 18,0 W NAJV.
Izhodni tok	Več vrat: USB-C1+USB-C2: 65,0 W + 30,0 W USB-C1 + USB-C2 + USB-A1/A2: 45,0 W + 30,0 W + 18,0 W (QC3.0) USB-C1/USB-C2 + USB-A1 + USB-A2: 65,0 W + 18,0 W (BREZ QC3.0) USB-C1 + USB-C2 + USB-A1 + USB-A2: 45,0 W + 30,0 W + 18,0 W (BREZ QC3.0)
Izhodna moč	100,0 W NAJV.

Povprečna aktivna učinkovitost	Več vrat: USB-C1 + USB-C2 + USB-A1 + USB-A2: (5,0 V = 3,0 A + 5,0 V = 3,0 A + 5,0 V = 1,8 A + 5,0 V = 1,8 A): 87,38 % USB-C1+USB-C2+USB-A1: (20,0 V = 2,25 A + 20,0 V = 1,5 A + 12,0 V = 1,5 A): 88,92 % Ena vrata: USB-C1: 20,0 V = 5,0 A: 90,16 % USB-C1: 21,0 V = 4,76 A: 90,33 %
Učinkovitost pri nizki obremenitvi (10 %)	Več vrat: USB-C1 + USB-C2 + USB-A1 + USB-A2: (5,0 V = 3,0 A + 5,0 V = 3,0 A + 5,0 V = 1,8 A + 5,0 V = 1,8 A): 84,30 % USB-C1+USB-C2+USB-A1: (20,0 V = 2,25 A + 20,0 V = 1,5 A + 12,0 V = 1,5 A): 81,36 % Ena vrata: USB-C1: 20,0 V = 5,0 A: 80,82 % USB-C1: 21,0 V = 4,76 A: 85,28 %
Poraba energije, kadar ni obremenitve	0.094W

Zgornje informacije so na voljo na spletni strani uvoznika www.targus.com.

LV Ievads

Ar šo sienas lādētāju, kas aprīkots ar GaN tehnoloģiju un apmaināmajiem spraudņiem starptautiskai izmantošanai, iespējams vienlaikus uzlādēt vairākas ierīces, tostarp klēpj datorus, planšetdatorus, viedtālruņus un citas USB barošanas ierīces no dažādiem zīmoliem, tostarp „Apple“, „Dell“, „Google“, „Lenovo“, „Samsung“ un citu zīmolu ierīcēm.

Saturs

- Targus 100W GaN maiņstrāvas ceļojumu adapteris
- ASV, ES, AK, AU — maiņstrāvas spraudnis
- Lietošanas pamācība

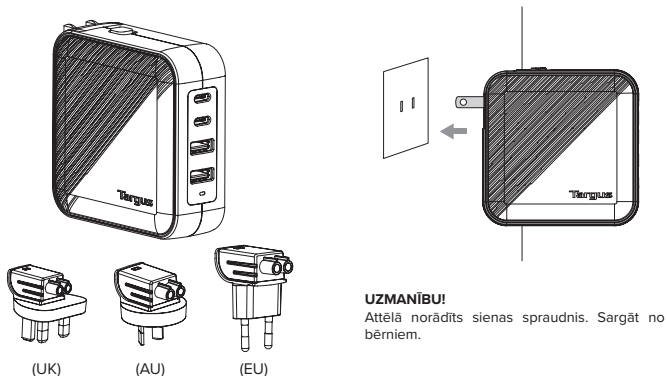
**Elektriskais spriegums un strāvas patēriņš**

Ievades jauda: 100 - 240VAC 1.8A MAX 50/60Hz

Izejas jauda:

Viens ports:

USB-C1/C2 PD: 5.0V/9.0V/12.0V/15.0V = 3.0A, 20.0V = 5.0A

USB-C1/C2: PPS 3.30-21.0V = 5.0A 100.0W MAX

USB-A1/A2 QC3.0: 5.0V = 3.0A, 9.0V = 2.0A, 12.0V = 1.5A, 18.0W MAX

Vairāki porti:

USB-C1+USB-C2: 65.0W+30.0W

USB-C1+USB-C2+USB-A1/A2: 45.0W+30.0W+18.0W (QC3.0)

USB-C1/C2+USB-A1+USB-A2: 65.0W+18.0W (NO QC3.0)

USB-C1+USB-C2+USB-A1+USB-A2: 45.0W+30.0W+18.0W (NO QC3.0)

Kopā: 1000 W MAKS.

Ekspluatācija

Vienība	Prasības
Darba temperatūra	no 0 līdz 35 °C
Uzglabāšanas temperatūra	-20 °C līdz 85 °C
Relatīvais mitrums	20 % līdz 80 %, bez kondensācijas
Uzglabāšanas mitrums	5 % līdz 95 %, bez kondensācijas
Augstumā ilgtermiņā	Zemāk par 5000 m
Uzglabāšanas augstums	Zemāk par 15000 m

SVARĪGI NORĀDĪJUMI PAR APMAINĀMO MAIŅSTRĀVAS SPRAUDŅU NOMAIŅU

Procedūra:

1. Pirms lietošanas pārbaudiet, vai tiks izmantots atbilstošs apmaināmais maiņstrāvas spraudnis.

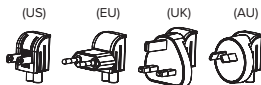

2. Pirms apmaināmā maiņstrāvas spraudņa nomaiņas (ASV maiņstrāvas spraudnis ir šīs procedūras piemērs), vispirms pabīdiet augšējo sviru virzienā uz priekšu un izņemiet laukā.

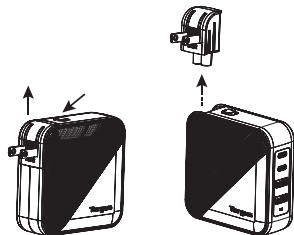

3. Iespraudiet apmaināmo maiņstrāvas spraudni, kurš ir derīgs lietošanai valstī, kurā atrodaties.

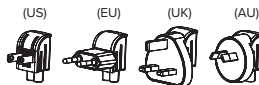

PIRMS LIETOŠANAS IZLASIET VISUS NORĀDĪJUMUS

SVARĪGI DROŠĪBAS NORĀDĪJUMI

Piesardzības pasākumi

1. Vienmēr pārļiecinieties, vai sienas lādētāja nominālais ieejas spriegums ir saderīgs ar kontaktligzdu, kuru izmantosit.
2. Sienas lādētājam jābūt iespraustam kontaktligzdā līdz galam. Nekad neizmantojiet sienas lādētāju, ja ir bojātas tapiņas vai asmens.
3. Pirms iespraušanas kontaktligzdā pārbaudiet, vai maināmais maiņstrāvas spraudnis ir piemērots lietošanai valstī, kurā atrodaties.
4. Nekad lietošanas laikā nepieskarieties sienas lādētāja metāla daļai.
5. Produkts ir paredzēts lietošanai tikai iekštelpās.
6. Ja maiņstrāvas spraudņu metāla tapiņa deformējas vai ir atskrūvējusies, pārtrauciet lietošanu.

Ja ir savienoti abi USB A porti, QC3,0 funkcija tiks atspējota

Viens izejas ports:

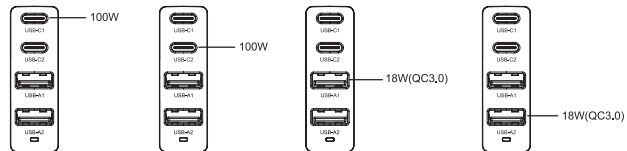

Divi izejas porti:

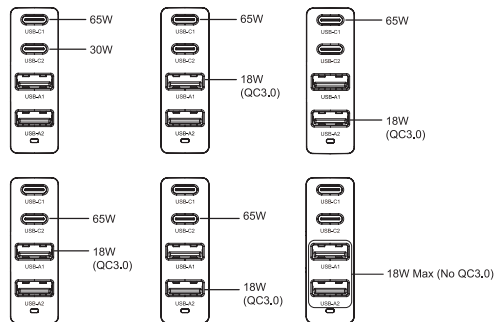

Trīs izejas porti:

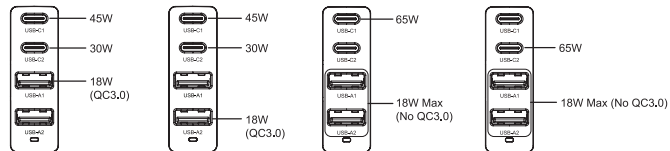

Visi izejas porti:

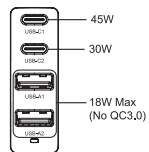

Informācija par ārējo barošanas avotu

Ražotājs	Targus International LLC
Adrese	1211 North Miller Street, Anaheim, CA 92806, ASV
Uzņēmuma reģistrācijas numurs	5892659
modelis/reģions	APA109
leejas spriegums	100-240V~
leejas maiņstrāvas frekvence	50/60Hz
Izejas spriegums	Viens ports: USB-C1/C2 PD: 5,0V/9,0V/12,0V/15,0V = 3,0A, 20,0V = 5,0A USB-C1/C2: PPS 3,30-21,0V = 5,0A 100,0W MAKS. USB-A1/A2 QC3,0: 5,0V = 3,0A, 9,0V = 2,0A, 12,0V = 1,5A, 18,0W MAKS.
Izejas strāva	Vairāki porti: USB-C1+USB-C2: 65,0W+30,0W USB-C1+USB-C2+USB-A1/A2: 45,0W+30,0W+18,0W (QC3,0) USB-C1/USB-C2+USB-A1+USB-A2: 65,0W+18,0W (NO QC3,0) USB-C1+USB-C2+USB-A1+USB-A2: 45,0W+30,0W+18,0W (NO QC3,0)
Izejas jauda	100,0W MAKS.

Vidējā aktīvā efektivitāte	Vairāki porti: USB-C1+USB-C2+USB-A1+USB-A2: (5,0V = 3,0A+5,0V = 3,0A+5,0V = 1,8A+5,0V = 1,8A):87,38 % USB-C1+USB-C2+USB-A1: (20,0V = 2,25A+20,0V = 1,5A+12,0V = 1,5A):88,92 % Viens ports: USB-C1: 20,0V = 5,0A:90,16 % USB-C1: 21,0V = 4,76A:90,33 %
Efektivitāte pie zemas slodzes (10 %)	Vairāki porti: USB-C1+USB-C2+USB-A1+USB-A2: (5,0V = 3,0A+5,0V = 3,0A+5,0V = 1,8A+5,0V = 1,8A):84,30 % USB-C1+USB-C2+USB-A1: (20,0V = 2,25A+20,0V = 1,5A+12,0V = 1,5A):81,36 % Viens ports: USB-C1: 20,0V = 5,0A:80,82 % USB-C1: 21,0V = 4,76A:85,28 %
Jaudas patēriņš bezslodzes režīmā	0.094W

Iepriekš minētā informācija ir pieejama importētāja tīmekļa vietnē www.targus.com

EE Sissejuhatus

See rahvusvaheliseks kasutamiseks mõeldud GaN-tehnoloogia ja vahetatavate pistikutega seinalaadija võimaldab laadida samaaegselt sülearvuteid, tahvelarvuteid, nutitelefone ja muid USB-toitega seadmeid erinevatelt kaubamärkidelt nagu Apple, Dell, Google, Lenovo, Samsung ja teised.

Komplektis

- Targus 100W GaN AC reisiadapter
- US, EU, UK, AU - AC pistik
- Kasutusjuhend

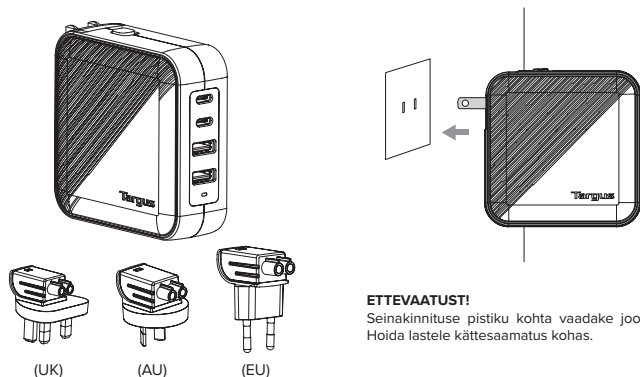
**Elektrilised näitajad**

Sisend: 100 - 240VAC 1.8A MAX 50/60Hz

Väljund:

Üksik port:

USB-C1/C2 PD: 5.0V/9.0V/12.0V/15.0V = 3.0A, 20.0V = 5.0A

USB-C1/C2: PPS 3.30-21.0V = 5.0A 100.0W MAX

USB-A1/A2 QC3.0: 5.0V = 3.0A, 9.0V = 2.0A, 12.0V = 1.5A, 18.0W MAX

Multi Port:

USB-C1+USB-C2: 65.0W+30.0W

USB-C1+USB-C2+USB-A1/A2: 45.0W+30.0W+18.0W (QC3.0)

USB-C1/C2+USB-A1+USB-A2: 65.0W+18.0W (NO QC3.0)

USB-C1+USB-C2+USB-A1+USB-A2: 45.0W+30.0W+18.0W (NO QC3.0)

Kokku: MAKS. 100,0 W

Kasutamine

Ese	Nõuded
Töotemperatuur	0 °C kuni 35 °C
Hoiustamistemperatuur	-20 °C kuni 85 °C
Suhteline niiskus	20% kuni 80%, mittekondenseeruv
Hoiustamise niiskus	5% kuni 95%, mittekondenseeruv
Pikaajaline kõrgus	Vähem kui 5000 m
Hoiustamiskõrgus	Vähem kui 15 000 m

OLULISED JUHISED VAHETATAVATE AC PISTIKUTE VAHETAMISEKS

Toimingud:

1. Enne kasutamist kontrollige vahetatava AC pistiku sobivust.

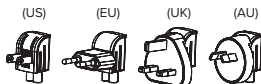

2. Vahetatavate AC pistikute (toimingute illustreerimiseks nt US AC pistik) vahetamiseks libistage esmalt pealmine hoob ettepoole ja seejärel eemaldage pistik.

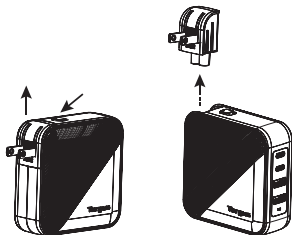

3. Libistage asjakohasesse riiki sobiv vahetatav AC pistik korpusesse.

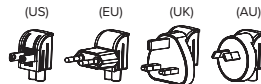

ENNE KASUTAMIST LUGEGE LÄBI KOGU KASUTUSJUHE!

OLULISED OHUTUSJUHISED

Ohutusnõuded

1. Veenduge alati, et seinalaadija nimivõimsus ühildub kasutatava pistikupesaga.
2. Seinalaadija peab olema korrektselt pistikupesasse sisestatud. Ärge kunagi kasutage seinalaadijat, kui pistiku klemm on pesast väljas.
3. Enne pistiku pesasse ühendamist veenduge, et vahetatav AC pistik sobib asjakohasesse riiki.
4. Ärge puudutage seinalaadija mistahes metallist osa, kui laadija on kasutuses.
5. Toode on mõeldud kasutamiseks ainult sisetingimustes.
6. Lõpetage toote kasutamine, kui mõne AC pistiku metallklemm on paindunud või lahti.

Kui mõlemad USB-A pordid on ühendatud, on funktsioon QC3.0 keelatud

Ühekordne väljundport:

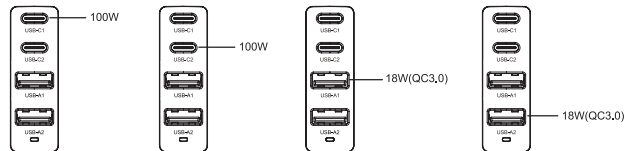

Kahekordne väljundport:

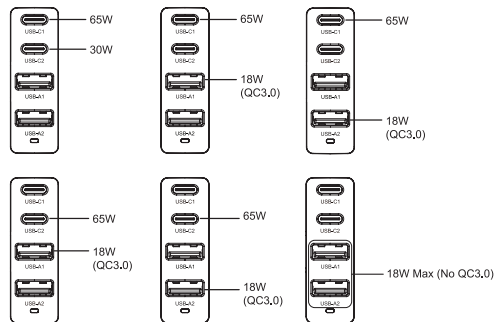

Kolmekordne väljundport:

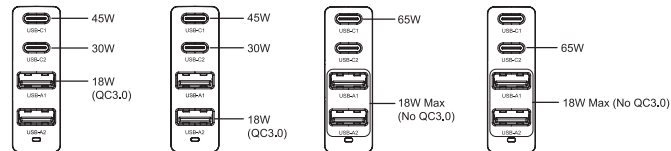

Kõik väljundpordid:

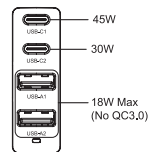

Välise toite teave

Tootja	Targus International LLC
Aadress	1211 North Miller Street, Anaheim, CA 92806 USA
Kaubanduslik Registreerimisnumber	5892659
Mudel/reg	APA109
Sisendpinge	100-240V~
AC sisendsagedus	50/60 Hz
Väljundpinge	Üksik port: USB-C1/C2 PD: 5.0V/9.0V/12.0V/15.0V == 3.0A, 20.0V == 5.0A USB-C1/C2: PPS 3.30-21.0V == 5.0A 100.0W MAX USB-A1/A2 QC3.0: 5.0V == 3.0A, 9.0V == 2.0A, 12.0V == 1.5A, 18.0W MAX
Väljundvool	Multi Port: USB-C1+USB-C2: 65.0W+30.0W USB-C1+USB-C2+USB-A1/A2: 45.0W+30.0W+18.0W (QC3.0) USB-C1+USB-C2+USB-A1+USB-A2: 65.0W+18.0W (NO QC3.0) USB-C1+USB-C2+USB-A1+USB-A2: 45.0W+30.0W+18.0W (NO QC3.0)
Väljundvõimus	100.0W MAX

Keskmine aktiivne tõhusus	Multi Port: USB-C1+USB-C2+USB-A1+USB-A2: (5.0V == 3.0A+5.0V == 3.0A+5.0V == 1.8A+5.0V == 1.8A):87.38% USB-C1+USB-C2+USB-A1: (20.0V == 2.25A+20.0V == 1.5A+12.0V == 1.5A):88.92% Üksik port: USB-C1: 20.0V == 5.0A:90.16% USB-C1: 21.0V == 4.76A:90.33%
Tõhusus madalal koormusel (10%)	Multi Port: USB-C1+USB-C2+USB-A1+USB-A2: (5.0V == 3.0A+5.0V == 3.0A+5.0V == 1.8A+5.0V == 1.8A):84.30% USB-C1+USB-C2+USB-A1: (20.0V == 2.25A+20.0V == 1.5A+12.0V == 1.5A):81.36% Üksik port: USB-C1: 20.0V == 5.0A:80.82% USB-C1: 21.0V == 4.76A:85.28%
Energiatarve koormuseta	0.094W

Ülaltoodud teave on saadaval maaletooja veebilehel www.targus.com

Technical Support

For technical questions, please visit:

US	Internet: http://targus.com/us/support
Canada	Internet: http://www.targus.com/ca/support
Australia	Internet: http://www.targus.com/au/support
	Email: infoaust@targus.com
	Telephone: 1800-641-645
New Zealand	Telephone: 0800-633-222
Latin America	Email: latam.soporte@targus.com

Internet

English	https://uk.targus.com/pages/support
French	https://fr.targus.com/pages/support
German	https://de.targus.com/pages/support
Spanish	https://es.targus.com/pages/support

Phone (language answered in):

Austria:	01 795 676 42 (German)
Belgium:	02-717-2451 (French)
Denmark:	+45 35 25 87 51 (English)
Finland:	+358 922948016 (English)
France:	01-6453-9151 (French)
Germany:	0211-6579-1151 (German)
Netherlands:	02 0504 0671 (English)
Norway:	+4722577729 (English)
Portugal:	+351 21 415 4123 (English)
South Africa:	+27 211 003 270 (English) - Calls answered 10am-6pm South African time
Spain:	91 745 6221 (Spanish)
Sweden:	08-751-4058 (English)
Switzerland:	+41 (0) 44 212 0007 (French or German)
UK:	020-7744-0330 (English)

Eastern Europe and others not listed above:

+44 (0) 207 744 0330 (English)

Product Registration

Targus recommends that you register your Targus accessory shortly after purchasing it. Go to:

http://targus.com/us/product_registration

You will need to provide your full name, email address, country of residence and product information.

2 YEARS LIMITED WARRANTY

PORTUGAL and SPAIN CUSTOMERS: 3 YEARS LIMITED WARRANTY

OR AS REQUIRED BY LOCAL LAWS

We pride ourselves on the quality of our products. For complete warranty details and a list of our Worldwide offices, please visit www.Targus.Com. Targus product warranty does not cover any device or product that is not manufactured by Targus (including, but not limited to, laptops, smartphones, devices, or any other product that may be used in connection with the Targus product). Targus is a registered trademark of Targus International LLC in the U.S. and in certain other countries. All logos and registered trademarks are the property of their respective owners. ©2022 Targus International LLC, 1211 North Miller St., Anaheim, CA 92806. All rights reserved.

FCC Statement

Tested to Comply

This equipment has been tested and found to comply with the limits of a Class B digital device, pursuant to Part 15 of the FCC Rules. These limits are designed to provide reasonable protection against harmful interference in a residential installation. This equipment generates, uses, and can radiate radio frequency energy, and if not installed and used in accordance with the instructions may cause harmful interference to radio communications. However, there is no guarantee that interference will not occur in a particular installation. If this equipment does cause harmful interference to radio or television reception, which can be determined by turning the equipment off and on, the user is encouraged to try to correct the interference by one or more of the following measures:

- Reorient or relocate the receiving antenna;
 - Increase the separation between the equipment and receiver;
 - Connect the equipment into an outlet on a circuit different from that to which the receiver is connected;
 - Consult the dealer or an experienced radio/TV technician for help
- Changes or modifications not authorized by the party responsible for compliance could void the user's authority to operate this product.

Regulatory Compliance

This device complies with Part 15 of the FCC Rules. Operation is subject to the following two conditions: (1) This device may not cause harmful interference, and (2) This device must accept any interference received, including interference that may cause undesired operation.

Declaration of Conformity

Hereby, Targus declares that this device is in compliance with the essential requirements and other relevant provisions of Directive 2014/30/EU. EU RoHS Directive 2011/65/EU and its amendment Directive (EU) 2015/863.

Targus Recycling Directive

At the end of this product's useful life please dispose at an appropriate recycling collection point provided in your country.

Australian And New Zealand Consumers Only

Thank you for your purchase. Targus warrants to the original purchaser that its products are free from defects in materials and workmanship and, during the specified warranty period, and lasts as long as the original purchaser owns the product. The warranty period is stated on the packaging or in the documentation provided with this Targus product. Targus' Limited Product Warranty excludes damage caused by accident, neglect, abuse, misuse, improper care, normal wear and tear, ownership transfer, or alteration. The limited warranty also excludes any product that is not manufactured by Targus (including, without limitation, laptops, smartphones, devices, tablets, or any other non-Targus item) that is used in connection with the Targus product.

In the event that the Targus product has a defect in materials or workmanship Targus will, after receiving a warranty claim and inspecting the product, at its discretion, do one of the following: repair, replace, or refund with the same or a similar product (or part) of no lesser quality and ship it to the original purchaser at Targus' expense. As part of this inspection, proof of purchase will be required. There is no charge for inspection. To make a warranty claim, please contact Targus Australia or New Zealand (see details below), or return the product to the place of purchase. The original purchaser must bear the cost of the delivery to Targus.

Under Australian and/or New Zealand Consumer Laws, in addition to any warranty Targus gives, our products come with guarantees that cannot be excluded. You are entitled to a replacement or refund for a major failure and compensation for any other reasonably foreseeable loss or damage. You are entitled to have the products repaired or replaced if they fail to be of acceptable quality and the failure does not amount to a major failure.

For any warranty question, contact Targus Australia Pty. Ltd. (i) by mail at Suite 2, Level 8, 5 Rider Boulevard, Rhodes NSW 2138, by phone AUS 1800 641 645 or NZ 0800 633 222 or by Email: infoaust@targus.com. For additional information, check out our website at targus.com/au/warranty.