

TIME- AND MONITORING RELAYS

TIME- AND MONITORING RELAYS



MEASURING AND MONITORING RELAYS

SERIES 5

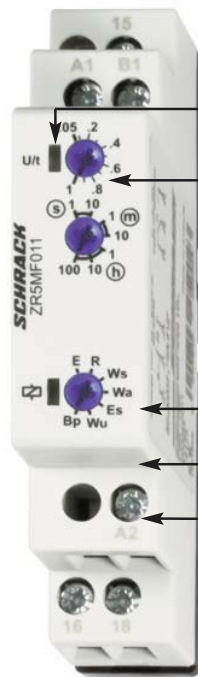

OPERATION DISPLAY

LARGE TIME RANGE 50 ms – 100 h

MANY FUNCTIONS

45 mm CAP DIMENSION

MULTI-VOLTAGE 12 or 24 V~/DC – 240 V~/DC

SERIES 6



INDUSTRIAL DESIGN

WIDTH 22.5 mm

MANY FUNCTIONS, E.G.:

- Monitoring of phase sequence and phase failure
- Detection of neutral wire break
- Windows function
- 16.6 – 400 Hz
- Thermal resistor relay
- Delayed contacts possible
- Time range of timer relay: 1 s to 30 days

TIME RELAY ZR5E0011



SCHRACK-INFO

Wide input voltage range
1 change over contact
Width 17,5 mm
Installation design

TECHNICAL DATA

1. Functions

The function has to be set before connecting the relay to the supply voltage.

E ON delay

2. Time ranges

| Time range | Adjustment range |
|------------|------------------|
| 1 s | 50 ms |
| 10 s | 500 ms |
| 1 min | 3 s |
| 10 min | 30 s |
| 1 h | 3 min |
| 10 h | 30 min |
| 100 h | 5 h |

3. Indicators

Green LED U/t ON: indication of supply voltage
Green LED U/t flashes: indication of time period
Yellow LED R ON/OFF: indication of relay outputs

4. Mechanical design

Self-extinguishing plastic housing, IP rating IP40
Mounted on DIN-rail TS 35 according to EN 50022
Mounting position: any
Shockproof terminal connection according to VBG 4 (PZ1 required), IP rating IP20
Tightening torque: max. 1 Nm
Terminal capacity:
1 x 0.5 to 2.5 mm² with/without multicore cable end
1 x 4 mm² without multicore cable end
2 x 0.5 to 1.5 mm² with/without multicore cable end
2 x 2.5 mm² flexible without multicore cable end

5. Input circuit

Supply voltage: Terminals A1(+)-A2
Types ZR5..24-240 V AC/DC: 24 to 240 V AC/DC
Tolerance: 24 V-15% to 240 V+10%
Rated consumption: 4 VA (1.5 W)
Rated frequency: AC 48 to 63 Hz
Duty cycle: 100%
Reset time: 100 ms
Residual ripple for DC: 10%
Drop-out voltage: >30% of minimum rated supply voltage
Overvoltage category: III (according to IEC 60664-1)
Rated surge voltage: 4 kV

6. Output circuit

1 potential free change over contact
Rated voltage: 250 V AC
Switching capacity: 2000 VA (8 A / 250V)
Fusing: 8 A fast acting
Mechanical life: 20 x 10⁵ operations
Electrical life: 2 x 10⁵ operations
at 1000 VA resistive load
Switching frequency: max. 60/min at 100 VA resistive load
max. 6/min at 1000 VA resistive load
(according to IEC 947-5-1)
Overvoltage category: III. (according to IEC 60664-1)
Rated surge voltage: 4 kV

7. Control input

Input not potential free: Terminals A1-B1
Loadable: yes
Max. line length: 10m
Trigger level (sensitivity): automatic adaption to supply voltage
Min. control pulse length: DC 50 ms / AC 100 ms

8. Accuracy

Base accuracy: ±1% of maximum scale value
Adjustment accuracy: <5% of maximum scale value
Repetition accuracy: <0.5% or ±5 ms
Voltage influence: -
Temperature influence: ≤0.01% / °C

9. Ambient conditions

Ambient temperature: -25 to +55 °C
(according to IEC 68-1)
Storage temperature: -25 to +70 °C
Transport temperature: -25 to +70 °C
Relative humidity: 15% to 85%
(according to IEC 721-3-3 class 3K3)
Pollution degree: 2, if built in 3
(according to IEC 664-1)
Vibration resistance: 10 to 55 Hz 0.35 mm
(according to IEC 68-2-6)
Shock resistance: 15 g 11 ms
(according to IEC 68-2-27)

FUNCTIONS

ON delay (E)

When the supply voltage U is applied, the set interval t begins (green LED U/t flashes). After the interval t has expired (green LED U/t illuminated) the output relay R switches into on-position (yellow LED illuminated). This status remains until the supply voltage is interrupted. If the supply voltage is interrupted before the expiry of the interval t, the interval already expired is erased and is restarted when the supply voltage is next applied.



CONNECTIONS

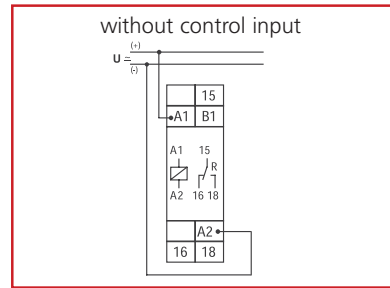

WEIGHT

Single packing: 72 g

DIMENSIONS

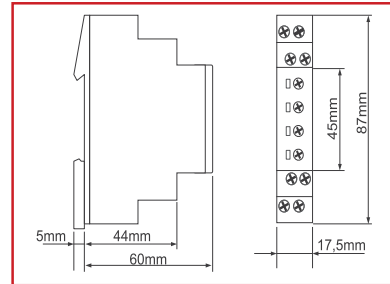

| DESCRIPTION | EAN CODE | AVAILABLE | ORDER NO. |
|--|---------------|-----------|-----------------|
| Single function time relay E (ON delay), 24-240VAC, 1 change over, 8A/250V | 9004840459029 | | ZR5E0011 |



I KNOW WHERE TO FIND IT!

THE SCHRACK TECHNIK WEB SHOP WITH NAVIGATOR
WWW.SCHRACK.COM

- Finding product information made easy
- Buying products around the clock
- Quick access customer service

TIME RELAY ZR5R0011



SCHRACK-INFO

Wide input voltage range
1 change over contact
Width 17,5 mm
Installation design

TECHNICAL DATA

1. Functions

The function has to be set before connecting the relay to the supply voltage.

R OFF delay

2. Time ranges

| Time range | Adjustment range | |
|------------|------------------|--------|
| 1 s | 50 ms | 1 s |
| 10 s | 500 ms | 10 s |
| 1 min | 3 s | 1 min |
| 10 min | 30 s | 10 min |
| 1 h | 3 min | 1 h |
| 10 h | 30 min | 10 h |
| 100 h | 5 h | 100 h |

3. Indicators

Green LED U/t ON: indication of supply voltage
Green LED U/t flashes: indication of time period
Yellow LED R ON/OFF: indication of relay outputs

4. Mechanical design

Self-extinguishing plastic housing, IP rating IP40
Mounted on DIN-rail TS 35 according to EN 50022
Mounting position: any
Shockproof terminal connection according to VBG 4 (PZ1 required), IP rating IP20
Tightening torque: max. 1 Nm
Terminal capacity:
1 x 0.5 to 2.5 mm² with/without multicore cable end
1 x 4 mm² without multicore cable end
2 x 0.5 to 1.5 mm² with/without multicore cable end
2 x 2.5 mm² flexible without multicore cable end

5. Input circuit

Supply voltage: Terminals A1(+)-A2
Types ZR5..24-240 V AC/DC: 24 to 240 V AC/DC
Tolerance: 24 V-15% to 240 V+10%
Rated consumption: 4 VA (1.5 W)
Rated frequency: AC 48 to 63 Hz
Duty cycle: 100%
Reset time: 100 ms
Residual ripple for DC: 10%
Drop-out voltage: >30% of minimum rated supply voltage
Overvoltage category: III (according to IEC 60664-1)
Rated surge voltage: 4 kV

6. Output circuit

1 potential free change over contact
Rated voltage: 250 V AC
Switching capacity: 2000 VA (8 A / 250V)
Fusing: 8 A fast acting
Mechanical life: 20 x 10⁵ operations
Electrical life: 2 x 10⁵ operations
at 1000 VA resistive load
Switching frequency: max. 60/min at 100 VA resistive load
max. 6/min at 1000 VA resistive load
(according to IEC 947-5-1)
Overvoltage category: III. (according to IEC 60664-1)
Rated surge voltage: 4 kV

7. Control input

Input not potential free: Terminals A1-B1
Loadable: yes
Max. line length: 10m
Trigger level (sensitivity): automatic adaption to supply voltage
Min. control pulse length: DC 50 ms / AC 100 ms

8. Accuracy

Base accuracy: ±1% of maximum scale value
Adjustment accuracy: <5% of maximum scale value
Repetition accuracy: <0.5% or ±5 ms
Voltage influence: -
Temperature influence: ≤0.01% / °C

9. Ambient conditions

Ambient temperature: -25 to +55 °C
(according to IEC 68-1)
Storage temperature: -25 to +70 °C
Transport temperature: -25 to +70 °C
Relative humidity: 15% to 85%
(according to IEC 721-3-3 class 3K3)
Pollution degree: 2, if built in 3
(according to IEC 664-1)
Vibration resistance: 10 to 55 Hz 0.35 mm
(according to IEC 68-2-6)
Shock resistance: 15 g 11 ms
(according to IEC 68-2-27)

FUNCTIONS

OFF delay (R)

The supply voltage U must be constantly applied to the device (green LED U/t illuminated). When the control contact S is closed, the output relay R switches into on-position (yellow LED illuminated). If the control contact is opened, the set interval t begins (green LED flashes). After the interval t has expired (green LED U/t illuminated) the output relay switches into off-position (yellow LED not illuminated). If the control contact is closed again before the interval t has expired, the interval already expired is erased and is restarted.

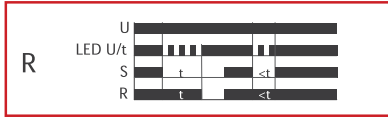

CONNECTIONS

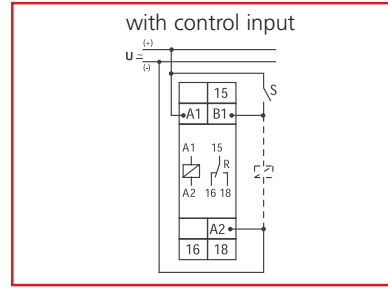

DIMENSIONS

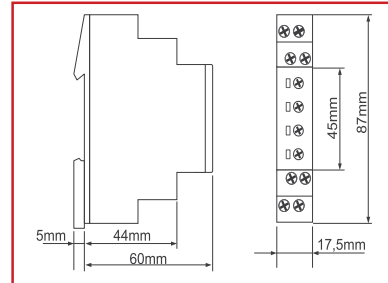

WEIGHT

Single packing: 72 g

| DESCRIPTION | EAN CODE | AVAILABLE | ORDER NO. |
|---|---------------|-----------|-----------------|
| Single function time relay R (OFF delay), 24-240VAC, 1 change over, 8A/250V | 9004840459050 | | ZR5R0011 |



I KNOW WHERE TO FIND IT!

WITH THE SCHRACK TECHNIK LiVE-PHONE APP

- Access technical product information at any time and from everywhere
- See availability and price immediately
- Order desired products easily

TIME RELAY ZR5ER011



SCHRACK-INFO

2 functions
7 time ranges
Wide input voltage range
1 change over contact
Width 17,5 mm
Installation design

TECHNICAL DATA

1. Functions

The function has to be set before connecting the relay to the supply voltage.

E ON delay
R OFF delay

2. Time ranges

| Time range | Adjustment range | |
|------------|------------------|--------|
| 1 s | 50 ms | 1 s |
| 10 s | 500 ms | 10 s |
| 1 min | 3 s | 1 min |
| 10 min | 30 s | 10 min |
| 1 h | 3 min | 1 h |
| 10 h | 30 min | 10 h |
| 100 h | 5 h | 100 h |

3. Indicators

Green LED U/t ON: indication of supply voltage
Green LED U/t flashes: indication of time period
Yellow LED R ON/OFF: indication of relay outputs

4. Mechanical design

Self-extinguishing plastic housing, IP rating IP40
Mounted on DIN-rail TS 35 according to EN 50022
Mounting position: any
Shockproof terminal connection according to VBG 4 (PZ1 required), IP rating IP20
Tightening torque: max. 1 Nm
Terminal capacity:
1 x 0.5 to 2.5 mm² with/without multicore cable end
1 x 4 mm² without multicore cable end
2 x 0.5 to 1.5 mm² with/without multicore cable end
2 x 2.5 mm² flexible without multicore cable end

5. Input circuit

Supply voltage: Terminals A1(+)-A2
Types ZR5..24-240 V AC/DC: 24 to 240 V AC/DC
Tolerance: 24 V-15% to 240 V+10%
Rated consumption: 4 VA (1.5 W)
Rated frequency: AC 48 to 63 Hz
Duty cycle: 100%
Reset time: 100 ms
Residual ripple for DC: 10%
Drop-out voltage: >30% of minimum rated supply voltage
Oversvoltage category: III (according to IEC 60664-1)
Rated surge voltage: 4 kV

6. Output circuit

1 potential free change over contact
Rated voltage: 250 V AC
Switching capacity: 2000 VA (8 A / 250V)
Fusing: 8 A fast acting
Mechanical life: 20 x 10⁵ operations
Electrical life: 2 x 10⁵ operations
at 1000 VA resistive load
Switching frequency: max. 60/min at 100 VA resistive load
max. 6/min at 1000 VA resistive load
(according to IEC 947-5-1)
Oversvoltage category: III. (according to IEC 60664-1)
Rated surge voltage: 4 kV

7. Control input

Input not potential free: Terminals A1-B1
Loadable: yes
Max. line length: 10m
Trigger level (sensitivity): automatic adaption to supply voltage
Min. control pulse length: DC 50 ms / AC 100 ms

8. Accuracy

Base accuracy: ±1% of maximum scale value
Adjustment accuracy: <5% of maximum scale value
Repetition accuracy: <0.5% or ±5 ms
Voltage influence: -
Temperature influence: ≤0.01% / °C

9. Ambient conditions

Ambient temperature: -25 to +55 °C
(according to IEC 68-1)
Storage temperature: -25 to +70 °C
Transport temperature: -25 to +70 °C
Relative humidity: 15% to 85%
(according to IEC 721-3-3 class 3K3)
Pollution degree: 2, if built in 3
(according to IEC 664-1)
Vibration resistance: 10 to 55 Hz 0.35 mm
(according to IEC 68-2-6)
Shock resistance: 15 g 11 ms
(according to IEC 68-2-27)

FUNCTIONS

ON delay (E)

When the supply voltage U is applied, the set interval t begins (green LED U/t flashes). After the interval t has expired (green LED U/t illuminated) the output relay R switches into on-position (yellow LED illuminated). This status remains until the supply voltage is interrupted. If the supply voltage is interrupted before the expiry of the interval t , the interval already expired is erased and is restarted when the supply voltage is next applied.

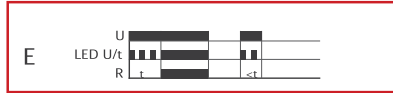

OFF delay (R)

The supply voltage U must be constantly applied to the device (green LED U/t illuminated). When the control contact S is closed, the output relay R switches into on-position (yellow LED illuminated). If the control contact is opened, the set interval t begins (green LED flashes). After the interval t has expired (green LED U/t illuminated) the output relay switches into off-position (yellow LED not illuminated). If the control contact is closed again before the interval t has expired, the interval already expired is erased and is restarted.

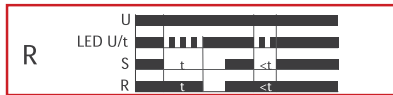

CONNECTIONS

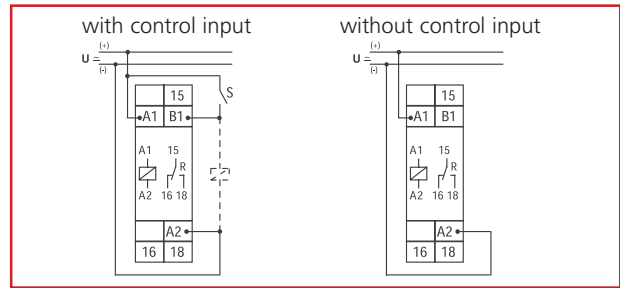

DIMENSIONS

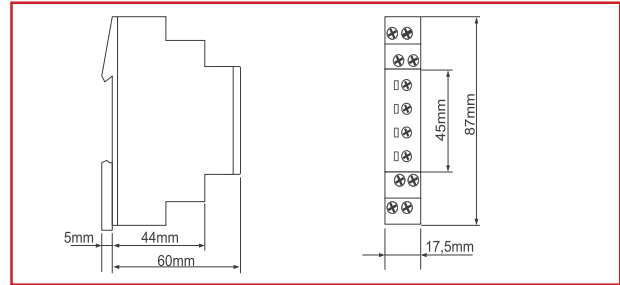

WEIGHT

Single packing: 72 g

| DESCRIPTION | EAN CODE | AVAILABLE | ORDER NO. |
|--|---------------|-----------|-----------------|
| Double function time relay E (ON delay) + R (OFF delay), 24-240VAC, 1 change over, 8A/250V | 9004840459036 | | ZR5ER011 |



I KNOW WHERE TO FIND IT!

THE SCHRACK TECHNIK WEB SHOP WITH NAVIGATOR
WWW.SCHRACK.COM

- Finding product information made easy
- Buying products around the clock
- Quick access customer service

MULTIFUNCTION TIME RELAY ZR5MF011



SCHRACK-INFO

- Timers multifunctional
- Up to 7 functions
- 7 time ranges
- Wide input voltage range
- 1 change over contact
- Width 17,5 mm
- Installation design

TECHNICAL DATA

1. Functions

The functions has to be set before connecting the relay to the supply voltage.

| | |
|----|--|
| E | ON delay |
| R | OFF delay |
| Ws | Single shot leading edge with control input |
| Wa | Single shot trailing edge with control input |
| Es | ON delay with control input |
| Wu | Single shot leading edge voltage controlled |
| Bp | Flasher pause first |

2. Time ranges

| Time range | Adjustment range | |
|------------|------------------|--------|
| 1 s | 50 ms | 1 s |
| 10 s | 500 ms | 10 s |
| 1 min | 3 s | 1 min |
| 10 min | 30 s | 10 min |
| 1 h | 3 min | 1 h |
| 10 h | 30 min | 10 h |
| 100 h | 5 h | 100 h |

3. Indicators

| | |
|------------------------|------------------------------|
| Green LED U/t ON: | indication of supply voltage |
| Green LED U/t flashes: | indication of time period |
| Yellow LED R ON/OFF: | indication of relay output |

4. Mechanical design

Self-extinguishing plastic housing, IP rating IP40
 Mounted on DIN-rail TS 35 according to EN 50022
 Mounting position: any
 Shockproof terminal connection according to VBG 4 (PZ1 required), IP rating IP20
 Tightening torque: max. 1 Nm
 Terminal capacity:
 1 x 0.5 to 2.5 mm² with/without multicore cable end
 1 x 4 mm² without multicore cable end
 2 x 0.5 to 1.5 mm² with/without multicore cable end
 2 x 2.5 mm² flexible without multicore cable end

5. Input circuit

| | |
|-------------------------|--------------------------------------|
| Supply voltage: | terminals A1(+)-A2 |
| Type ZR5MF025 | 12 to 240 V AC/DC |
| Tolerance: | 12 V-10% to 240 V+10% |
| Rated consumption: | 4 VA (1.5 W) |
| Rated frequency: | AC 48 to 63 Hz |
| Duty cycle: | 100% |
| Reset time: | 100 ms |
| Residual ripple for DC: | 10% |
| Drop-out voltage: | >30% of minimum rated supply voltage |

| | |
|-----------------------|--------------------------------|
| Overvoltage category: | III (according to IEC 60664-1) |
| Rated surge voltage: | 4kV |

6. Output circuit

| | |
|--------------------------------------|--|
| 1 potential free change over contact | |
| Rated voltage: | 250 V AC |
| Switching capacity: | 2000 VA (8 A / 250 V) |
| Fusing: | 8 A fast acting |
| Mechanical life: | 20 x 10 ⁶ operations |
| Electrical life: | 2 x 10 ⁵ operations at 1000 VA resistive load |
| Switching frequency: | max. 60/min at 100VA resistive load |
| | max. 6/min at 1000VA resistive load (according to IEC 947-5-1) |

| | |
|-----------------------|---------------------------------|
| Overvoltage category: | III. (according to IEC 60664-1) |
| Rated surge voltage: | 4kV |

7. Control input

| | |
|------------------------------|--------------------------------------|
| Input not potential free: | terminals A1-B1 |
| Loadable: | yes |
| Max. line length: | 10m |
| Trigger level (sensitivity): | automatic adaption to supply voltage |
| Min. control pulse length: | DC 50 ms / AC 100 ms |

8. Accuracy

| | |
|------------------------|----------------------------|
| Base accuracy: | ±1% of maximum scale value |
| Adjustment accuracy: | <5% of maximum scale value |
| Repetition accuracy: | <0.5% or ±5 ms |
| Voltage influence: | - |
| Temperature influence: | ≤0.01% / °C |

9. Ambient conditions

| | |
|------------------------|---|
| Ambient temperature: | -25 to +55 °C (according to IEC 68-1) |
| Storage temperature: | -25 to +70 °C |
| Transport temperature: | -25 to +70 °C |
| Relative humidity: | 15% to 85% (according to IEC 721-3-3 class 3K3) |
| Pollution degree: | 2, if built in 3 (according to IEC 664-1) |
| Vibrations resistance: | 10 to 55 Hz 0.35 mm (according to IEC 68-2-6) |
| Shock resistance: | 15 g 11 ms (according to IEC 68-2-27) |

FUNCTIONS

ON delay (E)

When the supply voltage U is applied, the set interval t begins (green LED U/t flashes). After the interval t has expired (green LED U/t illuminated) the output relay R switches into on-position (yellow LED illuminated). This status remains until the supply voltage is interrupted. If the supply voltage is interrupted before the expiry of the interval t, the interval already expired is erased and is restarted when the supply voltage is next applied.



OFF delay (R)

The supply voltage U must be constantly applied to the device (green LED U/t illuminated). When the control contact S is closed, the output relay R switches into on-position (yellow LED illuminated). If the control contact is opened, the set interval t begins (green LED U/t flashes). After the interval t has expired (green LED U/t illuminated) the output relay switches into off-position (yellow LED not illuminated). If the control contact is closed again before the interval t has expired, the interval already expired is erased and is restarted.

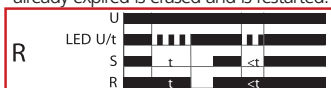

Single shot leading edge with control input (Ws)

The supply voltage U must be constantly applied to the device (green LED U/t illuminated). When the control contact S is closed, the output relay R switches into on-position (green LED U/t illuminated) and the set interval t begins (green LED U/t flashes). After the interval t has expired (green LED U/t illuminated) the output relay switches into off-position (yellow LED not illuminated). During the interval, the control contact can be operated any number of times. A further cycle can only be started when the cycle run has been completed.

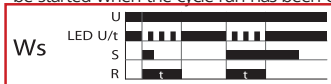

Single shot trailing edge with control input (Wa)

The supply voltage U must be constantly applied to the device (green LED U/t illuminated). Closing the control contact S has no influence on the condition of the output R. When the control contact is opened, the output relay switches into on-position (yellow LED illuminated) and the set interval t begins (green LED U/t flashes). After the interval t has expired (green LED U/t illuminated), the output relay switches into off-position (yellow LED not illuminated). During the interval, the control contact can be operated any number of times. A further cycle can only be started when the cycle run has been completed.

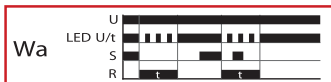

ON delay with control input (Es)

The supply voltage U must be constantly applied to the device (green LED U/t illuminated). When the control contact S is closed, the set interval t begins (green LED U/t flashes). After the interval t has expired (green LED U/t illuminated) the output relay R switches into on-position (yellow LED illuminated). This status remains until the control contact is opened again. If the control contact is opened before the interval t has expired, the interval already expired is erased and is restarted with the next cycle.



Single shot leading edge voltage controlled (Wu)

When the supply voltage U is applied, the output relay R switches into on-position (yellow LED illuminated) and the set interval t begins (green LED U/t flashes). After the interval t has expired (green LED U/t illuminated) the output relay switches into off-position (yellow LED not illuminated). This status remains until the supply voltage is interrupted. If the supply voltage is interrupted before the interval t has expired, the output relay switches into off-position. The interval already is erased and is restarted when the supply voltage is next applied.



Flasher pause first (Bp)

When the supply voltage U is applied, the set interval t begins (green LED U/t flashes). After the interval t has expired, the output relay R switches into on-position (yellow LED illuminated) and the set interval t begins again. After the interval t has expired, the output relay switches into off-position (yellow LED not illuminated). The output relay is triggered at a ratio of 1:1 until the supply voltage is interrupted.



CONNECTIONS

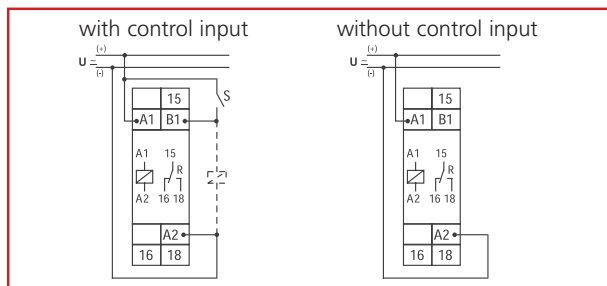

DIMENSIONS

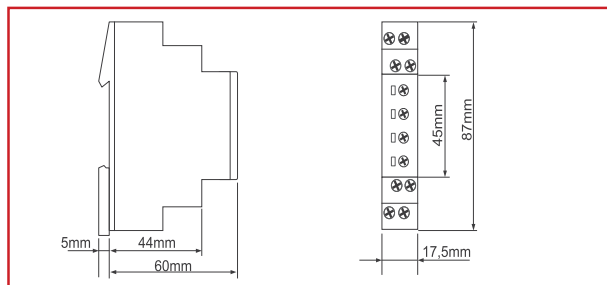

WEIGHT

Single packing: 72 g

| DESCRIPTION | EAN CODE | AVAILABLE | ORDER NO. |
|--|---------------|-----------|-----------|
| Multifunction time relay E, R, Ws, Wa, Es, Wu, Bp, 12-240VAC, 1 change over, 8A/250V | 9004840459043 | | ZR5MF011 |



MULTIFUNCTION TIME RELAY ZR5MF025



SCHRACK-INFO

- Timers multifunctional
- Up to 7 functions
- 7 time ranges
- Wide input voltage range
- 2 change-over contacts
- Width 35 mm
- Installation design

TECHNICAL DATA

1. Functions

The functions has to be set before connecting the relay to the supply voltage.

| | |
|----|--|
| E | ON delay |
| R | OFF delay |
| Ws | Single shot leading edge with control input |
| Wa | Single shot trailing edge with control input |
| Es | ON delay with control input |
| Wu | Single shot leading edge voltage controlled |
| Bp | Flasher pause first |

2. Time ranges

| Time range | Adjustment range | |
|------------|------------------|--------|
| 1 s | 50 ms | 1 s |
| 10 s | 500 ms | 10 s |
| 1 min | 3 s | 1 min |
| 10 min | 30 s | 10 min |
| 1 h | 3 min | 1 h |
| 10 h | 30 min | 10 h |
| 100 h | 5 h | 100 h |

3. Indicators

| | |
|------------------------|------------------------------|
| Green LED U/t ON: | indication of supply voltage |
| Green LED U/t flashes: | indication of time period |
| Yellow LED R ON/OFF: | indication of relay output |

4. Mechanical design

Self-extinguishing plastic housing, IP rating IP40
 Mounted on DIN-rail TS 35 according to EN 50022
 Mounting position: any
 Shockproof terminal connection according to VBG 4 (PZ1 required), IP rating IP20
 Tightening torque: max. 1 Nm
 Terminal capacity:
 1 x 0.5 to 2.5 mm² with/without multicore cable end
 1 x 4 mm² without multicore cable end
 2 x 0.5 to 1.5 mm² with/without multicore cable end
 2 x 2.5 mm² flexible without multicore cable end

5. Input circuit

| | |
|-------------------------|--------------------------------------|
| Supply voltage: | terminals A1(+)-A2 |
| Type ZR5MF025 | 12 to 240 V AC/DC |
| Tolerance: | 12 V-10% to 240 V+10% |
| Rated consumption: | 6 VA (2 W) |
| Rated frequency: | AC 48 to 63 Hz |
| Duty cycle: | 100% |
| Reset time: | 100 ms |
| Residual ripple for DC: | 10% |
| Drop-out voltage: | >30% of minimum rated supply voltage |

| | |
|-----------------------|--------------------------------|
| Overvoltage category: | III (according to IEC 60664-1) |
| Rated surge voltage: | 4kV |

6. Output circuit

| | |
|---------------------------------------|---|
| 2 potential free change over contacts | |
| Rated voltage: | 250 V AC |
| Switching capacity: | 2000 VA (8 A / 250 V) |
| Fusing: | 8 A fast acting |
| Mechanical life: | 20 x 10 ⁶ operations |
| Electrical life: | 2 x 10 ⁵ operations |
| Switching frequency: | at 1000 VA resistive load max. 60/min at 100VA resistive load max. 6/min at 1000VA resistive load (according to IEC 947-5-1) |

| | |
|-----------------------|---------------------------------|
| Overvoltage category: | III. (according to IEC 60664-1) |
| Rated surge voltage: | 4kV |

7. Control input

| | |
|------------------------------|--------------------------------------|
| Input not potential free: | terminals A1-B1 |
| Loadable: | yes |
| Max. line length: | 10m |
| Trigger level (sensitivity): | automatic adaption to supply voltage |
| Min. control pulse length: | DC 50 ms / AC 100 ms |

8. Accuracy

| | |
|------------------------|----------------------------|
| Base accuracy: | ±1% of maximum scale value |
| Adjustment accuracy: | <5% of maximum scale value |
| Repetition accuracy: | <0.5% or ±5 ms |
| Voltage influence: | - |
| Temperature influence: | ≤0.01% / °C |

9. Ambient conditions

| | |
|------------------------|--|
| Ambient temperature: | -25 to +55 °C (according to IEC 68-1) |
| Storage temperature: | -25 to +70 °C |
| Transport temperature: | -25 to +70 °C |
| Relative humidity: | 15% to 85% (according to IEC 721-3-3 class 3K3) |
| Pollution degree: | 2, if built in 3 (according to IEC 664-1) |
| Vibrations resistance: | 10 to 55 Hz 0.35 mm (according to IEC 68-2-6) |
| Shock resistance: | 15 g 11 ms (according to IEC 68-2-27) |

FUNCTIONS

ON delay (E)

When the supply voltage U is applied, the set interval t begins (green LED U/t flashes). After the interval t has expired (green LED U/t illuminated) the output relay R switches into on-position (yellow LED illuminated). This status remains until the supply voltage is interrupted. If the supply voltage is interrupted before the expiry of the interval t, the interval already expired is erased and is restarted when the supply voltage is next applied.



OFF delay (R)

The supply voltage U must be constantly applied to the device (green LED U/t illuminated). When the control contact S is closed, the output relay R switches into on-position (yellow LED illuminated). If the control contact is opened, the set interval t begins (green LED U/t flashes). After the interval t has expired (green LED U/t illuminated) the output relay switches into off-position (yellow LED not illuminated). If the control contact is closed again before the interval t has expired, the interval already expired is erased and is restarted.



Single shot leading edge with control input (Ws)

The supply voltage U must be constantly applied to the device (green LED U/t illuminated). When the control contact S is closed, the output relay R switches into on-position (green LED U/t illuminated) and the set interval t begins (green LED U/t flashes). After the interval t has expired (green LED U/t illuminated) the output relay switches into off-position (yellow LED not illuminated). During the interval, the control contact can be operated any number of times. A further cycle can only be started when the cycle run has been completed.



Single shot trailing edge with control input (Wa)

The supply voltage U must be constantly applied to the device (green LED U/t illuminated). Closing the control contact S has no influence on the condition of the output R. When the control contact is opened, the output relay switches into on-position (yellow LED illuminated) and the set interval t begins (green LED U/t flashes). After the interval t has expired (green LED U/t illuminated), the output relay switches into off-position (yellow LED not illuminated). During the interval, the control contact can be operated any number of times. A further cycle can only be started when the cycle run has been completed.

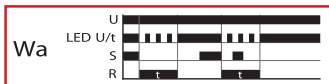

ON delay with control input (Es)

The supply voltage U must be constantly applied to the device (green LED U/t illuminated). When the control contact S is closed, the set interval t begins (green LED U/t flashes). After the interval t has expired (green LED U/t illuminated) the output relay R switches into on-position (yellow LED illuminated). This status remains until the control contact is opened again. If the control contact is opened before the interval t has expired, the interval already expired is erased and is restarted with the next cycle.



Single shot leading edge voltage controlled (Wu)

When the supply voltage U is applied, the output relay R switches into on-position (yellow LED illuminated) and the set interval t begins (green LED U/t flashes). After the interval t has expired (green LED U/t illuminated) the output relay switches into off-position (yellow LED not illuminated). This status remains until the supply voltage is interrupted. If the supply voltage is interrupted before the interval t has expired, the output relay switches into off-position. The interval already is erased and is restarted when the supply voltage is next applied.



Flasher pause first (Bp)

When the supply voltage U is applied, the set interval t begins (green LED U/t flashes). After the interval t has expired, the output relay R switches into on-position (yellow LED illuminated) and the set interval t begins again. After the interval t has expired, the output relay switches into off-position (yellow LED not illuminated). The output relay is triggered at a ratio of 1:1 until the supply voltage is interrupted.



CONNECTIONS

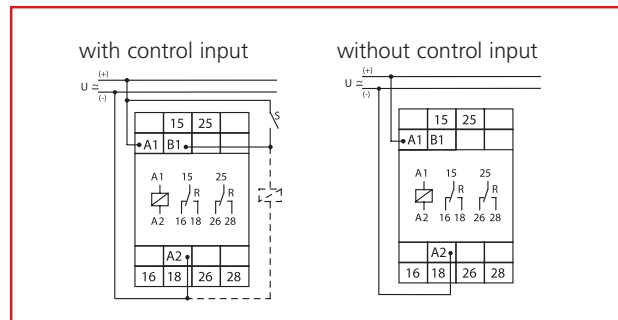

DIMENSIONS

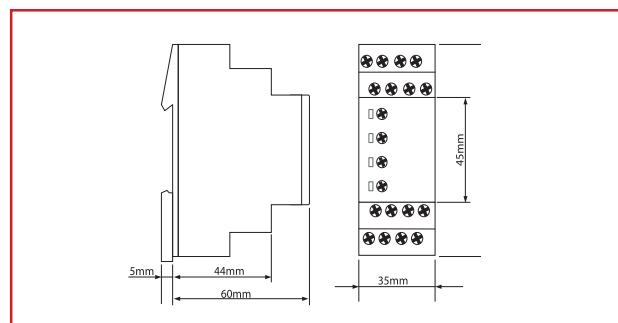

WEIGHT

Single packing: 106g

| DESCRIPTION | EAN CODE | AVAILABLE | ORDER NO. |
|---|---------------|-----------|-----------------|
| Multifunction time relay, 12-240VAC, 2 change over, 8A/250V | 9004840507287 | | ZR5MF025 |

MULTIFUNCTION TIME RELAY ZR6MF052



- 16 functions
- 16 time ranges
- Connection of remote potentiometer possible
- Zoom voltage 24 to 240V AC/DC
- 2 change-over contacts
- Width 22.5 mm
- Industrial design

TECHNICAL DATA

1. Functions

| | |
|--|--|
| 1 delayed contact (terminals 15-16-18) and | |
| 1 instantaneous contact (terminals 25-26-28) | |
| E11 | ON delay |
| R11 | OFF delay with control contact |
| Es11 | ON delay with control contact |
| Wu11 | Single shot leading edge voltage controlled |
| Ws11 | Single shot leading edge with control contact |
| Wa11 | Single shot trailing edge with control contact |
| Bi11 | Flasher pulse first |
| Bp11 | Flasher pause first |

2 delayed contacts

| | |
|------|--|
| E20 | ON delay |
| R20 | OFF delay with control contact |
| Es20 | ON delay with control contact |
| Wu20 | Single shot leading edge voltage controlled |
| Ws20 | Single shot leading edge with control contact |
| Wa20 | Single shot trailing edge with control contact |
| Bi20 | Flasher pulse first |
| Bp20 | Flasher pause first |

2. Time ranges

| Time range | Adjustment range | |
|------------|------------------|-------|
| 1s | 50ms | 1s |
| 3s | 150ms | 3s |
| 10s | 500ms | 10s |
| 30s | 1500ms | 30s |
| 1min | 3s | 1min |
| 3min | 9s | 3min |
| 10min | 30s | 10min |
| 30min | 90s | 30min |
| 1h | 3min | 1h |
| 3h | 9min | 3h |
| 10h | 30min | 10h |
| 30h | 90min | 30h |
| 1d | 72min | 1d |
| 3d | 216min | 3d |
| 10d | 12h | 10d |
| 30d | 36h | 30d |

3. Indicators

| | |
|--------------------|------------------------------|
| Green LED ON: | indication of supply voltage |
| Green LED flashes: | indication of time period |
| Yellow LED ON/OFF: | indication of relay output |

4. Mechanical design

| |
|--|
| Self-extinguishing plastic housing, IP rating IP40 |
| Mounted on DIN-Rail TS 35 according to EN 60715 |
| Mounting position: any |
| Shockproof terminal connection according to VBG 4 (PZ1 required), IP rating IP20 |
| Tightening torque: max. 1Nm |
| Terminal capacity: |
| 1 x 0.5 bis 2.5 mm ² with/without multicore cable end |
| 1 x 4 mm ² without multicore cable end |
| 2 x 0.5 bis 1.5 mm ² with/without multicore cable end |
| 2 x 2.5 mm ² flexible without multicore cable end |

5. Input circuit

| | | |
|-------------------------|------------------|--|
| Supply voltage: | 24 to 240V AC/DC | terminals A1-A2 (galvanically separated) |
| Tolerance: | 24 to 240V DC | -20% to +25% |
| | 24 to 240V AC | -15% to +10% |
| Rated frequency: | 24 to 240V AC | 48 to 400Hz |
| | 48 to 240V AC | 16 to 48Hz |
| Rated consumption: | | 4.5VA (1W) |
| Duration of operation: | | 100% |
| Reset time: | | 500ms |
| Wave form for AC: | | Sinus |
| Residual ripple for DC: | | 10% |
| Drop-out voltage: | | >15% of the supply voltage |
| Overvoltage category: | | III (in accordance with IEC 60661-1) |
| Rated surge voltage: | | 4kV |

6. Output circuit

| | |
|---------------------------------------|--|
| 2 potential free change-over contacts | |
| Rated voltage: | 250V AC |
| Switching capacity (distance <5mm): | 750VA (3A / 250V AC) |
| Switching capacity (distance >5mm): | 1250VA (5A / 250V AC) |
| Fusing: | 5A fast acting |
| Mechanical life: | 20 x 10 ⁶ operations |
| Electrical Life: | 2 x 10 ⁵ operations at 1000VA resistive load |
| Switching frequency: | max. 60/min at 100VA resistive load max. 6/min at 1000VA resistive load (in accordance with IEC 60947-5-1) |
| Overvoltage category: | III (in accordance with IEC 60664-1) |
| Rated surge voltage: | 4kV |

7. Control contact

| | |
|------------------------|--|
| Activation: | bridge Y1-Y2 |
| Potential free: | yes, basic isolation against input and output circuit |
| Loadable: | no |
| Control voltage: | max. 5V |
| Short circuit current: | max. 1mA |
| Line length: | max. 10m |
| Control pulse length: | min. 50ms |

8. Remote potentiometer (not included)

The internal potentiometer is de-activated when a remote potentiometer is connected!

| | |
|------------------------|---|
| Connections: | 1M Ω potentiometer (type RONDO R2), terminals Z1-Y2 |
| Line type: | twisted pair |
| Control voltage: | max. 5V |
| Short circuit current: | max. μ A |
| Line length: | max. 5m |

9. Accuracy

| | |
|------------------------|---|
| Base accuracy: | $\pm 1\%$ (of maximum scale value) using 1M Ω remote potentiometer |
| Frequency response: | - |
| Adjustment accuracy: | $\leq 5\%$ (of maximum scale value) using 1M Ω remote potentiometer |
| Repetition accuracy: | <0.5% or ± 5 ms |
| Voltage influence: | - |
| Temperature influence: | $\leq 0.01\%$ / $^{\circ}$ C |

10. Ambient conditions

| | |
|------------------------|---|
| Ambient temperature: | -25 to +55 $^{\circ}$ C (in accordance with IEC 60068-1) -25 to +40 $^{\circ}$ C (in accordance with UL 508) |
| Storage temperature: | -25 to +70 $^{\circ}$ C |
| Transport temperature: | -25 to +70 $^{\circ}$ C |
| Relative humidity: | 15% to 85% (in accordance with IEC 60721-3-3 class 3K3) |
| Pollution degree: | 3 (in accordance with IEC 60664-1) |
| Vibration resistance: | 10 to 55Hz 0.35 mm (in accordance with IEC 60068-2-6) |
| Shock resistance: | 15g 11ms (in accordance with IEC 60068-2-27) |

FUNCTIONS

The internal potentiometer is de-activated when a remote-potentiometer is connected! The function has to be set before connecting the relay to the supply voltage.

ON delay (E11)

When the supply voltage U is applied, the instantaneous contact switches into on-position and the set interval t begins (green LED flashes). After the interval t has expired (green LED illuminated) the delayed contact switches into on-position (yellow LED illuminated). This status remains until the supply voltage is interrupted. If the supply voltage is interrupted before the expiry of the interval t, the interval already expired is erased and is restarted when the supply voltage is next applied.

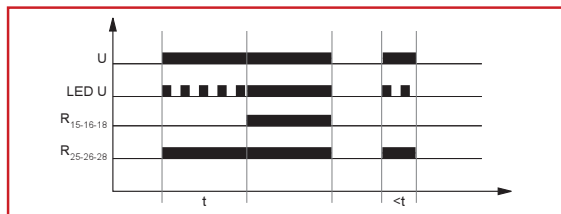

OFF delay with control contact (R11)

The supply voltage U must be constantly applied to the device (green LED illuminated). When the control contact Y1-Y2 is closed, both contacts switch into on-position (yellow LED illuminated). If the control contact is opened, the instantaneous contact switches into off-position and the set interval t begins (green LED flashes). After the interval t has expired (green LED illuminated) the delayed contact switches into off-position (yellow LED not illuminated). If the control contact is closed again before the interval t has expired, the interval already expired is erased and is restarted with the next cycle.

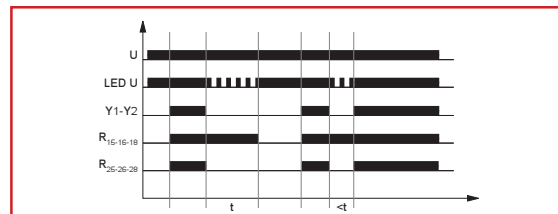

ON delay with control contact (Es11)

The supply voltage U must be constantly applied to the device (green LED illuminated). When the control contact Y1-Y2 is closed, the instantaneous contact switches into on-position and the set interval t begins (green LED flashes). After the interval t has expired (green LED illuminated) the delayed contact switches into on-position (yellow LED illuminated). This status remains until the control contact is opened again. If the control contact is opened before the interval t has expired, the interval already expired is erased and is restarted with the next cycle.

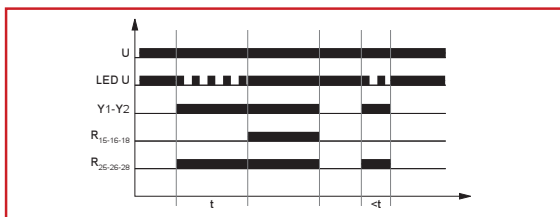

Single shot leading edge voltage controlled (Wu11)

When the supply voltage U is applied, both contacts switch into on-position (yellow LED illuminated) and the set interval t begins (green LED flashes). After the interval t has expired (green LED illuminated) the delayed contact switches into off-position (yellow LED not illuminated). This status remains until the supply voltage is interrupted. If the supply voltage is interrupted before the interval t has expired, the both contacts switch into off-position. The interval already expired is erased and is restarted when the supply voltage is next applied.



Single shot leading edge with control contact (Ws11)

The supply voltage U must be constantly applied to the device (green LED illuminated). When the control contact Y1-Y2 is closed, both contacts switch into on-position (yellow LED illuminated) and the set interval t begins (green LED flashes). After the interval t has expired (green LED illuminated) the delayed contact switches into off-position (yellow LED not illuminated). The instantaneous contact remains in on-position, until the control contact is opened again. During the interval, the control contact (and the instantaneous contact) can be operated any number of times. A further cycle can only be started when the cycle run has been completed.

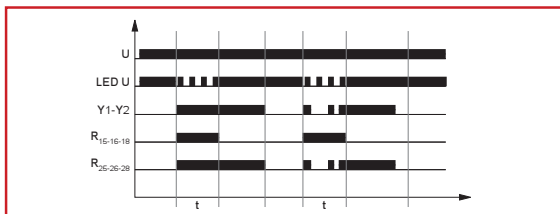

Single shot trailing edge with control contact (Wa11)

The supply voltage U must be constantly applied to the device (green LED illuminated). When the control contact Y1-Y2 is closed the instantaneous contact switches into on-position. When the control contact is opened, the instantaneous contact switches into off-position, the delayed contact switches into on-position (yellow LED illuminated) and the set interval t begins (green LED flashes). After the interval t has expired (green LED illuminated), the delayed contact switches into off-position (yellow LED not illuminated). During the interval, the control contact (and the instantaneous contact) can be operated any number of times. A further cycle can only be started when the cycle run has been completed.

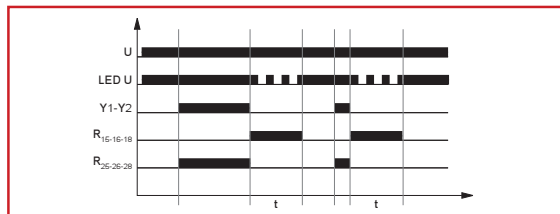

Flasher pulse first (Bi11)

When the supply voltage U is applied, the instantaneous contact and the delayed contact switch into on-position (yellow LED illuminated) and the set interval t begins (green LED flashes). After the interval t has expired, the delayed contact switches into off-position (yellow LED not illuminated) and the set interval t begins again. The delayed contact is triggered at a ratio of 1:1 until the supply voltage is interrupted.

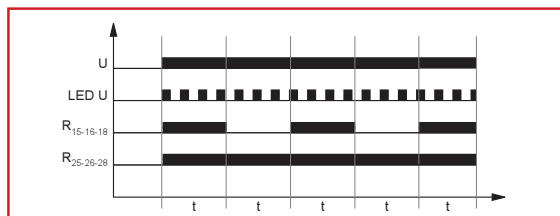

Flasher pause first (Bp11)

When the supply voltage U is applied, the instantaneous contact switches into on-position and the set interval t begins (green LED flashes). After the interval t has expired, the delayed contact switches into on-position (yellow LED illuminated) and the set interval t begins again. After the interval t has expired, the delayed contact switches into off-position (yellow LED not illuminated). The delayed contact is triggered at a ratio of 1:1 until the supply voltage is interrupted.

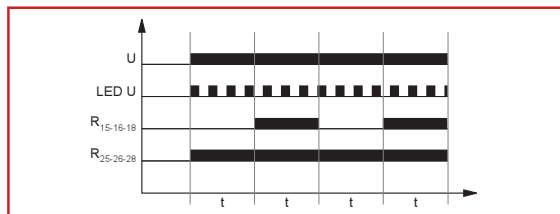

ON delay (E20)

When the supply voltage U is applied, the set interval t begins (green LED flashes). After the interval t has expired (green LED illuminated) the output relay R switches into on-position (yellow LED illuminated). This status remains until the supply voltage is interrupted. If the supply voltage is interrupted before the expiry of the interval t , the interval already expired is erased and is restarted when the supply voltage is next applied.

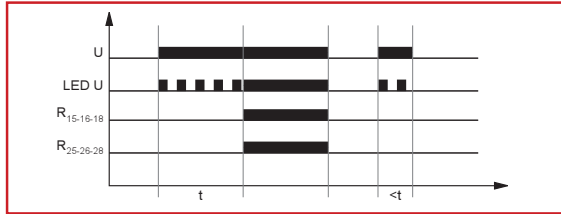

OFF delay with control contact (R20)

The supply voltage U must be constantly applied to the device (green LED illuminated). When the control contact $Y1-Y2$ is closed, the output relay R switches into on-position (yellow LED illuminated). If the control contact is opened, the set interval t begins (green LED flashes). After the interval t has expired (green LED illuminated) the output relay switches into off-position (yellow LED not illuminated). If the control contact is closed again before the interval t has expired, the interval already expired is erased and is restarted with the next cycle.

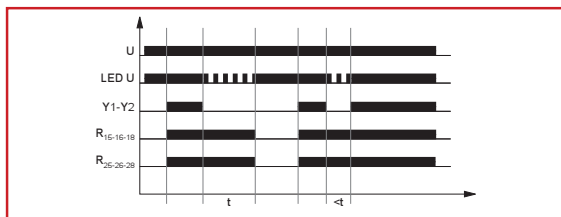

ON delay with control contact (Es20)

The supply voltage U must be constantly applied to the device (green LED illuminated). When the control contact $Y1-Y2$ is closed, the set interval t begins (green LED flashes). After the interval t has expired (green LED illuminated) the output relay R switches into on-position (yellow LED illuminated). This status remains until the control contact is opened again. If the control contact is opened before the interval t has expired, the interval already expired is erased and is restarted with the next cycle.

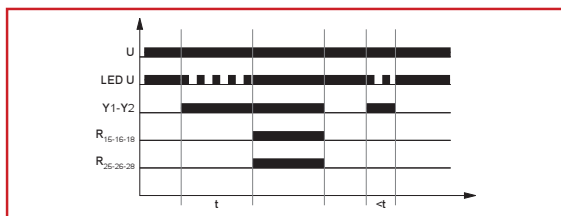

Single shot leading edge voltage controlled (Wu20)

When the supply voltage U is applied, the output relay R switches into on-position (yellow LED illuminated) and the set interval t begins (green LED flashes). After the interval t has expired (green LED illuminated) the output relay switches into off-position (yellow LED not illuminated). This status remains until the supply voltage is interrupted. If the supply voltage is interrupted before the interval t has expired, the output relay switches into off-position. The interval already expired is erased and is restarted when the supply voltage is next applied.

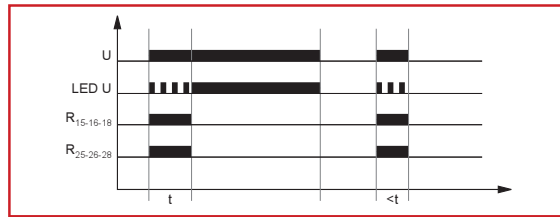

Single shot leading edge with control contact (Ws20)

The supply voltage U must be constantly applied to the device (green LED illuminated). When the control contact $Y1-Y2$ is closed, the output relay R switches into on-position (yellow LED illuminated) and the set interval t begins (green LED flashes). After the interval t has expired (green LED illuminated) the output relay switches into off-position (yellow LED not illuminated). During the interval, the control contact can be operated any number of times. A further cycle can only be started when the cycle run has been completed.

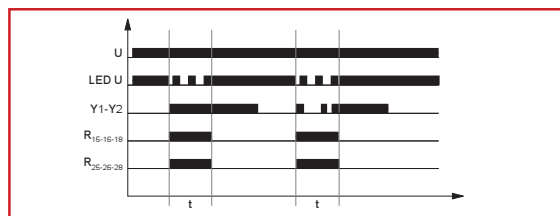

Single shot trailing edge with control contact (Wa20)

The supply voltage U must be constantly applied to the device (green LED illuminated). Closing the control contact $Y1-Y2$ has no influence on the condition of the output relay R . When the control contact is opened, the output relay switches into on-position (yellow LED illuminated) and the set interval t begins (green LED flashes). After the interval t has expired (green LED illuminated), the output relay switches into off-position (yellow LED not illuminated). During the interval, the control contact can be operated any number of times. A further cycle can only be started when the cycle run has been completed.

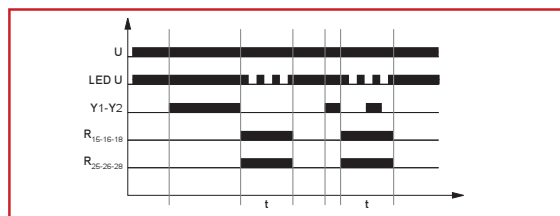

TIME RELAYS

Flasher pulse first (Bi20)

When the supply voltage U is applied, the output relay R switches into on-position (yellow LED illuminated) and the set interval t begins (green LED flashes). After the interval t has expired, the output relay switches into off-position (yellow LED not illuminated) and the set interval t begins again. The output relay is triggered at a ratio of 1:1 until the supply voltage is interrupted.

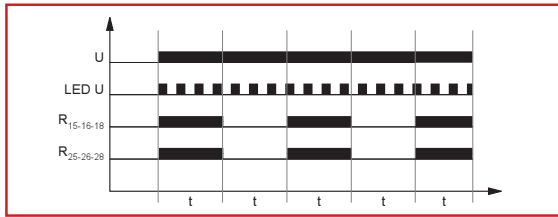

Flasher pause first (Bp20)

When the supply voltage U is applied, the set interval t begins (green LED flashes). After the interval t has expired, the output relay R switches into on-position (yellow LED illuminated) and the set interval t begins again. After the interval t has expired, the output relay switches into off-position (yellow LED not illuminated). The output relay is triggered at a ratio of 1:1 until the supply voltage is interrupted.

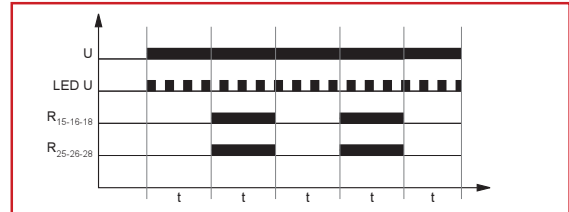

CONNECTIONS

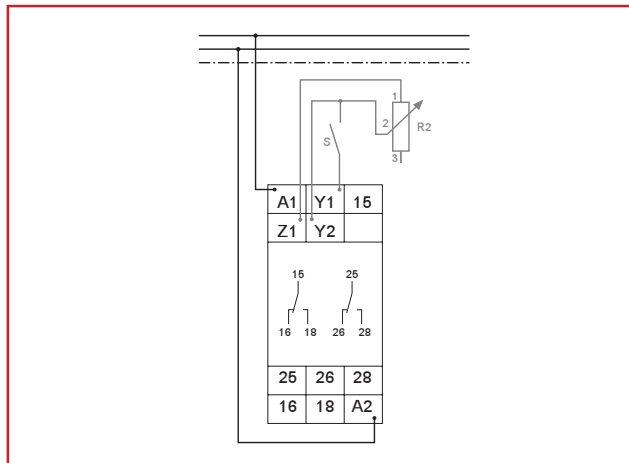

DIMENSIONS

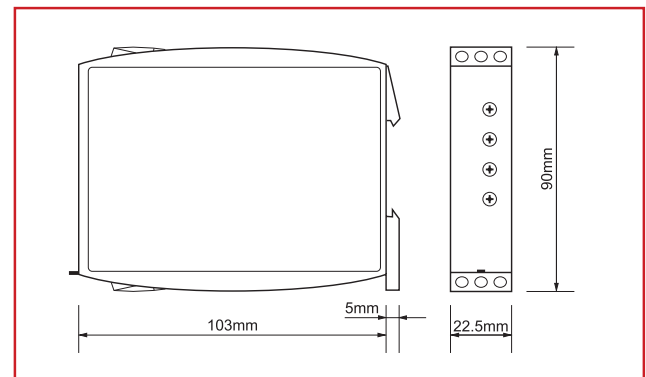

| DESCRIPTION | EAN CODE | AVAILABLE | ORDER NO. |
|---|---------------|-----------|------------------|
| Multifunction time relay, 2 change over, 24-240V AC/DC, industrial design | 9004840557466 | | ZRG6MF052 |



I KNOW WHERE TO FIND IT!

WITH THE SCHRACK TECHNIK LIVE-PHONE APP

- Access technical product information at any time and from everywhere
- See availability and price immediately
- Order desired products easily

FLASHER TIME RELAY ZR5B0011



SCHRACK-INFO

- Asymmetric flasher
- 7 time ranges
- Wide input voltage range
- 1 change over contact
- Width 17,5 mm
- Installation design

TECHNICAL DATA

1. Functions

lp Asymmetric flasher pause first
li Asymmetric flasher pulse first
(A1-B1 bridged)

2. Time ranges

| Time range | Adjustment range | |
|------------|------------------|--------|
| 1 s | 50 ms | 1 s |
| 10 s | 500 ms | 10 s |
| 1 min | 3 s | 1 min |
| 10 min | 30 s | 10 min |
| 1 h | 3 min | 1 h |
| 10 h | 30 min | 10 h |
| 100 h | 5 h | 100 h |

3. Indicators

Green LED U/t ON: indication of supply voltage
Green LED U/t slow flashing: indication of time period t1
Green LED U/t fast flashing: indication of time period t2
Yellow LED R ON/OFF: indication of relay output

4. Mechanical design

Self-extinguishing plastic housing, IP rating IP40
Mounted on DIN-rail TS 35 according to EN 50022
Mounting position: any
Shockproof terminal connection according to VBG 4 (PZ1 required), IP rating IP20
Tightening torque: max. 1 Nm
Terminal capacity:
1 x 0.5 to 2.5 mm² with/without multicore cable end
1 x 4 mm² without multicore cable end
2 x 0.5 to 1.5 mm² with/without multicore cable end
2 x 2.5mm² flexible without multicore cable end

5. Input circuit

Supply voltage: Terminals A1(+)-A2
Type ZR5B0011
12-240 V AC/DC:
Tolerance: 12 V-10% to 240 V+10%
Rated consumption: 4 VA (1.5 W)
Rated frequency: AC 48 to 63 Hz
Duty cycle: 100%
Reset time: 100 ms
Residual ripple for DC: 10%
Drop-out voltage: >30% of minimum rated supply voltage
Overvoltage category: III (according to IEC 60664-1)
Rated surge voltage: 4 kV

6. Output circuit

1 potential free change over contact
Rated voltage: 250 V AC
Switching capacity: 2000 VA (8 A / 250 V)
Fusing: 8 A fast acting
Mechanical life: 20 x 10⁶ operations
Electrical life: 2 x 10⁵ operations
at 1000 VA resistive load
max. 60/min at 100 VA resistive load
max. 6/min at 1000 VA resistive load
(according to IEC 947-5-1)
Overvoltage category: III. (according to IEC 60664-1)
Rated surge voltage: 4 kV

7. Control input

Input not potential free: Terminals A1-B1
Loadable: yes
Max. line length: 10 m
Trigger level (sensitivity): automatic adaption to supply voltage
Min. control pulse length: DC 50 ms / AC 100 ms

8. Accuracy

Base accuracy: ±1% of maximum scale value
Adjustment accuracy: <5% of maximum scale value
Repetition accuracy: <0.5% or ±5 ms
Voltage influence: -
Temperature influence: ≤0.01% / °C

9. Ambient conditions

Ambient temperature: -25 to +55 °C (according to IEC 68-1)
Storage temperature: -25 to +70 °C
Transport temperature: -25 to +70 °C
Relative humidity: 15% to 85%
(according to IEC 721-3-3 class 3K3)
Pollution degree: 2, if built in 3
(according to IEC 664-1)
Vibration resistance: 10 to 55 Hz 0.35 mm
(according to IEC 68-2-6)
Shock resistance: 15 g 11 ms
(according to IEC 68-2-27)

TIME RELAYS

FUNCTIONS

Asymmetric flasher pause first (Ip)

When the supply voltage U is applied, the set interval t_1 begins (green LED U/t flashes slowly). After the interval t_1 has expired, the output relay R switches into on-position (yellow LED illuminated) and the set interval t_2 begins (green LED U/t flashes fast). After the interval t_2 has expired, the output relay switches into off-position (yellow LED not illuminated).

The output relay is triggered at the ratio of $t_1:t_2$ until the supply voltage is interrupted.

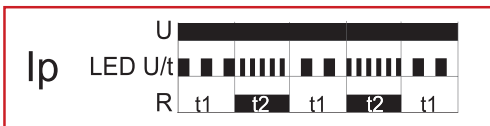

CONNECTIONS

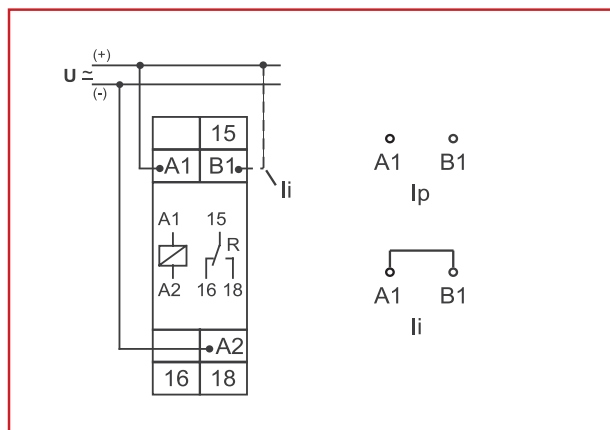

Asymmetric flasher pulse first (Ii)

When the supply voltage U is applied, the output relay R switches into on-position (yellow LED illuminated) and the set interval t_1 begins (green LED U/t flashes slowly). After the interval t_1 has expired, the output relay switches into off-position (yellow LED not illuminated) and the set interval t_2 begins (green LED U/t flashes fast). After the interval t_2 has expired, the output relay switches into on-position (yellow LED illuminated).

The output relay is triggered at the ratio of $t_1:t_2$ until the supply voltage is interrupted.

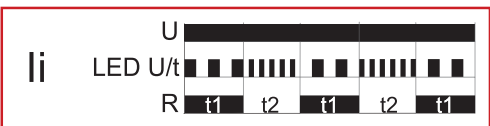

DIMENSIONS

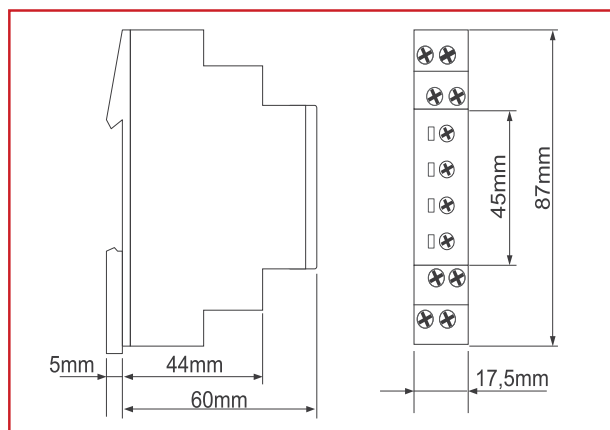

WEIGHT

Single packing: 72 g

| DESCRIPTION | EAN CODE | AVAILABLE | ORDER NO. |
|---|---------------|-----------|-----------------|
| Flasher time relay, 12-240VAC, 1 change over, 8A/250V | 9004840459012 | | ZR5B0011 |



I KNOW WHERE TO FIND IT!

THE SCHRACK TECHNIK WEB SHOP WITH NAVIGATOR
WWW.SCHRACK.COM

- Finding product information made easy
- Buying products around the clock
- Quick access customer service

PULSE TIME RELAY ZR5B0025



SCHRACK-INFO

- Asymmetric flasher, 2-time multifu
- 7 Time ranges
- Wide input voltage range
- 2 change-over contacts
- Width 35 mm
- Installation design

TECHNICAL DATA

1. Functions

The function has to be set before connecting the relay to the supply voltage.

| | |
|------|--|
| Ip | Asymmetric flasher pause first |
| li | Asymmetric flasher pulse first |
| ER | ON delay and OFF delay with control contact |
| EWu | ON delay single shot leading edge voltage controlled |
| EWs | ON delay single shot leading edge with control contact |
| WsWa | Single shot leading and single shot trailing edge with control contact |
| Wt | Pulse sequence monitoring |

2. Time ranges

| Time range | Adjustment range | |
|------------|------------------|--------|
| 1 s | 50 ms | 1 s |
| 10 s | 500 ms | 10 s |
| 1 min | 3 s | 1 min |
| 10 min | 30 s | 10 min |
| 1 h | 3 min | 1 h |
| 10 h | 30 min | 10 h |
| 100 h | 5 h | 100 h |

3. Indicators

| | |
|------------------------------|------------------------------|
| Green LED U/t ON: | indication of supply voltage |
| Green LED U/t slow flashing: | indication of time period t1 |
| Green LED U/t fast flashing: | indication of time period t2 |
| Yellow LED ON/OFF: | indication of relay output |

4. Mechanical design

Self-extinguishing plastic housing, IP rating IP40
 Mouted on DIN-rail TS 35 according to EN 50022
 Mounting position: any
 Shockproof terminal connection according to VBG 4 (PZ1 required),
 IP rating IP20
 Tightening torque: max. 1 Nm
 Terminal capacity:
 1 x 0.5 to 2.5 mm² with/without multicore cable end
 1 x 4 mm² without multicore cable end
 2 x 0.5 to 1.5 mm² with/without multicore cable end
 2 x 2.5 mm² flexible without multicore cable end

5. Input circuit

| | |
|------------------------|-----------------------|
| Supply voltage: | terminals A1(+) - A2 |
| Types ZR5B0025 | |
| 12-240 V AC/DC: | 12 to 240 V AC/DC |
| Tolerance: | 12 V-10% to 240 V+10% |
| Rated frequency: | 48 to 63 Hz |
| Rated consumption: | 6 VA (2 W) |
| Duration of operation: | 100% |

| | |
|------------------------|--------------------------------|
| Reset time: | 100 ms |
| Residual ripple of DC: | - |
| Drop-out voltage: | >30% of the supply voltage |
| Overvoltage category: | III (according to IEC 60664-1) |
| Rated surge voltage: | 4kV |

6. Output circuit

| | |
|---------------------------------------|--|
| 2 potential free change over contacts | |
| Rated voltage: | 250 V AC |
| Switching capacity: | 2000 VA (8 A / 250 V) |
| Fusing: | 8 A fast acting |
| Mechanical life: | 20 x 10 ⁶ operations |
| Electrical life: | 2 x 10 ⁵ operations at 1000 VA resistive load |
| Switching frequency: | max. 60/min at 100 VA resistive load max. 6/min at 1000 VA resistive load (according to IEC 947-5-1) |
| Overvoltage category: | III (according to IEC 60664-1) |
| Rated surge: | 4 kV |

7. Control input

| | |
|------------------------------|--------------------------------------|
| Input not potential free: | terminals A1-B1 |
| Loadable: | yes |
| Max. line length: | 10 m |
| Trigger level (sensitivity): | automatic adaption to supply voltage |
| Max. control pulse length: | DC 50 ms / AC 100 ms |

8. Accuracy

| | |
|------------------------|----------------------------|
| Base accuracy: | ±1% of maximum scale value |
| Adjusting accuracy: | ≤5% of maximum scale value |
| Repetition accuracy: | <0.5% or ±5 ms |
| Voltage influence: | - |
| Temperature influence: | ≤0.01% / °C |

9. Ambient conditions

| | |
|------------------------|--|
| Ambient temperature: | -25 to +55 °C (according to IEC 68-1) |
| Storage temperature: | -25 to +70 °C |
| Transport temperature: | -25 to +70 °C |
| Relative humidity: | 15% to 85% (according to IEC 721-3-3 class 3K3) |
| Pollution degree: | 2, if built in 3 (according to IEC 664-1) |
| Vibration resistance: | 10 to 55 Hz 0.35 mm (according to IEC 68-2-6) |
| Shock resistance: | 15 g 11 ms (according to IEC 68-2-27) |

FUNCTIONS

Asymmetric flasher pause first (lp)

When the supply voltage U is applied, the set interval t1 begins (green LED U/t flashes slowly). After the interval t1 has expired, the output relay R switches into on-position (yellow LED illuminated) and the set interval t2 begins (green LED U/t flashes fast). After the interval t2 has expired, the output relay switches into off-position (yellow LED not illuminated). The output relay is triggered at the ratio of t1:t2 until the supply voltage is interrupted.



Asymmetric flasher pulse first (li)

When the supply voltage U is applied, the output relay R switches into on-position (yellow LED illuminated) and the set interval t1 begins (green LED U/t flashes slowly). After the interval t1 has expired, the output relay switches into off-position (yellow LED not illuminated) and the set interval t2 begins (green LED U/t flashes fast). After the interval t2 has expired, the output relay switches into on-position (yellow LED illuminated). The output relay is triggered at the ratio of t1:t2 until the supply voltage is interrupted.

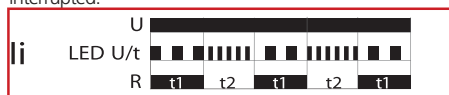

ON delay and OFF delay with control contact (ER)

The supply voltage U must be constantly applied to the device (green LED U/t illuminated). When the control contact S is closed, the set interval t1 begins (green LED U/t flashes slowly). After the interval t1 has expired, the output relay R switches into on-position (yellow LED illuminated). If the control contact is opened, the set interval t2 begins (green LED U/t flashes fast). After the interval t2 has expired, the output relay switches into off-position (yellow LED not illuminated). If the control contact is opened before the interval t1 has expired, the interval already expired is erased and is restarted with the next cycle.



ON delay and single shot leading edge voltage controlled (EWu)

When the supply voltage U is applied, the set interval t1 begins (green LED U/t flashes slowly). After the interval t1 has expired, the output relay R switches into on-position (yellow LED illuminated) and the set interval t2 begins (green LED U/t flashes fast). After the interval t2 has expired, the output relay switches into off-position (yellow LED not illuminated). If the supply voltage is interrupted before the interval t1+t2 has expired, the interval already expired is erased and is restarted when the supply voltage is next applied.

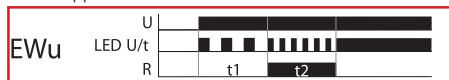

ON delay and single shot leading edge with control contact (EWS)

The supply voltage U must be constantly applied to the device (green LED U/t illuminated). When the control contact S is closed, the set interval t1 begins (green LED U/t flashes slowly). After the interval t1 has expired, the output relay R switches into on-position (yellow LED illuminated) and the set interval t2 begins (green LED U/t flashes fast). After the interval t2 has expired, the output relay switches into off-position (yellow LED not illuminated). During the interval, the control contact can be operated any number of times. A further cycle can only be started when the cycle run has been completed.

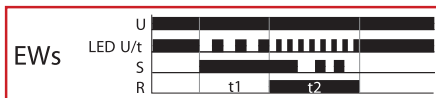

Single shot leading and single shot trailing edge with control contact (WsWa)

The supply voltage U must be constantly applied to the device (green LED U/t illuminated). When the control contact S is closed, the output relay R switches into on-position (yellow LED illuminated) and the set interval t1 begins (green LED U/t flashes slowly). After the interval t1 has expired, the output relay R switches into off-position (yellow LED not illuminated). If the control contact is opened, the output relay again switches into on-position (yellow LED illuminated) and the set interval t2 begins (green LED U/t flashes fast). After the interval t2 has expired the output relay switches into off-position (yellow LED not illuminated). During the interval, the control contact can be operated any number of times.

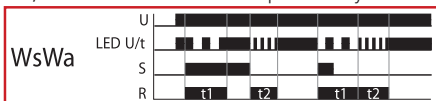

Pulse sequence monitoring (Wt)

When the supply voltage U is applied, the set interval t1 begins (green LED U/t flashes slowly) and the output relay R switches into on-position (yellow LED illuminated). After the interval t1 has expired, the set interval t2 begins (green LED U/t flashes fast). So that the output relay R remains in on-position, the control contact S must be closed and opened again within the set interval t2. If this does not happen, the output relay R switches into off-position (yellow LED not illuminated) and all further pulses at the control contact are ignored. To restart the function the supply voltage must be interrupted and reapplied.

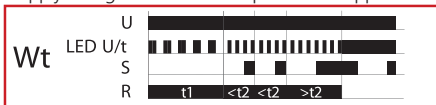

CONNECTIONS

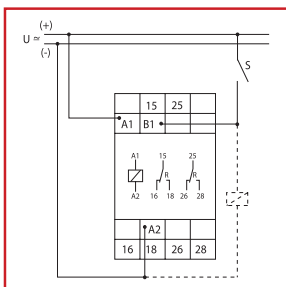

DIMENSIONS

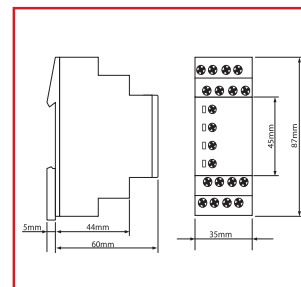

WEIGHT

Single packing: 106g

| DESCRIPTION | EAN CODE | AVAILABLE | ORDER NO. |
|--|---------------|-----------|-----------|
| Pulse time relay, 7 functions, 12-240VAC, 2 change over, 8A/250V | 9004840507263 | | ZRSB0025 |

STAR-DELTA-RELAY ZR5SD025



SCHRACK-INFO

- Star-Delta start up
- 2 change-over contacts
- Wide input voltage range
- Width 35 mm
- Installation design

TECHNICAL DATA

1. Functions

S Star-delta start up

2. Time ranges

Start-up time

| Time range | Adjustment range | |
|------------|------------------|-------|
| 10 s | 500 ms | 10 s |
| 30 s | 1500 ms | 30 s |
| 1 min | 3 s | 1 min |
| 3 min | 9 s | 3 min |

Transit time (fixed)

- 40 ms
- 60 ms
- 80 ms
- 100 ms

3. Indicators

Green LED U/t ON: indication of supply voltage delta-contactor in on-position (terminals 25-28)

Green LED U/t flashes: indication of time period star time

Yellow LED R ON/OFF: indication of star contactor (terminals 15-18)

4. Mechanical design

Self-extinguishing plastic housing, IP rating IP40
 Mounted on DIN-rail TS 35 according to EN 50022
 Mounting position: any
 Shockproof terminal connection according to VBG 4 (PZ1 required), IP rating IP20
 Tightening torque: max. 1 Nm
 Terminal capacity:
 1 x 0.5 to 2.5 mm² with/without multicore cable end
 1 x 4 mm² without multicore cable end
 2 x 0.5 to 1.5 mm² with/without multicore cable end
 2 x 2.5 mm² flexible without multicore cable end

5. Input circuit

Supply voltage: terminals A1(+)-A2
 Type ZR5SD025 12 to 240 V AC/DC
 Tolerance: 12 V-10% to 240 V+10%
 Rated consumption: 4 VA (1.5 W)
 Rated frequency: AC 48 to 63Hz
 Duty cycle: 100%

Reset time: 100 ms
 Residual ripple of DC: 10%
 Drop-out voltage: >30% of the supply voltage
 Overvoltage category: III (according to IEC 60664-1)
 Rated surge voltage: 4 kV

6. Output circuit

2 potential free change over contacts
 Rated surge: 250 V AC
 Switching capacity: 2000 VA (8 A / 250 V)
 Fusing: 8 A fast acting
 Mechanical life: 20 x 10⁶ operations
 Electrical life: 2 x 10⁵ operations

at 1000 VA resistive load
 max. 60/min at 100 VA resistive load
 max. 6/min at 1000 VA resistive load (according to IEC 947-5-1)
 Overvoltage category: III. (according to IEC 60664-1)
 Rated surge voltage: 4 kV

7. Accuracy

Base accuracy: ±1% of maximum scale value
 Adjustment accuracy: <5% of maximum scale value
 Repetition accuracy: <0.5% or ±5 ms
 Voltage influence: -
 Temperature influence: ≤0.01% / °C

8. Ambient conditions

Ambient temperature: -25 to +55 °C (according to IEC 68-1)
 Storage temperature: -25 to +70 °C
 Transport temperature: -25 to +70 °C
 Relative humidity: 15% to 85% (according to IEC 721-3-3 Klasse 3K3)
 Pollution degree: 2, if built in 3 (according to IEC 664-1)
 Vibration resistance: 10 to 55 Hz 0.35 mm (according to IEC 68-2-6)
 Shock resistance: 15 g 11 ms (according to IEC 68-2-27)

TIME RELAYS

FUNCTIONS

Star-delta start up

When the supply voltage U is applied, the star-contact switches into on-position (yellow LED illuminated) and the set star-time t1 begins (green LED U/t flashes). After the interval t1 has expired (green LED U/t illuminated), the star-contact switches into off-position (yellow LED not illuminated) and the set transit-time t2 begins. After the interval t2 has expired, the contact for the delta-contactor switches into on-position. To restart the function, the supply voltage must be interrupted and reapplied.

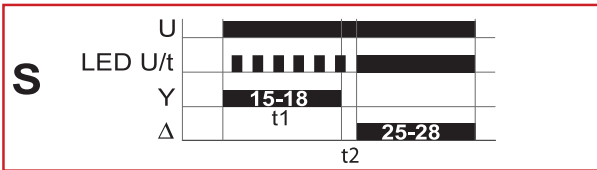

CONNECTIONS

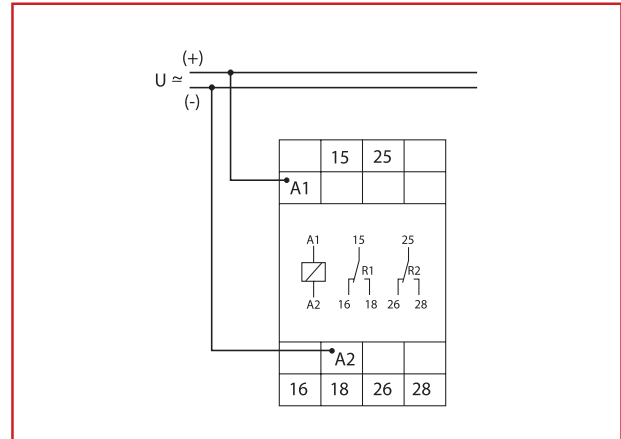

WEIGHT

Single packing: 106 g

DIMENSIONS

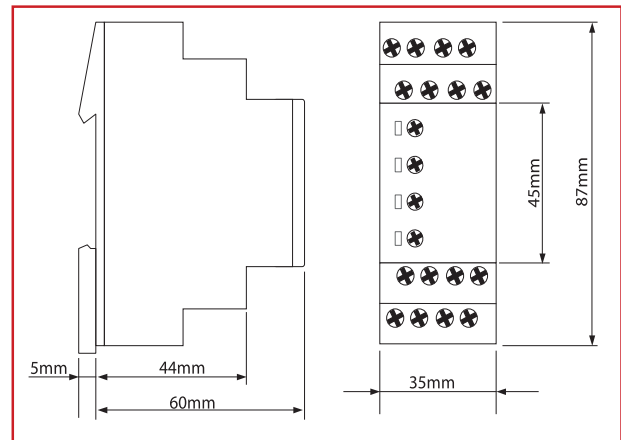

| DESCRIPTION | EAN CODE | AVAILABLE | ORDER NO. |
|--|---------------|-----------|-----------|
| Star-delta-relay, 12-240VAC, 2 change over | 9004840507300 | | ZR5SD025 |



I KNOW WHERE TO FIND IT!

WITH THE SCHRACK TECHNIK LIVE-PHONE APP

- Access technical product information at any time and from everywhere
- See availability and price immediately
- Order desired products easily

STAR-DELTA-RELAY ZR6SD052



- Star-Delta start-up
- Supply voltage selectable via power modules
- 2 change-over contacts
- Width 22.5 mm
- Industrial design

TECHNICAL DATA

1. Functions

S Star-Delta start-up

2. Zeitbereiche

Start-up time

| Time range | Adjustment range | |
|------------|------------------|------|
| 10s | 500ms | 1s |
| 3s | 1500ms | 30s |
| 1min | 3s | 1min |
| 3min | 9s | 3min |

Transit time

Time range (fixed)

40ms
60ms
80ms
100ms

3. Indicators

Green LED ON: indication of supply voltage delta-contactor in on-position (terminals 25-28)

Green LED flashes: indication of star-time

Yellow LED ON/OFF: indication of star-contactor (terminals 15-18)

4. Mechanical design

Self-extinguishing plastic housing, IP rating IP40

Mounted on DIN-Rail TS 35 according to EN 50022

Mounting position: any

Shockproof terminal connection according to VBG 4 (PZ1 required), IP rating IP20

Tightening torque: max. 1Nm

Terminal capacity:

- 1 x 0.5 bis 2.5 mm² with/without multicore cable end
- 1 x 4 mm² without multicore cable end
- 2 x 0.5 bis 1.5 mm² with/without multicore cable end
- 2 x 2.5 mm² flexible without multicore cable end

5. Input circuit

Supply voltage: 12 to 400V AC

Tolerance:

Rated frequency:

Rated consumption:

Duration of operation:

Reset time:

Residual ripple for DC:

Drop-out voltage:

Overvoltage category:

Rated surge voltage:

terminals A1-A2 (galvanically separated) selectable via power modules TR2

according to specification of power module

according to specification of power module

2VA (1.5W)

100%

100ms

-

>30% of the supply voltage

III (in accordance with

IEC 60664-1)

4kV

6. Output circuit

2 potential free change-over contacts

Rated voltage: 250V AC

Schaltleistung: 750VA (3A / 250V AC)

If the *distance* between the devices is *less than 5mm!*

Switching capacity: 1250VA (5A / 250V AC)

If the *distance* between the devices is *greater than 5mm!*

Fusing: 5A fast acting

Mechanical life: 20 x 10⁶ operations

Electrical Life: 2 x 10⁵ operations at 1000VA

resistive load

max. 60/min bei 100VA

resistive load

max. 6/min bei 1000VA

resistive load (in accordance with

IEC 60947-5-1)

Overvoltage category: III (in accordance with IEC 60664-1)

Rated surge voltage: 4kV

7. Accuracy

Base accuracy: ±1% (of maximum scale value)

Frequency response: -

Adjustment accuracy: ≤5% (of maximum scale value)

Repetition accuracy: <0.5% or ±5ms

Voltage influence: -

temperature influence: ≤0.01% / °C

TIME RELAYS

8. Ambient conditions

Ambient temperature: -25 to +55°C
 (in accordance with IEC 60068-1)
 -25 to +40°C
 (in accordance with UL 508)

Storage temperature: -25 to +70°C

Transport temperature: -25 to +70°C

Relative humidity: 15% to 85% (in accordance with IEC 60721-3-3 class 3K3)

Pollution degree: 3 (in accordance with IEC 60664-1)

Vibration resistance: 10 to 55Hz 0.35mm
 (in accordance with IEC 60068-2-6)

Shock resistance: 15g 11ms (in accordance with IEC 60068-2-27)

FUNCTIONS

Star-Delta start-up (S)

When the supply voltage U is applied, the star-contact switches into on-position (yellow LED illuminated) and the set star-time t1 begins (green LED flashing). After the interval t1 has expired (green LED illuminated) the star-contact switches into off-position (yellow LED not illuminated) and the set transit-time t2 begins. After the interval t2 has expired the delta-contact switches into on-position. To restart the function the supply voltage must be interrupted and re-applied.

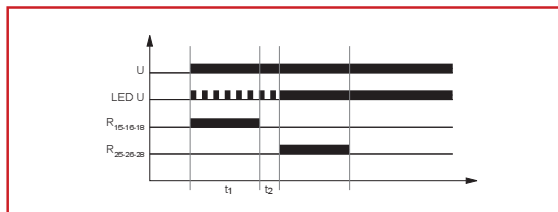

CONNECTIONS

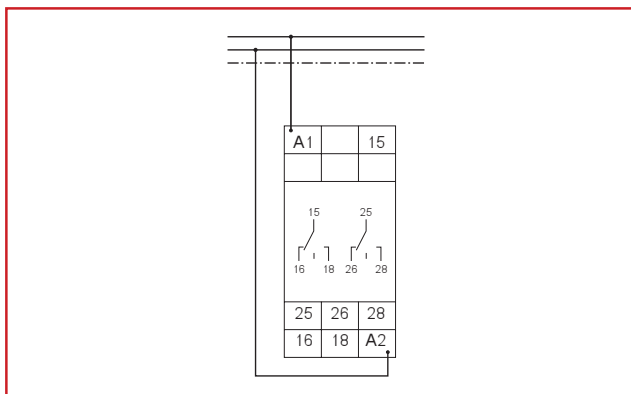

DIMENSIONS

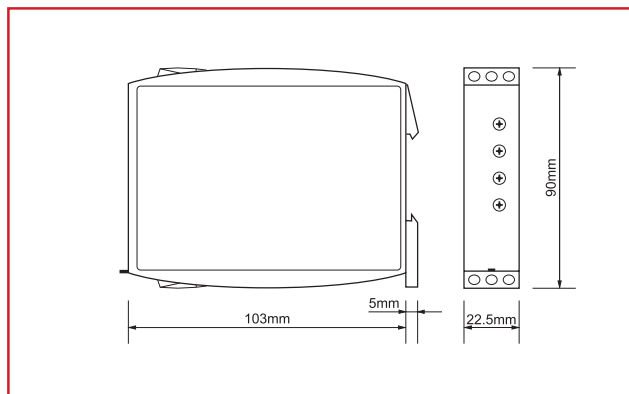

| DESCRIPTION | EAN CODE | AVAILABLE | ORDER NO. |
|--|---------------|-----------|-----------|
| Star-delta-relay, 2 change over, industrial design | 9004840557459 | | ZR6SD052 |



I KNOW WHERE TO FIND IT!

THE SCHRACK TECHNIK WEB SHOP WITH NAVIGATOR
WWW.SCHRACK.COM

- Finding product information made easy
- Buying products around the clock
- Quick access customer service

EMERGENCY LIGHT TEST RELAY ZR5RT011



- Timer for automatic test of emergency lights
- Integrated test key
- 1 change over contact
- Width 17.5 mm
- Installation design

TECHNICAL DATA

1. Functions

Ws Single shot leading edge with control contact

2. Time ranges

Time range reversible between 10min, 30min, 60min, 90min, 2h and 3h

3. Indicators

Green LED U/t ON: indication of supply voltage
 Green LED U/t flashes: indication of time period t
 Green LED U/t flashes fast: abort of time period t
 Yellow LED ON/OFF: indication of relay output

4. Mechanical design

Self-extinguishing plastic housing, IP rating IP 40
 Mounted on DIN-rail TS 35 according to EN 60715
 Mounting position: any
 Shockproof terminal connection according to VBG 4 (PZ1 required), IP rating IP20
 Tightening torque: max. 1Nm
 Terminal capacity:
 1 x 0.5 to 2.5 mm² with/without multicore cable end
 1 x 4 mm² without multicore cable end
 2 x 0.5 to 1.5 mm² with/without multicore cable end
 2 x 2.5 mm² flexible without multicore cable end

5. Input circuit

Supply voltage: 230V AC
 Terminals: L-N
 Tolerance: -15% to +10%
 Rated frequency: 48 to 63Hz
 Rated consumption: 2VA (1.0W)
 Duty cycle: 100%
 Reset time: 500ms
 Ripple and noise at DC: -
 Drop out voltage: >30% of supply voltage
 Overvoltage category: III (in accordance with IEC 60664-1)
 Rated surge voltage: 4kV

6. Output circuit

1 change over contact

NORMALLY OPEN CONTACT

Terminals: L-18
 Rated voltage: 250V AC
 Switching capacity: 1250VA (5A / 250V AC)

NORMALLY CLOSED CONTACT

Terminals: L-16
 Rated voltage: 250V AC
 Switching capacity: 2500VA (10A / 250V AC)
 If the distance between the devices is less than 5mm!

Switching capacity: 4000VA (16A / 250V AC)
 If the distance between the devices is greater than 5mm!
 Start-up peak (20ms): 80A

Mechanical life: 30 x 10⁶ operations
 Electrical life:
 Resistive load: 10⁵ operations at 16A 250V
 Lamp load: 80.000 operations at 1000W 250V

7. Accuracy

Base accuracy: ±5%
 Adjustment accuracy: -
 Repetition accuracy: <2%
 Voltage influence: -
 Temperature influence: ≤1%

8. Ambient conditions

Ambient temperature: -25 to +55°C
 Storage temperature: -25 to +70°C
 Transport temperature: -25 to +70°C
 Relative humidity: 15% to 85% (in accordance with IEC 60721-3-3 class 3K3)
 Pollution degree: 2, if built in 3 (in accordance with IEC 60664-1)

TIME RELAYS

FUNCTIONS

Single shot leading edge with control contact (Ws)

The supply voltage U must be constantly to the device (green LED U/t illuminated). Pressing the integrated test key forces the output relay R to switch into on-position (yellow LED illuminated), so the emergency lights are disconnected from the mains and the set interval t begins (green LED U/t flashes). After the interval t has expired (green LED U/t illuminated), the output relay R switches into off-position (yellow LED not illuminated) and the emergency lights are reconnected to the mains. During the interval, the test key can be operated any number of times. Prolonged pressure on the test key (>2s) aborts the running test interval (green LED U/t flashes fast) and a further cycle can be started.

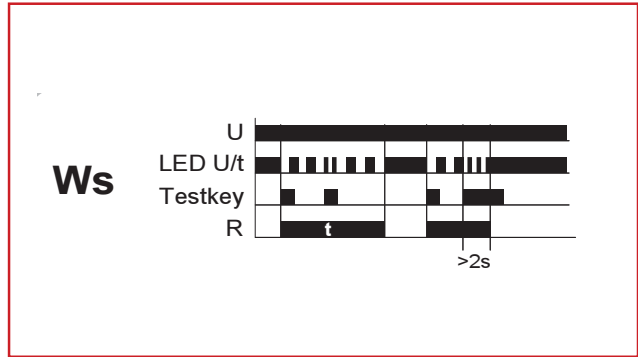

CONNECTIONS

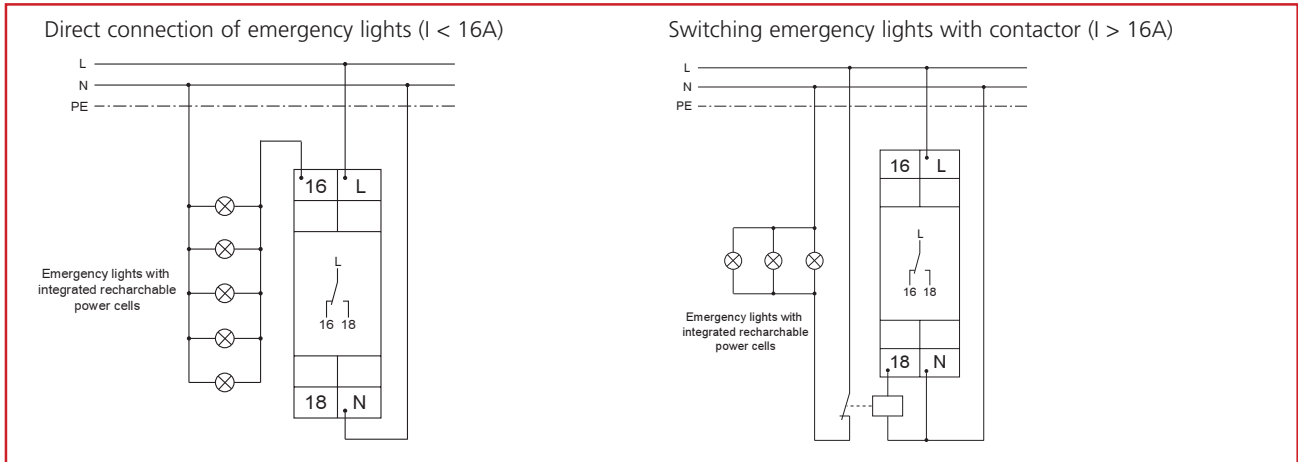

Page
500

DIMENSIONS

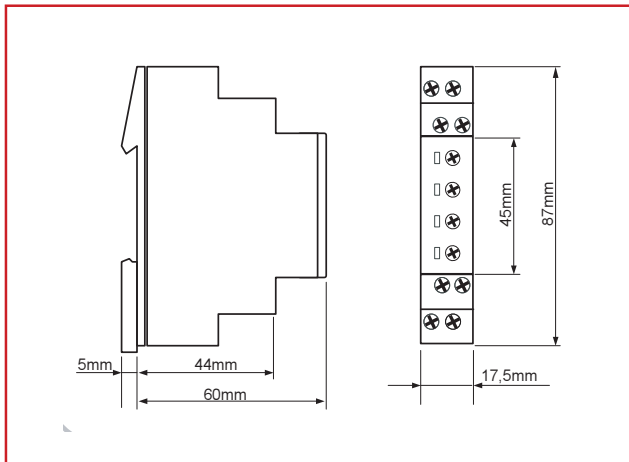

| DESCRIPTION | EAN CODE | AVAILABLE | ORDER NO. |
|----------------------------|--------------|-----------|-----------------|
| Emergency light test relay | 900484057374 | | ZR5RT011 |