

Sunco

Lighting made better.

User Manual

7" LED Prismatic Lens

Wraparound Light

SKU: WR_PR7-WH-4060K

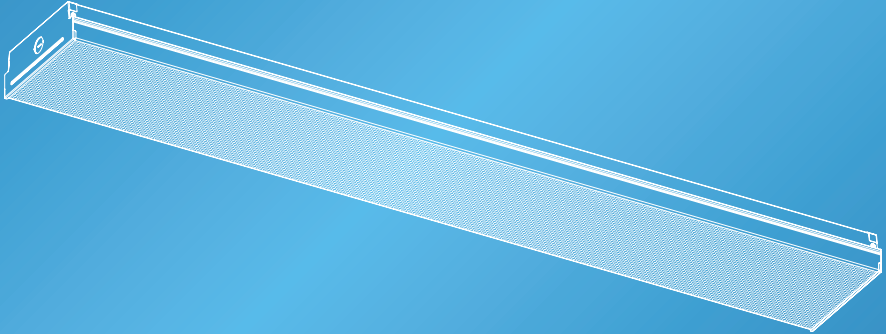

support@sunco.com
(844) 334-9938



AMERICAN
COMPANY

Whats in the Box?

Wraparound

*Let there be light!
(literally)*

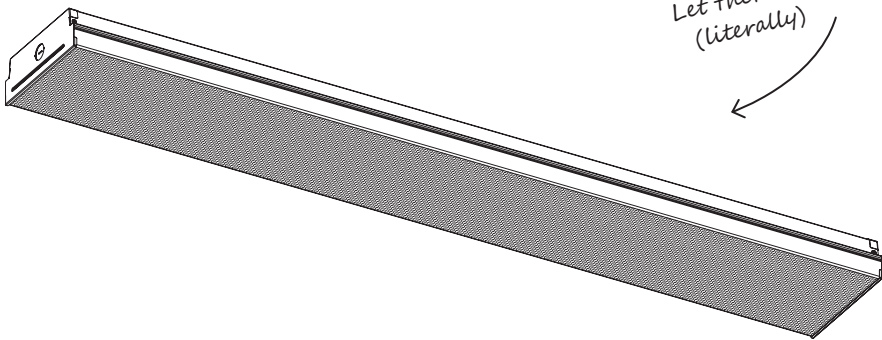

Components



x1

Light Fixture



x2

Screws(15mm) #8 - 32



x4

Wood Screws ST4



x3

Heat-shrink Tube Φ 12



x3

Wire Nuts (P3)

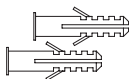

x4

Wall Anchors

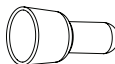

x3

Wire Connectors (CE5)



x4

Inner Toothed Washer

Before You Start

Safety Information

To reduce the risk of fire, electric shock, or physical injury:

- Turn off power before changing fixture.
- Suitable for use in damp environments at temperatures ranging from -4°F to 104°F. Not for use where directly exposed to water.
- Not intended for use with emergency fixtures.
- Not compatible with photo-electric sensors.
- Not compatible with motion sensors.
- Not compatible with third party sensors.
- Not compatible with dimmers. For more dimming information, please visit www.sunco.com.
- Not compatible with timing devices.
- All electrical connections must be in accordance with local and National Electric Code (N.E.C.) standards.
- Please review installation manual carefully before proceeding. Consult a qualified electrician if you are unfamiliar with proper electrical wiring connections.

⚠ WARNING:
Cancer & Reproductive Harm- www.P65Warnings.ca.gov

This device complies with Part 15 of the FCC rules. Operation is subject to the following two conditions:
1.) This device may not cause harmful interference.

2.) This device must accept any interference that may cause undesired operation. Please review all instructions carefully prior to installation.

Quickstart Guide



Step 1

Label wires when replacing fixtures.

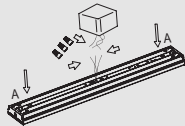

Step 2

Screw (AA) into junction box, leaving 1/4" exposed.

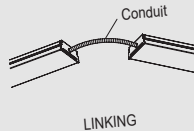

Step 3

Press for secure, audible "click."

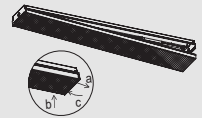

Step 4

Reattach diffuser & secure with aluminum base.

Installation Guide (Junction Box Installation)

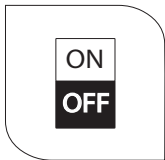

STEP 1

- a. Turn off circuit breaker before installation.
- b. For fixture replacement, sketch or label wires for reference.

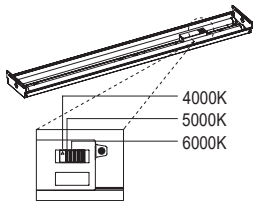

STEP 2

- a. Remove the diffuser from the lamp base.
- b. Select desired color temperature and brightness.

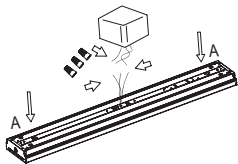

STEP 3

- a. Screw (AA) into junction box, leaving 1/4" exposed for lamp.
- b. In the junction box, connect wires:
Live (black) to Live ; Neutral (white) to Neutral ; Ground (yellow/
green) to Ground. Secure with wire nuts and tuck into the box.

Installation Guide (Cont.)

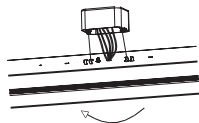

STEP 4

- a. Align Lamp Base holes with junction box screws.
- b. Rotate Lamp Base clockwise to secure it, and tighten screws for fixture stability.

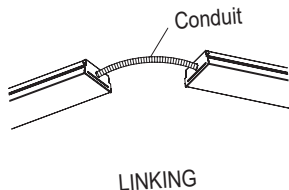

STEP 5

- a. Punch an end cap hole, remove cables from the lamp base, and connect wires: Live (black) to Live, Neutral (white) to Neutral, Ground (yellow/green) to Ground.
- b. The wiring between the fixtures is clamped with a wire connectors to ensure that the clamping is not loose, and then put on the heat shrink tube to tighten.
- c. Size of conduit ≤ 1 inch ($1/2$ " $3/4$ " 1 ")

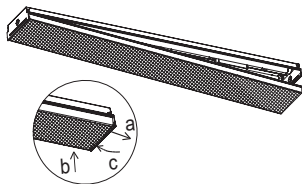

STEP 6

- a. Reattach the diffuser (cover): Align one end and gently press down. Push the diffuser to the corner of the lamp base. Secure the diffuser with the aluminum base.
- b. Restore power by turning on the circuit breaker and test the light.

Installation Guide (Keyhole Installation)

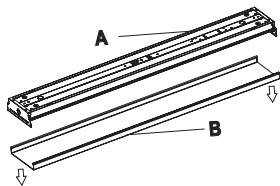

STEP 1

- Turn off circuit breaker before installation.
- For fixture replacement, sketch or label wires for reference.
- The mounting surface must support the fixture's weight. Detach the diffuser from the lamp base.

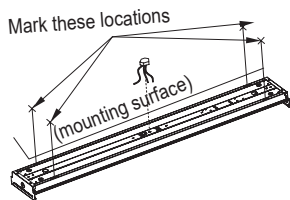

STEP 2

- Choose your preferred color temperature and brightness.
- Align the Lamp Base with the mounting location using the knockout holes. Mark the 4 keyhole slots at each end of the housing.

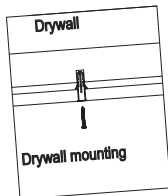

STEP 3

DRYWALL MOUNTING (No Stud):

Drill 4 small pilot holes with a 7/32" bit (not included). Insert wall anchors with a hammer. Partially tighten 4 wood screws, leaving a 3/8" gap between the screw head and the mounting surface.

Installation Guide (Cont.)

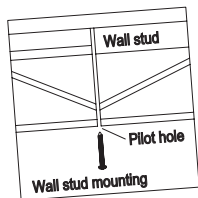

STEP 4

a. WALL STUP MOUNTING OPTION

Drill 4x small pilot holes with a 9/64" drill bit (not included). Install 4x wood screws into the mounting surface, but not fully. Leave about a 3/8" gap between the screw head and mount surface.

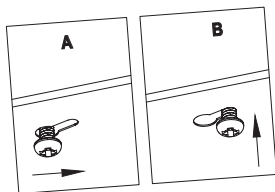

STEP 5

a. Take out the cables from the lamp base. Remove shrink wrap, connect wires: Live (black) to Live, Neutral (white) to Neutral, Ground (yellow/green).

b. Insert screws into keyhole slots, slide lamp base (a) to align screw heads, and secure fixture to mounting surface. Use provided washer for added vibration protection.

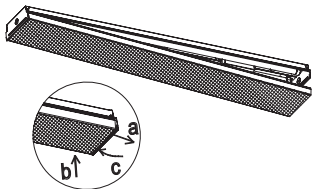

STEP 6

a. Reattach the diffuser, align and secure with metal base. Restore power and test the light.

b. Turn on circuit breaker and the test light.

Product Details

Dimensions

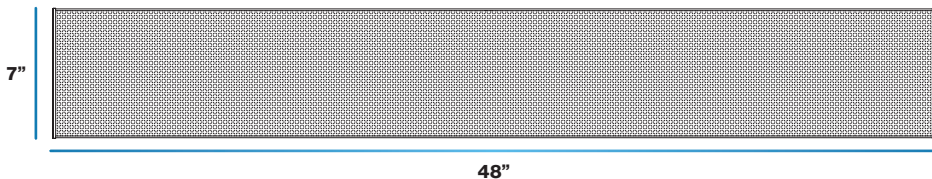

Specifications

Voltage	120V-277V	Average Lifetime	50000 hrs
Wattage	50W	Lumens	6500LM
Power Factor	0.7	Temperature	-4°F to 104°F
Amps	0.495Am	CRI	80+
CCT	4000K/5000K/6000K	Efficacy	130lm/w
Housing Material	PC+Steel	Usage	Indoor
Dimmable	Non-dimmable	Warranty	7 Years

Common Troubleshooting

Feeling in the dark about an issue with your product? No worries! Our troubleshooting section is here to shed some light and provide you with easy-to-follow solutions for any problem.

If you still need some assistance, please feel free to contact us with any questions. Our team of lighting experts are happy to help brighten your day.

Installation

Light isn't turning on.

Double check if fixture is properly connected and circuit breaker hasn't been tripped.

Light unexpectedly fails.

For further assistance, reach out to customer support.

Dimming

Light not dimming to lowest setting.

Light not dimmer compatible.

Light not dimming smoothly.

Light not dimmer compatible.

Light not compatible with dimmer switch.

Light not dimmer compatible.

Flickering

Light is flickering when turning on.

Check that fixture wiring connections are secure.

Light flickering with other lights on the same circuit.

Check that the lights on the same circuit are not overloading the circuit.

Light flickering when turned on.

Verify fixture compatibility and that it is grounded.

Light flickering when dimmed.

Light not dimmer compatible.

Buzzing

Fixture buzzing with power outages.

Verify light is connected to surge protector securely.

Fixture buzzing with appliances or electronic devices.

Look for nearby interferences that can cause buzzing. Such as televisions, radios, computers, etc.

Fixture buzzing when dimmed.

Light not dimmer compatible.

Light Distribution Angle

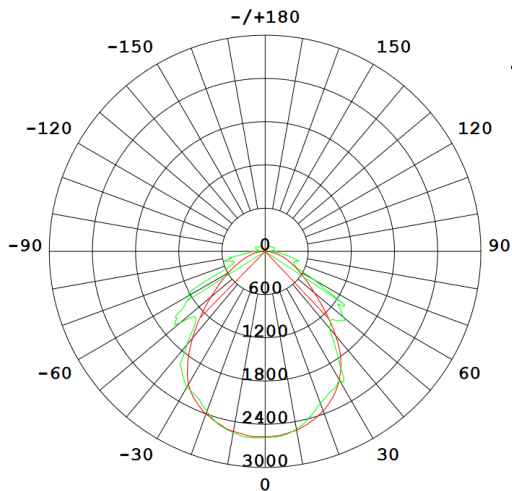

*Not a lighting nerd?
No worries, you can skip this page*

AVERAGE BEAM ANGLE (50%): 101.0 DEG

—	CO/180	88.0°
—	C90/270	113.9°

UNIT:cd Luminous Intensity Distribution 1

Lighting distribution angle refers to the spread of light emitted from a light source. It is an important factor to consider when selecting a fixture or bulb, as it affects the way it will illuminate an area. There are two main types of lighting distribution angles:

A symmetric lighting distribution emits light evenly in all directions, creating a cone-shaped pattern that provides a pool of light. This type of lighting is ideal for general lighting and illuminating large areas. Common applications for symmetric lighting include general area illumination, security lighting, and perimeter lighting. Symmetric lighting is also used to a certain degree in up-lighting.

An asymmetric lighting distribution angle, also known as beam angle, creates a pattern that focuses light in a specific direction. This type of lighting is ideal for task lighting as it reduces glare and light spill in other areas. Common applications include task lighting in spaces such as landscape settings, retail stores, museums, and much more.

It is important to note that the lighting distribution angle can also be affected by other factors such as the reflector design of the light source, the type of lens used, and the distance between the light source and the surface being illuminated.

Warranty Policy

This product is covered by our industry leading 7 year warranty.

It gets even better - scan the QR code for 2 extra years of protection!



Scan me for two extra years!

30 Day Return Policy

At Sunco, we value our customers and stand by the quality and performance of our products.

If you are not completely satisfied with your purchase, we accept returns within 30 days of your purchase date.

Customer Service

Our Los Angeles team of lighting experts is here to assist you with all your needs! Contact us at:

Email: support@sunco.com

Call or Text: (844) 334-9938

Sunco

Lighting made better.

support@sunco.com
(844) 334-9938

REV1.0



AMERICAN
COMPANY