

LED SPEC-SELECT™ VAPOR TIGHT

INSTALL INSTRUCTIONS

PLEASE FIND A QUALIFIED ELECTRICIAN FOR INSTALLATION. Please read the instructions before you install and use the luminaire.
WARNINGS, CAUTIONS AND OPERATING INSTRUCTIONS

- To reduce the risk of death, personal injury or property damage from fire, electric shock, falling parts, cuts/abrasions, and other hazards read all warnings and instructions included with and on the fixture box and all fixture labels.
- Before installing, servicing, or performing routine maintenance upon this equipment, follow these general precautions.
- Commercial installation, service and maintenance of luminaires should be performed by a qualified licensed electrician.
- For the installation: If you are unsure about the installation or maintenance of the luminaires, consult a qualified licensed electrician and check your local electrical code.
- To prevent wiring damage or abrasion, do not expose wiring to edges of sheet metal or other sharp objects.
- Do not make or alter any open holes in an enclosure of wiring or electrical components during kit installation.

WARNING: RISK OF FIRE OR ELECTRICAL SHOCK

- Turn off electrical power at fuse or circuit breaker box before wiring fixture to the power supply.
- Turn off the power when you perform any maintenance.
- Verify that supply voltage is correct by comparing it with the luminaire label information.
- All wiring connections should be capped with UL approved wire connectors.

CAUTION: RISK OF INJURY

- Avoid direct eye exposure to the light source while it is on.
- Account for small parts and discard packing material, as these may be hazardous to children.
- Risk of burn. Disconnect power and allow fixture to cool before handling fixture.

NOTICES:

- Green ground screw provided in proper location. **DO NOT RELOCATE.**
- Use minimum 194°F supply conductors.
- Suitable for Wet Locations.

⚠ WARNING - TURN OFF POWER SUPPLY FROM MAIN CIRCUIT BREAKER BEFORE INSTALLING OR SERVICING.

GENERAL WIRING DIAGRAM

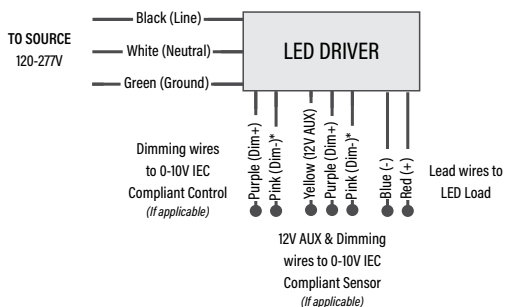

**Per NEMA rule-change Dim (-) control wires changed from gray to pink after Jan. 01, 2022.*

Note: If not connecting to an external 0-10V dimmer circuit, make sure fixture's 0-10V pink and purple leads are capped off separately. Failure to do so may cause fixture to perform incorrectly, and void warranty.

FIELD ADJUSTABLE WATTAGE & CCT

The end users may adjust the color temperature and lumen output, respectively, by the two slide switches integrated into the driver. Each switch has 3 options (left, middle and right), each position corresponds to 3 color temperatures (3500K, 4100K, and 5000K) and 3 wattages, which can be adjusted to the desired combination.

1. Switches are located on the driver.
2. Select a wattage and color temperature by sliding switch left or right respectively to the desired value.

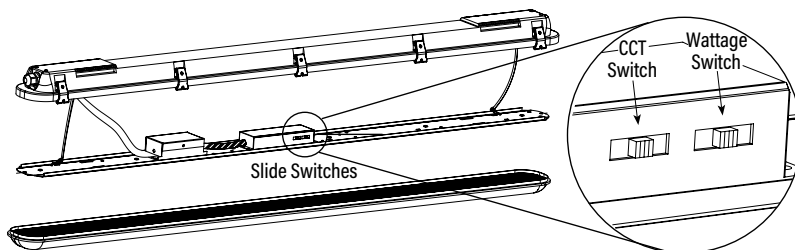

LED SPEC-SELECT™ VAPOR TIGHT

INSTALL INSTRUCTIONS

⚠ WARNING - TURN OFF POWER SUPPLY FROM MAIN CIRCUIT BREAKER BEFORE INSTALLING OR SERVICING.

SURFACE MOUNT INSTALLATION

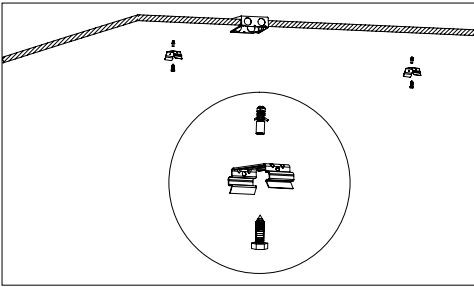

1. Locate drill holes for mounting brackets. Use hardware found in hardware kit. Mount bracket to surface.

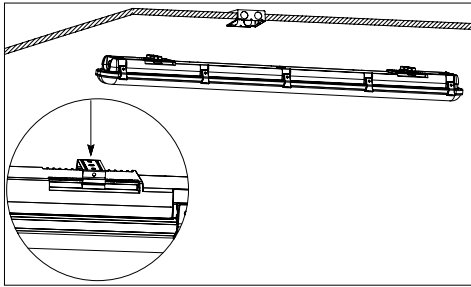

2. Secure mounting clips to housing recesses by firmly pressing them into place until both sides of the clip are secured.

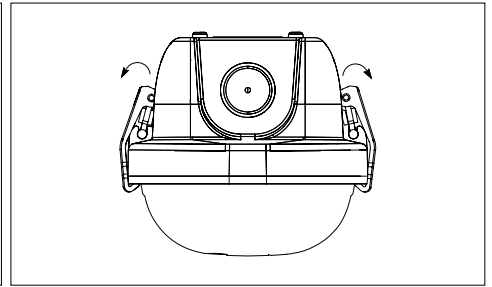

3. Release latches by pulling top of latch away from housing.

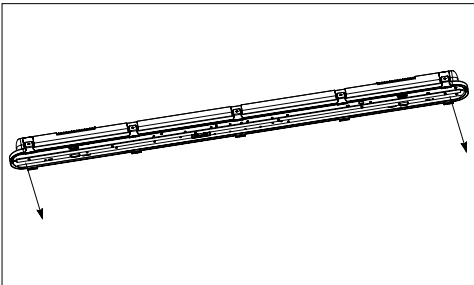

4. Without touching LED boards, detach LED tray from fixture.

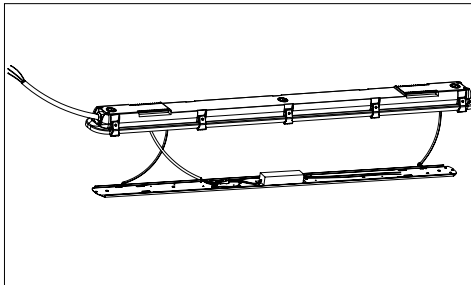

5. Connect power to driver as shown. (Flexible cord supplied by installer)

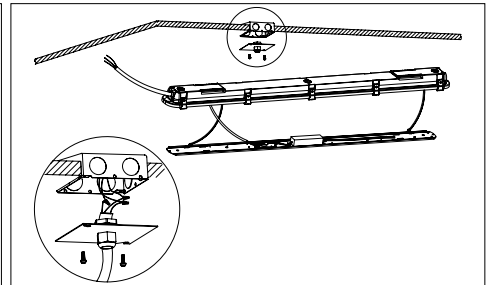

6. Follow general wiring diagram. Make sure the power supply is disconnected before installing.

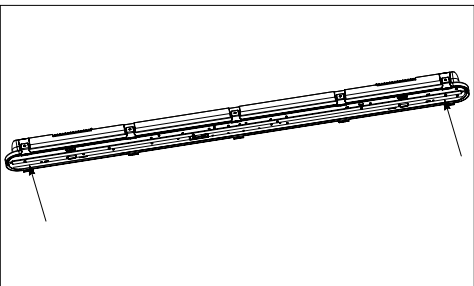

7. Reattach LED tray to fixture by reversing step 4.

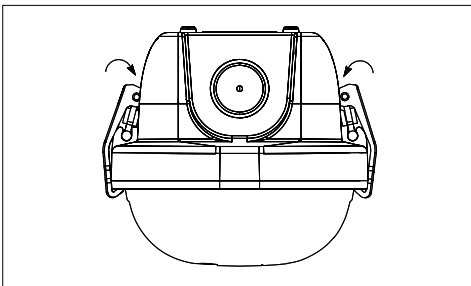

8. Secure lens to housing with lens latches.

Note:

- Connect to power using flexible cord (SJTW 18AWG, not included) to the driver input wires.
- Use the included wet-location-rated strain relief fitting for running the flexible cord through the knockout in the fixture.
- If there are any gaps at the fixture housing after connection, be sure to seal them up with waterproofing silicone glue or sealant.

CHAIN SUSPENDED MOUNT INSTALLATION *(V-Hooks and Chain sold separately)*

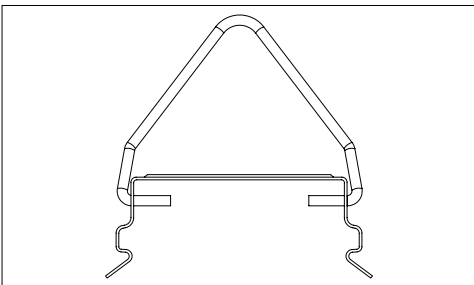

1. Attach V-bracket to each mounting clip by spreading the ends of the V-bracket apart and then inserting the legs into the holes in the side of the mounting clips.

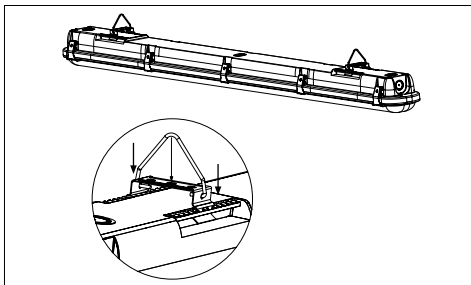

2. Secure mounting clips to housing recesses by firmly pressing them into place until both sides of the clip are secured.

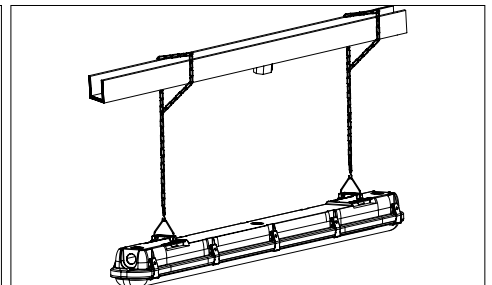

3. Hang fixture from chain using V-brackets. (Chain supplied by installer)

LED SPEC-SELECT™ VAPOR TIGHT

INSTALL INSTRUCTIONS

⚠ WARNING - TURN OFF POWER SUPPLY FROM MAIN CIRCUIT BREAKER BEFORE INSTALLING OR SERVICING.

CHAIN SUSPENDED MOUNT INSTALLATION (cont'd)

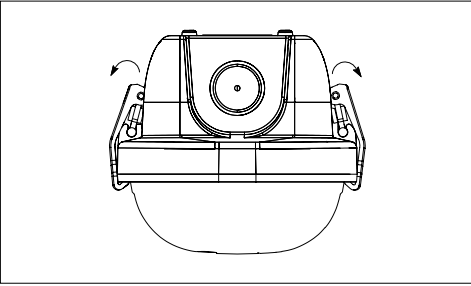

4. Release latches by pulling top of latch away from housing.

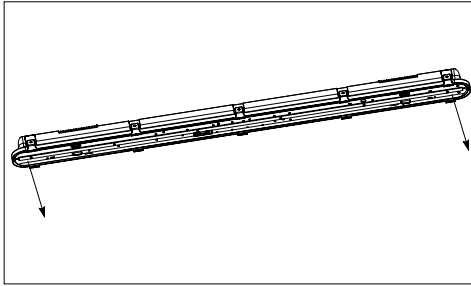

5. Without touching LED boards, detach LED tray from fixture.

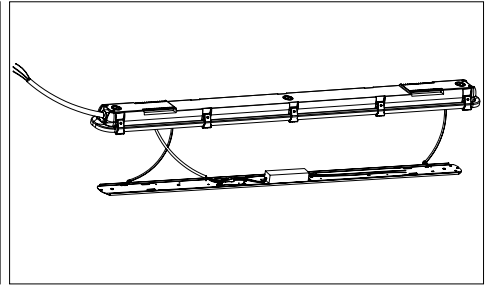

6. Connect power to driver as shown. (Flexible cord supplied by installer)

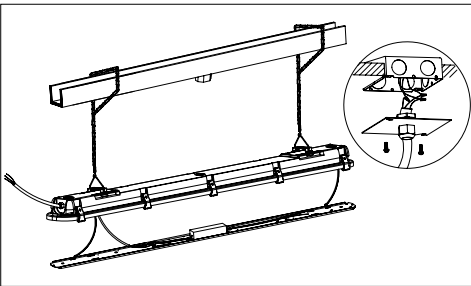

7. Follow general wiring diagram. Make sure the power supply is disconnected before installing.

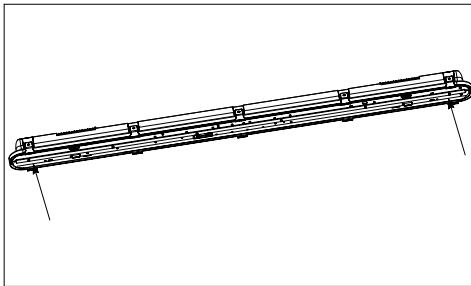

8. Reattach LED tray to fixture by reversing step 5.

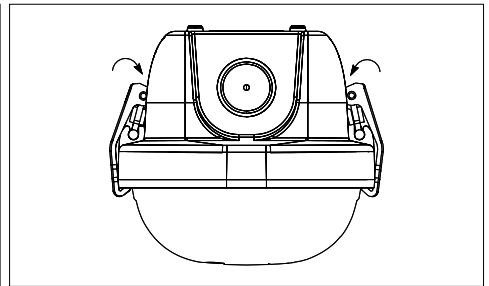

9. Secure lens to housing with lens latches.

FIXTURES W/ISO - INTEGRATED SENSOR

OPTION (If applicable, sensor and elbow sold separately)

For fixtures, with an integrated sensor socket.

1. Remove sensor socket cover. (Fig. 1)
2. Install elbow connector by screwing in clockwise until firmly seated. Once firmly installed, elbow socket can be carefully adjusted to desired position. (Fig. 2)
3. Install sensor by screwing in clockwise until firmly seated. (Fig. 3 & 4)

Note: If you move the sensor to a different location on the fixture, use waterproof knockout plug to cover original sensor hole.

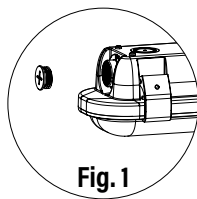
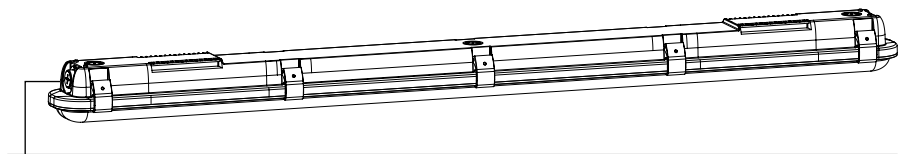

Fig. 1

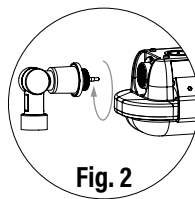

Fig. 2

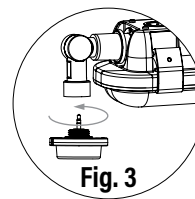

Fig. 3

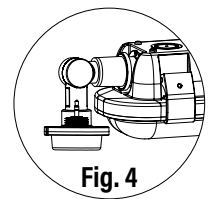

Fig. 4