

ALH AREA LIGHT Installation Instruction



Please read this manual carefully before using the product

⚠ WARNING / ADVERTENCIA / AVERTISSEMENT

To reduce the risk of electrical shock, fire, or injury to persons; read and follow all warnings and installation instructions before installing. All installation should be performed by a qualified electrician.

Rick of Electrical Shock
Ensure power is off before installation or inspection. All wirings are performed in accordance with Electrical Code and local electrical code.

Risk of Fire
Fixtures are rated for use in 120-277V, 50-60Hz protected circuit and 90°C rated supply wire.

Para reducir el riesgo de descarga eléctrica incendio o lesiones a personas, lea y siga todas las advertencias e instrucciones de instalación antes de realizarla. Toda instalación debe ser efectuada por un electricista cualificado.

Riesgo de descarga eléctrica
Asegúrese de desconectar la corriente antes de la instalación o inspección. Todos los cableados se realizan de acuerdo con el Código Eléctrico y el código eléctrico local.

Riesgo de incendio
Las luminarias están clasificadas para su uso con 120-277V, circuitos protegidos de 50-60 Hz y cables adecuados para 90°C.

Lisez et suivez les instructions d'installation et les avertissements avant l'installation. Toute l'installation doit être exécutée par un électricien qualifié, pour réduire les risques de choc électrique, de feu ou de blessures corporelles.

Risque de choc électrique
Assurez-vous que le courant soit coupé avant l'installation ou l'inspection et que tout le câblage soit effectué en conformité avec le code d'électricité et le code local d'électricité.

Risque de feu
Les luminaires sont conçus pour une utilisation de 120 à 277V, pour un circuit protégé de 50 à 60 Hz et pour une source d'alimentation de 90 °C.

FOR YOUR SAFETY
Gloves and safety glasses should be worn while performing the installation.

PARA SU SEGURIDAD
Se deben usar guantes y gafas de seguridad mientras se realiza la instalación.

POUR VOTRE SÉCURITÉ
Des gants et des lunettes de sécurité doivent être portés lors de l'installation.

Any alteration or modification of this product is expressly forbidden as it may cause serious personal injury, death, property damage and/or product malfunction.

Cualquier alteración o modificación de este producto está prohibido expresamente, ya que puede causar graves lesiones personales, muerte, daños a la propiedad y/o mal funcionamiento del producto.

Toute aletération ou modification de ce produit est expressément interdite car elle peut causer des blessures graves, la mort, des dégâts matériels et / ou un dysfonctionnement du produit.

To prevent product malfunction and/or electrical shock, this product must be properly grounded.

Para evitar el mal funcionamiento del producto y/o descargas eléctricas, este producto debe estar correctamente conectado a tierra.

Pour éviter tout dysfonctionnement du produit et / ou un choc électrique, ce produit doit être correctement mise à la terre

To prevent wiring damage or abrasion, do not expose wiring to edges of sheet metal or other sharp objects.

Para evitar daños en el cableado o abrasiones, no exponga el cableado a hojas de metal laminado u otros objetos cortopunzantes.

Pour prévenir les dommages ou l'abrasion, ne pas mettre en contact le câblage avec des bords de plaques de metal ou tout autre objet coupant.

Do not alter, relocate, or remove wiring, lamp-holders, power supply, or any other electrical component.

No altere, reubique o elimine cables, portalamparas, tomacorriente o cualquier otro componente eléctrico.

Ne pas modifier, délocaliser ou enlever du câblage, des supports de lampes, une source d'alimentation ou tout autre composant électrique.

SUITABLE FOR WET LOCATIONS.

APTO PARA LUGARES HÚMEDOS.

CONVIENT AUX ENDROITS HUMIDES.

INSTALLATION / INSTALACIÓN

Disconnect the power before installation. Exploded view of completed assembly with component call out. 1,2,3,etc. Desconecte la alimentación antes de la instalación, Vista de despiece del conjunto completo con indicación de componentes. 1.2.3.etc. Débranchez l'alimentation avant l'installation. Vue en éclaté de l'assemblage complet, avec le nom des composants. 1,2,3,etc.

INSIDE THE BOX

Area Light (Shorting Cap or Twist lock Photocell is optional)

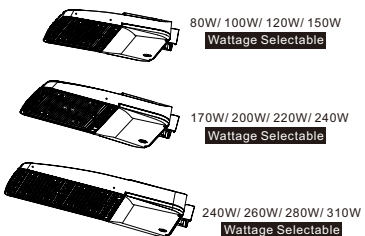

with one of the mounting arms

Mounting Arm

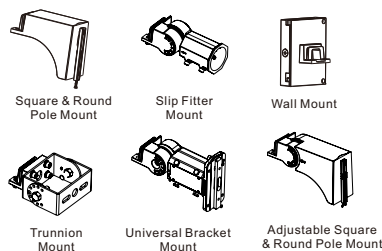

Photocell Quick-install

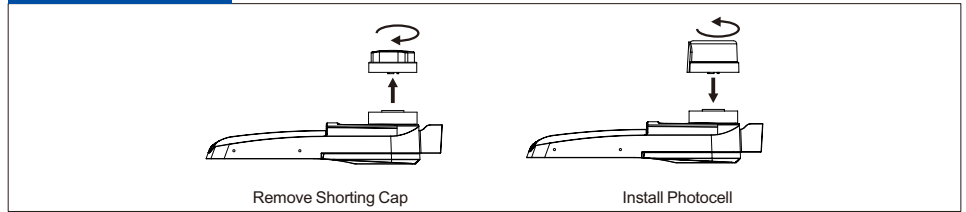

Square & Round Pole Mount

Step1: Unscrew the screws of the iron bar with a screwdriver, adjust the hole spacing of the iron bar in advance according to the hole position on the Square or Round Pole. Remove the junction box cover of the Pole Mount bracket.

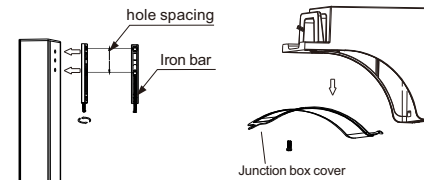

Step2: Fix the iron bar to the inside of the light pole with screws (**Note:** the screw is only screwed into 1/3 of its length), and lead out the input wire.

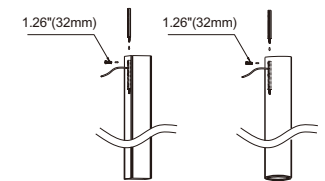

Step3: Pass the rubber gasket and the Pole Mount bracket through the screw and input wire on the light pole. Tighten the screw and then lock the other screw.

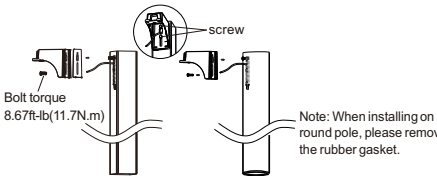

Step3: Run the fixture's AC input wire through the bracket. Hang the fixture on the bracket, and tighten the screws.

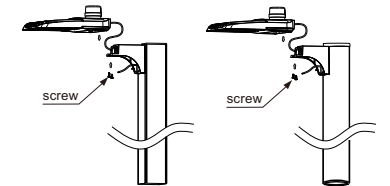

Step 5: Pull the fixture's input wire through the wiring hole into the pole and connect the wires inside or pull the wires out from the access panel on the extrusion arm bracket to connect the wires. Close the pole's top cover or extrusion arm bracket panel.

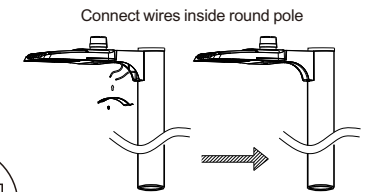
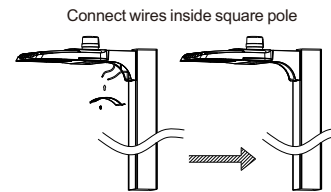

Connect wires inside mounting bracket

Connect wires inside mounting bracket

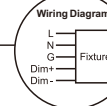
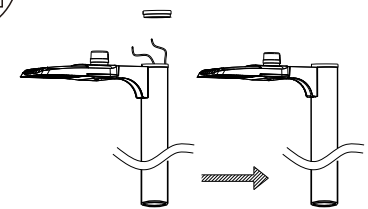
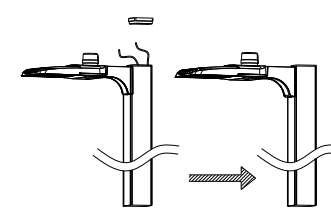

ALH AREA LIGHT Installation Instruction

Please read this manual carefully before using the product

Slip Fitter Mount

Step 1: Disassemble the Slip Fitter with a wrench.

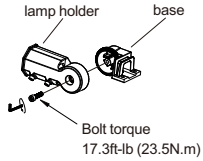

Step 2: Run the fixture's AC input wire through the base, then tighten screws to attach the base to the fixture housing.

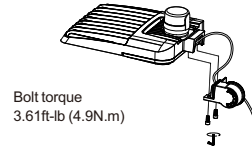

Step 3: Run the fixture's input wire through the lamp holder and lock it.

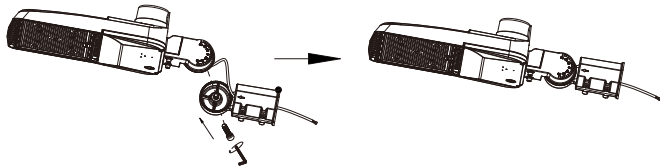

Step 4: Loosen the 4 locking bolts on the Slip Fitter with a wrench.

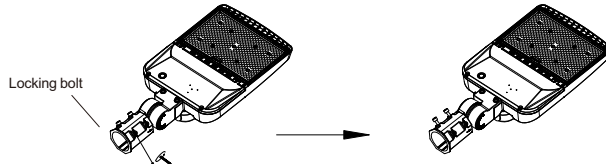

Step 5: Connect the fixture's AC input wire to pole-wire with connectors, L to L(black), N to N(White), G to G(Green); If need to connect dimming wires, please also use the connector to connect "Dim+"(purple)to "Dim +"(purple), "Dim-"(gray) to "Dim-"(gray).

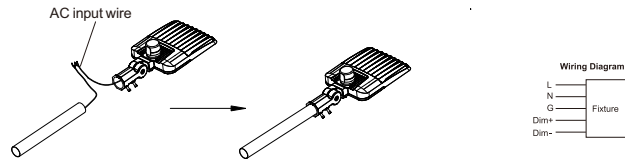

Step 6: Tighten the 4 locking bolts.

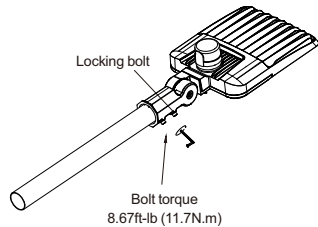

Step 7: Loosen the locking bolt on the Slip Fitter with a wrench to adjust the fixture mounting angle, then tighten the locking bolts. Adjustable angle range $\pm 90^\circ$.

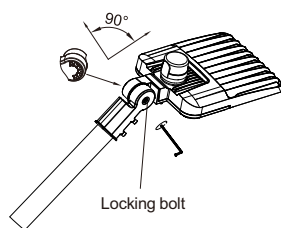

Wall Mount

Step 1: Unscrew the screws of the front cover and remove the front cover.

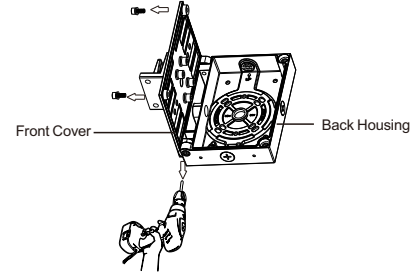

Step 2: Install the back housing directly to the wall using the wall anchor holes and appropriate screws.

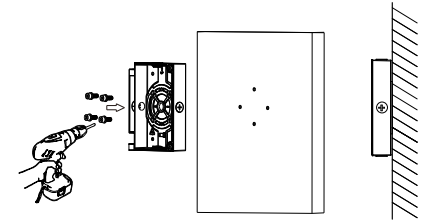

Step 3: Connect the front case set to the back housing and tighten the screws. Hang the fixture on the Wall Mount bracket and tighten screws.

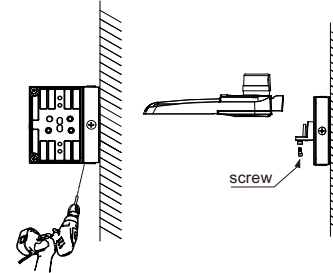

Step 4: Complete wiring in the wall mount bracket, close the front cover and tighten the 2 screws in the front case.

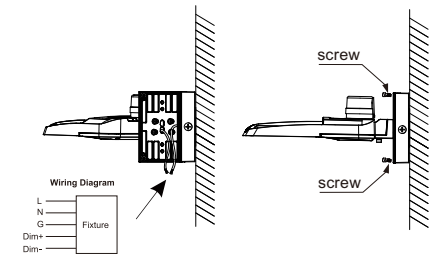

Trunnion Mount

Step 1: Loosen the screws on both sides of the bracket with a wrench, adjust Trunnion Mount bracket's angle to keep parallel with its installation surface.

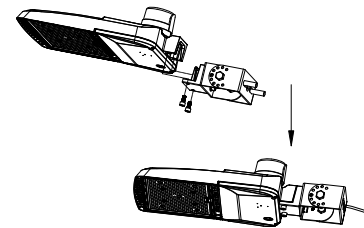

Step 2: Mark the fixing holes locations on the wall with Trunnion Mount bracket, then drill the hole in 10mm diameter with an electric drill.

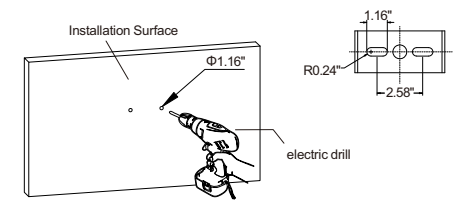

ALH AREA LIGHT Installation Instruction

Please read this manual carefully before using the product

Step 3: Knock the two expansion bolts (not included) into wall with a hammer.

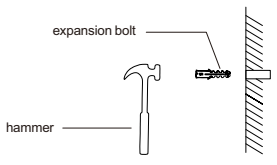

Step 4: Install the Trunnion Mount bracket to the wall with expansion screw by tightening the nut with a wrench. Connecting fixture AC input wire to L N G, then make waterproof processing to joints, put wires into junction box.

Note: The adjustable angel range is 0-180°.

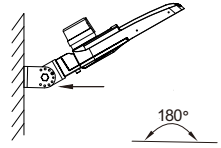

Wiring Diagram

L	—	Fixture
N	—	Fixture
G	—	Fixture
Dim+	—	Fixture
Dim-	—	Fixture

Universal Bracket Mount

Step 1:

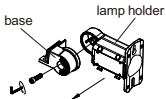

Disassemble the Slip Fitter with a wrench.

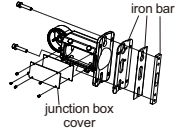

Unscrew the screws, remove the iron bar, open the junction box cover.

Step 2: Run the fixture's AC input wire through the base, then tighten screws to attach the base to the fixture housing.

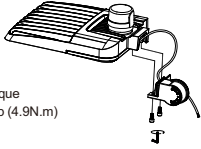

Bolt torque 3.61ft-lb (4.9N.m)

Square & Round Pole Mount

Step 3: Put the iron bar inside of pole, fix it with a screw, but reserve gaps of 32mm, pass the Pole Mount bracket through the screw and hang it on the screw, tighten this screw, pass the 2nd screw through the holes of Pole Mount bracket, pole and iron bar, then tighten it with a wrench.

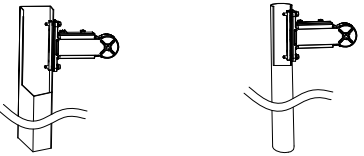

Note: When installing on a round pole, please remove the rubber gasket.

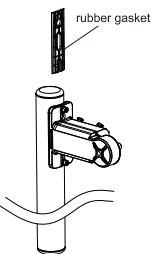

Step 4: Loosen the locking bolt on the Slip Fitter with a wrench to adjust the fixture mounting angle, then tighten the locking bolts. Adjustable angle range $\pm 90^\circ$.

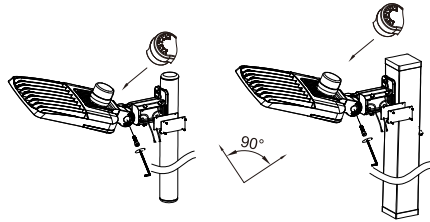

Step 5: Pull the fixture's input wire through the wiring hole into the pole and connect the wires inside or pull the wires out from the access panel on the extrusion arm bracket to connect the wires. Close the pole's top cover or extrusion arm bracket panel.

Connect wire inside round pole

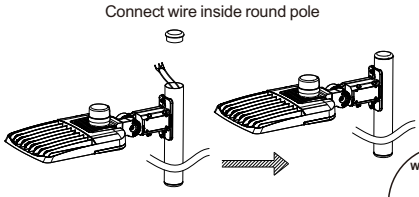

Connect wire inside square pole

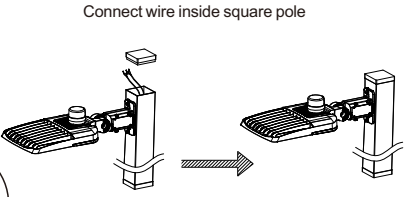

Connect wire inside mounting bracket

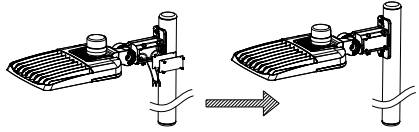

Connect wire inside mounting bracket

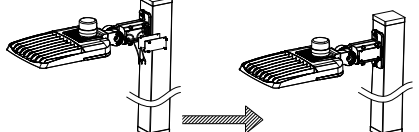

Wiring Diagram

L	—	Fixture
N	—	Fixture
G	—	Fixture
Dim+	—	Fixture
Dim-	—	Fixture

Slip Fitter Mount

Step 1:

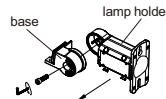

Disassemble the Slip Fitter with a wrench.

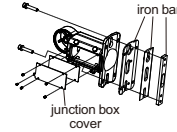

Unscrew the screws, remove the iron bar, open the junction box cover.

Step 2: Run the fixture's AC input wire through the base, then tighten screws to attach the base to the fixture housing.

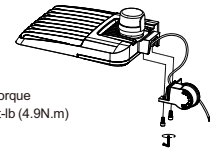

Bolt torque 3.61ft-lb (4.9N.m)

Step 3: Run the fixture's input wire through the lamp holder and lock it.

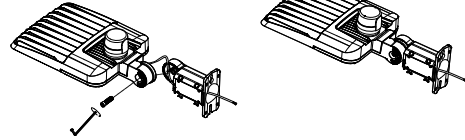

Step 4: Connect the fixture's AC input wire to pole-wire with connectors, L to L (black), N to N (White), G to G (Green); If need to connect dimming wires, please also use the connector to connect "Dim+" (purple) to "Dim +" (purple), "Dim-" (gray) to "Dim-" (gray).

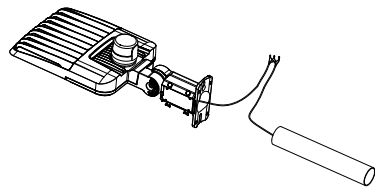

Wiring Diagram

L	—	Fixture
N	—	Fixture
G	—	Fixture
Dim+	—	Fixture
Dim-	—	Fixture

Step 5: Tighten the 4 locking bolts. Loosen the locking bolt on the Slip Fitter with a wrench to adjust the fixture mounting angle, then tighten the locking bolts. Adjustable angle range $\pm 90^\circ$.

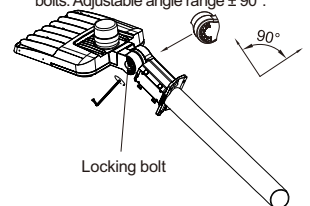

ALH AREA LIGHT Installation Instruction



Please read this manual carefully before using the product

Adjustable Square & Round Pole Mount

Step 1:

Disassemble the Slip Fitter with a wrench. Unscrew the screws, remove the iron bar, open the junction box cover.

Step 2: Run the fixture's AC input wire through the base, then tighten screws to attach the base to the fixture housing.

Bolt torque 3.61ft-lb (4.9N.m)

Step 3: Adjust the hole spacing of the iron bar in advance according to the hole position on the Square or Round Pole. Fix the iron bar to the inside of the light pole with screws (Note: the screw is only screwed into 1/3 of its length), and lead out the input wire.

Step 4: Pass the Pole Mount bracket through the screw and hang it on the screw, tighten this screw, pass the 2nd screw through the holes of Pole Mount bracket, pole and iron bar, then tighten it with a wrench.

Step 5: Loosen the locking bolt on the Slip Fitter with a wrench to adjust the fixture mounting angle, then tighten the locking bolts. Adjustable angle range $\pm 90^\circ$.

Step 6: Pull the fixture's input wire through the wiring hole into the pole and connect the wires inside or pull the wires out from the access panel on the extrusion arm bracket to connect the wires. Close the pole's top cover or extrusion arm bracket panel.

Connect wire inside round pole

Connect wire inside square pole

Wiring Diagram

- L - Live
- N - Neutral
- G - Ground
- Dim+ - Dimmer (+)
- Dim- - Dimmer (-)

Connect wire inside mounting bracket

Wiring Diagram

- L - Live
- N - Neutral
- G - Ground
- Dim+ - Dimmer (+)
- Dim- - Dimmer (-)

TROUBLESHOOTING

1. Check that the line voltage at the fixture is correct. Refer to wiring directions.
2. Is the fixture grounded properly.

Wattage Selectable

1. Unscrew the hatch cover screws
2. Open the driver cover
3. Adjust CCT or Wattage

CCT Options
(40/50)K

Wattage Selectable
(80/100/120/150)W
(170/200/220/240)W
(240/260/280/310)W

Wiring Diagram

