

Direct Indirect Linear

INSTRUCTION MANUAL

Read this instruction carefully before installation. Keep it for further reference. Make electrical and grounded connections in accordance with the national electrical code and any applicable code. Always turn off the power supply before installation. This product must be installed in accordance with the applicable installation code by a qualified electrician who is familiar with the construction and operation of the product and the hazards involved.

Size	Model	Power (Tunable)	Working Current	Input Voltage	CCT (Tunable)	Viewing Angle	Ra	PF	Dimmable	Warranty
4FT	LF-4FT-50W-L-H	40/45/50W	0.5A	AC100-277V	3500K 4000K 5000K 6500K	120°	>80	>0.9	0-10V	5 Years

WARNING:

- ⚠ Risk of electric shock. Fixture installation requires knowledge of luminaires electrical systems. If not qualified, DO NOT attempt installation. Contact a qualified electrician.
- ⚠ Risk of fire or electric shock. Suitable for wet locations. Always turn off the power supply before installation. Risk of fire or electric shock. Suitable for non-insulated surface and frame. DO NOT cover fixture with insulation liner or similar material.
- ⚠ DO NOT install fixture on unstable, loose or easily breakable surface. DO NOT exert force on the surface of the fixture.

Installation

Pendant Mounting, Drywall Ceiling (Offgrid)

1. Preparation

Take out the fixture and accessories package from the box.

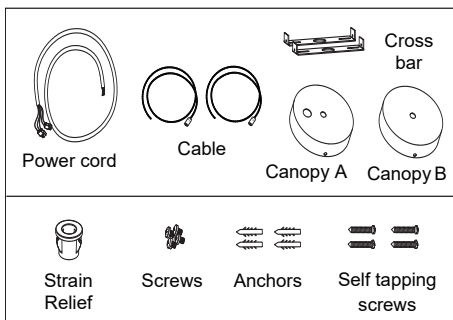

2. Fix cable to canopies

Release locknut, pass the cable through the canopy A and tighten the nut to fix the cable. Repeat to fix cable to canopy B.

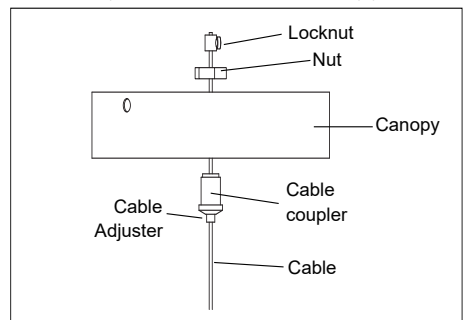

3. Install canopy B and hang the fixture right end

Install the canopy B after positioning the mounting holes with positioning plate. Hang the right end of fixture with cable and adjust to desired height. Make sure that the fixture is securely hung.

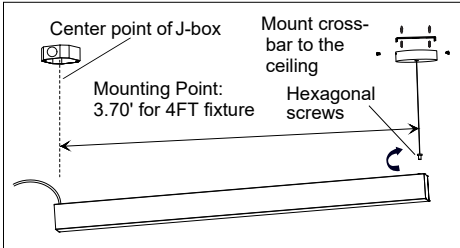

4. Install canopy A

Pass power cord through the canopy A and connect it to main power wires. Mount the cross-bar onto J-box and fix canopy A to the cross bar to cover the J-box.

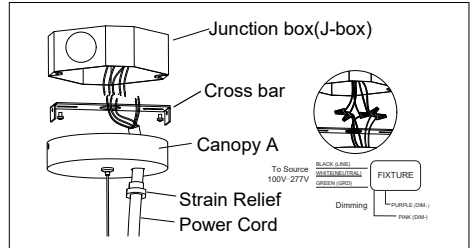

5. Hang the fixture left end

Make sure that the fixture is securely hung. The installation is completed.

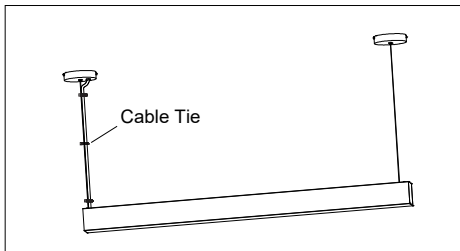

The Installation must be carried out by a qualified electrician.