

NEW CONSTRUCTION CANS 6 INCH

Install Guide and Manual

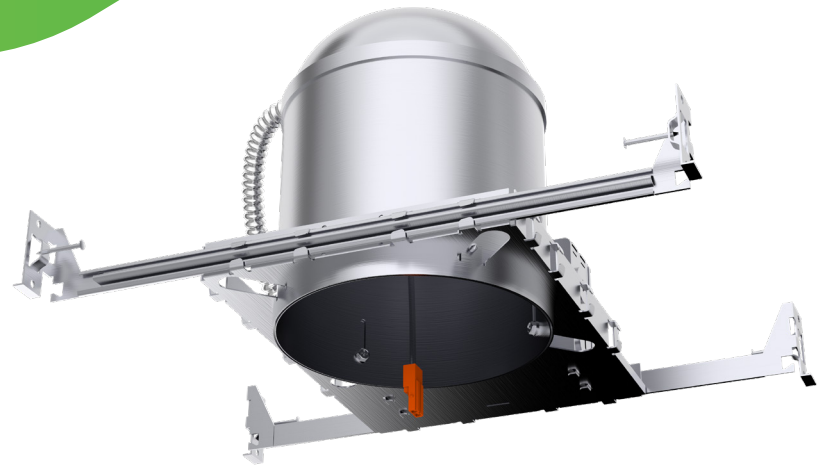

EASY INSTALLATION

Required Tools: Ladder, Hammer, Wire Clippers/Strippers, Pliers, Flathead Screwdriver, Pencil, Compass, Tape Measure, Drywall Saw.

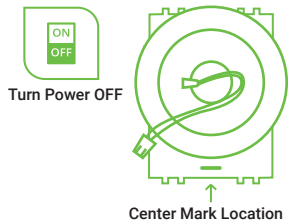

1. Turn off the circuit breaker.
2. Determine placement of can between joists or drop ceiling grid. Consider accessibility to electrical supply.
 - Refer to the center mark on steel frame (see image). Mark center line on joist or grid with pencil.
 - If aligning multiple lights in a row, consider use of an architectural element as a reference point.

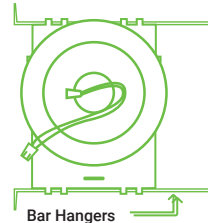

3. Bar hangers come preinserted on the steel frame.
 - Convenient slots on all sides of fixture allow you to reposition bar hangers to suit your needs.

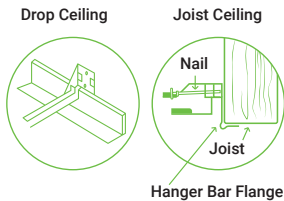

4. Secure bar hangers to joist or grid.
 - **Joist Ceiling** - Extend bar hangers to fit between joists. Hanger bar flange should be level with bottom of joist (see image). Position fixture temporarily by hammering preinstalled nails into joists.
 - **Suspended/Drop Ceilings** - Extend bar hangers 1" past T-bars, then rest fixture on T-bars. Secure fixture to T-bars with wire.

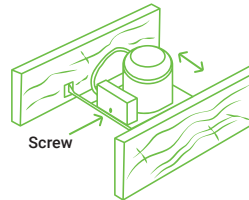

5. Slide housing along hangers to reposition can. Align housing center mark with your pencil mark.
 - Secure housing on hangers by tightening indicated screw
 - If using joists, finalize placement by driving nails in fully.

WARNING

To reduce the risk of fire, electric shock or injury to people:

- This product should be installed in accordance with the applicable installation code by a person familiar with the construction and operation of the product and the hazards involved.
- Abide by related regional and local laws or regulations.
- Proper grounding is required to ensure safety.
- Check for damage during shipping prior to install. If the product is damaged, do not use it.
- Turn off the switch and circuit breaker before installing this LED light fixture.
- To ensure efficient light, regularly clean the light panel. Do not clean with harsh solvents.
- Use safety precautions. Safety eyeglasses and gloves are recommended.
- Please review instructions carefully before proceeding.

IMPORTANT: Fixtures are classified for insulated ceilings (type IC and type-T) and for suspended ceiling (type-S).



EASY INSTALLATION (Continued)

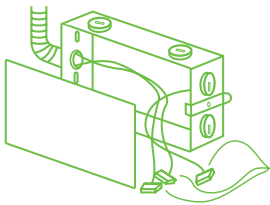

6. Open the junction box by releasing the clamp. Remove a knockout. Feed supply wires through knockout.
 • Consider addition of a tension reliever (not included) to secure wires to j-box or adding wire staples (not included) for cable management outside the j-box.

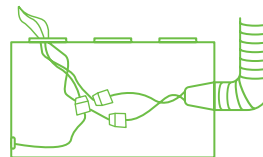

7. Strip insulation and connect supply wires to can wires with included push in connectors.

- Live to Live (black)
- Neutral to Neutral (white)
- Ground to Ground (yellow/green)

8. Tuck wires into j-box. To replace the cover, slide tab on j-box lid into the slot then push to clamp opposite side.



9. Use a compass and your can's center mark to determine hole placement. Cut a 6.3" diameter hole in the ceiling with a drywall saw.

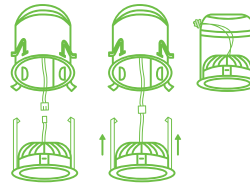

RETROFIT INSTALLATION

10. Once ceiling is installed:

- Attach retrofit to housing with the TP24 cconnector
- Line up trim ring with the can opening
- Hook downlight springs into the housing ears or clip holder slots
- Push downlight up into the housing until it is secured

11. Turn on circuit breaker, and test the light.

SPECIFICATIONS

Voltage	120/277V
Max. Wattage Accepted	24W
Retrofit Size Accepted	6" Diameter
Hanger Adjustment Range	13-5/8" to 25"
Operating Temperature	Max 194°F
Suitable for Locations Ingress	Wet & Damp
Wires	Copper & Plastic Tube

Ideal Connector # 30-682M (male)	Plastic & Copper
Flexible Conduit	Plated Steel
Junction Box/Hanger Bar/Plaster Frame	Galvanized Steel
Housing	Aluminum
Weight	1lb 13oz
Warranty	10 years