

LED EXIT SIGN

Install Guide and Manual

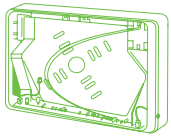

COMPONENTS



X1
Exit Sign Housing



X1
Front + Back Panel



X1
Canopy Mount

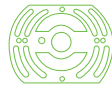

X1
Trim Plate



X2
Support Connectors



X2
Wire Nuts



X2
Screws

TWO MOUNT OPTIONS



CEILING MOUNT



END/WALL MOUNT

IMPORTANT

- Prior to exit sign installation, install junction box in ceiling or wall.
- When re-lamping, use only lamps specified in the exit sign. Using other lamp types may result in transformer damage or unsafe conditions.
- The battery in this unit may not be fully charged upon unboxing. After electricity is hooked up to the unit, let the battery charge for at least 24 hours. It is then ready for normal operation.
- Unused wires must be capped with a wire nut.

EASY INSTALLATION



Turn Power OFF

1. Turn off power.
2. Open housing of exit sign using flathead screwdriver in slots on top. Alternate sides to unsnap entire faceplate.
 - Pull off faceplate and set aside.
3. Remove mounting components (wrapped in plastic for shipping) from the housing. Set aside.

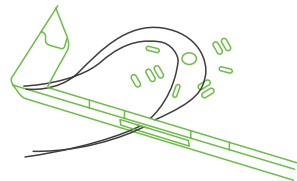

4. Pop out top (ceiling mount) or side (wall mount) knockout, then feed lead wires through hole.
 - Secure wires with wire guide.
- Continued...

Required Tools: Drill, Ladder, Pliers, Screwdriver

WARNING

- To reduce the risk of fire, electric shock or injury to people:
- This product should be installed in accordance with the applicable installation code by a person familiar with the construction and operation of the product and the hazards involved.
 - Abide by related regional and local laws or regulations.
 - Proper grounding is required to ensure safety.
 - Do not use outdoors or mount near gas or electric heaters.
 - Equipment should be mounted in locations and at heights where it will not be subject to tampering by unauthorized personnel.
 - Check for damage during shipping prior to install. If the product is damaged, do not use it.
 - Turn off the switch and circuit breaker before installing this LED light fixture.
 - To ensure efficient light, regularly clean the light panel. Do not clean with harsh solvents.
 - Use safety precautions. Safety eyeglasses and gloves are recommended.

SPECIFICATIONS

Voltage	120-277V
Input Power	1.6W
Suitable for Locations Ingress	Damp
Fire resistant	Yes
Weight	1.65lbs
Warranty	3 years

LED EXIT SIGN

Install Guide and Manual

EASY INSTALLATION (Continued)

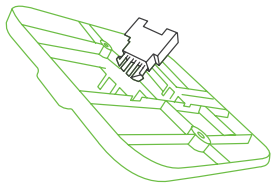

5. Remove canopy and mounting hardware from plastic packaging. Snap 2 support connector in provided slots. These will connect canopy mount plate to housing.

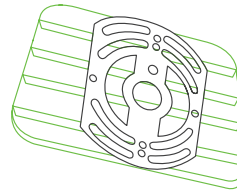

6. Align trim plate to screw holes on back of the canopy mount plate. Turn over.
7. Secure trim plate with 2 provided screws.

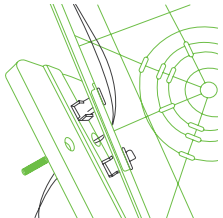

8. Feed lead wires (from face to back) through canopy mount plate and trim plate.
9. Snap canopy mount plate onto exit sign housing.

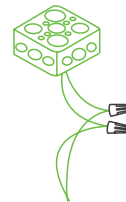

10. Connect exit sign lead wires to AC input leads in junction box (not included).
 • Cap off unused wires with wire nuts
 • Feed excess wire into your J-box
11. Secure canopy mount with exit sign to J-Box using included screws (already holding trim plate in place).

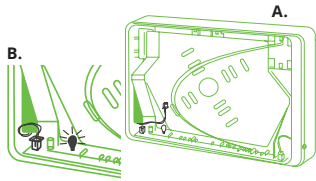

12. Connect battery to the PCB board by plugging wire into socket.

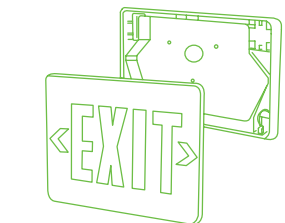

13. Reattach faceplate. Ensure all four corners have snapped together properly.
14. Knock out direction arrow(s), as appropriate for your light fixture location.
15. Turn on power. Battery may need 24 hours to charge before light fixture is used for emergency purposes.

WIRING DIAGRAM

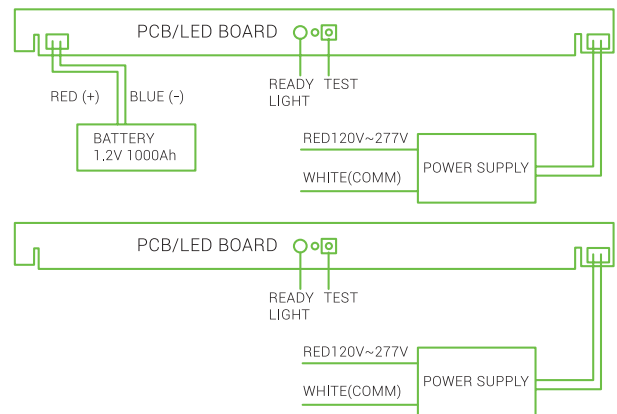

WARNING

- To reduce the risk of fire, electric shock or injury to people:
- This product should be installed in accordance with the applicable installation code by a person familiar with the construction and operation of the product and the hazards involved.
 - Abide by related regional and local laws or regulations.
 - Proper grounding is required to ensure safety.
 - Do not use outdoors or mount near gas or electric heaters.
 - Equipment should be mounted in locations and at heights where it will not be subject to tampering by unauthorized personnel.
 - Check for damage during shipping prior to install. If the product is damaged, do not use it.
 - Turn off the switch and circuit breaker before installing this LED light fixture.
 - To ensure efficient light, regularly clean the light panel. Do not clean with harsh solvents.
 - Use safety precautions. Safety eyeglasses and gloves are recommended.

SPECIFICATIONS

Voltage	120-277V
Input Power	1.6W
Suitable for Locations Ingress	Damp
Fire resistant	Yes
Weight	1.65lbs