

# Sunco

Lighting made better.

User Manual

## 1ft. LED Grow Light

SKU: SH\_GL1-WH-FS



support@sunco.com  
(844) 334-9938



AMERICAN  
COMPANY

# Whats in the Box?

## Grow Light

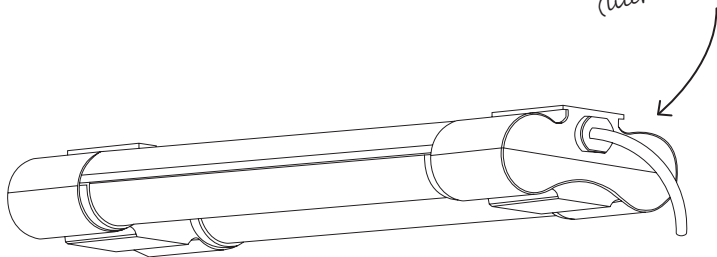

## Safety Information

### To reduce the risk of fire, electric shock, or physical injury:

- Turn off power before changing fixture.
- Suitable for use in damp environments at temperatures ranging from 4°F to 113°F. Not for use where directly exposed to water.
- Not intended for use with emergency fixtures.
- Not compatible with photo controls.
- Not compatible with occupancy sensors.
- Not compatible with dimmers.
- Not compatible with timing devices.
- All electrical connections must be in accordance with local and National Electric Code (N.E.C.) standards.
- Please review installation manual carefully before proceeding. Consult a qualified electrician if you are unfamiliar with proper electrical wiring connections.



### WARNING:

Cancer & Reproductive Harm- [www.P65Warnings.ca.gov](http://www.P65Warnings.ca.gov)

This device complies with Part 15 of the FCC rules. Operation is subject to the following two conditions:

1.) This device may not cause harmful interference.

2.) This device must accept any interference that may cause undesired operation. Please review all instructions carefully prior to installation.

# Installation Guide



## STEP 1

- Turn off circuit breaker before installation.
- Surface must support fixture weight.

Plaster board: Requires 3/8" thickness. Use #8 eye hook screws with anchors or expansion bolts (not included).



## STEP 2

- Drill pilot holes.
- Insert two plastic anchors, then screw each eye hook into an anchor.

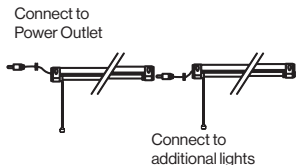

## STEP 3

- Depending on your lighting plan, space any additional anchors accordingly.
- Link up to 4 shop lights together

## Installation Guide (Cont.)

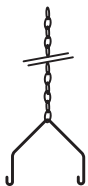

### STEP 4

- Install a "V" hook into one end of the chain link provided. Loop one S Hook onto the other end of the chain. Repeat with second chain.
- Use pliers to crimp ends and secure as needed.

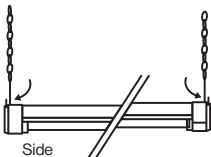

### STEP 5

- Insert the "V" hook ends into the slots in the light fixture end cap. Repeat steps on the opposite side.
- Hang the loose ends of the chain onto the Screw Eye hooks in the ceiling.

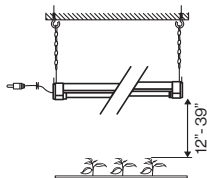

### STEP 6

- Plug the power cord into an electrical outlet. Turn on the circuit breaker and test the light.
- Distance between lamp and plant surface should be between 12 - 39 inches.

# Installation Guide

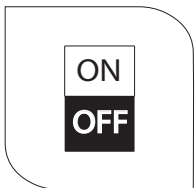

## STEP 1

- Turn off circuit breaker before installation.
- Surface must support fixture weight.

**Plaster board:** Requires 3/8" thickness. Use #8 eye hook screws with anchors or expansion bolts (not included).

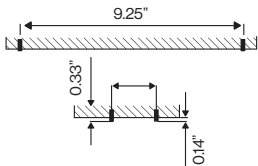

## STEP 2

- Install four plastic anchors 9.25" inches apart. Insert a screw into each anchor.
- Gap between cap nut and ceiling should be 0.33 inches.

## STEP 3

- Depending on your lighting plan, space any additional anchors accordingly.
- Link up to 4 shop lights together

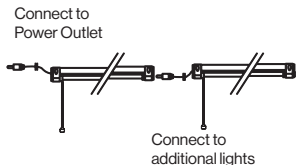

## Installation Guide (Cont.)

### STEP 4

- a. Lift fixture up to screws and slide to one side to secure into place. Fixture should be firmly fixed against screws.

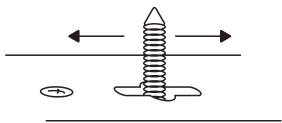

### STEP 5

- a. Distance between lamp and plant surface should be between 12 - 39 inches.

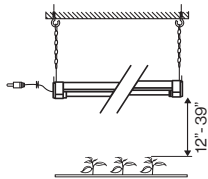

### STEP 6

- a. Plug the power cord into an electrical outlet.
- b. Turn on the circuit breaker and test the light.



# Product Details

## Dimensions

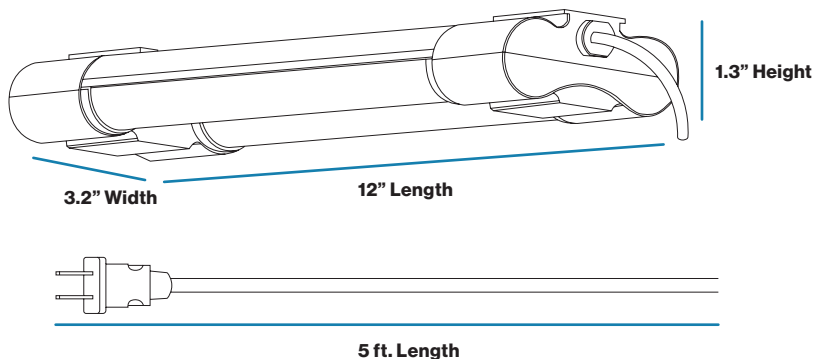

## Specifications

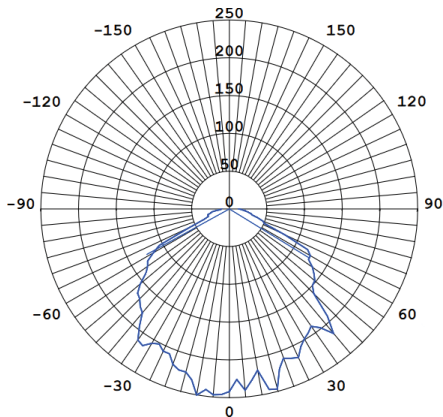

<b>Voltage</b>	120V	<b>Average Lifetime</b>	50000 hrs
<b>Wattage</b>	20W	<b>Lumens</b>	1400LM
<b>Power Factor</b>	>0.7	<b>Moisture Rating</b>	Damp
<b>Beam Angle</b>	120°	<b>CRI</b>	>89
<b>PPF</b>	13.75umol/s	<b>Usage</b>	Indoor
<b>PAR</b>	3106.32lmW	<b>Frequency</b>	60Hz
<b>Dimmable</b>	No	<b>Warranty</b>	3 Years

# Light Distribution Angle



←  
*Not a lighting nerd?  
No worries, you can skip this page*

AVERAGE BEAM ANGLE (50%): 119.7 DEG

	C0/180	119.7°
	C90/270	119.7°

UNIT:cd Luminous Intensity Distribution 1

Lighting distribution angle refers to the spread of light emitted from a light source. It is an important factor to consider when selecting a fixture or bulb, as it affects the way it will illuminate an area. There are two main types of lighting distribution angles: A symmetric lighting distribution emits light evenly in all directions, creating a cone-shaped pattern that provides a pool of light. This type of lighting is ideal for general lighting and illuminating large areas. Common applications for symmetric lighting include general area illumination, security lighting, and perimeter lighting. Symmetric lighting is also used to a

certain degree in up-lighting. An asymmetric lighting distribution angle, also known as beam angle, creates a pattern that focuses light in a specific direction. This type of lighting is ideal for task lighting as it reduces glare and light spill in other areas. Common applications include task lighting in spaces such as landscape settings, retail stores, museums, and much more. It is important to note that the lighting distribution angle can also be affected by other factors such as the reflector design of the light source, the type of lens used, and the distance between the light source and the surface being illuminated.



## Warranty Policy

This product is covered by our industry leading 3 year warranty.

It gets even better - scan the QR code for 2 extra years of protection!



*Scan me for two extra years!*

## 30 Day Return Policy

At Sunco, we value our customers and stand by the quality and performance of our products.

If you are not completely satisfied with your purchase, we accept returns within 30 days of your purchase date.

## Customer Service

Our Los Angeles team of lighting experts is here to assist you with all your needs! Contact us at:

Email: [support@sunco.com](mailto:support@sunco.com)

Call or Text: (844) 334-9938

# Sunco

Lighting made better.

[support@sunco.com](mailto:support@sunco.com)  
(844) 334-9938

REV1.0



AMERICAN  
COMPANY