

# Sunco

Lighting made better.

User Manual

## LED Shop Light

SKU: SH\_F



support@sunco.com  
(844) 334-9938



AMERICAN  
COMPANY

# What's in the Box?

## Shop Light

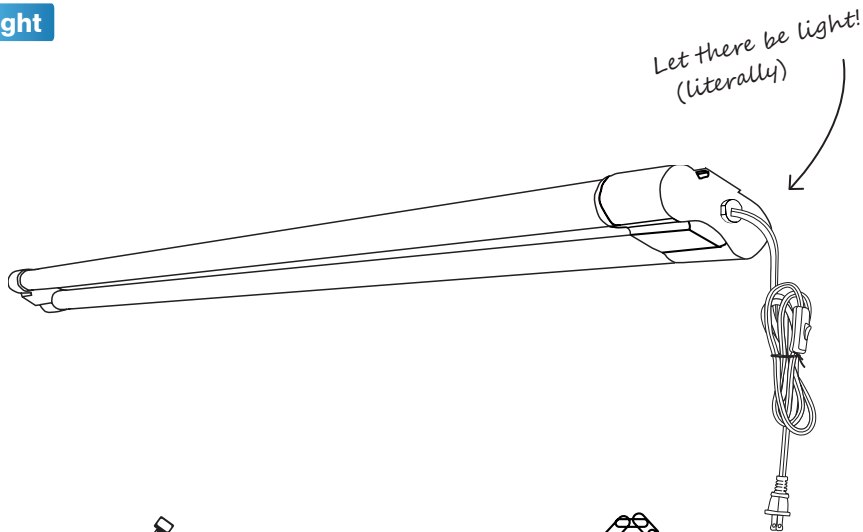

**x1**

Zip Tie

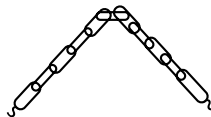

**x2**

Hanging Chains



**x2**

Screw Eye Hook



**x2**

Plastic Anchor



**x2**

Screw

# Before You Start

## Safety Information

### To reduce the risk of fire, electric shock, or physical injury:

- Turn off circuit breaker before installing this fixture.
- Suitable for damp locations at temperature ranging from 4°F to 113°F. Not for use where directly exposed to water.
- Not intended for use with emergency fixtures.
- This product is not compatible with dimmers.
- This product is not compatible with 3rd party sensors.
- This product is not compatible with photo controls.
- This product is not compatible with 3rd party occupancy sensors.
- This product is not compatible with 3rd party timing devices.
- All electrical connections must be in accordance with local National Electric Code (N.E.C.) standards.
- Please review installation manual carefully before proceeding. Consult a qualified electrician if you are unfamiliar with proper electrical wiring connections.

**⚠ WARNING:**  
Cancer & Reproductive Harm - [www.P65Warnings.ca.gov](http://www.P65Warnings.ca.gov)

This device complies with Part 15 of the FCC rules. Operation is subject to the following two conditions:  
1.) This device may not cause harmful interference.

2.) This device must accept any interference that may cause undesired operation. Please review all instructions carefully prior to installation.

## Quickstart Guide

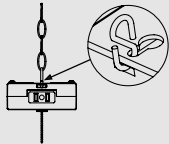

### Step 1

Attach hanging chains to shop light mounting ends.

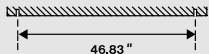

### Step 2

Drill 2 pilot holes into ceiling.

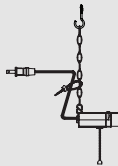

### Step 3

Zip tie fixture cord to chain.

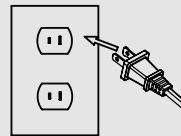

### Step 4

Plug in power cord to electrical outlet.

# Installation Guide (Suspension Install)

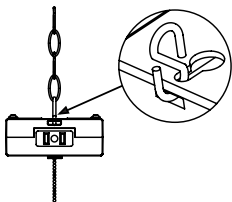

## STEP 1

a. Turn off circuit breaker before installation.

NOTE: Mounting surface must be able to support weight of fixture.

b. Insert hanging chains to the shop light mounting ends.”

(Remove everything else)

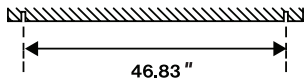

## STEP 2

a. Drill 2 pilot holes into ceiling. Holes should be 46.83” apart.

b. Dry Wall: 7/32” drill bit.

c. Wall Stud: 9/64” drill bit.

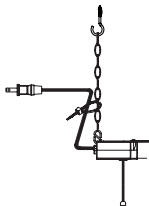

## STEP 3

a. Secure fixture to ceiling by hanging non-crimped portion of S-hooks onto eye hooks. Adjust chain length as needed.

c. Secure fixture power cord to mounting chain using zip tie.

## Installation Guide (Cont.)

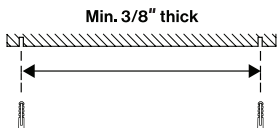

### STEP 4

a. Insert expansion anchors into pilot holes.

**NOTE:** Space fixture to suit your lighting plan and power chord length (60"). 4 units maximum.

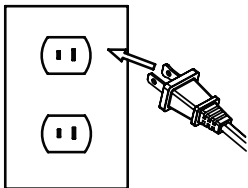

### STEP 5

Plug in power cord to electrical outlet.



### STEP 6

a. Tighten screw eye hooks into expansion anchors.

b. Turn on circuit breaker and test light.

# Installation Guide (Direct Mount Install)

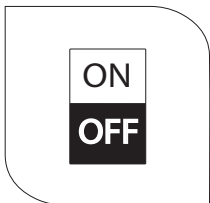

## STEP 1

a. Turn off circuit breaker before installation.

NOTE: Mounting surface must be able to support weight of fixture.

Connect to  
additional  
shop light



Connect to  
Power Outlet

Link up 4 shop  
light together

## STEP 2

NOTE: Space fixture to suit your lighting plan and power chord length (60"). 4 units maximum.

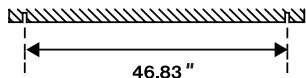

## STEP 3

a. Drill 2 pilot holes into ceiling. Holes should be 46.83" apart.

b. Dry Wall: 7/32" drill bit.

c. Wall Stud: 9/64" drill bit.

## Installation Guide (Cont.)

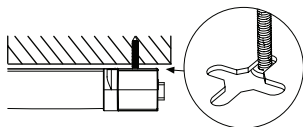

### STEP 4

- a. Align fixture to screws.
- b. When holes are aligned, push fixture up.

Slide to secure.

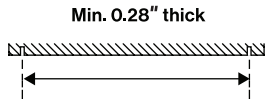

### STEP 5

- a. Insert expansion anchors into pilot holes.
- b. Tighten screws into expansion anchors.
- c. Leave about 0.17" gap between the screw heads & mounting surface.

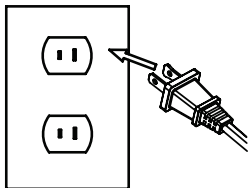

### STEP 6

- a. Plug in power cord to electrical outlet.
- b. Turn on circuit breaker and test light.

# Product Details

## Dimensions

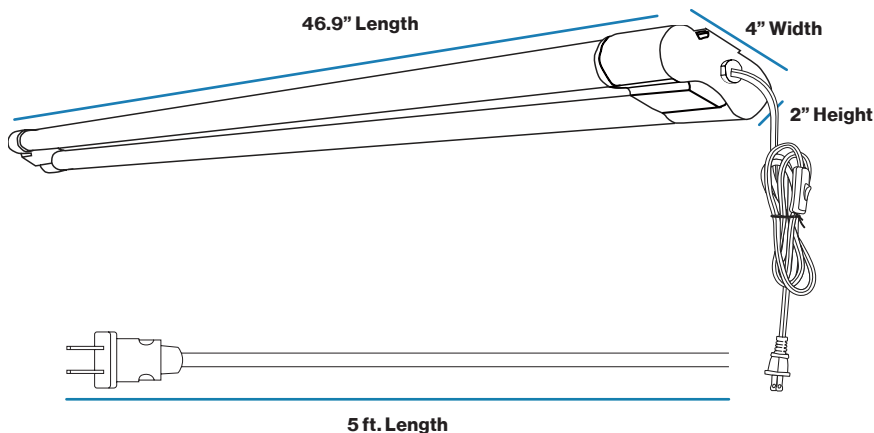

## Specifications

<b>Voltage</b>	120V	<b>Average Lifetime</b>	50,000 hrs
<b>Wattage</b>	40W	<b>Lumens</b>	4500LM
<b>Wattage Equivalency</b>	150W	<b>Moisture Rating</b>	Damp
<b>Beam Angle</b>	120°	<b>CRI</b>	80+
<b>Color</b>	Black/White	<b>Usage</b>	Indoor
<b>Housing Material</b>	Plastic	<b>Frequency</b>	60HZ
<b>Dimmable</b>	No	<b>Warranty</b>	7 Years



# Common Troubleshooting

Feeling in the dark about an issue with your product? No worries! Our troubleshooting section is here to shed some light and provide you with easy-to-follow solutions for any problem.

If you still need some assistance, please feel free to contact us with any questions. Our team of lighting experts are happy to help brighten your day.

## Installation

Light isn't turning on.

Double check if fixture is properly connected and circuit breaker hasn't been tripped.

Light unexpectedly fails.

For further assistance, reach out to customer support.

## Dimming

Light not dimming to lowest setting.

Shop light is not compatible with dimmer switches.

Light not dimming smoothly.

Shop light is not compatible with dimmer switches.

Light not compatible with dimmer switch.

Shop light is not compatible with dimmer switches.

## Flickering

Light is flickering when turning on.

Check plug is fully inserted into socket. Push in completely.

Light flickering with other lights on the same circuit.

Check that the lights on the same circuit are not overloading the circuit.

Light flickering when turned on.

Check plug is fully inserted into socket. Push in completely.

Light flickering when dimmed.

Shop light is not compatible with dimmer switches.

## Linking

How many can be linked?

Link up to four lights on one circuit breaker.

Does Sunco offer longer linking cables?

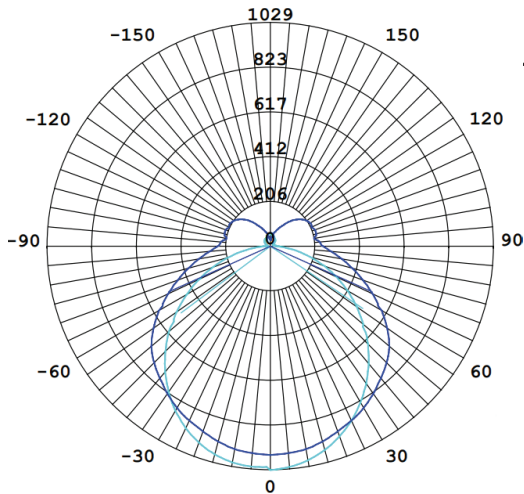

Sunco does not offer longer linking cables

# Light Distribution Angle



←  
*Not a lighting nerd?  
No worries, you can skip this page*

AVERAGE BEAM ANGLE (50%): 120.5 DEG

	C0/180	109.5°
	C90/270	131.6°

UNIT:cd Luminous Intensity Distribution 1

Lighting distribution angle refers to the spread of light emitted from a light source. It is an important factor to consider when selecting a fixture or bulb, as it affects the way it will illuminate an area. There are two main types of lighting distribution angles:

A symmetric lighting distribution emits light evenly in all directions, creating a cone-shaped pattern that provides a pool of light. This type of lighting is ideal for general lighting and illuminating large areas. Common applications for symmetric lighting include general area illumination, security lighting, and perimeter lighting. Symmetric lighting is also used to a certain degree in up-lighting.

An asymmetric lighting distribution angle, also known as beam angle, creates a pattern that focuses light in a specific direction. This type of lighting is ideal for task lighting as it reduces glare and light spill in other areas. Common applications include task lighting in spaces such as landscape settings, retail stores, museums, and much more.

It is important to note that the lighting distribution angle can also be affected by other factors such as the reflector design of the light source, the type of lens used, and the distance between the light source and the surface being illuminated.

## Warranty Policy

This product is covered by our industry leading 7 year warranty.

It gets even better - scan the QR code for 2 extra years of protection!



←  
*Scan me for two extra years!*

## 30 Day Return Policy

At Sunco, we value our customers and stand by the quality and performance of our products.

If you are not completely satisfied with your purchase, we accept returns within 30 days of your purchase date.

## Customer Service

Our Los Angeles team of lighting experts is here to assist you with all your needs! Contact us at:

Email: [support@sunco.com](mailto:support@sunco.com)

Call or Text: (844) 334-9938

# Sunco

Lighting made better.

[support@sunco.com](mailto:support@sunco.com)  
(844) 334-9938

REV1.0



AMERICAN  
COMPANY