

Sunco

Lighting made better.

User Manual

2x4 LED Center Basket Troffer

SKU: PN24_TR_DU-WH-3550K

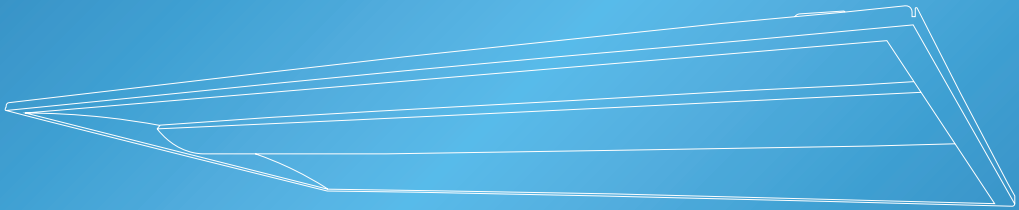

support@sunco.com
(844) 334-9938



AMERICAN
COMPANY

Whats in the Box?

Ceiling Panel

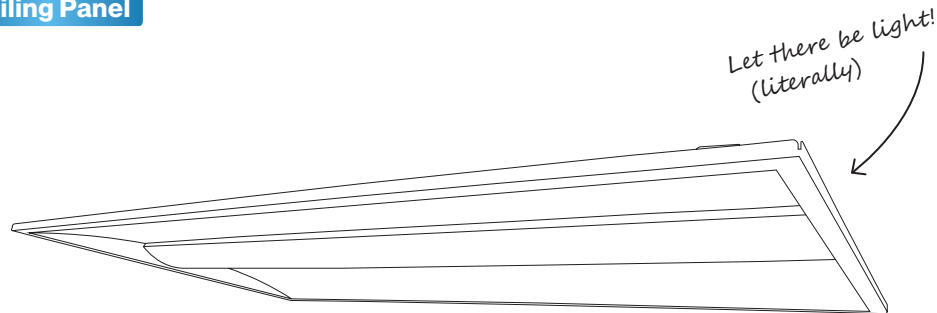

Get Your Gear

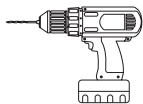

Drill



Hammer



Pliers

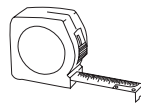

Tape Measure



Pencil



Phillips Screwdriver



Ladder



Leveler

Before You Start

Safety Information

To reduce the risk of fire, electric shock, or physical injury:

- Turn off circuit breaker before installing this fixture.
- Suitable for use in wet environments at temperatures ranging from -4° to 113°.
- Not for use where directly exposed to water.
- Not intended for use with emergency fixtures.
- Not compatible with photo controls.
- Not compatible with occupancy sensors.
- Not compatible with third party sensors.
- Not compatible with all dimmers. For more dimming information, please visit www.sunco.com.
- Not compatible with timing devices.
- All electrical connections must be in accordance with local and National Electric Code (N.E.C.) standards.
- Please review installation manual carefully before proceeding. Consult a qualified electrician if you are unfamiliar with proper electrical wiring connections.

⚠ WARNING:
Cancer & Reproductive Harm - www.P65Warnings.ca.gov

This device complies with Part 15 of the FCC rules. Operation is subject to the following two conditions:
1.) This device may not cause harmful interference.

2.) This device must accept any interference that may cause undesired operation. Please review all instructions carefully prior to installation.

Wiring Diagram

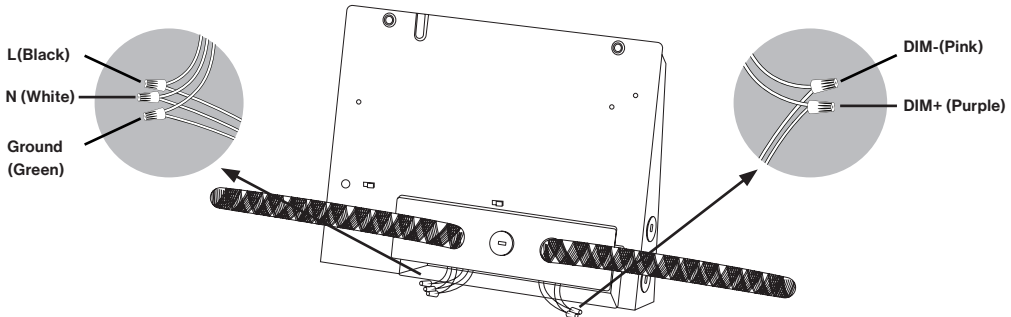

Installation Guide (Recessed Mount)

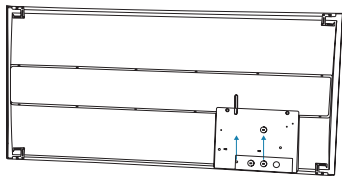

STEP 1

- a. Turn off circuit breaker before installation.
- b. Place Ceiling Panel face down on flat surface. Unscrew 1 driver covers and set aside screws. Pop out knockout (choice of 3).
- c. Optional: if using dimmer, pop out 2nd knockout.

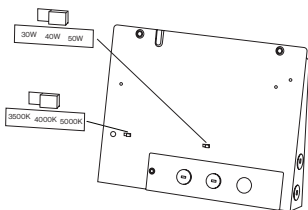

STEP 2

- a. Use switches to choose CCT and brightness settings:

| Brightness | CCT |
|------------|--------|
| -30W | -3500K |
| -40W | -4000K |
| -50W | -5000K |

- b. Connect conduit to each knockout. Feed wires through.

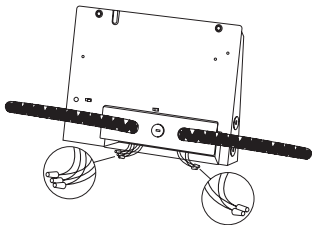

STEP 3

- a. Connect supply and junction wires using wire nuts. Black to Black (Live): White to White (Neutral): Green to Green (Ground).

Optional: To use dimming feature, connect pink and purple wires on Ceiling Panel to compatible dimmer (not included).

Installation Guide (Cont.)

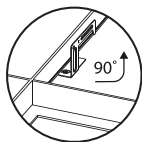

STEP 4

- a. Replace drive covers. Tighten screws.
- b. Bend 4 protective brackets located on back of Ceiling Panel up 90°.

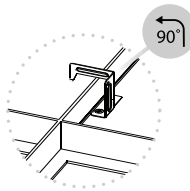

STEP 5

- a. Turn brackets 90°. Hook should face outside edge of Ceiling Panel.

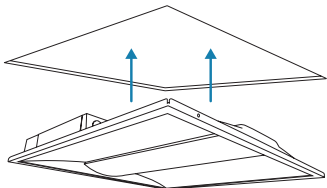

STEP 6

- a. Turn on circuit breaker and test light.

Installation Guide (Suspension Mount)

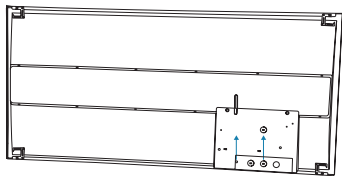

STEP 1

- a. Turn off circuit breaker before installation.
- b. Place Ceiling Panel face down on flat surface. Unscrew 1 driver covers and set aside screws. Pop out knockout (choice of 3).
- c. Optional: If using dimmer, pop out 2nd knockout.

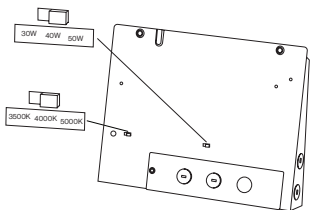

STEP 2

- a. Use switches to choose CCT and brightness settings:

| Brightness | CCT |
|------------|--------|
| -30W | -3500K |
| -40W | -4000K |
| -50W | -5000K |

- b. Connect conduit to each knockout. Feed wires through.

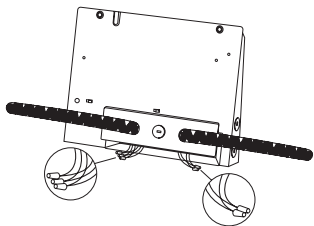

STEP 3

- a. Connect supply and junction wires using wire nuts. Black to Black (Live): White to White (Neutral): Green to Green (Ground).

Installation Guide (Cont.)

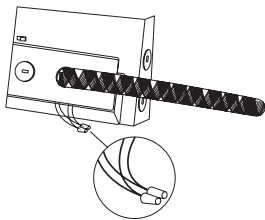

STEP 4

Optional: To use dimming feature, connect pink and purple wires on Ceiling Panel to compatible dimmer (not included).

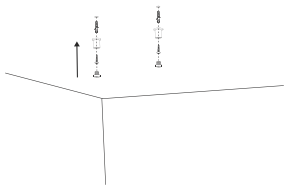

STEP 5

a. Replace drive covers. Tighten screws. Drill 2 holes into ceiling.

b. Place anchors into hole, insert wire rope, and screw.

• Refer to suspension kit's (not included) install manual for complete details.

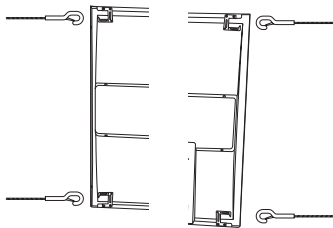

STEP 6

a. Adjust support rope/wire to ensure Ceiling Panel is level.

b. Turn on circuit breaker and test light.

Product Details

Recommended Dimmers

| Brand | Model |
|---------|------------|
| LUTRON | DVSTV |
| LUTRON | NTSTV-DV |
| LUTRON | DVTV |
| LEVITON | AWSMT-7DW |
| LEVITON | DD710-BDZ |
| LEVITON | DS710-10Z |
| LEGRAND | WS4FBL3PTC |
| LEGRAND | RH4FBL3PTC |

Scan for the full compatible dimmer list!



Specifications

| | | | |
|-------------------------|-------------------|-------------------------|--------------|
| Voltage | 120V-277V | Average Lifetime | 50,000 hrs |
| Wattage | 30W/40W/50W | Lumens | Up to 6787LM |
| Power Factor | >0.9 | Temperature | -4° to 113° |
| Beam Angle | 120° | Frequency | 50/60HZ |
| CCT | 3500K/4000K/5000K | Efficacy | 125lm/w |
| Housing Material | Steel | Amps | 0.458A |
| Dimmable | 0-10V | Warranty | 7 Years |

Common Troubleshooting

Feeling in the dark about an issue with your product? No worries! Our troubleshooting section is here to shed some light and provide you with easy-to-follow solutions for any problem.

If you still need some assistance, please feel free to contact us with any questions. Our team of lighting experts are happy to help brighten your day.

Installation

Light isn't turning on.

Double check if fixture is properly connected and circuit breaker hasn't been tripped.

Light unexpectedly fails.

For further assistance, reach out to customer support.

Dimming

Light not dimming to lowest setting.

Ensure minimum dimmer load requirement is met.

Light not dimming smoothly.

Verify dimmer compatibility with fixture.

Light not compatible with dimmer switch.

Check light-dimmer compatibility. Consider purchasing compatible switch if necessary.

Flickering

Light is flickering when turning on.

Check that fixture wiring connections are secure.

Light flickering with other lights on the same circuit.

Check that the lights on the same circuit are not overloading the circuit.

Light flickering when turned on.

Verify fixture compatibility and that it is grounded.

Light flickering when dimmed.

Verify dimmer switch compatibility.

Buzzing

Fixture buzzing with power outages.

Verify light is connected to surge protector securely.

Fixture buzzing with appliances or electronic devices.

Look for nearby interferences that can cause buzzing. Such as televisions, radios, computers, etc.

Fixture buzzing when dimmed.

Verify dimmer switch compatibility.

Light Distribution Angle

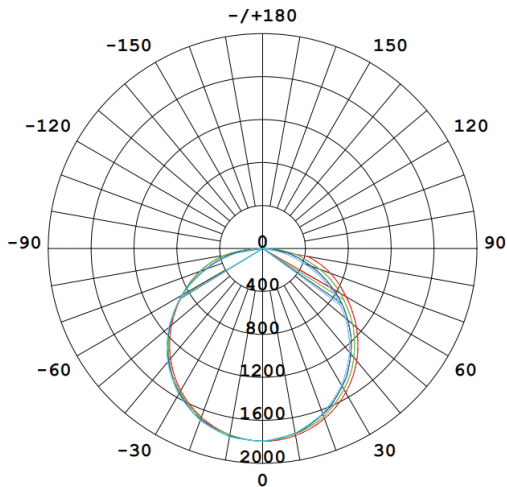

*Not a lighting nerd?
No worries, you can skip this page*

AVERAGE BEAM ANGLE (50%): 115.6 DEG

| | | |
|--------------------------------------|---------|--------|
| — | C0/180 | 118.8° |
| — | C30/210 | 116.9° |
| — | C60/240 | 114.0° |
| — | C90/270 | 112.8° |

UNIT:cd Luminous Intensity Distribution 1

Lighting distribution angle refers to the spread of light emitted from a light source. It is an important factor to consider when selecting a fixture or bulb, as it affects the way it will illuminate an area. There are two main types of lighting distribution angles:

A symmetric lighting distribution emits light evenly in all directions, creating a cone-shaped pattern that provides a pool of light. This type of lighting is ideal for general lighting and illuminating large areas. Common applications for symmetric lighting include general area illumination, security lighting, and perimeter lighting. Symmetric lighting is also used to a certain degree in up-lighting.

An asymmetric lighting distribution angle, also known as beam angle, creates a pattern that focuses light in a specific direction. This type of lighting is ideal for task lighting as it reduces glare and light spill in other areas. Common applications include task lighting in spaces such as landscape settings, retail stores, museums, and much more.

It is important to note that the lighting distribution angle can also be affected by other factors such as the reflector design of the light source, the type of lens used, and the distance between the light source and the surface being illuminated.

Warranty Policy

This product is covered by our industry leading 7 year warranty.

It gets even better - scan the QR code for 2 extra years of protection!



Scan me for two extra years!

30 Day Return Policy

At Sunco, we value our customers and stand by the quality and performance of our products.

If you are not completely satisfied with your purchase, we accept returns within 30 days of your purchase date.

Customer Service

Our Los Angeles team of lighting experts is here to assist you with all your needs! Contact us at:

Email: support@sunco.com

Call or Text: (844) 334-9938

Sunco

Lighting made better.

support@sunco.com
(844) 334-9938

REV1.0



AMERICAN
COMPANY