

Sunco

Lighting made better.

User Manual

Bloom

Solar Garden Light

SKU: GD_MD3_SR-BK-2740K

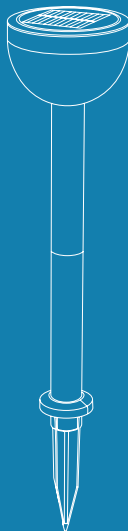

support@sunco.com
(844) 334-9938



AMERICAN
COMPANY

Whats in the Box?

Solar Sidewalk Light

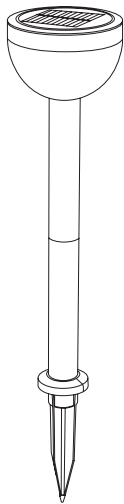

Let there be light!
(literally)

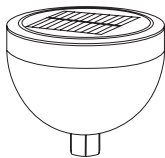

x1

Light

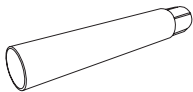

x2

Light Pole

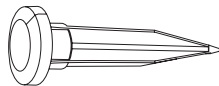

x1

Ground Stake

Before You Start

Safety Information

To reduce the risk of fire, electric shock, or physical injury:

- Suitable for outdoor wet environment ranging from 32°F to 113°F.
- Do not cover the fixture with thermally insulating material.
- Not intended for use with emergency fixtures.
- Not compatible with occupancy sensors.
- Not compatible with dimmers.
- Not compatible with timing devices.
- All electrical connections must be in accordance with local and National Electric Code (N.E.C.) standards.
- Please review installation manual carefully before proceeding. Consult a qualified electrician if you are unfamiliar with proper installation.



WARNING:

Cancer & Reproductive Harm- www.P65Warnings.ca.gov

This device complies with Part 15 of the FCC rules. Operation is subject to the following two conditions:
1.) This device may not cause harmful interference. 2.) This device must accept any interference that may cause undesired operation. Please review all instructions carefully prior to installation.

Quickstart Guide

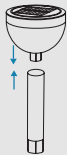

Step 1

Insert light into light pole.

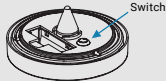

Step 2

Select CCT.



Step 3

Insert light pole into main body.



Step 4

Sunlight access required for location.

Installation Guide

STEP 1

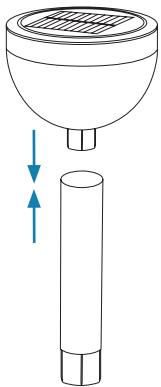

Insert light into light pole.

STEP 2

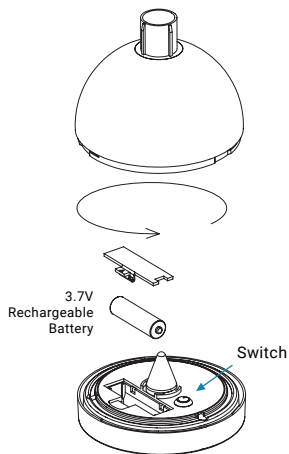

Press the button to select the preferred color temperature. (To replace the rechargeable battery, unscrew the back cover counterclockwise)

Installation Guide (Cont.)

STEP 3

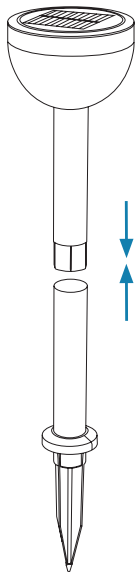

- a. Insert light pole into main body.
- b. Place fully assembled fixture into desired location.

STEP 4

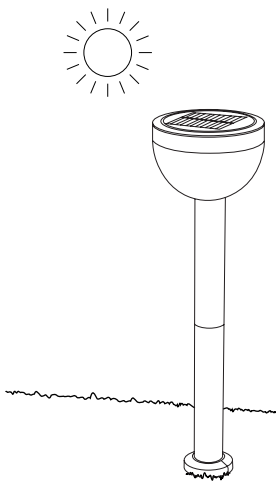

Note: Location should have clear access to sunlight and kept away from other sources of light that could interfere with sensor.

Product Details

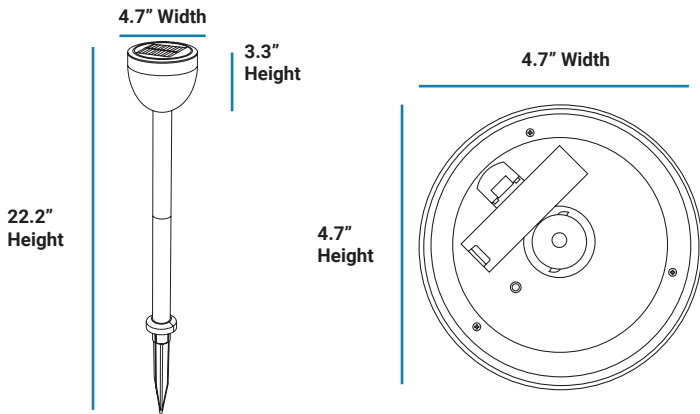

Specifications

Voltage	3.7V	Lifetime	25000 hrs
Wattage	2W	Lumens	120LM
Wattage Equivalency	10W	CRI	70+
Battery	500mAh 3.7V	Frequency	32°F-113°F
CCT	2700K , 4000K	Efficacy	130 lm/W
Housing Material	ABS	Usage	Outdoor
Beam Angle	>100°	Warranty	1 Years
Dimmable	50-100%	Battery Included	Yes
Certification	FCC, RoHS, IP65	Amps	250 mA

Common Troubleshooting

We've got you covered! Our troubleshooting section is here to shed some light and provide you with easy-to-follow solutions for any problem.

If you still need some assistance, feel free to contact us. Our team of lighting experts are happy to help brighten your day.

Installation

Light isn't turning on.

Verify the switch is turned on to the preferred color temperature.

Turned On

Light isn't turning on when switch is on.

Allow the light to sit outdoors for a full day before testing its functionality.

Clean Panel

Light isn't turning on when switch is on.

Verify the solar panels are free of dust, dirt, or debris. Debris on solar panels can reduce their efficiency.

Location

Light isn't turning on in certain location.

Please ensure the solar light is not being obstructed, as it may result in incorrect functioning due to the lack of direct sunlight.

Light Distribution Angle

INTENSITY DISTRIBUTION DIAGRAM
IN C PLANS

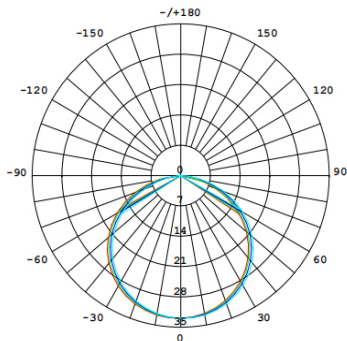

←
*Not a lighting nerd?
No worries, you can skip this page*

AVERAGE BEAM ANGLE (50%): 118.7 DEG

- C0/180 118.8°
- C30/210 118.7°
- C60/240 118.7°
- C90/270 118.6°

UNIT:cd Luminous Intensity Distribution 1

Lighting distribution angle refers to the spread of light emitted from a light source. It is an important factor to consider when selecting a fixture or bulb, as it affects the way it will illuminate an area. There are two main types of lighting distribution angles: A symmetric lighting distribution emits light evenly in all directions, creating a cone-shaped pattern that provides a pool of light. This type of lighting is ideal for general lighting and illuminating large areas. Common applications for symmetric lighting include general area illumination, security lighting, and perimeter lighting. Symmetric lighting is also used to a

certain degree in up-lighting. An asymmetric lighting distribution angle, also known as beam angle, creates a pattern that focuses light in a specific direction. This type of lighting is ideal for task lighting as it reduces glare and light spill in other areas. Common applications include task lighting in spaces such as landscape settings, retail stores, museums, and much more. It is important to note that the lighting distribution angle can also be affected by other factors such as the reflector design of the light source, the type of lens used, and the distance between the light source and the surface being illuminated.

Warranty Policy

This product is covered by our industry leading 1 year warranty. It gets even better - scan the QR code for 2 extra years of protection!



Scan me for two extra years!

30 Day Return Policy

At Sunco we value our customers and stand by the quality and performance of our products.

If you are not completely satisfied with your purchase, we accept returns within 30 days of your purchase date.

Customer Service

Our Los Angeles team of lighting experts is here to assist you with all your needs! Contact us at:

Email: support@sunco.com

Call or Text: (844) 334-9938

Sunco

Lighting made better.

support@sunco.com
(844) 334-9938

REV1.0



AMERICAN
COMPANY