

# Sunco

Lighting made better.

User Manual

## 6" Selectable Slim Downlight

SKU: DL\_SL6-14W; DL\_SL6-BK

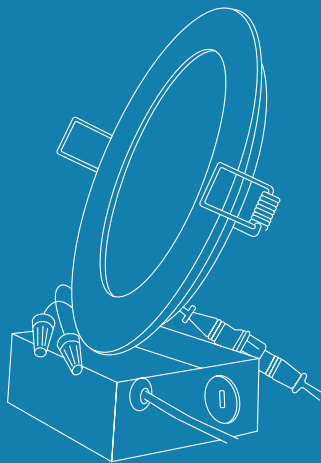

support@sunco.com  
(844) 334-9938



AMERICAN  
COMPANY

# Whats in the Box?

## Slim Downlight

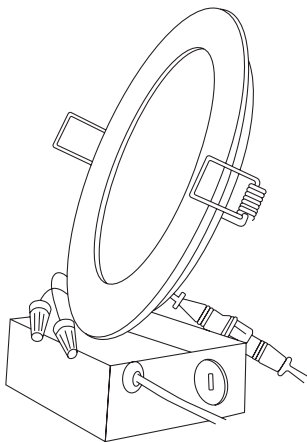

Let there be light!  
(literally)

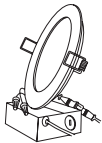

x1

Light Fixture

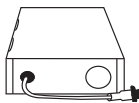

x1

Junction Box



x1

Installation Template



x2

Wire Nuts

## Get Your Gear



Tape

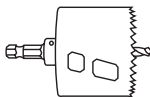

Hole Saw



Ladder



Wire Strippers

# Before You Start

## Safety Information

To reduce the risk of fire, electric shock, or physical injury:

- Turn off circuit breaker before installing this fixture.
- This product should be installed by a person familiar with the construction and operation of the product the hazards involved. Safety eyeglasses and gloves are recommended.
- Abide by related regional and local laws or regulations.
- Proper grounding is required to ensure safety.
- Do not alter, relocate, or remove wiring during installation.
- Do not make or alter any open holes in wiring enclosure or electrical components during installation.
- Check for shipping damage before installing. If the product is damaged, do not use it.
- Keep fixture away from corrosive substances.
- Suitable for damp locations at temperature ranging from 4°F to 113°F. Not for use where directly exposed to water.
- Clean the fixture regularly to ensure proper operation. Do not clean with harsh solvents.
- Use safety precautions and abide by regional and local laws or regulations.
- This product is not compatible with 3rd party sensors.
- This product is not compatible with photo controls.
- This product is not compatible with occupancy sensors.
- This product is not compatible with timing devices.



This device complies with Part 15 of the FCC rules. Operation is subject to the following two conditions:

1.) This device may not cause harmful interference.

2.) This device must accept any interference that may cause undesired operation. Please review all instructions carefully prior to installation.

## Quickstart Guide

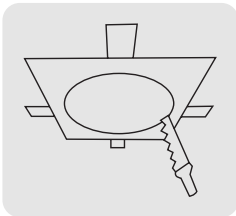

### Step 1

Use template to cut hole.

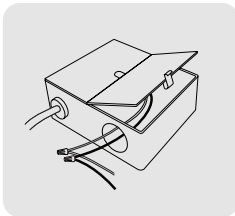

### Step 2

Connect supply & junction wires.

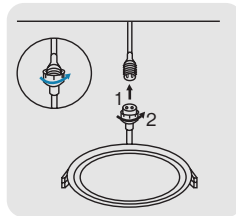

### Step 3

Attach fixture to junction box.

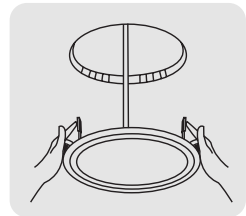

### Step 4

Insert fixture into ceiling.

# Installation Guide

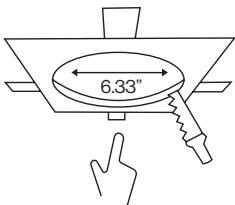

## STEP 1

- a. Turn off circuit breaker before installation.
- b. Cut out 6.33" housing size on Installation Template, then tape onto ceiling in desired location.
- c. Cut ceiling hole using Installation Template as a guide.

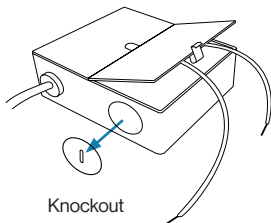

## STEP 2

- a. Open junction box and remove appropriate knockout.

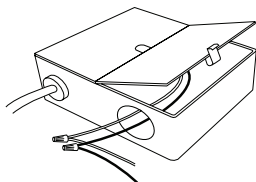

## STEP 3

- a. Connect supply and junction wires using wire nuts:
  - Black to Black (Live)
  - White to White (Neutral)
- b. Tuck connected wires inside junction box and close the cover.

# Installation Guide (Cont.)

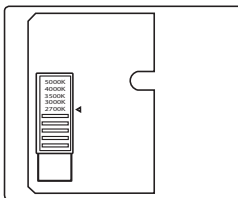

## STEP 4

**Note:** This step applies exclusively to the Selectable Slims.

**Slide the CCT Selection Switch to choose from five color temperatures. Insert junction box through ceiling hole.**

New Construction: Secure to studs, joists, or similar fixed structural units.

Remodel: Do not require to secure to studs, joists, or similar fixed structural units.

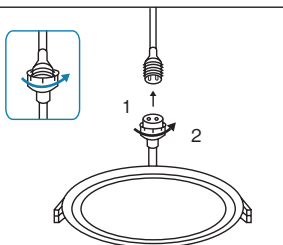

## STEP 5

**a. Attach fixture to junction box using connector as shown on image (1).**

**b. Tighten connector by hand (2).**

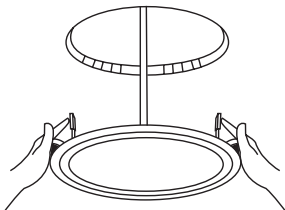

## STEP 6

**a. Push up spring clips and insert fixture into ceiling.**

**b. Turn on circuit breaker and test light.**

# Product Details

## Recommended Dimmers

Brand	Model
LUTRON	P-PKG1WB-WH
LUTRON	MACL-153M-WH
LUTRON	PD-6WCL-WH
LUTRON	AYCL-153P-WH
LUTRON	DVCL-153P-WH
LEVITON	D26HD-2RW
KASA SMART	HS220
KASA SMART	HS220P3

*Scan for the full compatible dimmer list!*



## Specifications

<b>Voltage</b>	120V	<b>Average Lifetime</b>	50,000 hrs
<b>Wattage</b>	14W	<b>Lumens</b>	850LM
<b>Frequency</b>	60HZ	<b>Moisture Rating</b>	Damp
<b>Beam Angle</b>	90°	<b>CRI</b>	90+
<b>Weight</b>	0.6lbs	<b>Color</b>	White, Black
<b>Housing Material</b>	Plastic	<b>IC Rated</b>	Yes
<b>Dimmable</b>	Yes	<b>Warranty</b>	7 Years

# Common Troubleshooting

Feeling in the dark about an issue with your product? No worries! Our troubleshooting section is here to shed some light and provide you with easy-to-follow solutions for any problem.

If you still need some assistance, please feel free to contact us with any questions. Our team of lighting experts are happy to help brighten your day.

## Installation

Light isn't turning on.

Double check if fixture is properly connected and circuit breaker hasn't been tripped.

Light isn't bright enough.

Check proper wattage and for unobstructed fixture.

## Dimming

Light not dimming to lowest setting.

Ensure minimum dimmer load requirement is met.

Light not dimming smoothly.

Verify dimmer compatibility with fixture.

Light not compatible with dimmer switch.

Check light-dimmer compatibility. Consider purchasing compatible switch if necessary.

## Flickering

Light is flickering when turning on.

Check that fixture wiring connections are secure.

Light flickering with other lights on the same circuit.

Check that the lights on the same circuit are not overloading the circuit.

Light flickering when turned on.

Verify fixture compatibility and that it is grounded.

Light flickering when dimmed.

Verify dimmer switch compatibility.

## Buzzing

Fixture buzzing with power outages.

Verify light is connected to surge protector securely.

Fixture buzzing with appliances or electronic devices.

Look for nearby interferences that can cause buzzing. Such as televisions, radios, computers, etc.

Fixture buzzing when dimmed.

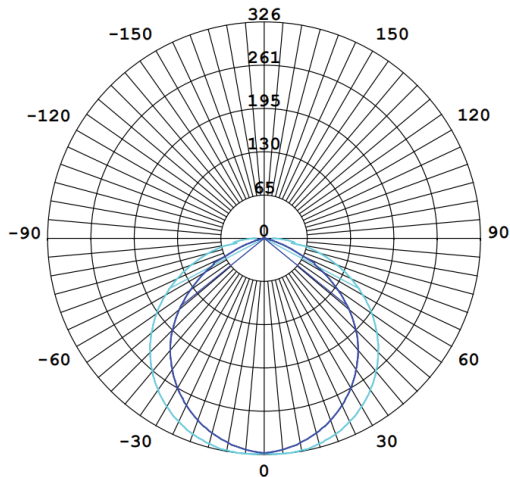

Verify dimmer switch compatibility.

# Light Distribution Angle



*Not a lighting nerd?  
No worries, you can skip this page*

AVERAGE BEAM ANGLE (50%): 113.0 DEG

	CO/180	124.1°
	C90/270	101.9°

UNIT:cd Luminous Intensity Distribution 1

Lighting distribution angle refers to the spread of light emitted from a light source. It is an important factor to consider when selecting a fixture or bulb, as it affects the way it will illuminate an area. There are two main types of lighting distribution angles:

A symmetric lighting distribution emits light evenly in all directions, creating a cone-shaped pattern that provides a pool of light. This type of lighting is ideal for general lighting and illuminating large areas. Common applications for symmetric lighting include general area illumination, security lighting, and perimeter lighting. Symmetric lighting is also used to a certain degree in up-lighting.

An asymmetric lighting distribution angle, also known as beam angle, creates a pattern that focuses light in a specific direction. This type of lighting is ideal for task lighting as it reduces glare and light spill in other areas. Common applications include task lighting in spaces such as landscape settings, retail stores, museums, and much more.

It is important to note that the lighting distribution angle can also be affected by other factors such as the reflector design of the light source, the type of lens used, and the distance between the light source and the surface being illuminated.



## Warranty Policy

This product is covered by our industry leading 7 year warranty.

It gets even better - scan the QR code for 2 extra years of protection!



←  
*Scan me for two extra years!*

## 30 Day Return Policy

At Sunco we value our customers and stand by the quality and performance of our products.

If you are not completely satisfied with your purchase, we accept returns within 30 days of your purchase date.

## Customer Service

Our Los Angeles team of lighting experts is here to assist you with all your needs! Contact us at:

Email:



[support@sunco.com](mailto:support@sunco.com)

Text or Call:



(844) 334-9938

6AM - 6PM PST Monday - Friday

# Sunco

Lighting made better.

support@sunco.com  
(844) 334-9938

REV1.0



AMERICAN  
COMPANY