



## Operation and Installation Manual for

SOLIVIA 3.0 TL  
SOLIVIA 3.8 TL  
SOLIVIA 5.2 TL  
SOLIVIA 6.6 TL  
SOLIVIA 7.6 TL





This manual is subject to change.  
Please check our website at <http://www.delta-americas.com/SolarInverters.aspx>  
for the most up-to-date manual version.

© Copyright – DELTA ELECTRONICS (SHANGHAI) CO.,LTD. - All rights reserved.

This manual accompanies our equipment for use by the end users. The technical instructions and illustrations contained in this manual are to be treated as confidential and no part may be reproduced without the prior written permission of DELTA ELECTRONICS (SHANGHAI) CO.,LTD. Service engineers and end users may not divulge the information contained herein or use this manual for purposes other than those strictly connected with correct use of the equipment. All information and specifications are subject to change without notice.

# Table of Contents

<b>1</b>	<b>General safety instructions</b>	<b>6</b>
1.1	Safety symbols and terminology definitions	7
1.2	Safety Instructions	8
2.1	System	10
2.2	Data evaluation and communication	10
2.3	Technical structure of the solar inverter	11
2.4	Ambient temperature	12
2.5	Solar inverter PV input DC voltage range	12
2.6	Efficiency	13
2.7	Equipment overview	14
2.8	Inverter type and safety labels	16
<b>3</b>	<b>Installation</b>	<b>20</b>
3.1	Visual inspection	22
3.2	Installation location	22
3.3	Mounting the inverter	23
3.4	Required torques for SOLIVIA NA solar inverters	25
4.2	Utility AC voltage	27
4.3	AC circuit breaker requirements	29
4.4	Grounding electrode conductor (GET)	29
4.5	Lightning and surge protection	29
4.6	Multiple inverters	29
4.7	PV string considerations	30
4.8	Inverter connections	30
4.8.1	General information	30
4.8.3	Wiring box conduit plugs	34
4.8.4	PV array string input connections	35
4.8.5	Selecting PV string fuse(s)	38
4.8.6	Inverter AC output wire connections	42
4.8.7	Inverter RS485 communication connections	46
<b>5</b>	<b>Commissioning the PV system</b>	<b>48</b>
5.1	Status LEDs	49
5.2	Display and buttons	49
5.2.1	Components	49
5.2.2	Display layout	49
5.2.3	Buttons	50
5.2.4	General menu structure	50

5.3	Inverter turn-on procedure	50
5.4	Inverter turn-off procedure	51
5.5	Standard initial commissioning	51
5.5.1	Brief overview of the commissioning steps	51
5.5.2	Detailed description of the commissioning steps	51
5.6	Setting values	53
<b>6</b>	<b>Production information</b>	<b>55</b>
6.1	Overview	55
6.2	Current data	56
6.3	Statistics	57
6.4	Resetting statistics	59
<b>7</b>	<b>Settings</b>	<b>60</b>
7.1	Overview	60
7.2	Install settings	60
7.2.1	Date and time	60
7.2.2	Date and time format	61
7.2.3	Contrast	62
7.2.4	Grid change	62
7.2.5	RS485 settings	64
7.3	Grid feed-in settings	65
7.4	Options settings	65
7.4.1	Shading	65
7.4.2	AFCI setting	66
7.4.3	AFCI self test	67
7.4.4	Arc fault clear	68
7.5	Standard menu	69
<b>8</b>	<b>Diagnosis and maintenance</b>	<b>70</b>
8.1	Operating state	70
8.1.1	Types of operating states	70
8.1.2	Factors influencing the operating state	70
8.1.3	Display of the current operating state	71
8.2	Event journal	72
8.2.1	Overview	72
8.2.2	External events menu	72
8.2.3	Change events menu	73
8.3	Diagnosis and correction	73
8.3.1	External events / Insulation and grounding failures	73

8.3.2	Internal failures	76
8.3.3	Other LED and display messages	76
8.4	Displaying grid settings	77
8.5	Internal log	77
8.6	Maintenance	78
<b>9</b>	<b>Repair</b>	<b>78</b>
<b>10</b>	<b>Decommissioning, transport, storage, disposal</b>	<b>79</b>
10.1	Decommissioning	80
10.2	Packaging	80
10.3	Transport	80
10.4	Storage	80
10.5	Dispose	80
<b>11</b>	<b>Certificate and technical data</b>	<b>80</b>
11.1	Certificate	80
11.2	Technical data	81
11.3	FCC compliance information	83
11.4	Canada compliance information	84
<b>12</b>	<b>Warranty</b>	<b>85</b>
<b>13</b>	<b>Appendix</b>	<b>85</b>
13.1	Overview of setting options	85
13.2	Accessory	86
13.3	Overview of menu structure	86
13.3.1	"Go to menu" function	86
13.3.2	Install settings (100)	86
13.3.3	Shading (210)	87
13.3.4	Production information (400)	88
13.3.5	Diagnostic and Alarm (600)	92
13.3.6	Software version/inverter data (700)	92
13.3.7	Standard menu (800)	92
13.4	Connection example	93
<b>14</b>	<b>Glossary</b>	<b>94</b>
<b>15</b>	<b>Warning and errors</b>	<b>97</b>

## Figures

1.	Typical derating curve of SOLIVIA solar inverter TL serials	12
2.	SOLIVIA 3.0 / 3.8 TL PV input DC Voltage Range	12
3.	SOLIVIA 5.2 / 6.6 / 7.6 TL PV input DC Voltage Range	13
4.	SOLIVIA 3.8 / 3.0 TL Efficiency Plot	13
5.	SOLIVIA 7.6 / 6.6 / 5.2 TL Efficiency Plot	14
6.	Exterior view of solar inverter main components	14
7.	Lockable DC Disconnect	15
8.	Location of type label	16
9.	Location of caution labels	17
10.	Dimensions of SOLIVIA 3.0 / 3.8 TL solar inverters	18
11.	Dimensions of SOLIVIA 5.2 / 6.6 / 7.6 TL solar inverters	18
12.	Wiring box connection options	19
13.	Inverter clearances	23
14.	Dimension drawing of mounting plate	24
15.	Installing the plate and inverter on a wood stud wall	24
16.	240V / 120V Split Phase AC Grid	27
17.	208V Delta AC Grid	27
18.	208V / 120V WYE AC Grid	28
19.	240V Delta AC Grid	28
20.	240V / 120V Stinger AC Grid	28
21.	480V Delta AC Grid	28
22.	480V / 277V WYE AC Grid	28
23.	SOLIVIA 3.0 / 3.8 TL Inverter electrical diagram	32
24.	SOLIVIA 5.2 / 6.6 / 7.6 TL Inverter electrical diagram	32
25.	Removing the wiring box cover	33
26.	Locations of wiring box conduit plugs	34
27.	Wiring box conduit plug removal	34
28.	Conduit installation and wiring routing	35
29.	Wiring box - PV input connections	37
30.	Location of string fuse	38
31.	String fuse replacement procedure	41
32.	Conduit installation and AC wiring routing	43
33.	SOLIVIA 3.0 / 3.8 TL - AC voltage loss in different wire sizes and lengths	44
34.	SOLIVIA 5.2 / 6.6 / 7.6 TL - AC voltage loss in different wire sizes and lengths	44
35.	Wiring box AC assembly - terminal labeling	45
36.	Inverter RS485 system diagram	47
37.	RS485 Termination Jumper	47
38.	RS485 (EIA485) connector pin-out	48

# IMPORTANT SAFETY INSTRUCTIONS

## SAVE THESE INSTRUCTIONS

### 1 General safety instructions

This manual contains important instructions for Delta models SOLIVIA 3.0 TL, SOLIVIA 3.8 TL, SOLIVIA 5.2 TL, SOLIVIA 6.6 TL, and SOLIVIA 7.6 TL that should be followed during installation and maintenance of the inverter.

Delta models SOLIVIA 3.0 TL, SOLIVIA 3.8 TL, SOLIVIA 5.2 TL, SOLIVIA 6.6 TL, and SOLIVIA 7.6 TL inverters are designed and tested to meet all applicable North American and International safety standards. However, like all electrical and electronic equipment, safety precautions must be observed and followed during installation and operation of the Delta SOLIVIA inverters to reduce the risk of personal injury and to ensure a safe installation.

Installation, commissioning, service, and maintenance of Delta models SOLIVIA 3.0 TL, SOLIVIA 3.8 TL, SOLIVIA 5.2 TL, SOLIVIA 6.6 TL, and SOLIVIA 7.6 TL inverters must only be performed by qualified personnel that are licensed and/or satisfy state and local jurisdiction regulations.

Before starting installation or commissioning of the Delta models SOLIVIA 3.0 TL, SOLIVIA 3.8 TL, SOLIVIA 5.2 TL, SOLIVIA 6.6 TL, and SOLIVIA 7.6 TL, read through the entire manual and note all DANGER! WARNING! CAUTION!, and NOTICE! statements.

All US electrical installations must comply and be in accordance with all the state, local, utility regulations, and National Electrical Code ANSI/NFPA 70.

For installations in Canada, please ensure these are done in accordance with applicable Canadian standards.

Ce guide contient d'importantes instructions concernant les onduleurs solaires Delta SOLIVIA 3.0 TL, SOLIVIA 3.8 TL, SOLIVIA 5.2 TL, SOLIVIA 6.6 TL, et SOLIVIA 7.6 TL qui doivent être observées au cours de l'installation et de l'entretien de l'onduleur.

Les onduleurs solaires Delta SOLIVIA 3.0 TL, SOLIVIA 3.8 TL, SOLIVIA 5.2 TL, SOLIVIA 6.6 TL, et SOLIVIA 7.6 TL sont conçus et testés pour répondre à toutes les normes de sécurité nord-américaines et internationales applicables. Cependant, comme pour tous les équipements électriques et électroniques, des mesures de sécurité doivent être respectées et observées durant l'installation et l'exploitation des onduleurs SOLIVIA de Delta afin de réduire le risque de préjudice corporel et de garantir la sécurité de l'installation.

L'installation, la mise en service, l'entretien et la maintenance des onduleurs solaires Delta SOLIVIA 3.0 TL, SOLIVIA 3.8 TL, SOLIVIA 5.2 TL, SOLIVIA 6.6 TL, et SOLIVIA 7.6 TL doivent être entreprises uniquement par un personnel qualifié autorisé et/ou répondant aux critères des règlements locaux ou nationaux applicables.



Lisez l'intégralité du manuel et prenez note de toutes les déclarations relatives à la sécurité sous les rubriques intitulées DANGER ! AVERTISSEMENT ! PRUDENCE ! et AVIS ! avant de commencer l'installation ou la mise en service des onduleurs solaires SOLIVIA 3.0 TL, SOLIVIA 3.8 TL, SOLIVIA 5.2 TL, SOLIVIA 6.6 TL, et SOLIVIA 7.6 TL.

Toutes les installations électriques nord-américaines doivent être conformes et respecter tous les règlements des services publics, nationaux, locaux ainsi que le National Electrical Code ANSI/NFPA 70.

Pour toute installation au Canada, veuillez vous assurer que les installations sont conformes aux normes canadiennes applicables.

## 1.1 Safety symbols and terminology definitions



DANGER indicates a hazardous situation which, if not avoided, will result in death or serious injury.

DANGER indique une situation dangereuse qui, si elle n'est pas évitée, est susceptible de provoquer un décès ou des blessures graves.



WARNING indicates a hazardous situation which, if not avoided, could result in death or serious injury.

AVERTISSEMENT indique une situation dangereuse qui, si elle n'est pas évitée, est susceptible de provoquer un décès ou des blessures graves.



CAUTION indicates a hazardous situation which, if not avoided, could result in minor or moderate injury.

PRUDENCE indique une situation dangereuse qui, si elle n'est pas évitée, est susceptible de provoquer des blessures légères ou de degré moyen.



NOTICE indicates a situation that can result in property damage if not avoided.

AVIS indique une situation susceptible de provoquer des dommages à la propriété, si elle n'est pas évitée.



INFORMATION provided that when known and used will ensure optimal operation of the system.

La connaissance et l'utilisation des INFORMATIONS fournies garantissent un fonctionnement optimal du système.



**HIGH VOLTAGE WARNING!** Indicates hazardous high voltages are present, which, if not avoided, will result in death or serious injury. Thus, only authorized and trained personnel should install and/or maintain this product.

**AVERTISSEMENT HAUTE TENSION!** indique la présence de hautes tensions présentant un danger susceptibles de provoquer un décès ou des blessures graves si elles ne sont pas évitées. Par conséquent, l'installation et/ou l'entretien de ce produit doivent être entreprises uniquement par un personnel autorisé et formé.



Hot surface

Surface chaude



Equipment grounding conductor (PE)

(PE) Équipement conducteur de terre



Wait for a prescribed amount of time before engaging in the indicated action.

Patientez le délai requis avant d'entreprendre l'action indiquée.

## 1.2 Safety Instructions

The inverter installation must be performed by an authorized electrician in accordance with the local and National Electrical Code ANSI/NFPA 70 and OSHA requirements.

- The inverter section contains no user-serviceable parts. For all service and maintenance, the inverter should be returned to a Delta Authorized Service Center.
- Read all of these instructions, cautions, and warnings for the Delta SOLIVIA inverter and associated PV array documentation.
- Before connecting the Delta SOLIVIA inverter to the AC distribution grid, approval must be received by the appropriate local utility as required by national and state interconnection regulations, and must be connected only by qualified personnel.
- In operation, the inverter wiring and connections can have hazardous high voltages and currents present, thus only authorized and qualified personnel shall install and/or maintain the inverter.
- In some operation instances, the inverter chassis and heatsink surfaces may become hot.
- PV solar arrays produce hazardous voltages and currents when exposed to light which can create an electrical shock hazard. Use dark opaque sheets to cover the PV solar array before wiring or connecting cable terminations.

L'installation et la mise en service doivent être effectuées par un électricien autorisé conformément aux exigences locales et nationales ainsi qu'au National Electrical Code ANSI/NFPA 70 et condition nécessaire OSHA.

- L'onduleur ne comporte aucune pièce pouvant être réparée par l'utilisateur. Afin de réduire les risques de choc électrique, contactez le personnel d'entretien qualifié de l'usine à propos des opérations d'entretien.
- Lisez toutes les instructions, rubriques Prudence et Avertissement de l'onduleur Delta SOLIVIA, ainsi que la documentation sur le panneau photovoltaïque associé.
- Avant de connecter l'onduleur solaire Delta SOLIVIA au réseau de distribution du courant alternatif (CA), une autorisation doit être obtenue de la part des services publics locaux de tutelle, conformément aux règlements concernant l'interconnexion nationale et locale. La connexion ne doit être effectuée que par un personnel qualifié.
- Des courants et des tensions de hautes intensités dangereuses peuvent être présents dans le câblage et les connexions de l'onduleur en marche, par conséquent, l'installation et/ou la maintenance de l'onduleur doivent être entreprises uniquement par un personnel autorisé et qualifié.
- Sous certains régimes de fonctionnement, le châssis de l'onduleur et les surfaces des dissipateurs de chaleur peuvent devenir chaud.
- Les panneaux solaires photovoltaïques produisent tensions et courants dangereux lorsqu'ils sont exposés à la lumière et constituent un danger de choc électrique. Couvrez le panneau solaire photovoltaïque à l'aide de morceaux de tissu opaques et foncés avant tout câblage ou connexion des terminaisons de câble.

## 2 Introduction

With this device you have acquired a solar inverter for connection of photovoltaic systems to the grid. This solar inverter is characterized by an advanced housing design and state-of-the-art high-frequency technology, which enable the highest levels of efficiency.

The solar inverter includes series monitoring units, such as anti-islanding protection, display, RS485 (EIA485) interfaces.

The inverter is usable indoor and outdoor. It fulfills the directives of ANSI/NFPA 70, NEC 690.5, UL 1741, IEEE 1547 and IEEE 1547.1 for parallel operation of power generation plants on low-voltage network of regional electrical utility companies. Additionally, Delta SOLIVIA inverters are evaluated for compliance with HECO Tariff Rule 14H and TOV (transient over-voltage) standard required by Hawaiian Electric Companies. If the HECO grid is selected, the equipment is special purpose utility interactive inverter.

The function of the anti-islanding protection (automatic isolation point for in-plant generation systems) stipulates compliance with the specifications of UL 1741 and IEEE 1547.

In the following technical description, the precise functions are explained to the installer, as well as the user, which are required for the installation, operational start-up and handling of the solar inverter.

## **2.1 System**

The content of renewable energy with respect to overall power consumption worldwide is increasing annually by approximately 25%. The reason for this rise can be primarily attributed to the constantly increasing demand for power, the increasing interest in environmentally friendly technologies, as well as the increasing costs of non-renewable energy.

By the use of renewable energy sources, the earth's atmosphere can be enormously relieved of increases in CO<sub>2</sub> and other harmful gases which result from power generation.

The solar inverter converts direct current from the solar cells into alternating current. This enables you to feed your self-produced solar energy into the public grid.

Thanks to efficient MPP tracking, maximum capacity utilization of the solar energy plant is ensured even in cases of misty and cloudy skies.

The string concept means that PV modules are always connected in series (in a string) and/or that strings with the same voltage are connected in parallel to the solar inverter with the aim of significantly reducing the photovoltaic system's cabling requirements.

The fact that the modules are connected in strings also means that the photovoltaic system can be perfectly matched to the solar inverter's input voltage range.

The inverter is transformerless type without galvanic isolation. Therefore, the inverter may only be operated with ungrounded PV arrays. Furthermore, the PV array must be installed in accordance with the NEC690.35 (Ungrounded Photovoltaic Power Systems) and the locally valid regulations for ungrounded PV arrays. Additionally, the PV array (PV modules and cabling) must have protective insulation and the PV modules used must be suitable for use with this inverter. PV modules with a high capacity to ground may only be used if their coupling capacity does not exceed 1,200 nF with 60Hz grid.

## **2.2 Data evaluation and communication**

The integrated data display, processing and communication of the device enables easy operation of the solar inverter. Monitoring of the operational status and signaling of operational failures are capable of being called up over the device display. The data interfaces enable the downloading of data which can be evaluated with the aid of a PC system and allow continuous recording of operating data.

The best way of accessing this functionality is via a monitoring system connected to your inverter.

The read-out of the data over the integrated interface (RS485) and the display is possible only in solar operation.

### 2.3 Technical structure of the solar inverter

The photovoltaic voltage is adjusted so that the maximum power output of the PV modules is also achieved with different solar irradiation levels and temperatures (MPP-Tracking). These inverters have quite wide MPP range of suit for variety of PV modules by a variety of manufacturers. Measures must be taken to ensure that the maximum no-load voltage of 600 V is never exceeded. Please note that the maximum no-load voltage will occur at the lowest temperatures anticipated. You will find more detailed information about temperature dependency in the data sheet for the PV modules.

The high-quality aluminum casing corresponds to protection degree NEMA 4 / IP65 (water-jet proof and dust-proof) and is protected by an anti-corrosion finish. The heat sink on the SOLIVIA inverters is designed in such a way that operation of the inverter is possible at ambient temperatures from -13°F to +122°F (-25°C to +50°C) at full power and optimal efficiency for either 240 Vac or 208 Vac AC grids.

Metal fins designed into the rear side of the inverter chassis are used to dissipate heat and protect the unit. An internal temperature control protects the interior of the device. In case of high ambient temperatures, the maximum transferable power is limited.

The solar inverter is controlled by microcontrollers which provide interface communication and the values and messages on the front-panel display.

AC grid monitoring is done by an independent dedicated micro controller set up to meet the requirements of UL 1741 / IEEE 1547. This enables a connection of the solar inverter to the in-house grid.

Operator protection requirements are met by electrically isolating the grid from the PV module. The electrical isolation between the grid and the PV module is equivalent to basic insulation. Maximum operator protection is ensured by reinforced isolation between the grid, PV modules and accessible interfaces (display, RS485 interface and fan port). Relevant standards concerning electromagnetic compatibility (EMC) and safety are fulfilled.

The solar inverter is functional in grid-parallel operation exclusively. An automatically anti-islanding function, which was accepted by a certification agency, guarantees secure disconnection in case of circuit isolation or interruptions in power supply and avoid isolated operation.

The DC arc-fault circuit interrupt (AFCI) is integrated into SOLIVIA 3.0 TL, SOLIVIA 3.8 TL, SOLIVIA 5.2 TL, SOLIVIA 6.6 TL, and SOLIVIA 7.6 TL. It complies the requirement as Type 1 device in UL1699B standard, series arc faults can be detected.

## 2.4 Ambient temperature

The solar inverter can be operated in an ambient temperatures from -13 °F to 158 °F (-25°C to +70°C). The following diagram illustrates how the output power of the solar inverter is reduced automatically in accordance with ambient temperature.

The device should be installed in a well-ventilated, cool and dry location.

Due to tolerance of temperature sensor and efficiency difference under different PV voltage, this derating curve may be a little different from actual behaviors of unit.

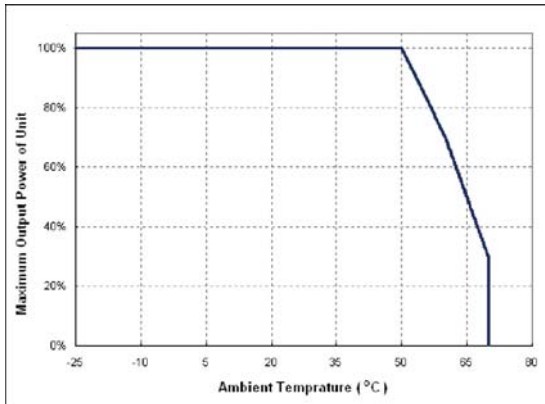


Figure 1: Typical derating curve of SOLIVIA solar inverter TL series

## 2.5 Solar inverter PV input DC voltage range

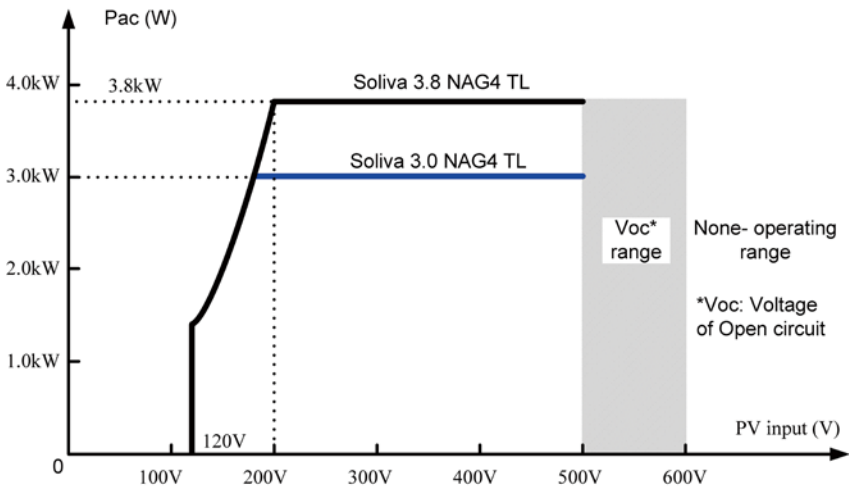


Figure 2: SOLIVIA 3.0 / 3.8 TL PV input DC voltage range

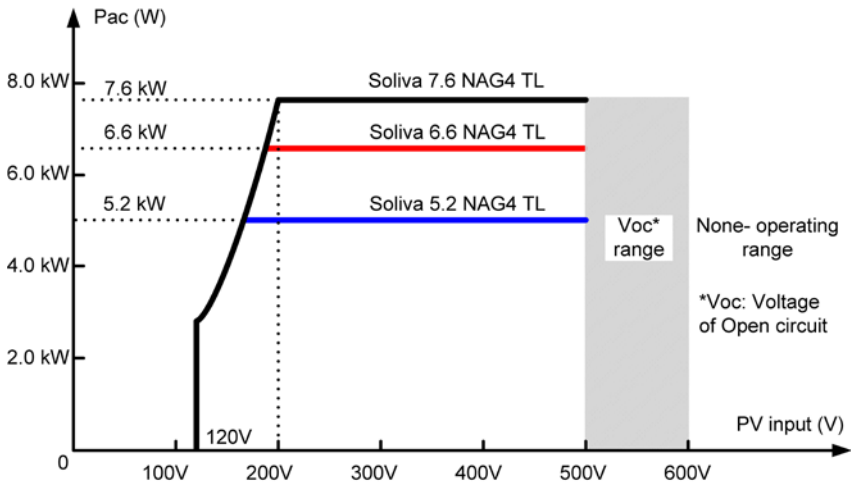


Figure 3: SOLIVIA 5.2 / 6.6 / 7.6 TL PV input DC voltage range

## 2.6 Efficiency

The best efficiency of the solar inverter is obtained at input voltages > 320V for 208V grid, and input voltages > 380V for 240V grid. The curve is obtained at 240V grid.

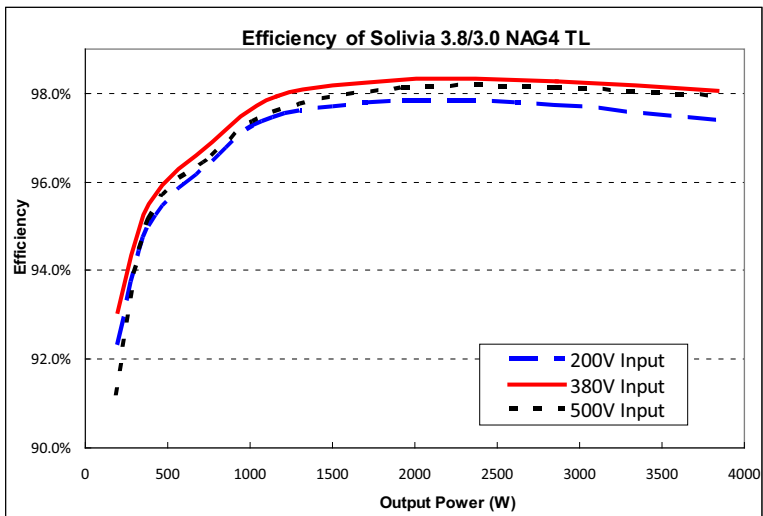


Figure 4: SOLIVIA 3.8 / 3.0 TL efficiency plot

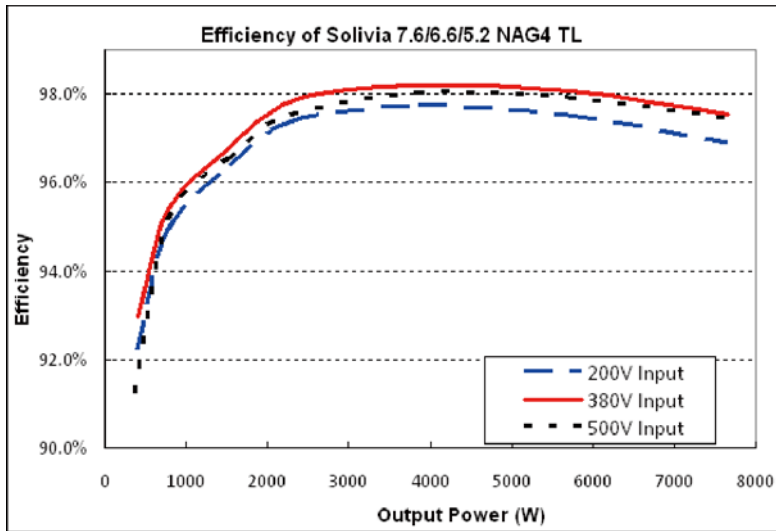
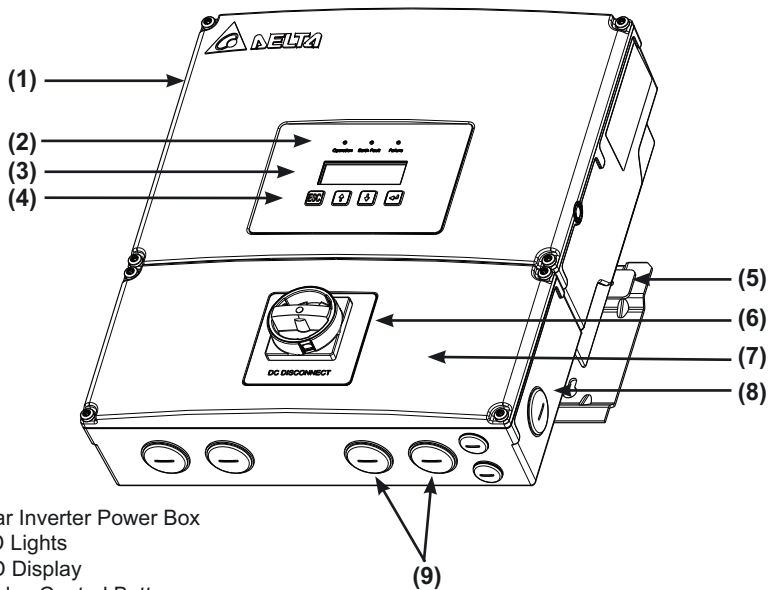


Figure 5: SOLIVIA 7.6 / 6.6 / 5.2 TL efficiency plot

## 2.7 Equipment overview



- (1) Solar Inverter Power Box
- (2) LED Lights
- (3) LCD Display
- (4) Display Control Buttons
- (5) Mounting Plate
- (6) Lockable DC Disconnect
- (7) Wiring Box Cover
- (8) Wiring Box
- (9) Conduit Plugs

Figure 6: Exterior view of solar inverter main components



A further description of the equipment features:

(1) Solar Inverter Power Box - This is the inverter section of the assembly. This section is sealed at the factory and there are no user-serviceable parts inside. All wiring to install the inverter is done in the wiring box.

(2) LED Lights - The three LED lights indicate errors or status as described in section 8.

(3) LCD Display - The 20 character, 4 line LCD display shows important messages regarding the inverter status and performance.

(4) Display Control Buttons - These 4 buttons allow the user to access status and performance information and to change settings via the display.

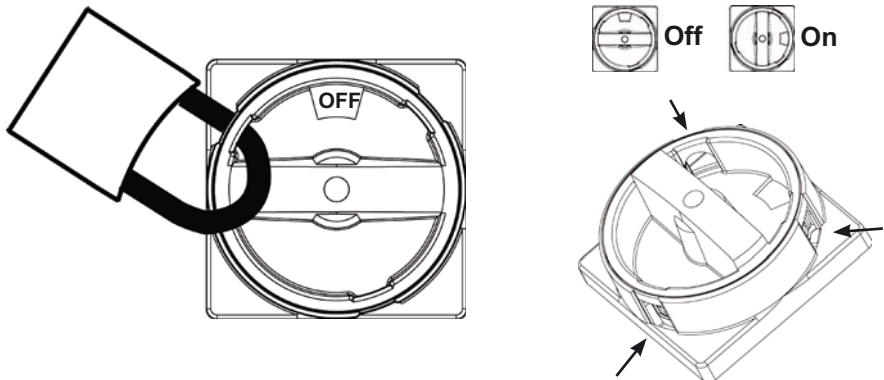
(5) Mounting Plate - The inverter ships with a mounting plate that allows easily assembly of the inverter to a wall.

(6) Lockable DC Disconnect - The DC disconnect is lockable per the UL code and allows for the DC power to be switched off to the inverter. See figure 7 below.

(7) Wiring Box Cover - This is the cover for the wiring compartment. The removal procedure is shown on page 30. Please note the DC disconnect must be in the OFF position before this cover can be removed.

(8) Wiring Box - This is the compartment where all the wiring for the inverter inputs and outputs plus the RS485 communication are done.

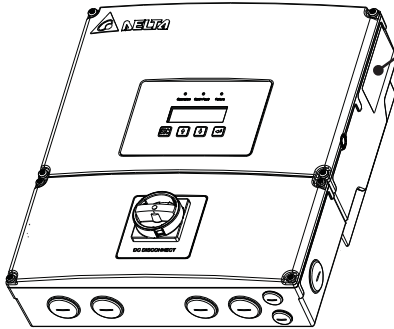
(9) Conduit Plugs - There are 6 - 1" conduit openings and 2 - 1/2" conduit openings. Each conduit opening comes fitted with a conduit plug that should be removed before installing conduit fittings. Conduit fittings need to be water tight with either NEMA 4, 4X, 6, or 6X rated, and insulated type is preferred.



**Figure 7: Lockable DC Disconnect**

DC Disconnect shown with lock in off position. There are three openings on the disconnect where a padlock can be attached as shown above.

## 2.8 Inverter type and safety labels



### SOLiViA 3.8 TL

DC Max. System Voltage:	600V	
DC Operating Voltage Range:	120-550V	
DC Full Power MPPT Range:	200-500V	
DC Max. Input Current:	20A	
AC Nominal Output Voltage:	208V	240V
AC Operating Voltage Range:	183-228V	211-264V
AC Max. Continuous Output Current:	16A	16A
AC Max. Continuous Output Power:	3300W	3800W
AC Nominal Output Frequency:	60Hz	
AC Operating Frequency Range:	59.3 - 60.5Hz	
Output Power Factor:	0.99	

UL 1741		Integrated PV AFCI
CSA107.1	LISTED	Type 1
UL 1699B	photovoltaic utility interactive inverter	E255963

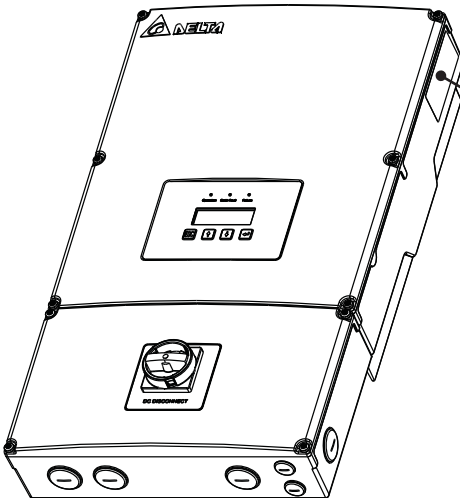
This device complies with Part 15 of FCC Rules: Operation is subject to the following two conditions: (1) this device may not cause harmful interference and (2) this device must accept any interference received, including interference that may cause undesired operation.

Enclosure Type: NEMA 4  
Utility-Interactive, Transformerless Inverter  
Ambient Temp.: -25°C...+70°C, derating >50°C

--	--	--	--	--

SOLiViA.3.8NAG4TL  
GOE46010002A  
Rev.: XX  
Date Code: YYWW  
S/N: LLLMMXXYYWZZZZZ

www.delta-americas.com/solarinverters.aspx  
Made in: China



### SOLiViA 7.6 TL

DC Max. System Voltage:	600V	
DC Operating Voltage Range:	120-550V	
DC Full Power MPPT Range:	200-500V	
DC Max. Input Current:	2x20A	
AC Nominal Output Voltage:	208V	240V
AC Operating Voltage Range:	183-228V	211-264V
AC Max. Continuous Output Current:	31.7A	31.7A
AC Max. Continuous Output Power:	6600W	7600W
AC Nominal Output Frequency:	60Hz	
AC Operating Frequency Range:	59.3 - 60.5Hz	
Output Power Factor:	0.99	

UL 1741		Integrated PV AFCI
CSA107.1	LISTED	Type 1
UL 1699B	240430	

This device complies with Part 15 of FCC Rules: Operation is subject to the following two conditions: (1) this device may not cause harmful interference and (2) this device must accept any interference received, including interference that may cause undesired operation.

Enclosure Type: NEMA 4  
Utility-Interactive, Transformerless Inverter  
Ambient Temp.: -25°C...+70°C, derating >50°C

--	--	--	--	--

SOLiViA7.6NAG4TL  
GOE47010005A  
Rev.: XX  
Date Code: YYWW  
S/N: LLLMMXXYYWZZZZZ

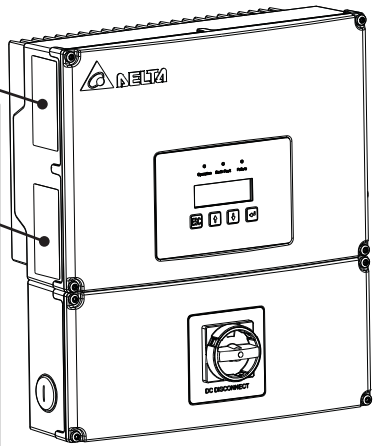
www.delta-americas.com/solarinverters.aspx  
Made in: China

**Figure 8: Location of type label**

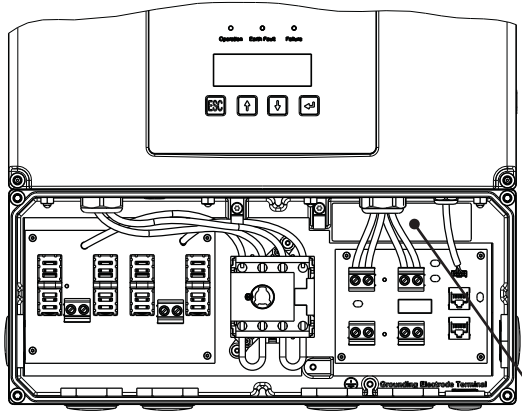
The type label is shown in figure 8. Different type labels can be found on the models SOLiViA 3.0 TL, 3.8 TL, 5.2 TL, 6.6 TL and 7.6 TL. The inverter serial number can be found on the type label. Please note that capital letters in Serial Number are used as placeholders to indicate the variable information for the SOLiViA 3.0 TL, 3.8 TL, 5.2 TL, 6.6 TL and 7.6 TL.

**CAUTION**  
 Risk of electric shock  
 Do not remove or destroy this label.  
 For connecting see manual.  
 Do not remove cover. No user serviceable parts inside. Refer servicing to qualified service personnel.  
 Both AC and DC voltage sources are minated inside this equipment. Disconnect each circuit individually before servicing.  
 When the photovoltaic array is exposed to light, it supplies DC voltage to the equipment.  
 Risk of electric shock from energy stored in capacitor. Do not remove cover until 5 minutes after disconnecting all sources of supply.  
**WARNING: ELECTRIC SHOCK HAZARD. THE DC CONDUCTORS OF THIS PHOTOVOLTAIC SYSTEM ARE UNGROUNDED AND MAY BE ENERGIZED.**  
**WARNING:** Electric Shock Hazard. The DC conductors of this photovoltaic system are normally ungrounded but will become intermittently grounded without indication when the inverter measures the PV array isolation.  
 Hot surfaces. To reduce the risk of burns, do not touch.

**MISE EN GARDE**  
 Risque de choc électrique  
 Ne pas enlever ou détruire cette étiquette.  
 Pour le raccordement voir le manuel.  
 Le boîtier ne doit en aucun cas être ouvert. Aucun composant interne n'est à entretenir. Reportez-vous à un technicien qualifié pour tout entretien.  
 Les deux sources de tension CA et CC sont reliées à l'intérieur de cet équipement. Débranchez chaque circuit individuel avant tout entretien.  
 Quand les panneaux photovoltaïques sont exposés à la lumière, ils fournissent une tension en courant continu à l'équipement.  
 Risque de choc électrique à partir d'énergie stockée dans les condensateurs. Retirer le couvercle du boîtier au moins 5 minutes après avoir débranché toutes les sources d'alimentation.  
**Attention:** Risque de choc électrique. Les conducteurs DC de ce système photovoltaïque ne sont pas fondées et peuvent être alimentés.  
**Attention:** Risque de choc électrique. Les conducteurs DC de ce système photovoltaïque sont normalement mis à la terre, mais deviendra intermittente terre sans indication lorsque le variateur mesure le photovoltaïque isolement.  
 Surface chaude. Pour réduire le risque de brûlures ne pas toucher.



The main caution labels in English and French are on the left side of the inverter.



**WARNING: MORE THAN ONE LIVE CIRCUIT. See diagram in manual**  
**AVERTISSEMENT: PLUSIEURS CIRCUITS SOUS TENSION. Voir le diagramme manuel**

The caution label located in the wiring box enclosure as shown above indicates that there is more than one live circuit.

Figure 9: Location of caution labels

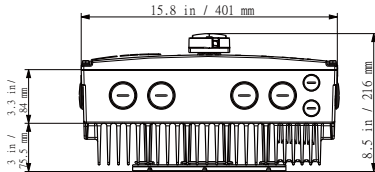
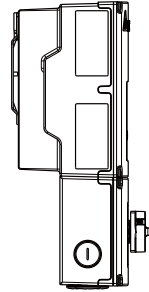
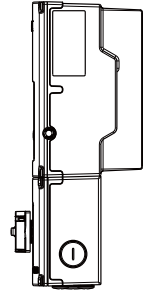
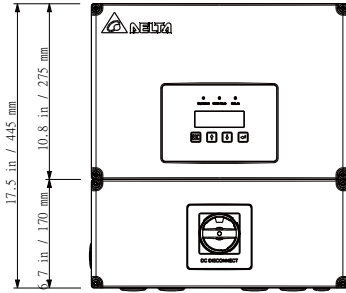


Figure 10: Dimensions of SOLIVIA 3.0 / 3.8 TL solar inverters

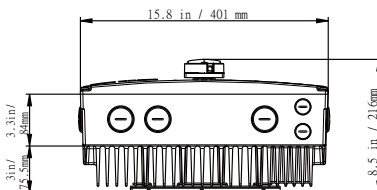
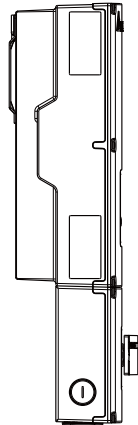
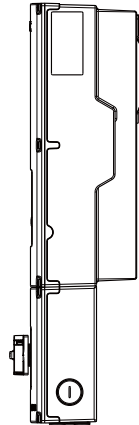
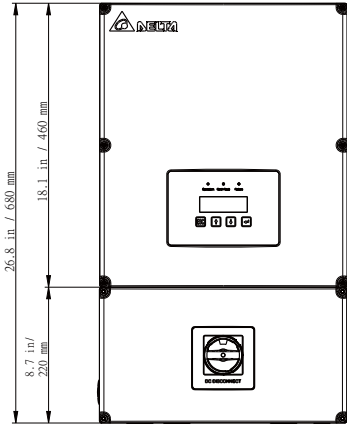
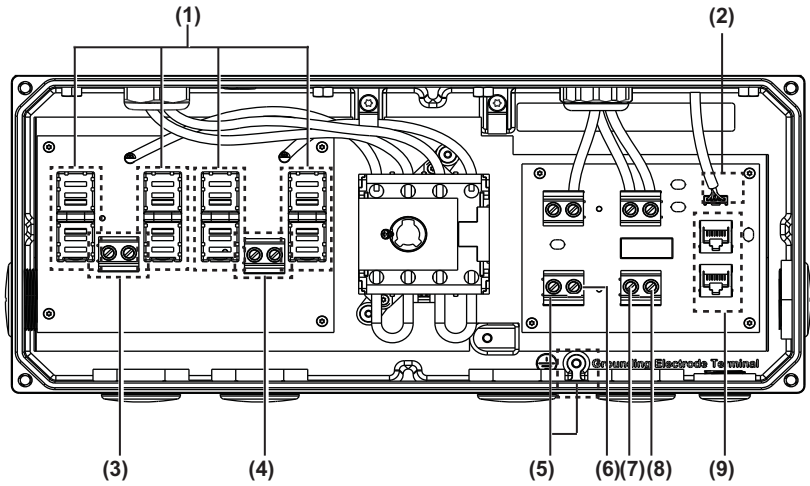
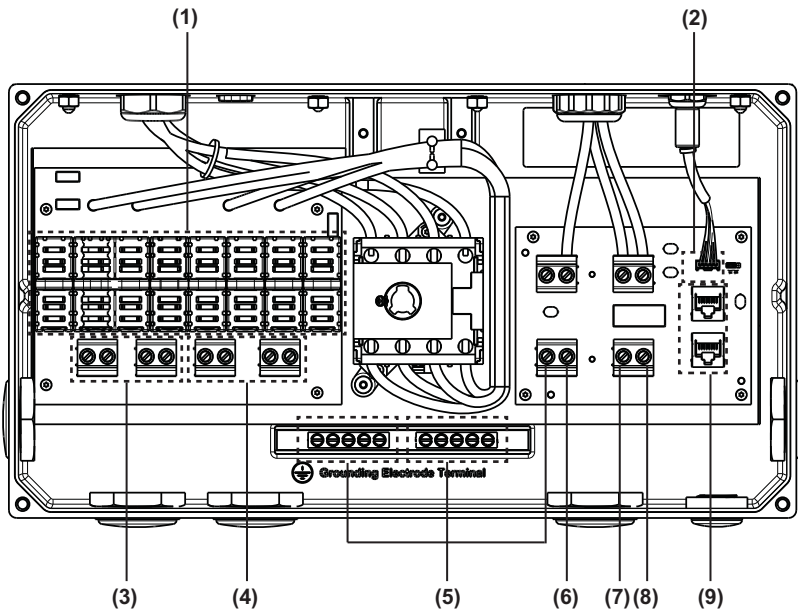


Figure 11: Dimensions of SOLIVIA 5.2 / 6.6 / 7.6 TL solar inverters



Wiring box of SOLIVIA 3.0 / 3.8 TL solar inverters



Wiring box of SOLIVIA 5.2 / 6.6 / 7.6 TL solar inverters

- |                                 |                               |
|---------------------------------|-------------------------------|
| (1) String Fuse Holders         | (6) AC side Neutral           |
| (2) RS485 Termination           | (7) AC side L2                |
| (3) PV Positive Terminals       | (8) AC side L1                |
| (4) PV Negative Terminals       | (9) RS485 communication ports |
| (5) AC side Grounding Terminals |                               |

Figure 12: Wiring box connection options

## Required torques for wiring box terminals

Terminals in Figure 12	Wire size permitted	Required torque*
3, 4, 5, 6, 7, 8 (see location and description above)	14 - 6 AWG (2.5 - 16 mm <sup>2</sup> )	10.5 in-lbs (1.2 Nm)

**Table 1: Required torques for wiring box terminals**

\* Exception: Specified torque marked on the terminal block.

## 3 Installation



Read all of these instructions, cautions, and warnings for the Delta SOLIVIA inverter and associated PV array documentation.

Lisez toutes les instructions, rubriques Prudence et Avertissement de l'onduleur Delta SOLIVIA, ainsi que la documentation sur le panneau photovoltaïque associé.



Installation and commissioning must be performed by a licensed electrician in accordance with local, state, and National Electrical Code ANSI/NFPA 70 requirements.

L'installation et la mise en service doivent être effectuées par un électricien autorisé conformément aux exigences locales et nationales ainsi qu'au National Electrical Code ANSI/NFPA 70.



The installation and wiring methods used in the installation of this inverter in the U.S. must comply with all US National Electric Code requirements (NEC) and local AHJ inspector requirements. In Canada, the installation and wiring methods used must comply with the Canadian Electric Code, parts I and II, and the local AHJ inspector requirements. System grounding when required by the Canadian Electrical Code, Part 1, is the responsibility of the installer.

Les méthodes d'installation et de câblage utilisées lors de l'installation de cet onduleur aux États-Unis doivent être conformes à toutes les exigences du National Electric Code (NEC) nord-américain et à celles des services d'inspection locaux de l'AHJ. Au Canada, les méthodes d'installation et de câblage utilisées doivent être conformes au Canadian Electric Code, parties I et II et aux exigences des services d'inspection locaux l'AHJ. L'installateur est responsable de la mise à terre du système lorsque requise par le Canadian Electrical Code, Partie 1.



These servicing instructions are for use by qualified personnel only. To reduce the risk of electric shock, refer all servicing to factory qualified service personnel. No user service parts are contained inside the inverter.

Les instructions concernant la maintenance sont destinées à être utilisées uniquement par un personnel qualifié. Afin de réduire les risques de choc électrique, contactez le personnel d'entretien qualifié de l'usine à propos des opérations d'entretien. L'onduleur ne comporte aucune pièce pouvant être réparée par l'utilisateur.



The secondary short-circuit current rating is increased at the transfer connection point to the public electricity supply system by the nominal current of the connected solar inverter.

Le courant nominal secondaire du court-circuit est augmenté au point de connexion du transfert vers le réseau électrique public par le courant nominal de l'onduleur solaire connecté.



To reduce the risk of fire, connect only to a circuit provided with branch circuit overcurrent protection in accordance with the National Electrical Code, ANSI/NFPA70.

Afin de réduire les risques d'incendie, effectuez une connexion uniquement avec un circuit équipé d'une protection contre les surintensités des circuits de dérivation, conformément au National Electrical Code, ANSI/NFPA70.



This unit or system is provided with fixed trip limits and shall not be aggregated above 30KW on a single point of common connection.

Cet appareil ou système est fourni avec des limites de déclenche fixes et ne doit pas être agrégé au-dessus de 30KW sur un seul point de connexion commun.



In order to be able to carry out an energy measurement, a KWH revenue meter must be attached between the networks feed-in point and the solar inverter.

Afin de pouvoir mesurer la quantité d'énergie électrique consommée, un compteur électrique (kWh) devra être installé entre le point d'entrée du réseau d'alimentation et l'onduleur solaire.

### 3.1 Visual inspection

All Delta SOLIVIA inverters are 100% tested, packaged in a heavy duty cardboard shipping carton, and visually inspected before leaving our manufacturing facility. If you receive the inverter in a damaged shipping carton, please reject the shipment and notify the shipping company.

Verify Delta SOLIVIA shipping carton contains:

- a. Correct Delta SOLIVIA inverter model: SOLIVIA 3.0 TL, SOLIVIA 3.8 TL, SOLIVIA 5.2 TL, SOLIVIA 6.6 TL or SOLIVIA 7.6 TL
- b. Mounting plate
- c. Operation and installation manual

Visually inspect the Delta SOLIVIA inverter for any physical damage such as a bent heatsink fin and dented chassis.

If the inverter appears to be damaged or if the inverter needs to be returned, please contact your local Delta representative.



**No user serviceable parts are contained in the inverter section.**

Do not attempt to open or repair the inverter. The inverter section is factory sealed to maintain its NEMA 4 rating and will void the inverter warranty.



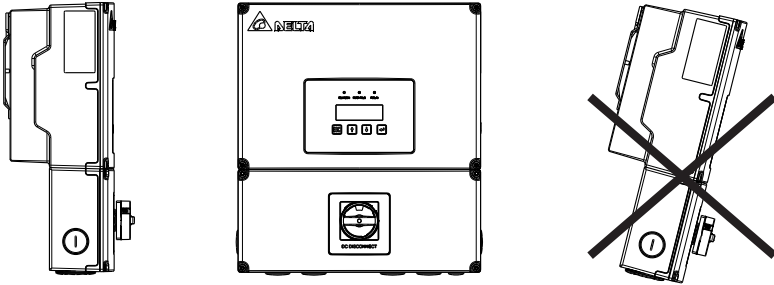
Ne tentez pas d'ouvrir ou de réparer l'onduleur. La section de l'onduleur est scellée en usine afin qu'elle conserve son courant nominal NEMA 4, son ouverture annulerait la garantie.

### 3.2 Installation location

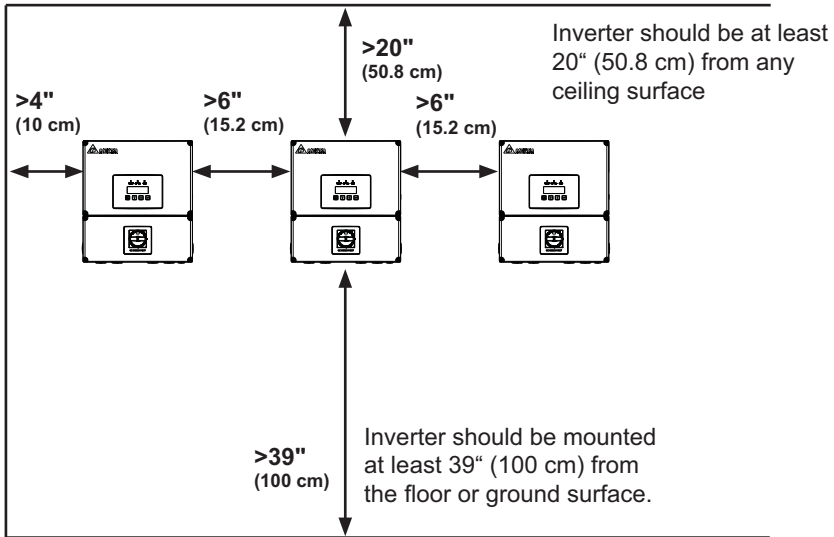
1. Install the inverter on a non-flammable support base.
2. The inverter must be mounted vertically on a flat surface.
3. A minimum distance of 6 inches (15.2 cm) of unobstructed clearance on all sides to promote free convection is required.
4. Ensure the mounting hardware and structure can support the weight of the inverter.
5. Ensure the mounting hardware meets the appropriate building code.
6. Avoid installation on resonating surfaces (light construction walls etc.).
7. Installation can be indoors or in protected outdoor areas.
8. Avoid direct sun exposure.
9. Ensure inverter ambient temperature is within -13°F to +122°F (-25°C to +50°C) for optimal efficiency of the PV system.
10. Chose a mounting height for easy viewing of the display.
11. Despite having a NEMA 4 / IP65 enclosure with a soiling category III certification, the inverter must not be exposed to heavy soiling.
12. Unused connectors and interfaces must be covered through sealing connectors.



### 3.3 Mounting the inverter

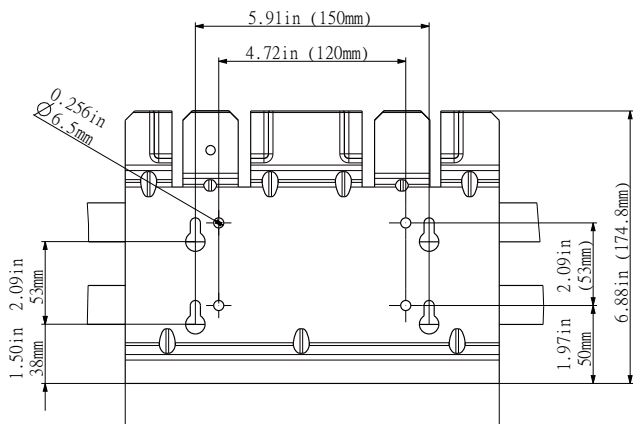


Please make sure the inverter is installed vertically, especially if it is to be installed outdoors.



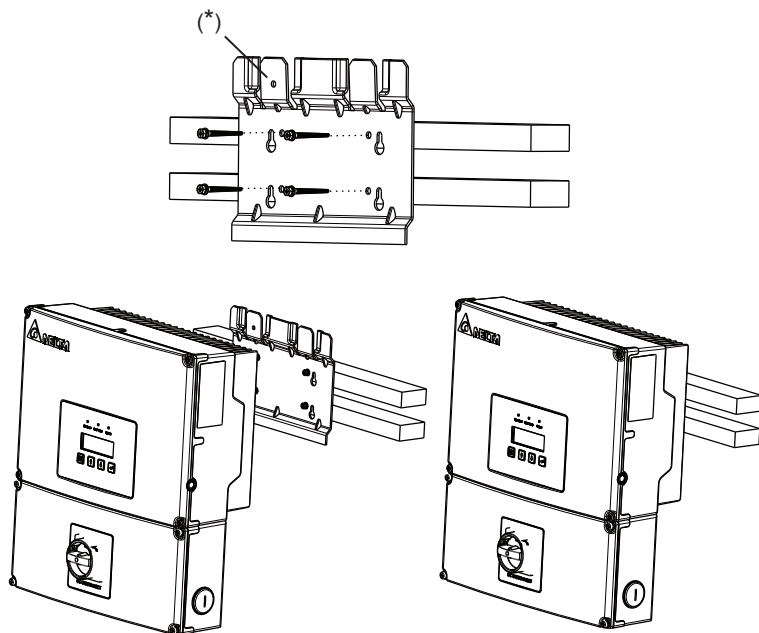
**Figure 13: Inverter clearances**

The National Electric Code may require significant larger working clearances (see NEC Section 110.26)



**Figure 14: Dimension drawing of mounting plate**

1. Mount the mounting plate to the wall with at least 4 screws and anchors ( $\varnothing$  6mm). With 4 screws use 4 holes A or 4 holes B (see Figure 14). You can use the mounting plate as a template for marking the positions of the boreholes.
2. Tighten the screws firmly to the wall.



**Figure 15: Installing the plate and inverter on a wood stud wall**

(\*) This hole is provided as the permanently fixed hole.

1. Using the mounting plate as a template, mark four screw holes onto the wall. For 16 in. (40.6 cm) on center stud mounting, use the four holes that are indicated for this purpose in the figure. Make sure the holes are in the center of each stud before marking the drill location.
2. After marking the screw hole locations, drill the pilot holes for the appropriate screw type that will hold the weight of the inverter in the selected material. 1/4" lag bolts are recommended for mounting on wood framed walls.
3. Align the mounting plate over the pilot holes and install the mounting hardware to 3/16 inches flush to mounting surface. Please tighten to the recommended torque necessary to hold the mounting plate firmly to the wall surface type.
4. As the solar inverters are heavy, SOLIVIA 3.0 TL/3.8 TL weigh 43.0 lbs. (19.5 kg.) and SOLIVIA 5.2 TL/6.6 TL/7.6 TL weigh 65 lbs.(29.5 kg.), they should be lifted out of the cardboard container by at least two persons.
5. With at least two persons on either side of the inverter, lift it up and place it carefully onto the mounting plate. Install two locking nuts as shown in the figure 15 to secure the device.
6. Check that the solar inverter is seated securely on the wall.

It is recommended to use stainless steel screws, especially if installed outdoors. Be sure to verify sheer and pullout strength of anchors or other wall attachments.

### 3.4 Required torques for SOLIVIA NA solar inverters

Part	Description	Required torque
Wiring Box Cover Screws	T30 screws (x4) for attaching the wiring box cover to the wiring box	max. 71 in-lbs (8 Nm)
Wiring Box Interior Nuts	10mm nuts (x4) that secure the wiring box to the inverter stage assembly	max. 71 in-lbs (8 Nm)

**Table 2: Required Torques for SOLIVIA NA solar inverters**

## 4 Electrical connections

### 4.1 General safety



Read all of these instructions, cautions, and warnings for the Delta SOLIVIA inverter and associated PV array documentation.

Lisez toutes les instructions, rubriques Prudence et Avertissement de l'onduleur Delta SOLIVIA, ainsi que la documentation sur le panneau photovoltaïque associé.



Installation and commissioning must be performed by a licensed electrician in accordance with local, state, and National Electrical Code ANSI/NFPA 70 requirements. Use 10 AWG or greater 90°C (194 °F), copper solid or stranded wire for all DC and AC wiring to the Solivia inverter to optimize system efficiency.

L'installation et la mise en service doivent être effectuées par un électricien autorisé conformément aux exigences locales et nationales ainsi qu'au National Electrical Code ANSI/NFPA 70. Afin d'optimiser l'efficacité du système, utilisez au moins 10 fils en cuivre torsadé ou solide à 90°C (194 °F), pour l'ensemble du câblage en CC ou en CA vers l'onduleur SOLIVIA.



PV solar arrays produce hazardous voltages and currents when exposed to light which can create an electrical shock hazard. Using dark opaque sheets cover the PV solar array before wiring or connecting cable terminations.

Les panneaux solaires photovoltaïques produisent tensions et courants dangereux lorsqu'ils sont exposés à la lumière et constituent un danger de choc électrique. Couvrez le panneau solaire photovoltaïque à l'aide de morceaux de tissu opaques et foncés avant tout câblage ou connexion des terminaisons de câble.



Before connecting the Delta SOLIVIA inverter to the AC distribution grid, approval must be received by appropriate local utility as required by national and state interconnection regulations, and must be connected only by qualified personnel.

Avant de connecter l'onduleur solaire Delta SOLIVIA au réseau de distribution du courant alternatif (CA), une autorisation doit être obtenue de la part des services publics locaux de tutelle, conformément aux règlements concernant l'interconnexion nationale et locale. La connexion ne doit être effectuée que par un personnel qualifié.



Do not attempt to open or repair the inverter as the inverter is factory sealed to maintain its NEMA 4 / IP65 rating and will void the inverter warranty.

Ne tentez pas d'ouvrir ou de réparer l'onduleur. La section de l'onduleur est scellée en usine afin qu'elle conserve son courant nominal NEMA 4, son ouverture annulerait la garantie.



The PV AC output circuits are isolated from the enclosure. The PV system Ground Electrode Conductor (GET) when required by National Electric Code (NEC), ANSI/NFPA 70 Sections 690.41, 690.42, and 690.43 is the responsibility of the installer.

Les circuits d'entrée et de sortie de cette unité sont isolés du boîtier. La mise à la terre du système doit être effectuée conformément au National Electrical Code (NEC), ANSI/NFPA 70 Sections 690.41, 690.42, and 690.43, et l'installateur est responsable de cette mise en conformité.

#### 4.2 Utility AC voltage

The Delta SOLIVIA inverters are grid-tied to the public utility. Delta NA inverters are software configurable via the user display panel for various 208 Vac or 240 Vac 60 Hz public utility grid as shown in figures 16-22.



The Delta SOLIVIA NA Inverters should never be connected to a 120 Vac utility service. NEC 690.64(b)(1) requires that the inverter be connected to a dedicated circuit with no other outlets or devices connected to the same circuit.

Les onduleurs nord-américains Delta SOLIVIA ne doivent jamais être connectés à un service d'électricité publique de 120 Vca. NEC 690.64(b)(1) exige que l'onduleur soit connecté à un circuit dédié ne comportant aucune autre sortie ou aucun autre dispositif connecté(e) au même circuit.

#### AC connection voltage and frequency limits:

Voltage range for 208 V nominal, line to line	185 V - 226 V
Voltage range for 240 V nominal, line to line	213 V - 262 V
Frequency Range	59.3 Hz - 60.5 Hz

Table 3: AC connection voltage and frequency limits

#### Public grid configurations allowed:

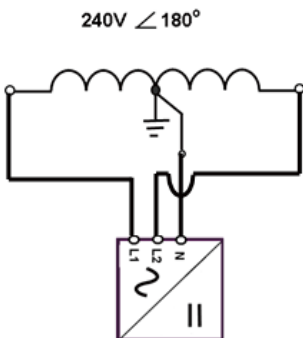


Figure 16: 240V / 120V Split Phase AC Grid

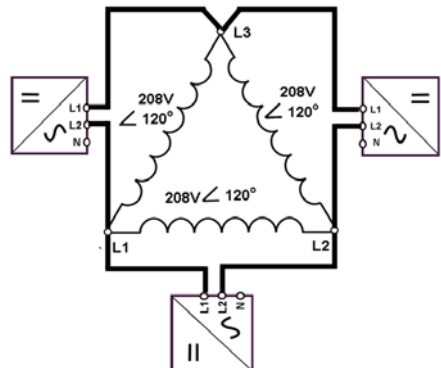


Figure 17: 208V Delta AC Grid

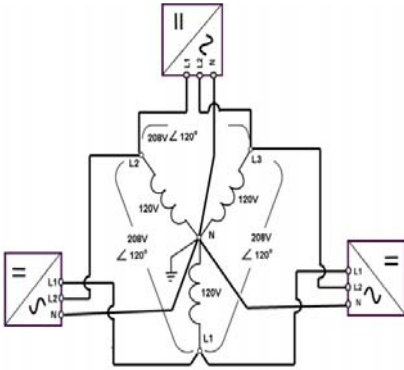


Figure 18: 208V / 120V WYE AC Grid

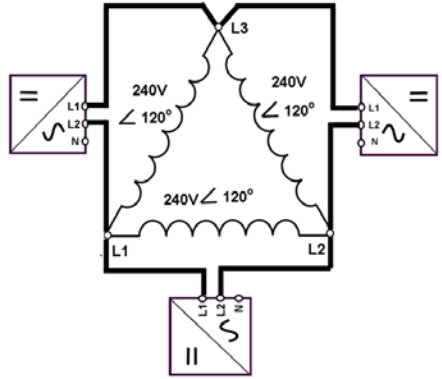


Figure 19: 240V Delta AC Grid

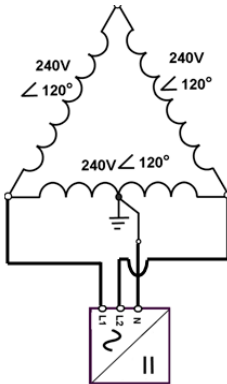


Figure 20: 240V / 120V Stinger AC Grid

**Public Grid Configurations NOT Allowed:**

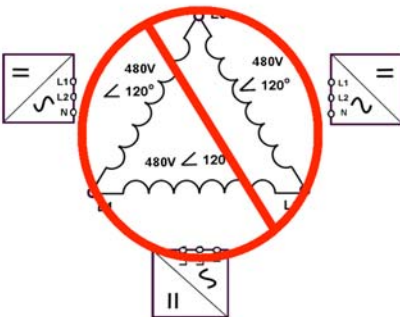


Figure 21: 480V Delta AC Grid

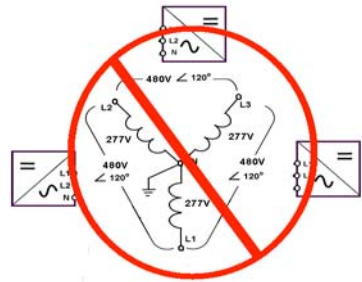


Figure 22: 480V / 277V WYE AC Grid

### 4.3 AC circuit breaker requirements

A dedicated circuit breaker in the building circuit panel is required for each Delta SOLIVIA inverter that is installed. There should be a circuit breaker or fuse to protect each AC line, L1 and L2. The circuit breaker should be able to handle the rated maximum output voltage and current of the inverter. Please refer to the table below to determine the appropriate circuit breaker size to avoid potential fire hazards. The National Electrical Code (NEC), ANSI/NFPA 70 or applicable local electrical codes must be followed when determining maximum branch-circuit over-current protection requirements.

Inverter model	Recommended AC branch protection
SOLIVIA 3.0 TL	2-pole, 20 A 240 Vac
SOLIVIA 3.8 TL	2-pole, 20 A 240 Vac
SOLIVIA 5.2 TL	2-pole, 40 A 240 Vac
SOLIVIA 6.6 TL	2-pole, 40 A 240 Vac
SOLIVIA 7.6 TL	2-pole, 40 A 240 Vac

Please note that there is an exception to the requirement of a dedicated circuit breaker in the building circuit panel for each inverter if there exists a dedicated PV system AC subpanel that is used to combine multiple inverters. In this case, only one breaker at the main building service panel should be installed for a multiple inverter installation utilizing a dedicated PV system AC subpanel.

### 4.4 Grounding electrode conductor (GET)

Per NEC 690.47, a Grounding Electrode Conductor must be installed, and the GET conductor must be sized in accordance with NEC article 250.166. The GET conductor should be terminated at the GET screw terminal inside the wiring box compartment.

### 4.5 Lightning and surge protection

Delta SOLIVIA NA inverters are designed and certified to meet stringent UL 1741 / IEEE 1547 and ANSI/ IEEE 62.41/62.42 AC lightning and surge requirements; however, every PV installation is unique, thus additional external UL/NEC AC and DC surge protection and solid grounding practice is recommended

### 4.6 Multiple inverters

Multiple Delta SOLIVIA inverters are permitted at a common location if all applicable NEC, state, local building codes and local utility commissioning guidelines are met. In addition, each inverter should have its own dedicated AC branch protection circuit breaker and a dedicated PV string/array, not to exceed the inverter's ratings.

## 4.7 PV string considerations

There are a large number of PV module string combinations that will offer optimal performance from either the SOLIVIA 3.0 TL, SOLIVIA 3.8 TL, SOLIVIA 5.2 TL, SOLIVIA 6.6 TL or SOLIVIA 7.6 TL inverters thanks to its wide full power MPP range (200 V – 500 V).



Follow the temperature multiplication factors given in NEC 690.7 table and the PV module manufacturer specified V/Temp coefficient to ensure PV string voltage is less than < 600 Vdc. Maximum inverter PV input voltage for all possible weather conditions in the location of installation.

Respectez les facteurs de multiplication de température énoncés dans le tableau NEC 690.7 ainsi que le coefficient Tension/Température spécifié par le fabricant du module PV afin de garantir que la tension de chaîne PV soit inférieure à 600 Vcc. Cette valeur correspondra à la tension d'entrée maximale PV de l'onduleur pour toutes conditions météorologiques éventuelles au niveau de l'emplacement d'installation.



System wiring voltage losses should be no greater than 1 to 2 percent for optimal system efficiency and performance.

Les pertes de tension du câblage du système ne doivent pas dépasser 1 à 2% pour une efficacité et une performance optimales du système.

## 4.8 Inverter connections

### 4.8.1 General information



Installation and commissioning must be performed by a licensed electrician in accordance with local, state, and National Electrical Code ANSI/NFPA 70 requirements.

L'installation et la mise en service doivent être effectuées par un électricien autorisé conformément aux exigences locales et nationales ainsi qu'au National Electrical Code ANSI/NFPA 70.



Inputs and output circuits of this unit are isolated from the enclosure. System grounding must be done in accordance with the National Electrical Code (NEC), ANSI/NFPA 70 and Compliance is the responsibility of the installer.

Les circuits d'entrée et de sortie de cette unité sont isolés du boîtier. La mise à la terre du système doit être effectuée conformément au National Electrical Code (NEC), ANSI/NFPA 70, et l'installateur est responsable de cette mise en conformité.





Ensure no live voltages are present on PV input and AC output circuits, and verify that the DC disconnect, AC disconnect, and dedicated AC branch circuit breaker are in the “OFF” position, before inverter installation.

Assurez-vous qu'aucune tension directe n'est présente sur les circuits photovoltaïques d'entrée et de sortie du CA, vérifiez que le CC et le CA sont déconnectés, et que le disjoncteur de dérivation dédié est sur position “OFF”, avant de procéder à l'installation de l'onduleur.



PV solar arrays produce hazardous voltages and currents when exposed to light which can create an electrical shock hazard. Using dark opaque sheets cover the PV solar array before wiring or connecting cable terminations

Les panneaux solaires photovoltaïques produisent tensions et courants dangereux lorsqu'ils sont exposés à la lumière et constituent un danger de choc électrique. Couvrez le panneau solaire photovoltaïque à l'aide de morceaux de tissu opaques et foncés avant tout câblage ou connexion des terminaisons de câble.



Before any electrical wiring can be connected to the inverter, the inverter must be permanently mounted.

Avant tout connexion de câblage électrique à l'onduleur, ce dernier doit être assemblé de manière définitive.



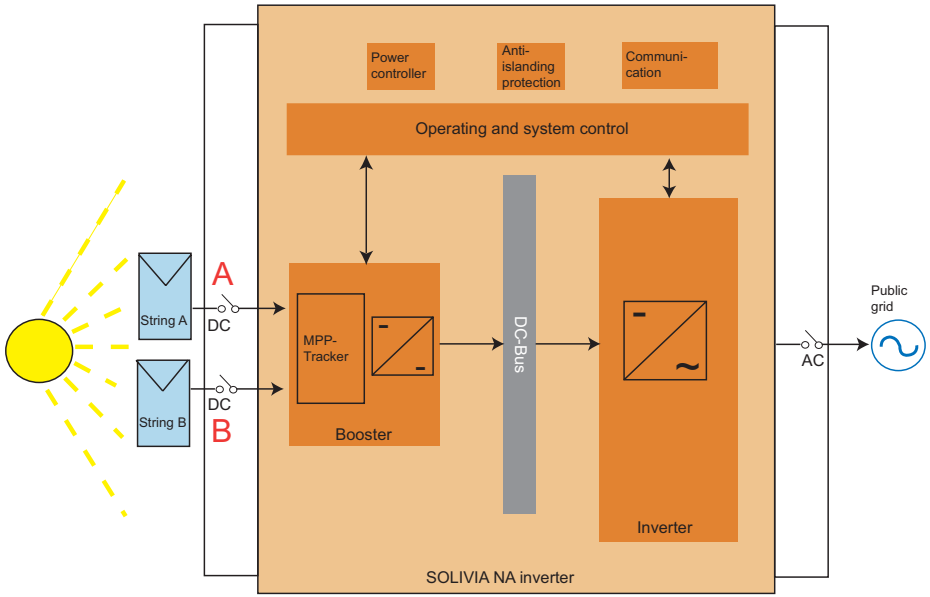
Use solid or stranded copper conductors only.  
6 AWG (16 mm<sup>2</sup>) is maximum allowed wire size.

Utilisez uniquement des conducteurs en cuivre torsadés ou solides.  
La taille maximum de câble autorisée est de 6 AWG (16 mm<sup>2</sup>).

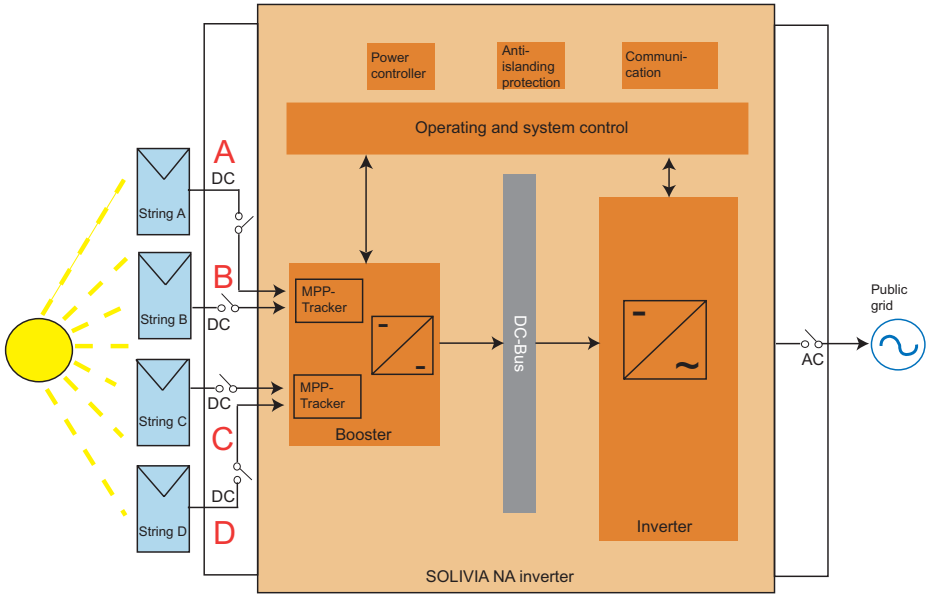


Inverter warranty is VOID if the DC input voltage exceeds the inverter 600 Vdc maximum.

La garantie de l'onduleur devient NULLE si la tension d'entrée du CC dépasse le maximum de 600 Vcc de l'onduleur.



**Figure 23: SOLVIA 3.0 / 3.8 TL Inverter electrical diagram**



**Figure 24: SOLVIA 5.2 / 6.6 / 7.6 TL Inverter electrical diagram**



POWER FED FROM MORE THAN ONE SOURCE, MORE THAN ONE LIVE CIRCUIT. Please note that all DC and AC terminals may carry current even without connected wires.

Alimentation puissance provenant de plus d'une source, plus d'un circuit vivant. Veuillez noter que toutes les terminaux CC et CA peuvent transporter le courant, même sans fils reliés.

#### 4.8.2 Opening the wiring box cover



Ensure no live voltages are present on PV input and AC output circuits, and verify that the DC disconnect, AC disconnect, and dedicated AC branch circuit breaker are in the "OFF" position, before inverter installation.

Assurez-vous qu'aucune tension directe n'est présente sur les circuits photovoltaïques d'entrée et de sortie du CA, vérifiez que le CC et le CA sont déconnectés, et que le disjoncteur de dérivation dédié est sur position "OFF", avant de procéder à l'installation de l'onduleur.

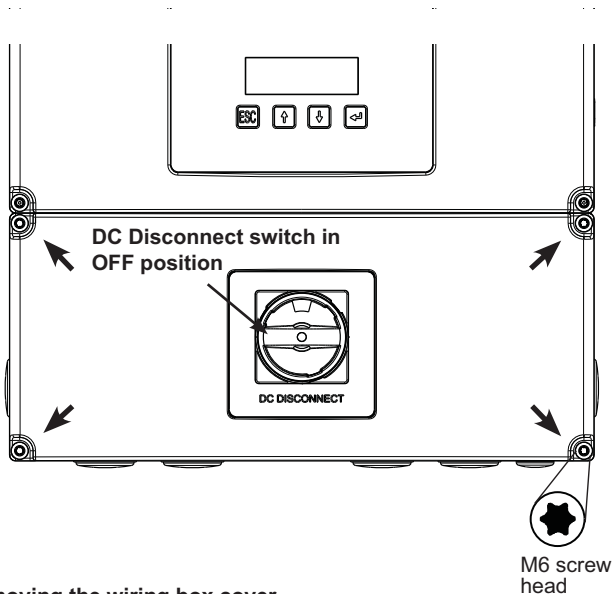


Figure 25: Removing the wiring box cover

1. Place DC Disconnect switch in "OFF" position. Please note the cover cannot be removed when the DC Disconnect switch is in the "ON" position.
2. Remove the 4 cover screws indicated above with a T30 Torx screw driver
3. Lift the cover upward and place off to the side.

### 4.8.3 Wiring box conduit plugs

Conduit plugs are provided for 1 inch and ½ inch conduit fittings. If conduit fitting used is between 1 inch and ½ inch (2.54 cm and 1.27 cm), an appropriate conduit reducer should be used.

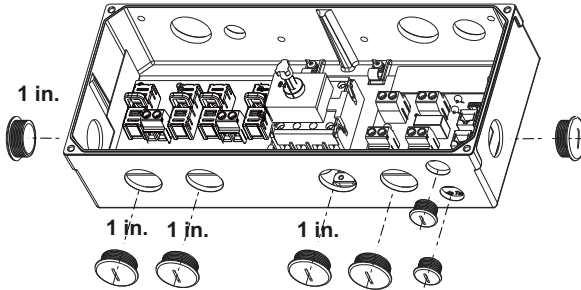
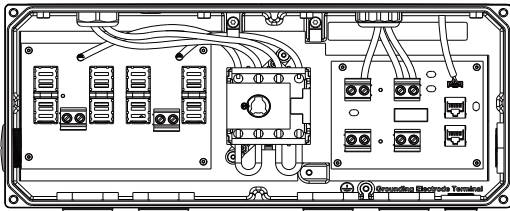


Figure 26: Locations of wiring box conduit plugs



Do not enlarge the wiring compartment conduit openings as the wiring box enclosure will be damaged which will void the inverter warranty.

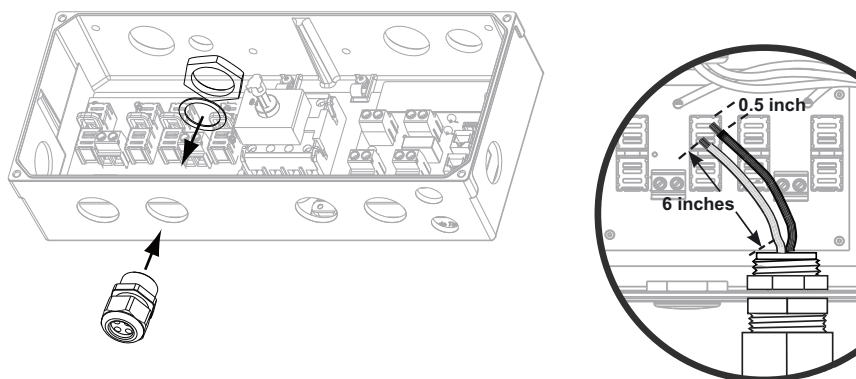
N'élargissez pas les ouvertures du conduit du compartiment de câblage, boîtier de câblage risque d'être endommagé et la garantie de l'onduleur invalidée.



The conduit plugs are removed by placing a flat blade screwdriver in the slot on the conduit plug face and turning while gripping the nut on the inside of the enclosure to ensure it does not slip. Unscrew the nut from the conduit plug and slip the conduit plug out of the conduit opening.



Figure 27: Wiring box conduit plug removal (illustration showing the removal of a conduit plug)



**Figure 28: Conduit installation and wiring routing**

Conduit fittings need to be water tight with either NEMA 4, 4X, 6, or 6X rated, and insulated type preferred.

Once conduit and fittings are installed, route wiring thru conduit and fitting and allowing a 6 inch strain relief loop within the wiring box compartment.

#### 4.8.4 PV array string input connections



To ensure maximum protection against hazardous contact voltages while assembling photovoltaic installations, both the positive and the negative leads must be strictly isolated electrically from the protective ground potential (PE).

Afin d'assurer une protection maximale contre les tensions dont le contact est dangereux lors du montage des installations photovoltaïques, les câbles positifs et négatifs doivent être strictement isolés électriquement de la mise à la terre (PE).



Verify DC conductor voltage polarity with voltage meter because damage to the inverter could result if incorrect DC input polarity is connected.

Vérifiez la polarité des tensions du conducteur de courant direct à l'aide d'un voltmètre, une connexion incorrecte de polarité d'entrée du CC est susceptible d'endommager l'onduleur.

Risk of damage. Be sure that the polarity is correct when you make the connection. Connecting it wrongly will cause damage to the inverter.

Risque d'endommagement. Assurez-vous que la polarité est correcte lorsque vous effectuez la connexion. Une mau vaise connexion est susceptible d'endommager l'onduleur.



Risk of electric shock and fire. Use only with PV modules with a maximum system voltage of rating of 600V or Higher.

Risque de choc électrique et d'incendie. Utilisez uniquement des modules photovoltaïques avec une tension maximale du système de 600V ou supérieur.

Electric shock hazard. The DC conductors of this photovoltaic system are ungrounded and may be energized.

Hasard de choc électrique. Les conducteurs CC de ce système photovoltaïque ne sont pas mis à la terre et peuvent être alimentés.

Electric shock hazard. The DC conductors of this photovoltaic system are ungrounded but will become intermittently grounded without indication when the inverter measures the PV array isolation.

Hasard de choc électrique. Les conducteurs CC de ce système photovoltaïque ne sont pas mis à la terre, mais deviendront par intermittence à la terre sans indication lorsque l'onduleur mesure l'isolement du générateur photovoltaïque.



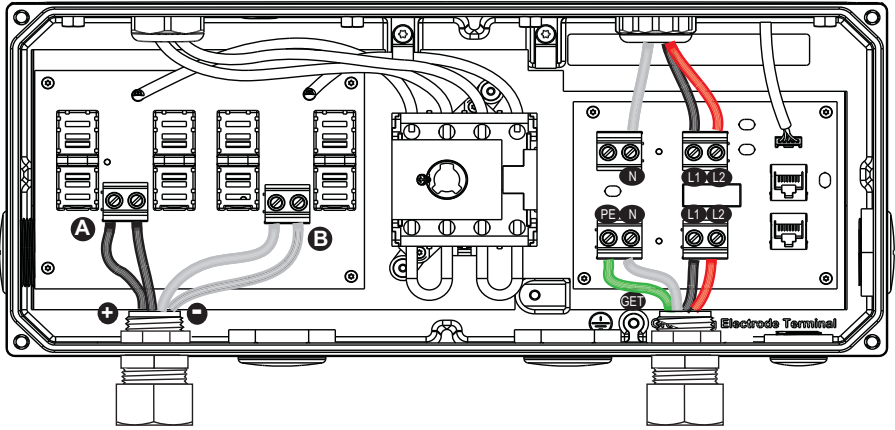
The PV Array positive or negative leads must not be connected to ground before the inverter!

Les fils du positif ou du négatif du groupe solaire PV ne devront jamais être reliés à la terre avant l'onduleur !



All screw terminals accept solid or stranded copper 14 – 6 AWG wire only. A 3.5 mm flat blade screw driver is recommended for tightening screw terminals to a 10.5 in-lbs. (1.2 Nm) torque.

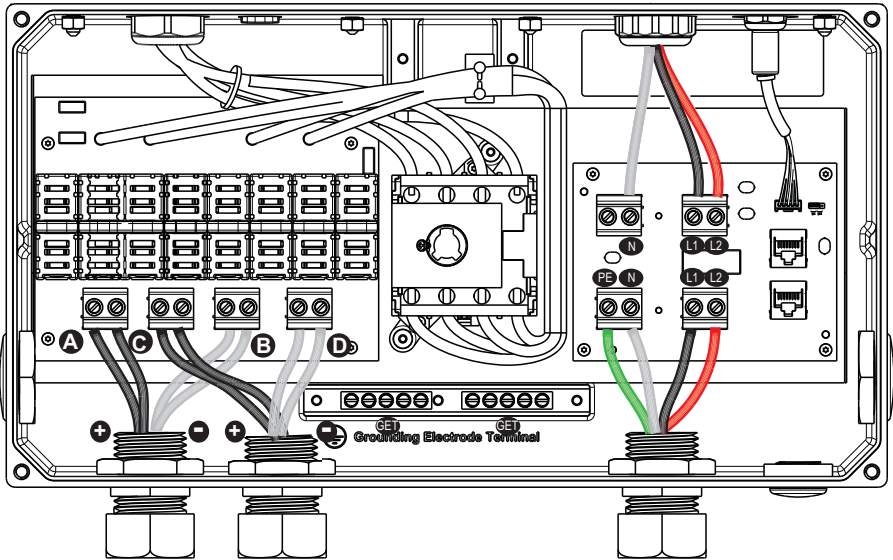
Toutes les bornes à vis n'acceptent que les fils de cuivre rigides ou souples de 14 – 6 AWG. Il sera recommandé d'utiliser un tournevis plat de 3,5 mm pour serrer les bornes à vis à un couple de 1,2 Nm (10,5 in-lbs).



**A** PV\_Positive Terminals

**B** PV\_Negative Terminals

**Wiring box of SOLIVIA 3.0 / 3.8 TL solar inverters**



**A** PV1\_Positive Terminals

**B** PV1\_Negative Terminals

**C** PV2\_Positive Terminals

**D** PV2\_Negative Terminals

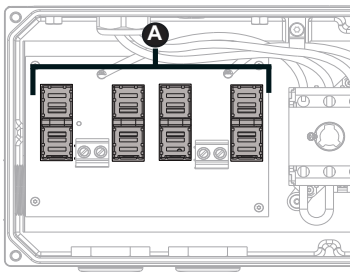
**Wiring box of SOLIVIA 5.2 / 6.6 / 7.6 TL solar inverters**

**Figure 29: Wiring box - PV input connections**

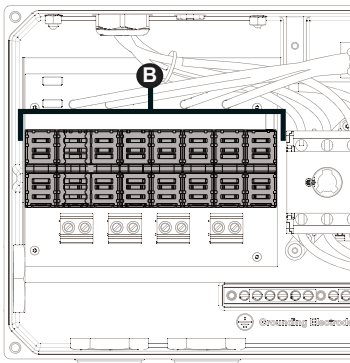
1. Verify that the exposed wires are at least 6 inches in length to provide adequate strain relief and wire end strip length required. Secure the conduit into both fittings then tighten conduit fittings to manufacturer's recommended torque.
2. Connect the positive lead from each PV array string to PV\_Positive Terminals (A / C) in the wiring box compartment. Using a 3.5 mm flat blade screw driver tighten the screw terminal to 10.5 in-lbs (1.2 Nm) of torque.
3. Connect the negative lead from each PV array string to PV\_Negative Terminals (B / D) in the wiring box compartment. Using a 3.5 mm flat blade screw driver tighten the screw terminal to 10.5 in-lbs (1.2 Nm) of torque.
4. Verify inverter to wiring box compartment connections DC wiring board assembly:
  - Positive wire goes to "PV\_Positive" Terminal **A** **C**
  - Negative wire goes to "PV\_Negative" Terminal **B** **D**

**Note:** In SOLIVIA 5.2 / 6.6 / 7.6 TL inverters, if the PV array contains more than 3 PV module strings then an external PV combiner is recommended.

#### 4.8.5 Selecting PV string fuse(s)



**A** = 4 String Fuse Holders (black) of SOLIVIA 3.0 / 3.8 TL inverters



**B** = 8 String Fuse Holders (black) of SOLIVIA 5.2 / 6.6 / 7.6 TL inverters

**Figure 30: Location of string fuse**



#### 4.8.5.1 PV string fuse information and calculating string fuse size

The SOLIVIA 3.0 TL and SOLIVIA 3.8 TL inverters are shipped with 4 X 15 A 600Vdc Littelfuse KLKD 15 string fuses. The SOLIVIA 5.2 TL, SOLIVIA 6.6 TL and SOLIVIA 7.6 TL inverters are shipped with 8 X 15 A 600Vdc Littelfuse KLKD 15 string fuses. The provided string fuses may or may not be appropriate for your particular installation. Proper sizing of overcurrent protection is based on the maximum short circuit current  $I_{sc}$  (module) and calculated in accordance with NEC Article 690 requirements.



The maximum acceptable string fuse for the SOLIVIA Inverter is 20 A (KLKD 20). Use of larger fuses will void the warranty.

L'ampérage maximal admissible pour le fusible de chaîne de l'onduleur SOLIVIA est de 20 A (KLKD 20). L'utilisation de fusibles d'ampérage plus élevé annulera la garantie.



The string fuse rating should never exceed the Maximum Series Fuse Rating provided by the module manufacturer. This value is typically listed on the module label.

L'ampérage du fusible de chaîne ne devra jamais dépasser la valeur maximale fournie par le fabricant du module pour les fusibles en série. Cette consigne sera généralement indiquée sur l'étiquette du module.

##### 4.8.5.1.1 Calculating the minimum string fuse per NEC Article 690

The minimum string fuse size is calculated by multiplying the module  $I_{sc}$  x 1.56.

Thus, if we are using modules that have an  $I_{sc}$  = 6.25 A, we would calculate our minimum string fuse size as follows:

**String Fuse (minimum) = 6.25 A x 1.56 = 9.75 A**

Reviewing our Littelfuse KLKD series fuses, we find that 10 A is the next available fuse size. Thus, to satisfy the minimum string fuse requirements per NEC Article 690, please remove the 15 A fuses shipped with the inverter and replace them with 10 A fuses.

A partial listing of the Littelfuse KLKD Fuses is as shown.

Part Number	Amperage
KLK D 008. ....	8 A
KLK D 009. ....	9 A
KLK D 010. ....	10 A
KLK D 012. ....	12 A
KLK D 015. ....	15 A
KLK D 020. ....	20 A

It is worth noting that for this example we calculated the minimum series fuse rating. However, it may be appropriate to use the supplied 15 A fuses insofar as they do not exceed the maximum series fuse rating (provided by the module manufacturer) or the overcurrent protection requirements of your PV source wires. Please reference the appropriate NEC Article(s) for further discussion regarding proper sizing of overcurrent protection

#### 4.8.5.1.2 Generic fuse properties

Other fuse manufacturers may have compatible fuse types. The generic properties are:

- Fast-acting
- Dimensions: 1 1/2" in length x 13/32" fuse diameter
- Interrupt Rating:  $\geq 10$  kA @ 600 Vdc
- UL and CSA approval of the fuse is mandatory
- String fuses can be sized from 1 A to max. 20 A and rated for 600 Vdc. Please see above sec for calculating string fuse size.

#### 4.8.5.2 String fuse replacement



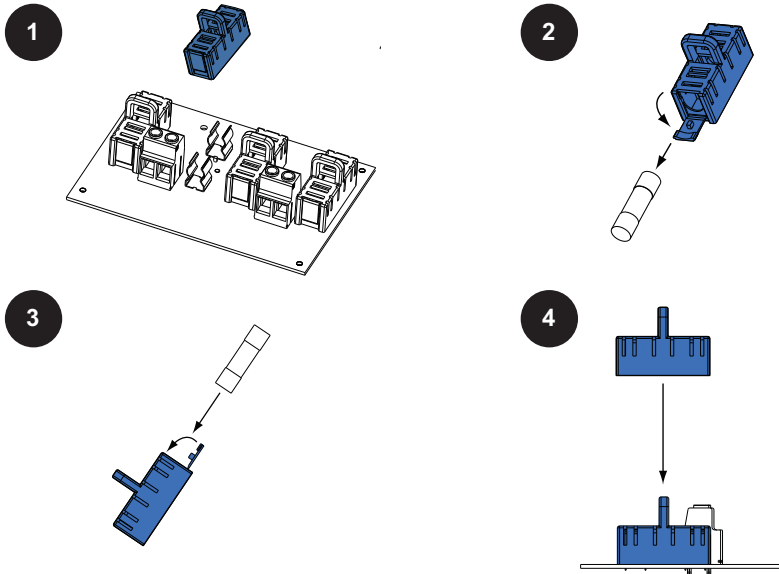
Ensure no live voltages are present on PV input and AC output circuits, and verify that the DC disconnect, AC disconnect, and dedicated AC branch circuit breaker are in the "OFF" position, before inverter installation.

Assurez-vous qu'aucune tension directe n'est présente sur les circuits photovoltaïques d'entrée et de sortie du CA, vérifiez que le CC et le CA sont déconnectés, et que le disjoncteur de dérivation dédié est sur position "OFF", avant de procéder à l'installation de l'onduleur.



PV solar arrays produce hazardous voltages and currents when exposed to light which can create an electrical shock hazard. Using dark opaque sheets, cover the PV solar array before wiring or connecting cable terminations.

Les panneaux solaires photovoltaïques produisent tensions et courants dangereux lorsqu'ils sont exposés à la lumière et constituent un danger de choc électrique. Couvrez le panneau solaire photovoltaïque à l'aide de morceaux de tissu opaques et foncés avant tout câblage ou connexion des terminaisons de câble.



**Figure 31: String fuse replacement procedure**

Note: Refer to Figure 31 for String Fuse Locations.

1. Gripping only the plastic tab on top of the fuse extractor, pull straight upwards without touching the fuse's metal end caps or fuse-holder clips on printed wiring board.
2. Away from open wiring box compartment, open the fuse extractor door and tilt fuse extractor downward with a hand underneath to catch fuse as it slides out of fuse extractor.
3. Next place the replacement fuse into fuse extractor and tilt upward to keep fuse from dropping out. Close the fuse extractor door.
4. With fuse/fuse extractor parallel to empty fuse position, lower fuse extractor while aligning fuse caps with open fuse clips. Then push downward until the fuse snaps into the clips.

Follow the same procedure for replacing string fuses.

## 4.8.6 Inverter AC output wire connections



- Read all of the instructions, cautions, and warnings for the Delta SOLIVIA Inverter, associated PV array documentation.

Lisez toutes les instructions, rubriques Prudence et Avertissement de l'onduleur Delta SOLIVIA, ainsi que la documentation sur le panneau photovoltaïque associé.

- Installation and commissioning must be performed by a licensed electrician in accordance with local, state, and National Electrical Code ANSI/NFPA 70 requirements.

L'installation et la mise en service doivent être effectuées par un électricien autorisé conformément aux exigences locales et nationales ainsi qu'au National Electrical Code ANSI/NFPA 70.

- Ensure no live voltages are present on PV input and AC output circuits, and verify that the DC disconnect, AC disconnect, and dedicated AC branch circuit breaker are in the "OFF" position, before inverter installation.

Assurez-vous qu'aucune tension directe n'est présente sur les circuits photovoltaïques d'entrée et de sortie du CA, vérifiez que le CC et le CA sont déconnectés, et que le disjoncteur de dérivation dédié est sur position "OFF", avant de procéder à l'installation de l'onduleur.

- Verify that dedicated 2-pole 240 Vac / 208 Vac circuit breaker in the building electrical service panel is turned-off.

Vérifiez que le disjoncteur à 2 circuits de 240 Vca / 208 Vca du tableau d'alimentation électrique du bâtiment est mis hors tension.



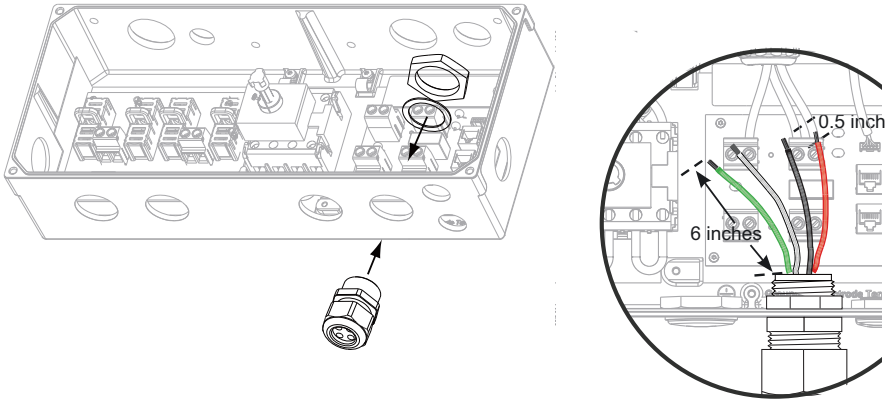
All screw terminals accept solid or stranded copper 14 – 6 AWG wire only. A 3.5 mm flat blade screw driver is recommended for tightening screw terminals to a 10.5 in-lbs (1.2 Nm) torque.

Toutes les bornes à vis n'acceptent que les fils de cuivre rigides ou souples de 14 – 6 AWG. Il sera recommandé d'utiliser un tournevis plat de 3,5 mm pour serrer les bornes à vis à un couple de 1,2 Nm (10,5 in-lbs).



The AC output (neutral) is not bonded to ground in the inverter.

La sortie de courant alternatif (neutre) n'est pas lié à la masse de l'onduleur.



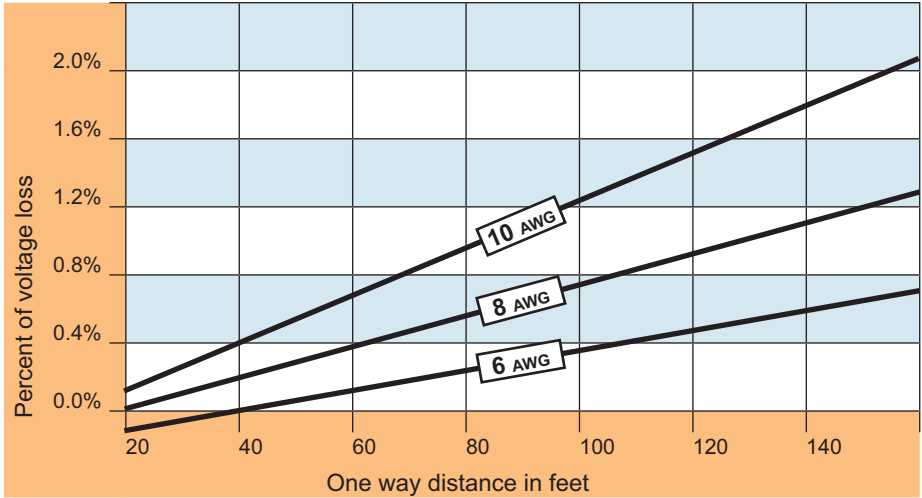
**Figure 32: Conduit installation and AC wiring routing**

Conduit fittings need to be water tight with either NEMA 4, 4X, 6, or 6X rated, and insulated type preferred.

Once conduit and fittings are installed, route wiring thru conduit and fitting and allowing a 6 inch strain relief loop within the wiring box compartment.

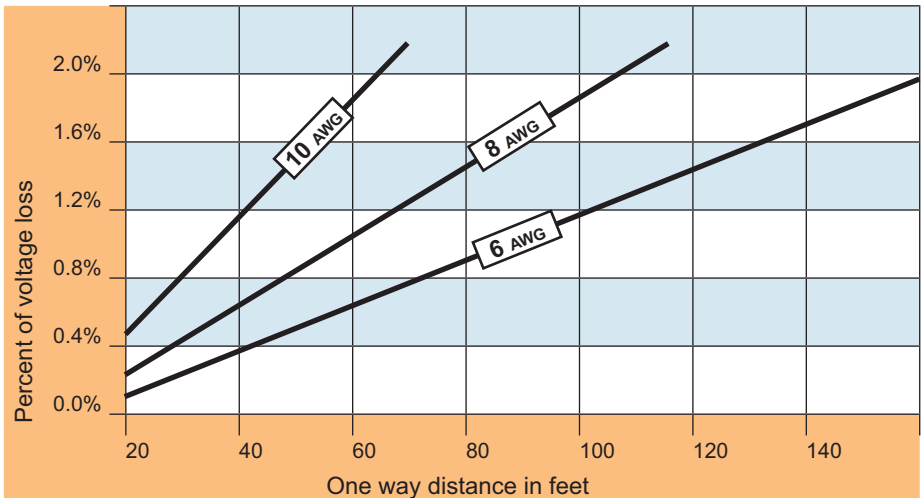
Potential AC voltage loss in AC wires is possible to determine for a given wire cross section and wire length. Pages 59 and 60 contain diagrams for each SOLIVIA solar inverter model to help determine the best wire size for your particular installation. Delta recommends you select a wire size and length to ensure a maximum voltage loss between 1 - 2 %. Please note that the diagrams only offer approximate voltage loss and more precise voltage loss should be calculated by a licensed electrician in accordance with local, state, and National Electrical Code ANSI/NFPA 70 requirements.

Percentage of voltage loss with 208 V AC and 240 V AC service. The load used in the calculation is the maximum continuous AC current of the inverter. The maximum AC current of 3.8 TL model and 3.0 TL model is similar.

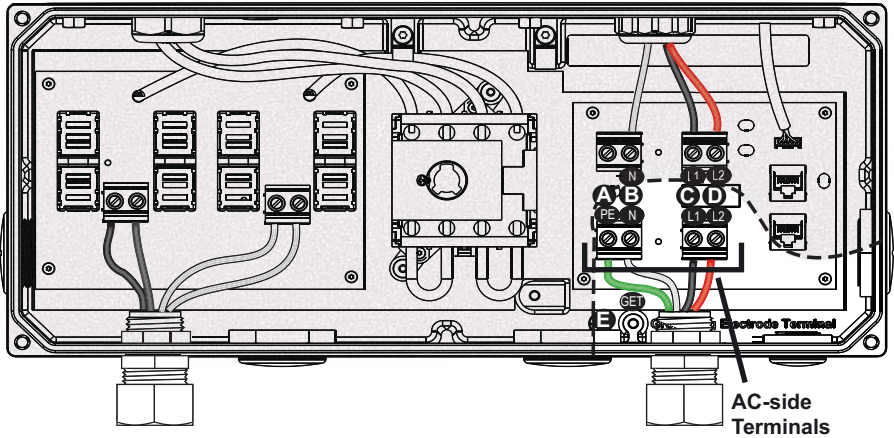


**Figure 33: SOLIVIA 3.0 / 3.8 TL-AC voltage loss in different wire sizes and lengths**

Percentage of voltage loss with 208 V AC and 240 V AC service. The load used in the calculation is the maximum continuous AC current of the inverter.



**Figure 34: SOLIVIA 5.2 / 6.6 / 7.6 TL- AC voltage loss in different wire sizes and lengths**



- A** PE Terminal (Grid Ground)
- B** N Terminal
- C** L1 Terminal
- D** L2 Terminal
- E** GET (Grounding Electrode Terminal)

**Figure 35: Wiring box AC assembly – terminal labeling**



Stranded copper wire should be checked so that all strands go into the terminal opening.

Il conviendra d'inspecter le fil de cuivre multi-filaire afin de s'assurer que tous ses brins sont insérés dans l'alésage de la borne.



AC disconnect may be required by your local AHJ. Please check local regulations to determine if the AC disconnect is required for your installation.

Une déconnexion du CA peut être requise par votre AHJ local. Veuillez consulter les règlements locaux afin de déterminer si la déconnexion du CA est requise pour votre installation.

1. Mount the AC disconnect (if required by local AHJ) close enough to the inverter.
2. Install conduit fitting and conduit into the wiring box compartment from AC disconnect or utility service panel.
3. Thread the inverter's AC output wires through cup piece of conduit and loosely fit the conduit into the inverter's open conduit fitting and the DC disconnect or junction box conduit fitting.
4. Route AC wiring through conduit and verify that the exposed wires are at least 6 inches in length to provide adequate strain relief and wire end strip length required. Secure the conduit into both fittings then tighten conduit fittings to manufacturer's recommended torque.

5. Terminate inverter's AC output wires inside the AC disconnect or junction box.
  - Connect the AC equipment GND wire to the PE screw terminal (A).
  - Connect the "WHITE" Neutral wire to the "N" screw terminal (B).
  - Connect "BLACK" L1 wire to the "L1" terminal (C)
  - Connect "RED" L2 wire to the "L2" terminal (D)
  - Use a 3.5 mm flat blade screwdriver tighten the screw terminal to 10.5 in-lbs (1.2 Nm) of torque for all above connections.



Stranded copper wire should be checked so that all strands go into the terminal opening.

Il conviendra d'inspecter le fil de cuivre multi-filaire afin de s'assurer que tous ses brins sont insérés dans l'alésage de la borne.



If the grid type with Neutral connection is selected, please double check whether the Neutral wire is connected reliably. The unsuccessful Neutral wire connection will make the unit fail to feed in power to the grid because of the wrong phase voltage detection.

Si un réseau électrique avec connexion de neutre est choisie, veuillez vérifier attentivement si le conducteur neutre est connecté de manière fiable. Une connexion échouée du conducteur neutre causera le manque d'énergie de l'appareil à cause de la détection de tention en mauvais phase.

#### 4.8.7 Inverter RS485 communication connections



Read all of these instructions, cautions, and warnings for the Delta SOLIVIA inverter and associated PV array documentation.

Lisez toutes les instructions, rubriques Prudence et Avertissement de l'onduleur Delta SOLIVIA, ainsi que la documentation sur le panneau photovoltaïque associé.



## Interface connection RS485 (EIA485)

The Delta SOLIVIA inverters offer an EIA RS485 communication interface which can address up to 31 daisy chained inverters. For optimal performance, all unused interface connections must always be terminated by placing the termination jumper in the "on" position.

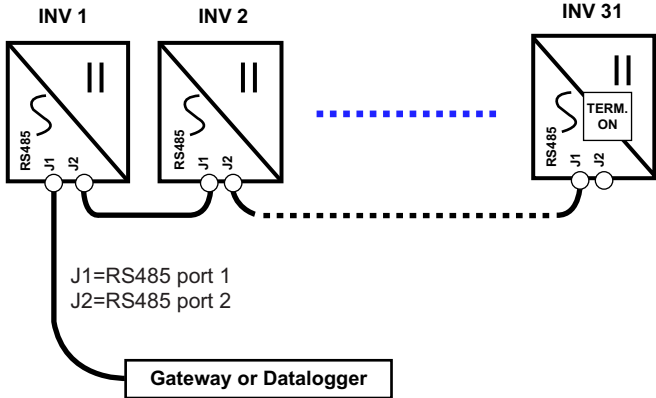


Figure 36: Inverter RS485 system diagram

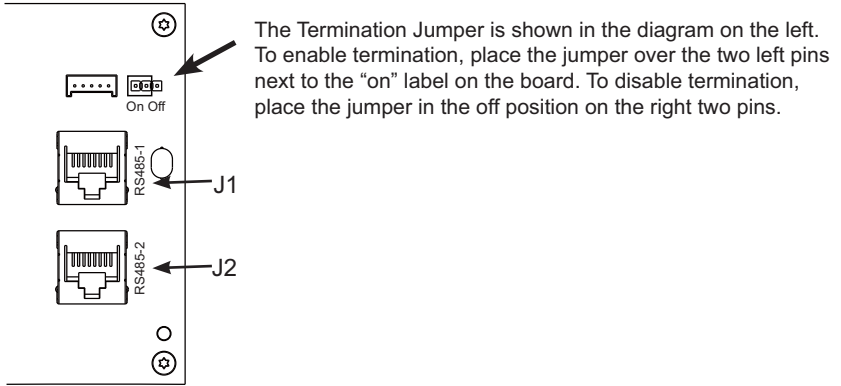


Figure 37: RS485 Termination Jumper

## RS485 (EIA485) connector pin-out

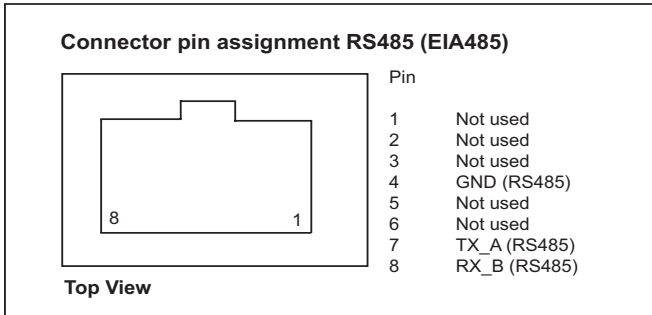


Figure 38: RS485 (EIA485) connector pin-out

RS485 data format	
Baud Rate	Programmable, 2400/4800/9600/19200/38400, default = 19200
Data Bit	8
Stop Bit	1
Parity	N/A

Table 4: RS485 data format

## 5 Commissioning the PV system



Read all of these instructions, cautions, and warnings for the Delta SOLIVIA inverter and associated PV array documentation.

Lisez toutes les instructions, rubriques Prudence et Avertissement de l'onduleur Delta SOLIVIA, ainsi que la documentation sur le panneau photovoltaïque associé.



Installation and commissioning must be performed by a licensed electrician in accordance with local, state, and National Electrical Code ANSI/NFPA 70 requirements.

L'installation et la mise en service doivent être effectuées par un électricien autorisé conformément aux exigences locales et nationales ainsi qu'au National Electrical Code ANSI/NFPA 70.



Verify that the dedicated 2-pole 240 Vac / 208 Vac circuit breaker in the building electrical service panel is turned-off.

Vérifiez que le disjoncteur à 2 circuits de 240 Vca / 208 Vca du tableau d'alimentation électrique du bâtiment est mis hors tension.



Disconnect in the “OFF” position, verify the PV input polarity once more simply by carefully using a 600 V, DC rated digital volt meter and probing the positive (+) and negative (-) PV array connections.

Débranchez l'appareil lorsqu'il est éteint (« OFF ») puis vérifiez à nouveau la polarité de l'entrée PV en utilisant simplement avec précaution un voltmètre numérique de valeur nominale de 600 Vcc et en prélevant les mesures au niveau des connexions positive (+) et négative (-) du groupe solaire PV.

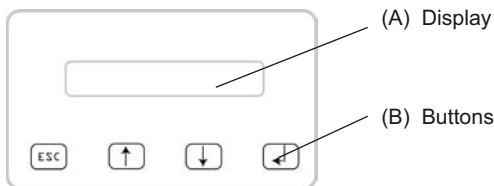
## 5.1 Status LEDs

Label	Designation	Color
<i>OPERATION</i>	Operation	Green
<i>EARTH FAULT</i>	Earth Fault	Red
<i>FAILURE</i>	Failure	Yellow

Information on the LED messages is provided in “8. Diagnosis and maintenance”.

## 5.2 Display and buttons

### 5.2.1 Components



### 5.2.2 Display layout

```
Format
-----
->Date:   DD.MM.YYYY
Time:    12h
```





The display has 4 rows of 20 characters each.

The first row contains the name of the currently displayed menu.

The second to fourth rows show the menu elements.

A small arrow in the third row shows the currently selected menu item.

### 5.2.3 Buttons

Symbol	Use
	<ul style="list-style-type: none"><li>• Exit the current menu</li><li>• Cancel the setting of a value</li></ul>
	<ul style="list-style-type: none"><li>• Move upwards in a menu</li><li>• Set a value (increase the value)</li></ul>
	<ul style="list-style-type: none"><li>• Move downwards in a menu</li><li>• Set a value (decrease the value)</li></ul>
	<ul style="list-style-type: none"><li>• Select a menu entry</li><li>• Open a configurable value for editing</li><li>• Finish editing (adopt the set value)</li></ul>

### 5.2.4 General menu structure

The menus have up to three levels:

[Main menu]

...

#### 400 Production info

##### 410 Current data

##### 411 Current overview

##### 412 Current data AC

...

##### 420 Day statistics

##### 430 Week statistics

...

#### 500 User settings

Most menu names consist of a three-digit number and a menu title.

See "13.3 Overview of menu structure" for an overview of the complete menu structure.

### 5.3 Inverter turn-on procedure

1. Turn on the DC disconnect (turn to "ON" position).
2. Check for inverter initialization; all 3 LED indicators are illuminated.
3. Turn on the dedicated 2-pole 240 Vac / 208 Vac circuit breaker in the building electrical service panel (put in closed position).
4. If there is AC disconnect, turn on the AC disconnect.
5. Refer to section 5 for setup process that needs to be completed before the inverter can begin feeding power to the grid.

## 5.4 Inverter turn-off procedure

1. If there is AC disconnect, turn off the AC disconnect.
2. Turn off the dedicated 2-pole 240 Vac / 208 Vac circuit breaker in the building electrical service panel (put in open position).
3. Turn off the DC disconnect (turn to "OFF" position).

## 5.5 Standard initial commissioning

### 5.5.1 Brief overview of the commissioning steps

- Select the grid
- Set up the RS485 communication
- Set up the AFCI setting

### 5.5.2 Detailed description of the commissioning steps


1. Check all connections and cables for damage and correct seating. Correct the installation if necessary.
2. Switch on the DC disconnect.  
→ The startup process of the solar power inverter begins.

After the startup process and the automatic self-test, the initial commissioning procedure of the solar power inverter starts and the **Install settings** menu is displayed.

3. Select a grid.

```
Grid Selection
-----
->Grid:      US 208 D
Continue
```

Grids available for standard commissioning			
Display text	Description	Display text	Description
US 208 D	US 208 DELTA.	HECO 208 D	HECO 208 DELTA.
US 208 WYE	US 208V/120V WYE	HECO 208 WYE	HECO 208V/120V WYE
US 240 D	US 240 DELTA	HECO 240 D	HECO 240 DELTA
US 240 STING	US 240/120 STING	HECO 240 STING	HECO 240/120 STING
US 240 SPLIT	US 240/120 SPLIT	HECO 240 SPLIT	HECO 240/120 SPLIT

4. Select **Continue** and press the  button.

```
Grid Selection
Grid:      US 208 D
->Continue
-----
```

→ The **RS485** menu is displayed

5. Set the RS485 ID and the baud rate.

```
RS485
-----
->ID:      1
Baud Rate: 19200
```

### Configurable parameters

Display text	Designation	Description
ID	RS485 ID	1 .. 255
Baud rate	Baud rate	2400   4800   9600   19200   38400, default is 19200




Connecting multiple solar power inverters via RS485.

- If multiple solar power inverters are to be connected via RS485, select a different ID for each inverter. This ID will also be used later to identify each solar power inverter when loading settings or transferring data.

Connexion de plusieurs onduleurs solaires via RS485.

- Si plusieurs onduleurs solaires doivent être connectés via RS485, sélectionnez un ID différent pour chaque onduleur. Cet ID sera utilisé plus tard pour identifier chaque onduleur solaire lors du chargement des paramètres ou du transfert des données.

6. Select **Continue** and press the  button.


```
RS485
Baud Rate: 19200
->Continue
-----
```

→ The last menu is displayed

7 Set the arc function

```

AFCI Setting
-----
->Mode:      disabled
Continue
    
```



8 Press the  button to finish commissioning.


```


ENTER
to confirm
ESC
to reselection
    
```


Commissioning is now finished.


### 5.6 Setting values

You can set parameters in several menus. The   buttons are used to change parameter values.

The  button increases the value of the parameter.









The  button decreases the value of the parameter.

























The  button can be used to cancel the setting, and the original value is then displayed once more.

Pressing the  button causes the new parameter value to be adopted.

The example on the next page illustrates the procedure for changing the value of a parameter. This procedure is the same for all configurable parameters.

*Example: Setting the date*

Buttons	Action	Result
 	1. Press the   buttons in the main menu to select the <b>Install settings</b> menu.	<pre> SOLIVIA ### ----- -&gt;Install settings Options                 </pre>
	2. ..Press the  button to open the <b>100 Install settings</b> (install settings) menu.	<pre> 100 Install settings ----- -&gt;Date and time Display settings                 </pre>
	3. ..Press the  button to open the <b>110 Date and time</b> menu.	<pre> 110 Date and time ----- -&gt;Date:      18/06/2013 Time:      13:10:20pm                 </pre>

Buttons	Action	Result
 	4. Use the   buttons to select <b>Date</b> menu item.	110 Date and time ----- ->Date: 18/06/2013 Time: 13:10:20pm
	5. ..Press the  button to begin making the setting.  → The digits for the first value (in this case the month) flash.	110 Date and time ----- ->Date: 18 06/2013 Time: 13:10:20pm
 	6. Use the   buttons to set the month.	110 Date and time ----- ->Date: 18/07/2013 Time: 13:10:20pm
	7. ..Press the  button to adopt the new value..  → The digits for the second value (in this case the day) flash.	110 Date and time ----- ->Date: 18/07/2013 Time: 13:10:20pm
 	8. Use the   buttons to set the day.	110 Date and time ----- ->Date: 15/07/2013 Time: 13:10:20pm
	9. ..Press the  button to adopt the new value..  → The digits for the last value (in this case the year) flash.	110 Date and time ----- ->Date: 15/07/2013 Time: 13:10:20pm
 	10. Use the   buttons to set the year.	110 Date and time ----- ->Date: 15/07/2014 Time: 13:10:20pm
	11. ..Press the  button to adopt the new value..  √ The value is adopted and the editing mode is exited.	110 Date and time ----- ->Date: 15/07/2014 Time: 13:10:20pm



## 6 Production information



All production information is provided for orientation purposes only. The measuring devices and meters provided by the electricity supply company are the authoritative source of information for invoicing.

Toutes les informations de production ne sont fournis qu'à titre d'orientation. Les appareils de mesure et les compteurs fournis par la société de distribution d'électricité constituent la source officielle de la facturation.

### 6.1 Overview

The 400 Production info menu contains current data and statistics. The information is write-protected and cannot be edited.

- Select the **Production info** menu item in the main menu.
  - The **400 Production info** menu is displayed.

```
400 Production Info
-----
->Current Data
Day Statistics
```

#### Structure of the 400 Production info menu

Sub-menu	Content	Description
410 Current data	Current data for power, AC, PV, insulation	"6.2 Current data"
420 Day statistics	Statistics for AC, PV and ISO	"6.3 Other statistics"
430 Week statistics		
440 Month statistics		
450 Year statistics		
460 Total statistics		
470 Feed-in settings	Settings for currency and revenue per kWh	"7.3 Grid feed-in settings"
480 Event journal	List of operating state messages	"8. Diagnosis and maintenance"
490 History	Statistics for the last seven days in which the solar power inverter was in operation.	"6.3 Other statistics"

## 6.2 Current data

### Relevant menu


The current production data is provided in the menu **410 Current data**.

### Access

- You access the menu by navigating to **Main menu > Production info > Current data**.
- The **410 Current data** menu is displayed.

```
410  Current data
-----
->Current overview
Current data AC
```

### Structure

Sub-menu	Contents and example display
411 Current overview	<p>Current power and energy generation of the current day. Current operating state (see “8. Diagnosis and maintenance”)</p> <pre>411 Current overview Now:                _W Day:                _Wh External events</pre> <p>If there are messages, the list of messages can be opened by pressing the  button. For a detailed description, see chapter “8. Diagnosis and maintenance”</p>
412 Current data AC	<p>Data for: voltage, current, frequency, active power P, reactive power Q</p> <pre>412 Current data AC ----- L1 Voltage:        _V L1 Current:        _._A</pre>
416 Current data PV	<p>Data for: voltage, current<sup>1)</sup></p> <pre>416 Current data PV PV1 Voltage:      ___V PV1 Current:      _._A</pre>

1) If inverter is with multi MPP trackers, data of voltage and current of each MPP tracker will be shown.

Sub-menu	Contents and example display
41A Date and time	Shows the current date and time.  Use the <b>110 Date and time</b> menu to set the values, see “7.2.1 Date and time”.  <pre>41A Date and time Date: 18/06/2013 Time: 10:20:30</pre>
41B Current isolat.	Data for: maximum and minimum insulation resistances  <pre>41B Current isolat. R iso+: _kΩ R iso-: _kΩ</pre>

### 6.3 Statistics

Menu
420 Day statistics
430 Week statistics
440 Month statistics
450 Year statistics
460 Total statistics
490 History

#### Example display

```
420 Day statistics
Day stat. AC
->Day stat. DC
Day stat. ISO
```

The statistics for day, week, month, year and total production time all offer the same type of data.

The **490 History** menu shows the statistics for the last seven days over which the solar power inverter was in operation.

490	History		
Day:	10.10.12		
->Day:	10.10.12		
Day:	10.10.12		

## Structure

Sub-menu	Contents
421 Day stat. AC	Statistics for: energy, runtime, revenue, I <sub>max</sub> (maximum current), P <sub>max</sub> (maximum active power), Q <sub>max</sub> (maximum reactive power), Q <sub>min</sub> (minimum reactive power)
431 Week stat. AC	
441 Month stat. AC	Information on configuring the revenue settings is provided in "7.3 Grid feed-in settings".
451 Year stat. AC	421 Day stat. AC
461 Total stat. AC	Energy: _____Wh Runtime: _____h Revenue: _____.__USD
	421 Day stat. AC
	L1 I <sub>max</sub> : _____.__A L1 P <sub>max</sub> : _____W L1 Q <sub>max</sub> : ind ____VAR
422 Day stat. DC	Data for: P <sub>max</sub> (maximum power), I <sub>max</sub> (maximum current), U <sub>max</sub> (maximum voltage)
432 Week stat. DC	422 Day stat. DC
442 Month stat. DC	PV1 P <sub>max</sub> : _____W PV1 I <sub>max</sub> : _____.__A
452 Year stat. DC	PV1 U <sub>max</sub> : _____V
462 Total stat. DC	
423 Day stat. ISO	Statistics for: maximum/minimum isolation resistances
433 Week stat. ISO	423 Day stat. ISO
443 Month stat. ISO	R ISO max: _____kΩ R ISO min: _____kΩ
453 Year stat. ISO	
463 Total stat. ISO	

Sub-menu	Contents
491 ... 497 Day ...	<p>Statistics for the last 7 days in which the solar power inverter was in operation.</p> <p>The statistics contain the same information as the menus <b>421</b>, <b>422</b> and <b>423</b>.</p> <pre> 491 Day      18.06.2013 Energy:     ---Wh Runtime:    -:--h Revenue:    --.---USD </pre>

## 6.4 Resetting statistics

### Description

All statistics can be reset (except for **410 Current data**). The procedure is always the same.




1. Navigate to **Production info > Feed-in settings > statistics**.

→ The **471 statistics** menu is displayed.


```

471 Statistics
>Reset day stat.
Reset week stat.
Reset month stat.

```

2. Use the   buttons to select the statistic you wish to delete (e.g., **Reset day stat.**) and press the  button.

→ A confirmation query is displayed.

3. Select the option **Yes** and press the  button to delete the statistic.

```

Reset day stat.
-----
No
->Yes

```

→ A confirmation message is displayed.

```

Reset day stat.

Successful
Press Enter

```

The statistic is deleted.

## 7 Settings

### 7.1 Overview

This chapter describes how to edit the configurable settings.

- Install settings (“7.2 Install settings”)
- Grid feed-in settings (“7.3 Grid feed-in settings”)
- Options settings (“7.4 Options settings”)
- Standard menu (“7.5 Standard menu”)

Information on operating the display is provided in “5.2 Display and buttons”.

### 7.2 Install settings

#### Configurable settings

- Date and time
- Date and time format
- Contrast
- Grid selection
- RS485 settings

#### 7.2.1 Date and time

##### Description

<b>Menu</b>	<b>110 Date and time</b>
<b>Menu access</b>	<b>Main menu &gt; Install settings &gt; Date and time</b>
<b>Example display</b>	<pre>110 Date and time ----- -&gt;Date: 18/06/2013 Time: 13:10:20pm</pre>

## Configurable parameters

Display text	Designation	Description
Date	Date	Freely configurable according to the selected date format.
Time	Time	Freely configurable according to the selected time format

### 7.2.2 Date and time format

#### Description

Menu	111 Format
Menu access	<b>Main menu &gt; Install settings &gt; Date and time &gt; Format</b>
Example display	<pre> 111 Format ----- -&gt;Date:   DD/MM/YYYY    Time:  13:10:20pm           </pre>

#### Configurable parameters

Display text	Designation	Description
Date	Date format	DD.MM.YYYY DD/MM/YYYY DD-MM-YYYY MM.DD.YYYY MM/DD/YYYY (default) MM-DD-YYYY YYYY.MM.DD YYYY/MM/DD YYYY-MM-DD
Time		12h   24h

### 7.2.3 Contrast

#### Description

Menu	120 Display settings
Menu access	Main menu > Install settings > Display settings
Example display	<pre>120 Display settings ----- -&gt;Contrast:           10 -----</pre>

#### Configurable parameters

Display text	Designation	Description
Contrast	Display Contrast	Display contrast level 1...10

### 7.2.4 Grid change



If the selected grid is changed, a completely new commissioning process is started, see "5. Commissioning the PV system".

Always first contact the Delta Support Team **before** changing the selected grid!

Si le réseau électrique sélectionnée est modifiée, un nouveau processus de mise en service est démarré, veuillez voir «5. Mise en service du système de PV» («5. Commissioning the PV system»).

Communiquez toujours avec l'équipe de soutien Delta **avant** de changer du réseau électrique sélectionnée!



A PIN is required each time when you wish to select a new grid. You can obtain a PIN from the Delta Support Team on request.

Un code PIN est nécessaire chaque fois quand vous souhaitez sélectionner une nouvelle réseau électrique. Vous pouvez obtenir un code PIN de l'équipe de Delta support sur demande.




You must provide a key in order to receive a PIN. You will find the key in the menu 132 Grid change.




1. To display the key, navigate to **Main menu > Install settings > Grid selection> Grid change**.

```
132 Grid change
Key:          #####
→PIN: -----
Grid:         US 208 D
```

The key consists of 11 numbers and/or letters.


2. The Delta Support Team will provide you with the four digit PIN.
3. When you have received the PIN, navigate to the menu **132 Grid change** and press the  button.

→ The first digit of the PIN flashes.

4. Use the   buttons to set the first digit and press the  button to proceed to the next digit.

→ After entering the full PIN, the word **Confirm** flashes.

```
132 Grid change
Key:          #####
PIN: 1234 →Confirm
Grid:         US 208 D
```

5. Press the  button to confirm the entered PIN.

→ The **Install settings** menu is displayed.

```
Grid Selection
-----
→Grid:         US 208 D
Continue
```

6. Change the grid type to current grid, see “5. Commissioning the PV system”.

## 7.2.5 RS485 settings

### Description

<b>Menu</b>	<b>111 Format</b>
Menu access	<b>Main menu &gt; Install settings &gt; RS485</b>
Example display	<pre>140      RS485 ----- -&gt;ID:                    1 Baudrate:                19200</pre>

### Configurable parameters

Display text	Designation	Description
ID	RS485 ID	1...255
Baudrate	Baud rate	2400   4800   9600   19200   38400, default is 19200



#### Connecting multiple solar inverters via RS485.

- ▶ Select a different ID for each solar power inverter.
- ▶ A termination resistor must be connected to the last solar power inverter in the series (see "7.2.5 RS485 settings").

#### Connexion de plusieurs onduleurs solaires via RS485.

- ▶ Sélectionnez un ID différent pour chaque onduleur solaire.
- ▶ Une résistance de terminaison doit être connectée au dernier onduleur solaire de la série (voir «7.2.5 paramètres RS485»).

### 7.3 Grid feed-in settings

#### Description

<b>Menu</b>	<b>470 Feed-in settings</b>
Menu access	<b>Main menu &gt; Production info&gt; Feed-in settings</b>
Example display	<pre>470 Feed-in settings ----- -&gt;Currency:          USD    USD / kWh:       0.28</pre>

#### Configurable parameters

Display text	Designation	Description
Currency	Currency	Name of currency.
USD / kWh	USD/kWh	The amount (USD) per kWh is required for the revenue calculation.

### 7.4 Options settings

#### Configurable settings

- Shading
- AFCI setting
- AFCI self test
- Arc fault clear

#### 7.4.1 Shading

##### Description

The “Shading” option is an extended MPP tracker. When the option is switched on, the MPP tracker performs an additional search at regular intervals.

The MPP tracker then searches for the maximum power over a wider voltage range.

This option should be switched on if shadows regularly pass slowly over the PV modules in the course of a day. These types of moving shadows can be caused by chimneys or trees, for example. This option has a relatively small effect in the case of fast-moving shadows, e.g., from passing clouds.

The option is set depending on the size of the shading.

<b>Menu</b>	<b>210 Shading</b>
Menu access	<b>Main menu &gt; Options &gt; Shading</b>
Example display	<pre> 210      Shading ----- -&gt;Mode:      disabled ----- </pre>

### Configurable parameters

Display text	Designation	Description
Mode	Mode	Disabled Extended MPP tracking is disabled
		High High shading, time cycle: 0.5 hours
		Medium Medium shading, time cycle: 2 hours
		Low Low shading, time cycle: 4.5 hours

### 7.4.2 AFCI setting



If the AFCI setting is changed, a completely new commissioning process is started, see “5. Commissioning the PV system”.

Always first contact the Delta Support Team **before** changing the arc setting!

Si le réglage d'AFCI est modifiée, un nouveau processus de mise en service est démarré, veuillez voir «5. Mise en service du système de PV» («5. Commissioning the PV system»).

Communiquez toujours avec l'équipe de soutien Delta **avant** de changer du réglage d'arc!



A PIN is required each time when you wish to change the AFCI setting. You can obtain a PIN from the Delta Support Team on request.


Un code PIN est nécessaire chaque fois quand vous souhaitez changer le réglage AFCI. Vous pouvez obtenir un code PIN de l'équipe de Delta support sur demande.

You must provide a key in order to receive a PIN. You will find the key in the menu 230 AFCI Setting.




1. To display the key, navigate to **Main menu > Options > AFCI Setting**.

```
230 AFCI Setting
Key:      #####
->PIN:    -----
Mode:      enabled
```

The key consists of 11 numbers and/or letters.


2. The Delta Support Team will provide you with the four digit PIN.
3. When you have received the PIN, navigate to the menu **230 AFCI Setting** and press the  button.

→ The first digit of the PIN flashes.

4. Use the   buttons to set the first digit and press the  button to proceed to the next digit.

→ After entering the full PIN, the word **Confirm** flashes.

```
230 AFCI Setting
Key:      #####
->PIN:    1234->Confirm
Mode:      enabled
```

5. Press the  button to confirm the entered PIN.

→ The **AFCI Setting** menu is displayed. You can enable or disable the arc detection function.

```
    AFCI Setting
-----
->Mode:      disabled
Continue
```

6. Start the commissioning of the solar power inverter, see “5. Commissioning the PV system”.

### 7.4.3 AFCI self test

#### Description

The “AFCI Self Test” is a manual test function. When “enable” it, a self test of arc detection function will be carried out. If the internal circuit is OK, the inverter will show “AFCI Test Pass!” on display and shut down once test is PASS. And inverter will start up again after the self test.

1. To display the arc self test, navigate to **Main menu > Options > AFCI Self Test**.

```
240 AFCI Self Test
-----
->Mode:      disabled
Normal Operation
```

2. To enable the AFCI self test, change the mode from “disabled” to “enabled”. When the test passes, the mode will change back to “disabled”. The inverter will be shut down.

```
240 AFCI Self Test
-----
->Mode:      disabled
AFCI Test Pass!
```

3. The inverter will restart up. The operation mode will shown “normal operation” again.

#### 7.4.4 Arc fault clear

##### Description


When an arc fault occurs, the inverter will shut down and “Arc Fault Detected!” will be displayed. The inverter will keep in off until the arc fault is cleared manually.

1. Check the operation mode of the inverter, navigate to **Main menu > Production info > Current data > Current overview**. If an arr fault occurs “Arc Fault Detected!” will be displayed.

```
411 Current overview
Now:           _W
Day:           _Wh
Arc Fault Detected!
```

2. To clear the arc fault status, navigate to **Main menu > Options > Clear Arc Fault**

```
Clear Arc Fault
-----
->No
Yes
```

3. Select “Yes” and press the  button.

```
Clear Arc Fault
Successful
Press Enter
```

4. Press the  button. The display page will go back. The inverter will start up.

## 7.5 Standard menu

### Description

A standard menu can be defined, which is automatically displayed when the display buttons are not used for a certain period of time. When the standard menu is displayed, pressing the **ESC** button displays the main menu.

The standard menu is set to 411 current data at the factory. This menu shows the current data and current operating messages.

The number must be a valid menu number.

See "13.3 Overview of menu structure" for an overview of all available menu numbers.

1. Press the **←** button to enter the menu number.  
→ The first digit flashes.
2. Enter the first digit of the menu number using the **↓** **↑** buttons.  
→ You can only set menu numbers that actually exist. The name of the associated menu is displayed in the fourth display row.
3. Once you have set the first digit, press the **←** button.  
→ The second digit flashes.
4. Enter the second and third digit in the same manner.
5. Press the **←** button  
→ The menu corresponding to the entered menunumber is displayed.

<b>Menu</b>	<b>800 Standard menu</b>
Menu access	<b>Main menu &gt; Standard menu</b>
Example display	<pre>800 Standard menu -&gt;Menu number: 411 411 Current overview</pre>

### Configurable parameters

Display text	Designation	Description
Menu number	Menu number	Any valid menu number.

## 8 Diagnosis and maintenance

### 8.1 Operating state

#### 8.1.1 Types of operating states

Operating state	Associated influencing factors	Grid feed-in
Normal operation	No factors are present that influence the production results.	Yes
Limited operation	Non-critical factors that can affect the production results but which are not failures (e.g., self-test).	Different
Warning	External events or internal failures are present that affect	Yes
Failure	the production results.	No
Insulation or grounding failure	Problems exist with insulation	No

See chapter "8.1.2 Factors influencing the operating state" for a description of the influencing factors.

Grid feed-in is always stopped when the solar power inverter enters the "Failure" operating state.

#### 8.1.2 Factors influencing the operating state

Different influencing factors are assigned to the individual operating states. These influencing factors are divided into the following categories.

##### Non-critical factors

Non-critical factors are (for example) the self-test or a DC voltage that is too low due to bad weather. Non-critical factors are therefore not failures.

##### Events

Events are usually caused outside the solar power inverter. Events are divided into **external events** (e.g., voltage or frequency errors) and **parameter changes** occurring via the buttons or the RS485 interface.

##### Internal failures

Internal failures are caused from within the solar power inverter and must be corrected with help of the Delta Support Team.

##### Insulation and grounding failures

Insulation and grounding failures are logged and displayed when this failure occurs.



### 8.1.3 Display of the current operating state

The current operating state is indicated via LEDs. A short message is also shown in the fourth line of the **411 Current overview** menu.

```
411 Current overview
Now:      _w
Day:      _wh
External events
```

The **411 Current overview menu** is automatically displayed when a new message arrives.

LED status	Message category	Display text in menu 411
Green Red Yellow	<ON> <OFF> <OFF>	Normal operation Normal operation
Green Red Yellow	<ON> <OFF> <OFF>	Limited operation e.g. Self-test
Green Red Yellow	<ON> <OFF> <Flash>	General warning messages For external events: External events For internal failures: Warning ### (3-digit number)
Green Red Yellow	<OFF> <OFF> <ON>	General failure messages For external events: External events For internal failures: Failure ### (3-digit number)
Green Red Yellow	<OFF> <ON> <OFF>	Insulation or grounding failure Insulation

The software defines which events trigger a warning and which events trigger a failure.

## 8.2 Event journal

### 8.2.1 Overview

<b>Menu</b>	<b>480 Event journal</b>
Menu access	<b>Main menu &gt; Production info&gt; Event journal</b>
Example display	<pre>480 Event journal ----- -&gt;External events Change events</pre>

The event journal contains the messages relating to the following events:

- Parameter changes  
Changes to all parameters influencing the energy production and thus also the revenue.
- External events
- Problems with the insulation and grounding

<b>Sub-menu</b>	<b>Description</b>
481 External events	A list of all external events.
482 Change events	A list of parameter changes made via the display or via RS485.

### 8.2.2 External events menu

#### Description

<b>Menu</b>	<b>481 External events</b>
Menu access	<b>Main menu &gt; Production info&gt; Event journal &gt; External events</b>
Example display	<pre>481 External events 18.06.2013 17:29:56 L1 Islanding Begin</pre>

The external event message has the following structure:

2nd line	Date and time when the external event occurred..
3rd line	Short description of the failure (see chapter "8.3 Fault-finding and correction")
4th line	Additional information, e.g., "Begin" for the occurrence of an event or "End" for the disappearance of an event.

## 8.2.3 Change events menu

### Description

The **482 Change events** menu contains a chronological list of all changes to parameters influencing the energy production and thus also the revenue.

Menu	482 Change events
Menu access	Main menu > Production info> Event journal > Change events
Example display	<pre>482 Change events 18.06.13 17:29:56 D Max. power:      100% Max. power:      90%</pre>

The parameter change entry has the following structure:

2nd line	Date and time when the external event occurred. Source of the change: D: Display E: External (RS485) S: System
3rd line	Name of the changed parameter + previous value
4th line	Name of the changed parameter + new value


## 8.3 Diagnosis and correction

### 8.3.1 External events / Insulation and grounding failures

The **411 Current overview** menu shows one of the following messages:

```
411 Current overview
Now:                -W
Day:                0Wh
External events
```

```
411 Current overview
Now:                -W
Day:                0Wh
Insulation
```

1. To receive a more exact description of the problem, press the  button in the **411 Current overview** menu.

→ The **External events** menu is displayed.

```
External events
PV1 ISO running fail
PV1 ISO startup fail
-----
```

The menu contains a list of all active messages relating to external events and insulation/grounding.

2. press the  button again.

→ The **480 Event journal** menu containing the detailed message text is displayed (see "8.2 Event journal").

```
480 Event journal
-----
->External events
Change events
```

3. Select the entry **External events** and press the  button again.

```
480 Event journal
-----
->External events
Change events
```

→ The **481 External events** menu is displayed.

```
481 External events
18.06.2013 17:29:56
L1 Islanding
Begin
```

Alternatively, you can also directly open the **481 External events** menu via the "Go to menu" function, see chapter "13.3.1 "Go to menu" function".

The following table shows the failure messages that can appear in the **481 External events** menu and provides fault-finding and correction suggestions.

LED Status		Display message	Message description	Fault correction
Green	<ON>	Warning ###	Internal failure ("Warning" + three-digit number)	▶ Please contact Delta Support.
Red	<OFF>			
Yellow	<Flash>			
Green	<OFF>	Failure ###	Internal failure ("Failure" + three-digit number)	▶ Please contact Delta Support.
Red	<OFF>			
Yellow	<ON>			
Green	<OFF>	L1 Voltage failure	AC overvoltage or undervoltage on phase L.	▶ Check the grid voltage shown on the display (menu <b>412 Current data AC</b> ). ▶ If no voltage is present, check the circuit breaker.
Red	<OFF>			
Yellow	<ON>			
Green	<OFF>	L1 Frequency error	AC high frequency or low frequency on phase L.	▶ Check the grid frequency shown on the display (menu <b>412 Current data AC</b> ). ▶ If no voltage is present, check the automatic circuit breaker.
Red	<OFF>			
Yellow	<ON>			
Green	<OFF>	L1 Islanding	Frequency shift failure on phase L.	▶ Ask your electricity supply company about the actual state of the grid. ▶ Check the installation. ▶ Restart the solar power inverter. Contain your maintenance technician if the failure persists.
Red	<OFF>			
Yellow	<ON>			
Green	<OFF>	PV Power too low	The solar power is too low.	Insufficient solar irradiation (dawn/dusk).. ▶ Check the PV cell voltage shown on the display (menu <b>416 Current data PV</b> ).
Red	<OFF>			
Yellow	<ON>			
Green	<OFF>	PV1 ISO startup fail	The startup insulation is too low.	▶ Check the insulation resistance at the DC side of the PV modules.
Red	<ON>			
Yellow	<OFF>			
Green	<OFF>	PV1 ISO running fail	Residual current excess the safety standard.	▶ Check the insulation resistance at the DC side of the PV modules.
Red	<ON>			
Yellow	<OFF>			

### 8.3.2 Internal failures

In the case of an internal failure, the message "Warning XXX" or "Failure XXX" is displayed in the **411 Current overview** menu. XXX stands for a 3-digit failure number.

```

411 Current data
L1                _W
Day:              _Wh
Warning 123
  
```

```

411 Current data
L1                _W
Day:              _Wh
Failure 351
  
```

In the case of internal failures, always contact the Delta Support Team (see address list on the rear cover of this manual).

### 8.3.3 Other LED and display messages

LED Status		Display message	Message description	Fault correction
Green	<Flash>	PV1 Voltage too low	The PV1 voltage is too low.	
Red	<OFF>		There is insufficient solar irradiation.	
Yellow	<OFF>		<ul style="list-style-type: none"> <li>▶ Check the PV cell voltage shown on the display (menu <b>416 Current data PV</b>).</li> </ul>	
Green	<ON>	L1 Power reduction	Power reduction active for L1.	
Red	<OFF>	PV1 PW limit to Pn	Power limiting active for PV1.	
Yellow	<OFF>	PV1 Temp derating	Temperature derating active for PV1. Reduced electricity production.  The internal temperature of the solar power inverter lies between +45 and +70 °C.  <ul style="list-style-type: none"> <li>▶ Check the ventilation of the solar power inverter.</li> <li>▶ Prevent direct sunlight from reaching the solar power inverter.</li> </ul>	

## 8.4 Displaying grid settings

### Description

The actual grid settings can be displayed using the **131 View grid setup** menu. The contents of this menu are write-protected.

Menu	131 View grid setup
Menu access	Main menu > Install settings >Grid selection> View grid setup
Example display	<pre>131 View grid setup ----- -&gt;Grid:      US 208 D Fnom:      --.--Hz</pre>

If a power limit was set when the solar power inverter was commissioned, then the following message is displayed before the menu opens:

```
The maximun power
of that inverter
has been limited to
##.##kW
```

## 8.5 Internal log

### Description

The internal log contains information on the internal failures that have occurred.

Menu	620 Internal log
Menu access	Main menu > Diagnostic&Alarm > Internal log
Example display	<pre>620 Internal log 12.04.12 7:39:25 126 127</pre>

Parameter change entries have the following structure

3rd Line	Date and time when the external event occurred.
4th Line	Number(s) of the internal failure(s)

## 8.6 Maintenance



### **Danger of death from hazardous voltage.**

Hazardous voltage is applied to the solar power inverter during operation. Hazardous voltage is still present 5 minutes after all power sources have been disconnected.

► Never open the solar power inverter. The solar power inverter contains no components that are to be maintained or repaired by the operator or installer. Opening the cover will void the warranty.

### **Risque de mort par une tension dangereuse.**

La tension dangereuse est appliquée à l'onduleur solaire pendant le fonctionnement. Une tension dangereuse est toujours présente 5 minutes après que toutes les sources d'alimentation ont été débranchées.

► Ne jamais ouvrir le onduleur solaire. L'onduleur solaire ne contient pas de composants qui doivent être entretenus ou réparés par l'opérateur ou l'installateur. Ouverture du couvercle annule la garantie.

Ensure that the solar power inverter is not covered during operation.

Regularly clean the solar power inverter to prevent soiling of the housing.

## 9 Repair



### **Danger of death from hazardous voltage.**

Hazardous voltage is applied to the solar power inverter during operation. Hazardous voltage is still present 5 minutes after all power sources have been disconnected.

► Never open the solar power inverter. The solar power inverter contains no components that are to be maintained or repaired by the operator or installer. Opening the cover will void the warranty.

### **Risque de mort par une tension dangereuse.**

La tension dangereuse est appliquée à l'onduleur solaire pendant le fonctionnement. Une tension dangereuse est toujours présente 5 minutes après que toutes les sources d'alimentation ont été débranchées.

► Ne jamais ouvrir le onduleur solaire. L'onduleur solaire ne contient pas de composants qui doivent être entretenus ou réparés par l'opérateur ou l'installateur. Ouverture du couvercle annule la garantie.



The solar power inverter contains no components that are to be maintained by the operator or installer.

L'onduleur solaire ne contient pas de composants qui doivent être mis à jour par l'opérateur ou l'installateur.



## 10 Decommissioning, transport, storage, disposal



### **Danger of death or severe injuries from dangerous voltage**

► Disconnect the solar inverter from the grid before removing or inserting the AC connector.

### **Danger de mort ou de blessures graves par une tension dangereuse**

► Déconnecter l'onduleur solaire du réseau électrique avant de retirer ou d'insérer le connecteur AC.



### **Danger of death or severe injuries from dangerous voltage**

Dangerous voltages can be present at the DC connections of the solar power inverter.

► Never disconnect the PV modules when the solar power inverter is under load. First switch off the grid connection so that the solar power inverter cannot feed energy into the grid. Then open the DC disconnecter.

► Secure the DC connections against being touched.

### **Danger de mort ou de blessures graves par une tension dangereuse**

Des tensions dangereuses peuvent être présentes sur les connexions CC de l'onduleur solaire.

► Ne jamais déconnecter les modules PV lorsque l'onduleur solaire est en cours de charge. D'abord désactiver la connexion au réseau électrique de sorte que l'onduleur solaire ne peut pas fournir de l'énergie dans le réseau. Ensuite, déconnectez le sectionneur CC.

► Sécuriser les connexions CC contre être touché.



### **Danger of injury due to heavy weight**

The solar power inverter is heavy (see "11.2 Technical data"). Incorrect handling can lead to injuries.

► The solar power inverter must be lifted and carried by two people.

### **Risque de blessure en raison du poids lourd**

L'onduleur solaire est lourd (voir «11.2 Caractéristiques techniques»).

Une mauvaise manipulation peut entraîner des blessures.

► Il faut que l'onduleur solaire soit soulevé et déplacé par deux personnes.

## **10.1 Decommissioning**

1. Switch off the AC cable to be free of voltage.
2. Open the DC disconnecter.
3. Remove all cables from the solar power inverter.
4. Unscrew the solar power inverter from the wall bracket.
5. Lift the solar power inverter from the wall bracket.

## **10.2 Packaging**

Use the original packaging or packaging of the same quality.

## **10.3 Transport**

Always transport the solar power inverter in the original packaging or packaging of the same quality.

## **10.4 Storage**

Always store the solar power inverter in the original packaging or packaging of the same quality. Observe the specifications relating to storage conditions described in chapter "11.2 Technical data".

## **10.5 Dispose**

Dispose of the solar power inverter in a technically appropriate manner according to the legal requirements of your country.

# **11 Certificate and technical data**

## **11.1 Certificate**

Please check our web site at: <http://www.delta-americas.com/SolarInverters.aspx> for the most recent certificates.

## 11.2 Technical data

INPUT (DC)	SOLIVIA 3.0 TL	SOLIVIA 3.8 TL	SOLIVIA 5.2 TL	SOLIVIA 6.6 TL	SOLIVIA 7.6 TL
Max. recommended PV power	3600 W <sub>p</sub>	4560 W <sub>p</sub>	6240 W <sub>p</sub>	7920 W <sub>p</sub>	9120 W <sub>p</sub>
Max. system voltage	600 V				
Nominal voltage	380 V				
Operating voltage range	140 ~ 550 V (Power starts up at 150V)				
Full power MPPT range	200 ~ 500 V				
Max. input current <sup>1)</sup>	18 A	20 A	15 A per MPP tracker	18 A per MPP tracker	20 A per MPP tracker
Max. short circuit current	24 A	24 A	24 A per MPP tracker	24 A per MPP tracker	24 A per MPP tracker
Max. allowable imbalance power <sup>2)</sup>	-	-	1700W / 3800W	2100W / 4800W	2400W / 5600W
DC disconnect	Internal				
MPP tracker	1	1	2	2	2
MPP efficiency	99.8% (static) 99.5% (dynamic)				
Total input strings available	2	2	4	4	4
OUTPUT (AC)	SOLIVIA 3.0 TL	SOLIVIA 3.8 TL	SOLIVIA 5.2 TL	SOLIVIA 6.6 TL	SOLIVIA 7.6 TL
Nominal power	3000 W	3800 W	5200 W	6600 W	7600 W
Max. continuous output power <sup>3)</sup>	3000 W @ 208 V / 3000 W @ 240 V	3300 W @ 208 V / 3800 W @ 240 V	5200 W @ 208 V / 5200 W @ 240 V	6600 W @ 208 V / 6600 W @ 240 V	6600 W @ 208 V / 7600 W @ 240 V <sup>1)</sup>
Operating voltage range	183 ~ 228 V @ 208 V / 211 ~ 264 V @ 240 V				
Nominal current	14.4 A @ 208 V / 12.5 A @ 240 V	15.8 A @ 208 V / 15.8 A @ 240 V	25.0 A @ 208 V / 21.6 A @ 240 V	31.7 A @ 208 V / 27.5 A @ 240 V	31.7 A @ 208 V / 31.7 A @ 240 V
Max. continuous output current	15.0 A	16.0 A	27.5 A	32.0 A	32.0 A
Max. output over-current protection	28A		56A <sup>4)</sup>		
Nominal frequency	60 Hz				
Operating frequency range	59.3 ~ 60.5 Hz / 57.0 ~ 60.5 Hz @ HECO grid				
Night consumption	< 1W				
Total harmonic distortion @ nominal power	< 3%				
Power factor @ nominal power	> 0.99				

1) The inverter will work in power limit mode if the input current of PV is larger than the Max. input current.

2) Un-balance PV input allowed, maximum input power for each MPP tracker is limited with 70% rating power. And total input is limited with 100% rating power.

3) The maximum AC power value indicates the power an inverter might be able to deliver, but such a maximum AC power may not necessarily be achieved.

4) Max. output fault current and duration is 140Apk, 2ms duration@208V, 116.8Apk, 6.15ms duration@240V.

GENERAL SPECIFICATION	SOLIVIA 3.0 TL	SOLIVIA 3.8 TL	SOLIVIA 5.2 TL	SOLIVIA 6.6 TL	SOLIVIA 7.6 TL
Max. efficiency	98%				
CEC efficiency	97.5% @ 208V / 97.5% @ 240V				
Operating temperature range	-13 ~ 158 °F (-25 ~ 70 °C), no derating below 122°F (50°C)				
Storage temperature range	-40 ~ 185 °F (-40 ~ 85 °C)				
Humidity	0 ~ 100%				
Max. operating altitude	2000 m above sea level				

MECHANICAL DESIGN	SOLIVIA 3.0 TL	SOLIVIA 3.8 TL	SOLIVIA 5.2 TL	SOLIVIA 6.6 TL	SOLIVIA 7.6 TL
Size L x W x D inches (L x W x D mm)	17.5 x 15.8 x 8.5 (445 x 401 x 216)		26.8 x 15.8 x 8.5 (680 x 401 x 216)		
Weight	43.0 lbs. (19.5 kg)		65.0 lbs. (29.5 kg)		
Cooling	Convection				
AC connectors	Screw terminals in connection box				
DC connectors	2 pairs of screw terminals in connection box		4 pairs of screw terminals in connection box		
Communication interface	RS485				
Display	3 LEDs, 4-line LCD				
Enclosure material	Diecast aluminum				

STANDARDS / DIRECTIVES	SOLIVIA 3.0 TL	SOLIVIA 3.8 TL	SOLIVIA 5.2 TL	SOLIVIA 6.6 TL	SOLIVIA 7.6 TL
Electronics protection rating	NEMA 4, IEC 60068-2-11 (Salt mist corrosion protection)				
Safety	UL 1741, CSA 22.2 No. 107-01				
SW Approval	UL 1998				
Isolation Monitor Interrupt (IMI)	NEC 690.35, UL1741 CRD				
Anti-islanding protection	IEEE 1547, IEEE 1547.1				
EMC	FCC part 15 A & B, ICES-003				
AFCI	UL1699B (Type 1), NEC 690 2014				

WARRANTY	SOLIVIA 3.0 TL	SOLIVIA 3.8 TL	SOLIVIA 5.2 TL	SOLIVIA 6.6 TL	SOLIVIA 7.6 TL
Standard warranty	10 years				
Extended warranty	Additional 5 years (15 years total) or additional 10 years (20 years total)				

Utility interconnection voltage and frequency trip limits and trip times for all models:

Simulated utility source		Maximum time (sec) at 60Hz before cessation of current to the simulated utility
Voltage (V)	Frequency (Hz)	
< 50% V	Rated (60 Hz)	0.16
50% V ≤ V < 88% V	Rated (60 Hz)	2
110% V < V < 120% V	Rated (60 Hz)	1
120% V ≤ V	Rated (60 Hz)	0.16
Rated	f > 60.5	0.16
Rated	f < 59.3	0.16

Trip limit and trip time accuracy for all models:

Voltage:	±2 V (L-L)
Frequency:	±0.01Hz
Time:	1%, but not less than 120ms

If the HECO grid is selected, the SOLIVIA inverters comply with HECO Tariff Rule 14H as the following trip settings:

Frequency Trip Limit (Hz)	Clearing Time (s)
>60.5	0.16
57.0 to 60.5	Normal Operation
<57.0	0.16

The SOLIVIA inverters meet the TOV (transient over-voltage) standard required by Hawaiian Electric Companies. They have the ability to trip within a duration of 1 cycle (or 1/60th of a second) or less when it senses voltage above 120% of nominal voltage.

### 11.3 FCC compliance information

These devices, DELTA ELECTRONICS (SHANGHAI) CO.,LTD. string inverters, Model SOLIVIA 3.0 TL, SOLIVIA 3.8 TL, SOLIVIA 5.2 TL, SOLIVIA 6.6 TL and SOLIVIA 7.6 TL, comply with Part 15 of the FCC Rules. Operation is subject to the following conditions:

- (1) This device may not cause harmful interference, and
- (2) This device must accept any interference received, including interference that may cause undesired operation.

Note: This equipment has been tested and found to comply with the limits for a Class B digital device, pursuant to part 15 of the FCC Rules. These limits are designed to provide reasonable protection against harmful interference in a residential installation. This equipment generates, uses and can radiate radio frequency energy and, if not installed and used in accordance with the instructions, may cause harmful interference to radio communications. However, there is no guarantee that interference will not occur in a particular installation. If this equipment does cause harmful interference to radio or television reception, which can be determined by turning the equipment off and on, the user is encouraged to try to correct the interference by one or more of the following measures:

Reorient or relocate the receiving antenna

Increase the separation between the equipment and the receiver

Connect the equipment into an outlet on a circuit different from that to which the receiver is connected.

Consult the dealer or an experienced radio/TV technician for help.

The user is cautioned that changes or modifications not expressly approved by Delta Products Corporation could void the user's authority to operate this equipment.

Please Contact Delta Products Corporation for more information:

**Delta Products Corporation**

15700 Don Julian Road

City of Industry, CA 91745, U.S.A

<http://www.delta-americas.com/SolarInverters.aspx>

Support Email: [support.usa@solar-inverter.com](mailto:support.usa@solar-inverter.com)

Support Hotline: 1-877-442-4832

Monday to Friday from 8:30am to 5pm (apart from official Bank Holidays)

**11.4 Canada compliance information**

This Class B digital apparatus complies with Canadian ICES-003.

## 12 Warranty

The SOLIVIA 3.0 TL, 3.8 TL, 5.2 TL, 6.6 TL or 7.6 TL grid-tied inverter includes a standard 10-year warranty in effect from the time your inverter is commissioned. For all the SOLIVIA NA warranty terms and return procedures, please refer to our web site at <http://www.delta-americas.com/SolarInverters.aspx> for further information.

For assistance with warranty repairs or returns you may contact our North America support hotline at: 1-877-442-4832 or via email at [support.usa@solar-inverter.com](mailto:support.usa@solar-inverter.com).

## 13 Appendix

### 13.1 Overview of setting options

The following table contains an overview of all settings that can be made in the solar power inverter.

Function / Characteristic	Short description	Menu Manual chapter
<b>Options</b>		<b>200 Options</b> "7.4 Options settings"
Shading	For setting up the extended MPP tracking	<b>210 Shading</b> "7.4.1 Shading"
<b>Display settings</b>		
Date and time	For setting the date and time	<b>110 Date and time</b> "7.2.1 Date and time"
Date and time format	For setting the date and time formats	<b>111 Format</b> "7.2.2 Date and time formats"
contrast	For setting the contrast	<b>120 Display settings</b> "7.2.3 Contrast"
Standard menu	For selecting the display to be shown when no button has been pressed for a certain period of time.	<b>800 Standard menu</b> "7.5 Standard menu"
<b>Monitoring</b>		
RS485 settings	For setting the RS485 ID and the baud rate and for switching the termination resistor on and off	<b>150 RS485</b> "7.2.5 RS485 settings"
<b>Showing statistics</b>		
Showing statistics on the display	-	<b>400 Production info</b> "6. Production information"
<b>Feed-in settings</b>		
Currency, revenue per kWh	For setting the currency and the revenue per kWh	<b>471 Feed-in settings</b> "7.3 Grid feed-in settings"

## 13.2 Accessory

Gateway available for SOLIVIA 3.0 TL, SOLIVIA 3.8 TL, SOLIVIA 5.2 TL, SOLIVIA 6.6 TL and SOLIVIA 7.6 TL.

SOLIVIA Gateway	Delta part number
SOLIVIA GW WEB MONITOR GATEWAY M1 G2	EOE90010381

## 13.3 Overview of menu structure

### 13.3.1 "Go to menu" function



You can use the "Go to menu" function to directly navigate to a particular menu.

Vous pouvez utiliser la fonction «Aller au menu» («Go to menu») pour naviguer directement à un menu particulier.

1. To open the Go to menu function, press and hold the **ESC** button on the solar power inverter for at least 3 seconds.

→ **Go to menu** opens.

```
Go to menu
->Menu:      000
SOLIVIA ###
```

2. Press the **Enter** button to enter the menu number.  
→ The first digit flashes.
3. Enter the first digit of the menu number using the buttons. Press the **Down/Up** button when you are finished.  
→ The second digit flashes.
4. Enter the second and third digit in the same manner.
5. Press the **Enter** button.  
→ The menu corresponding to the entered menu number is displayed.

### 13.3.2 Install settings (100)

100 Install	Explanation
130 Grid selection	Display the grid settings, change the grid
140 RS485	Change RS485 settings



110 Date and time		Explanation
Date:	18/06/2013	Date
Time:	15:12:23	Time
111 Format		Date and time formats

111 Format		Explanation
Date:	DD/MM/YYYY	Date format
Time:	24h	Time format (12h or 24h)

120 Display settings		Explanation
Contrast:	10	Display contrast level 1...10

130 Grid selection		Explanation
131 View grid setup		Actual grid settings
132 Grid change		Set a different grid

140 RS485		Explanation
ID:	---	If multiple solar power inverters are connected via RS485, then each inverter must have a different ID. (1 ... 254)
Baudrate:		Baud rate (2400 / 4800 / 9600 / 19200 / 38400)

### 13.3.3 Shading (210)

Mode	Explanation
Disable	Monitoring is deactivated.
High	High shading, time cycle: 0.5 hours
Medium	Medium shading, time cycle: 2 hours
Low	Low shading, time cycle: 4.5 hours

210 Shading		Explanation
Mode	Disable	Disabled / High / Medium / Low

### 13.3.4 Production information (400)

<b>400 Production info</b>	<b>Explanation</b>
410 Current data	Current power and energy values. Messages on the current operating status.
420 Day statistics	Statistics for the current day
430 Week statistics	Statistics for the current calendar week
440 Month statistics	Statistics for the current calendar month
450 Year statistics	Statistics for the current calendar year
460 Total statistics	Statistics for the entire operating period
470 Feed-in settings	Settings for currency and revenue per kWh
480 Event journal	Messages of events
490 History	Power and energy value of latest 7 days

<b>410 Current data</b>	<b>Explanation</b>
411 Current overview	Current status
412 Current data AC	AC = AC side
416 Current data PV	PV = module side
41A Date and time	Date and time
41B Current isolat.	Isolation resistance value

<b>411 Current overview</b>	<b>Explanation</b>
Now:                                 200W	Current active power
Day:                                 2000Wh	Energy production current day
External Events	Current status messages

<b>412 Current data AC</b>	<b>Explanation</b>
L1 voltage:                         ---V	Voltage
L1 Current:                         -.-A	Phase current
L1 Freq.:                            ---HZ	Frequency
L1 P:                                 ---W	Active power
L1 Q:    ind                         ---Var	Reactive power

416 Current data PV		Explanation
PV1 Voltage:	---V	Voltage on the PV side
PV1 Current:	-.--A	Current on the PV side

41A Date and time		Explanation
Date:	18.06.2013	Current date
Time:	15:05:19	Current time

41B Current isolat.		Explanation
R iso:	----kΩ	Isolation resistance

420 Day statistics		Explanation
421 Day stat. AC		AC = AC side
422 Day stat. DC		DC = DC side
423 Day stat. ISO		ISO = Isolation
430 Week statistics		
440 Month statistics		
450 Year statistics		
460 Total statistics		
470 Feed-in settings		
480 Event journal		
490 History		

421 Day stat. AC		Explanation
Energy:	---Wh	Energy
Runtime:	-:--h	Runtime
Revenue:	-.--USD	Revenue
L1 I <sub>max</sub> :	-.--A	Maximum current
L1 P <sub>max</sub> :	---W	Maximum active power
L1 Q <sub>max</sub> :	---Var	Maximum reactive power
L1 Q <sub>min</sub> :	---Var	Minimum reactive power
<b>431 Week statistics AC</b>		
<b>441 Month statistics AC</b>		
<b>451 Year statistics AC</b>		
<b>461 Total statistics AC</b>		

422 Day statistics DC		Explanation
PV1 I <sub>max</sub> :	---A	Maximum current
PV1 U <sub>max</sub> :	---V	Maximum voltage
PV1 P <sub>max</sub> :	---W	Maximum power
<b>432 Week statistics DC</b>		
<b>442 Month statistics DC</b>		
<b>452 Year statistics DC</b>		
<b>462 Total statistics DC</b>		

423 Day statistics ISO		Explanation
R ISO max:	---kΩ	Maximum isolation resistance
R ISO min:	---kΩ	Minimum isolation resistance
<b>433 Week statistics ISO</b>		
<b>443 Month statistics ISO</b>		
<b>453 Year statistics ISO</b>		
<b>463 Total stat. ISO</b>		

470 Feed-in settings		Explanation
Currency	USD	Define the name of currency
USD / kWh:	#.##	Define the revenue per kWh

480 Event journal		Explanation
481 External events		Overview of all external events and insulation/grounding problems
482 Change events		Overview of all parameter changes

491 Day		Explanation
Energy:	---Wh	Energy
Runtime:	-:--h	Runtime
Revenue:	-.--USD	Revenue
L1 I <sub>max</sub> :	-.--A	Maximum current
L1 P <sub>max</sub> :	---W	Maximum active power
L1 Q <sub>max</sub> :	---Var	Maximum reactive power
L1 Q <sub>min</sub> :	---Var	Minimum reactive power
PV1 I <sub>max</sub> :	-.--A	Maximum current
PV1 U <sub>max</sub> :	---V	Maximum voltage
PV1 P <sub>max</sub> :	---W	Maximum power
R iso max:	---kΩ	Maximum isolation resistance
R iso min:	---kΩ	Minimum isolation resistance
492 Day		
493 Day		
494 Day		
495 Day		
496 Day		
497 Day		

### 13.3.5 Diagnostic and Alarm (600)

The reports that are displayed depend on the grid that has been set:

- Internal log (is always displayed)

600 Diagnostic&Alarm	Explanation
620 Internal log	Firmware update

### 13.3.6 Software version/inverter data (700)

700 Inverter info	Explanation
710 Software vers.	Version of the installed software
720 Inverter data	Production date and serial number

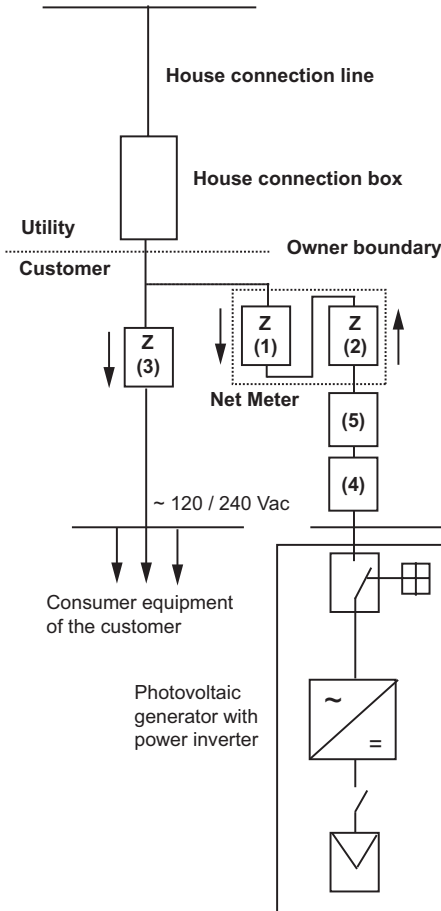
### 13.3.7 Standard menu (800)

800 Standard menu	Explanation
Menu number:	Number of the menu that is to be displayed as the standard menu.

13.4 Connection example

Individual in-plant generation system in parallel operation without isolated operation possibility, single-phase feed with anti-islanding protection, separate feed.

Low-voltage grid ~ 120 / 240 Vac



(4) AC Branch Protection

(5) AC Disconnect Switch  
(May not be required; check with local AHJ)

**Measurement unit**

- (1) Meter for power consumption
- (2) Meter for power feed-in with back stop in each case

Remark: A meter can also be employed which registers both energy directions separately.

(3) Meter for power take-off of the customer system

Electric circuit distributor

**Switching equipment**

Anti-islanding protection with voltage and frequency monitoring, as well as network impedance measurement

Short-circuit protection  
Overload protection

## 14 Glossary

### **AC**

Abbreviation for "Alternating Current".

### **AFCI**

Abbreviation for "Arc-Fault Circuit Interrupters".

### **AHJ**

Abbreviation for "Authority Having Jurisdiction".

### **Anti-islanding protection**

This is a unit for grid monitoring with assigned switching elements (anti-islanding protection) and is an automatic isolation point for small power generation systems (to 30 kWp).

### **Basic Insulation**

Insulation to provide basic protection against electric shock.

### **CEC**

Abbreviation for the California Energy Commission.

### **CEC Efficiency**

CEC Efficiency is the California Energy Commission Efficiency rating, a performance rating for modules and inverters based on the real environment that a system will be in.

### **CRC**

Abbreviation for cyclic redundancy check.

### **CSA**

Abbreviation for the Canadian Standards Association.

### **CT**

Abbreviation for current transformer.

### **DC**

Abbreviation for Direct Current.

### **DAC**

Digital to analog conversion.

### **EMC**

The Electro-Magnetic Compatibility (EMC) concerns the technical and legal basics of the mutual influencing of electrical devices through electromagnetic fields caused by them in electrical engineering.

### **FCC**

FCC is the abbreviation for Federal Communications Commission.

### **Galvanic isolation**

No conductive connection between two component parts.

### **GET**

Grounding Electro Terminal



**GND**

Ground

**IEEE**

The Institute of Electrical and Electronics Engineers or IEEE (read I-Triple-E) is an international non-profit, professional organization for the advancement of technology related to electricity.

**IMI**

Isolation Monitor Interrupter

**Initialization**

Under initialization (cf. English to initialize) is understood the part of the loading process of a program, in which the storage space required for the execution (e.g. variable, code, buffers ...) for the program is reserved and is filled with initial values.

**Isc**

Short Circuit Current

**Local utility company**

A local utility company is a company which generates electrical energy and distributes it over the public grid.

**MPP**

The Maximum Power Point is the point on the current-voltage (I-V) curve of a module, where the product of current and voltage has it's maximum value.

**NEC**

The National Electrical Code (NEC), or NFPA 70, is a United States standard for the safe installation of electrical wiring and equipment.

**Nominal power**

Nominal power is the maximum permissible continuous power output indicated by the manufacturer for a device or a system. Usually the device is also optimized so that the efficiency is at its maximum in case of operation with nominal power.

**Nominal current**

Nominal current is the absorbed current in case of electrical devices if the device is supplied with the nominal voltage and yields its nominal power.

**NTC**

Abbreviation for negative temperature coefficient

**PE**

In electric systems and cables a protective earth conductor is frequently employed. This is also called grounding wire, protective grounding device, soil, grounding or PE (English „protective earth“).

**Photovoltaics (abbr.: PV)**

The conversion of PV energy into electrical energy.

The name is composed of the component parts: Photos - the Greek word for light - and Volta - after Alessandro Volta, a pioneer in electrical research.

**PLL**

Phase locked loop.

**Power dissipation**

Power dissipation is designated as the difference between absorbed power and power of a device or process yielded. Power dissipation is released mainly as heat.

**PV cell**

PV cells are large-surface photodiodes which convert light energy (generally sunlight) into electrical energy. This comes about by utilization of the photoelectric effect (photovoltaics).

**PV generator**

System comprising of a number of PV modules.

**PV module**

Part of a PV generator; converts PV energy into electrical energy.

**RJ45**

Abbreviation for standardized eight-pole electrical connector connection. RJ stands for Registered Jack (standardized socket).

**RS485 (EIA485)**

Differential voltage interface on which the genuine signal is transmitted on one core and the negated (or negative) signal on the other core.

**RTC**

Abbreviation for Real Time Clock

**Separate grid system**

Energy supply equipment which is completely independent of an interconnected grid.

**Solar inverter**

is an electrical device which converts DC direct voltage into AC voltage and/or direct current into alternating current.

**String**

Designates a group of electrical PV modules switched in series.

**String solar inverter (solar inverter concept)**

The PV generator is divided up into individual strings which feed into the grid over their own string solar inverters in each case. In this way, the installation is considerably facilitated and the gain decrease, which can arise from the installation or from different shading conditions of the PV modules, is considerably reduced.

**UL**

Stands for Underwriters Laboratory, a non-profit organization that sets standards for different product categories and tests products to make sure they meet the standards.

**Voc**

Open Circuit Voltage

**15 Error code**

<b>Error Code</b>	<b>Error Type</b>	<b>Explanation</b>
108	Failure	Configuration record invalid
133	Warning	CRC error after writing internal flash
134	Warning	Error erasing internal flash page
135	Warning	Error writing internal flash page
136	Warning	Internal flash page to be erased is out of range
137	Warning	Internal flash address to be written is out of range
138	Warning	No enough space in internal flash to store config
139	Warning	Error reading from RTC
140	Warning	Error writing to RTC
143	Warning	Get command index failure
144	Warning	More than 100 un-serviced commands
145	Warning	Meteo control command lengths are incorrect
146	Warning	The minimum set of config parameters haven't been set
201	Failure	Internal configure error
202	Failure	NTC error
203	Failure	DAC compensation error
233	Warning	Communication broken
234	Warning	PLL failure
235	Warning	Grid frequency mismatch
236	Warning	Over temperature
301	Failure	Internal configure error
302	Failure	NTC error
303	Failure	DAC compensation error
333	Warning	Communication broken
334	Warning	PLL failure
335	Warning	Grid frequency mismatch

Error Code	Error Type	Explanation
336	Warning	Over temperature
401	Failure	Relay damaged
402	Failure	Residual current CT broken
403	Failure	NTC broken
404	Failure	Internal configure error
405	Failure	Internal communication broken
433	Warning	Isolation resistor low
434	Warning	Residual current high
435	Warning	Temperature high
436	Warning	Temperature low
437	Warning	PV configure failure
438	Warning	External configure failure
439	Warning	PV1 arc fault detection
440	Warning	PV2 arc fault detection
441	Warning	Internal communication failure
465	Info	Auxiliary 13V high
466	Info	Auxiliary 13V low
467	Info	Bulk voltage low
468	Info	PLL unlock
469	Info	Bulk voltage high
470	Info	Grid voltage high
471	Info	Long time grid out



**Delta Products Corporation**

15700 Don Julian Road

City of Industry, CA 91745

Sales Email: [sales.usa@solar-inverter.com](mailto:sales.usa@solar-inverter.com)

Support Email: [support.usa@solar-inverter.com](mailto:support.usa@solar-inverter.com)

Sales Hotline: 1-877-440-5851 or

1-626-369-8021

Fax: 1-626-709-5896

Support Hotline: 1-877-442-4832

Support (Intl.): 1-626-369-8019

Mondays to Fridays from 8:30 am to 5 pm (apart from Holidays)



5013208904 07

