

HYPERLITE
www.hi-hyperlite.com

A good & brand new product. Congrats!
Enjoy brighter life now.

Feel free to contact us
Email: service01@hi-hyperlite.com
Toll-free number: +1(855) 688 7879



RELIABLE SOLID BRIGHT

LED HIGH BAY LIGHT

HERO Series



Certification :



FEATURES & SPECIFICATIONS

Performance Data		CES-LS-HERO-100W	CES-LS-HERO-150W	CES-LS-HERO-200W	CES-LS-HERO-250W
General	Lumens	14000 lm	21000 lm	28000 lm	35000 lm
	Efficacy	140 lm/W			
	CCT	4000K, 5000K			
	Beam angle	120°			
	CRI	>80			
	Life span	>50,000 hours			
	Color finish	Black, White			
Electrical	Power	100W	150W	200W	250W
	Input voltage	AC120-277V			
	Dimming	1 - 10V			
	Power factor	>0.9			
	Temperature	-22°F-113°F(-30°C to 45°C)			-22°F-104°F(-30°C to 40°C)
Physical & Listing	Compatible accessories	1-10V Dimmer, Reflector (Need additional purchase)			
	Mounting	Hook			
	Listing	UL, cUL			
	IP rating	IP 65			
	Warranty	5 Years			

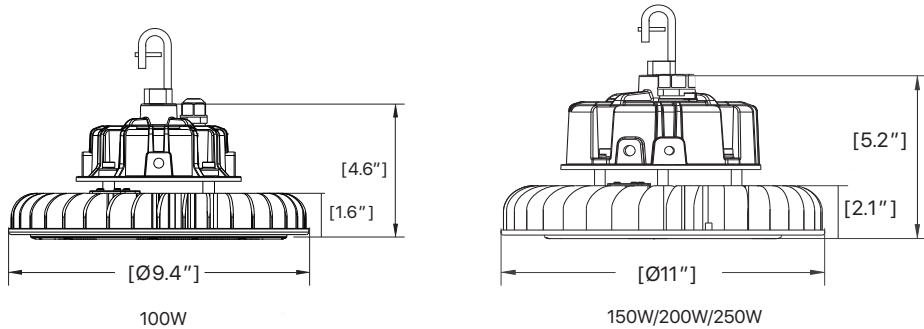

HYPERLITE LED Luminaire

Industrial LED High Bay Lighting (HERO Series)

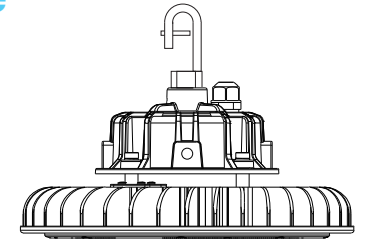

Features

- UL&CUL No E483348 Suitable for Wet Locations.
- IP65 Rated Ingress Protection.

PACKAGING INFORMATION

Model	Wattage	Qty/Ctn	Net Weight	Gross Weight	CTN Size
CES-LS-HERO-100W	100W	1	5.2 ± 1 lbs	6.4 ± 1 lbs	11.8**11.8**7.1"
CES-LS-HERO-150W	150W		7.7 ± 1 lbs	9.8 ± 1 lbs	13.0**13.0**7.6"
CES-LS-HERO-200W	200W		9.0 ± 1 lbs	10.4 ± 1 lbs	
CES-LS-HERO-250W	250W				

ATTENTION

BEFORE YOU INSTALL

Read these instructions completely and carefully.

WARNING

RISK OF ELECTRIC SHOCK

- Turn power off before inspection, installation or removal.
- Properly ground electrical enclosure.
- Follow all NEC and local codes.
- Use only UL or IEC approved wire for input/output connections.

Prepare Electrical Wiring



Electrical Requirements

The LED driver must be supplied with 120-277 VAC, 50/60 Hz per product label and connected to an individual properly grounded branch circuit, protected by a 15 or 20 ampere circuit breaker.



Grounding Instructions

The grounding and bonding of the overall system shall be done in accordance with National Electric Code (NEC) Article 600 and local codes.

120° DISTRIBUTION

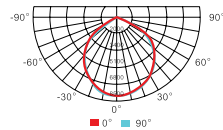

100W/14000lm 53.0fc	150W/21000lm 76.7fc	200W/28000lm 101.2fc	250W/35000lm 141.3fc	10ft
100W/14000lm 13.2fc	150W/21000lm 19.1fc	200W/28000lm 25.3fc	250W/35000lm 35.3fc	20ft
100W/14000lm 7.4fc	150W/21000lm 11.7fc	200W/28000lm 14.2fc	250W/35000lm 19.9fc	26ft
100W/14000lm 4.3fc	150W/21000lm 6.6fc	200W/28000lm 8.2fc	250W/35000lm 12.7fc	33ft
100W/14000lm 2.3fc	150W/21000lm 3.3fc	200W/28000lm 4.2fc	250W/35000lm 6.5fc	46ft

Save These Instructions

Use only in the manner intended by the manufacturer. If you have any questions, contact the manufacturer.

Note: This equipment has been tested and found to comply with the limits for a Class A digital device, pursuant to part 15 of the FCC Rules. These limits are designed to provide reasonable protection against harmful interference when the equipment is operated in a commercial environment. This equipment generates, uses, and can radiate radio frequency energy and, if not installed and used in accordance with the instruction manual, may cause harmful interference to radio communications. Operation of this equipment in a residential area is likely to cause harmful interference in which case the user will be required to correct the interference at his own expense.

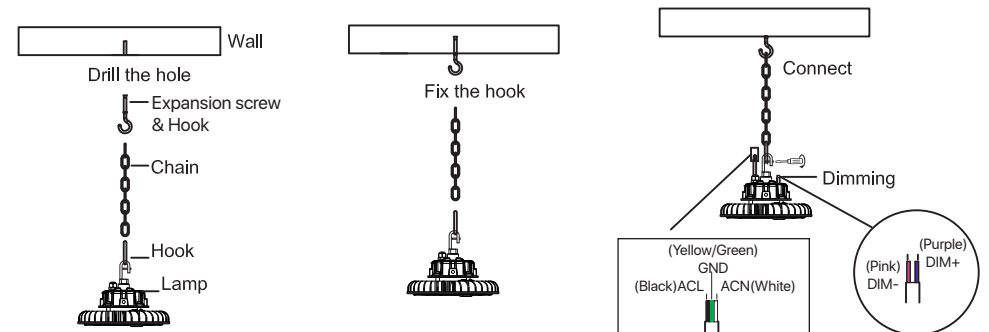

INSTALLATION

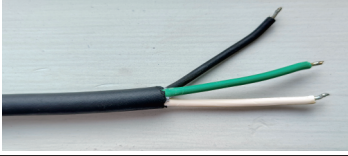
	<p>1. Please check that the plug is in good condition. Install the lamp and plug it into the socket. Then you can test the light fixture.</p>
	<p>2. Please connect the input wire in correct way, black wire is L, white wire is N, green wire is ground connection. Please also make sure the wire connection is fixed perfectly before using.</p>

Announcements:

1. This equipment is only for professional installation. Non-professional personnel shall not remove or install the equipment.
2. Please read the instruction manual before installation and keep it for future reference.
3. To avoid damage, falling, electric shock or fire, please do not modify the lamp or replace accessories without confirming with the supplier.
4. Maintenance/installation and replacement the lamps, please confirm to cut off the power supply, and the lamps have set up a cooling. Please make sure the lamps and has been properly installed before processing power.
5. Ensure the accurate and reliable connection.
6. Ensure that the product around the vent, the lamp cannot violate any fire prevention regulations when using.

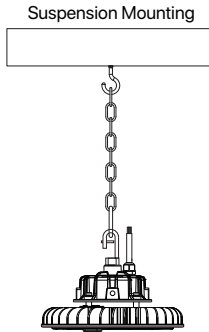

▲ Working Environment



▲ Warehouse

FOOTCANDLE LIGHT GUIDE

Footcandles are the most common unit of measure used by lighting professionals to calculate light levels in businesses and outdoor spaces. A footcandle is defined the illuminance on a one square foot surface from a uniform source of light. The Illuminating Engineering Society (IES) recommends the following footcandle levels to ensure adequate illumination and safety for occupants. Below is a guideline for common areas to assist in achieving appropriate light levels with the greatest energy-efficiency.

Building Area & Task	Average Maintained Footcandles (Horizontal) (FC)	Range of Maintained Footcandles (Horizontal) (FC)	Average Maintained Footcandles (Vertical) (FC)	Range of Maintained Footcandles (Vertical) (FC)	Comments
----------------------	--	---	--	---	----------

WAREHOUSING & STORAGE

Bulky Items—Large Labels	10		5		
Small Items—Small Labels	30		15		
Cold Storage	30-40	10-30	10	5-15	
Open Warehouse	30-40	10-30			
Warehouse w/Aisles	30-40	10-30	10	5-15	

COMMERCIAL OFFICE

Open Office	40	30-50			@30" Above Finished Floor (AFF)
Private Office	40	30-50			@30" AFF
Conference Room	30				Matte surface reflectance for the table 40% recommended
Restroom	18	75-30			
Lunch & Break Room	15	5-20			

EDUCATIONAL (SCHOOLS)

Classroom	40	30-50			@30" AFF
Gymnasium					
Class I (Pro or Div. 1 College)	125		30		
Class II (Div. 2 or 3 College)	80		20		
Class III (High School)	50		150		
Class IV (Elementary)	30		100		
Auditorium	75	3-10	5	2.5-10	
Corridor	25	10-40			

▲ This guide is a collaborative effort of Energy Trust of Oregon and the Lighting Design Lab, Seattle, Washington.

Building Area & Task	Average Maintained Footcandles (Horizontal) (FC)	Range of Maintained Footcandles (Horizontal) (FC)	Average Maintained Footcandles (Vertical) (FC)	Range of Maintained Footcandles (Vertical) (FC)	Comments
INDUSTRIAL/MANUFACTURING					
Assembly					
Simple (Large Item)	30		15	15-60	
Difficult (fine)	100	10-30	10	50-200	
Component Manufacturing					
Large	30	10-30	30	15-60	
Medium	70-80	25-100	50	25-100	
EXTERIOR					
Parking (Covered)	5				1FC min, 10:1 Max to Min Uniformity
Parking (Open) (Medium Activity)					
Lighting Zone 3 (Urban)	1.5	75-3	0.8	0.4-1.6	
Lighting Zone 2 (suburban)	1	0.5-2	0.6	0.3-1.2	
Gas Station Canopy	12.5	10-15			
Safety (Building Exterior)	1	0.5-2			If security is an issue—raise average level to 3
RETAIL					
General Retail (Ambient)		50			
Department Store	40	20 - 80	15	7.5-30	
Perimeter			75	35-150	
Accent Lighting (Displays)					3-10 times greater than ambient light levels
AUTOMOTIVE					
Showroom	70-80	25-100	10	7.5-30	
Service Area	50	25-10	30	15-30	
Sales Lot (Exterior)					
Lighting Zone 3 (Urban)	20	10-40	20	10-40	
Lighting Zone 2 (Suburban)	15	7.5-30	15	7.5-30	
GROCERY					
Circulation	20	10-40	7.5	3.5-15	
General Retail	70-80	25-100	20	10-40	
Perimeter			50	25-100	
BANKING					
ATM	20	10-40	15		Vertical at face of ATM

NOTES:
 • This guide is based on information gathered from the IES 'The Lighting Handbook' 10th Edition. It is highly recommended that all lighting professionals refer to the full IES guide when specifying lighting projects.
 • At least half of users are in the 25 - 65 age range.

• Horizontal—horizontal plane that average maintained foot-candles are measured.
 • Vertical—vertical plane the average maintained foot-candles are measured.
 • It is the responsibility of the to determine and provide appropriate lighting levels for each space.

WIRING DIAGRAM OF DIMMER

Dimmer Without Load

The light power supply is not powered by dimmer, This kind of connection mode is dimmer without load, which don't need to consider load power and load current, only need to consider less than effective optical current 200mA. According to each 0/1-10v adjustable light power signal current of 10mA conservative estimates there are up to 20 dimming power sources can be connected in parallel.

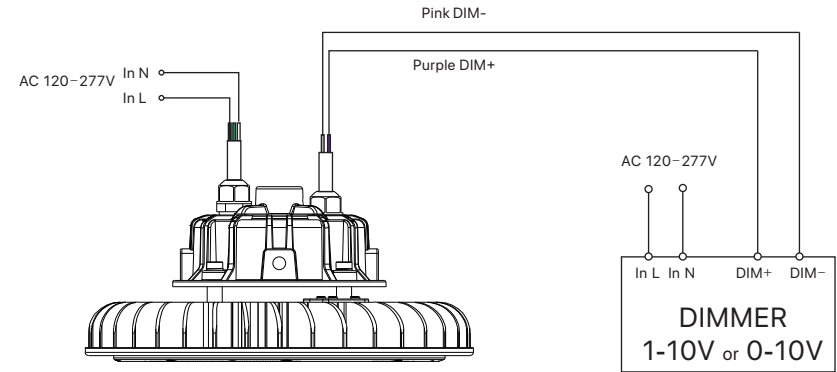

Dimmer With Load

- The light power supply is powered by the dimmer. The light is the load of the dimmer power supply. It is necessary to consider the load power and load current. The maximum effective load of the dimmer is 800W and the current is 10A.
- When Ac120-277V input, effective power is 800W, current is 10A; When Ac120-277V input Effective power is 400W, current is 10A.
- The following is the number of dimmable power supply in parallel of two input voltages.
 - When Ac120-277V input: 800W/100W=8pcs, 10A/2A=5pcs, take the minimum value, so it can Parallel 5 dimming power supply.
 - When Ac120-277V input: 400W/100W=4pcs, 10A/2A=5pcs, take the minimum value, so it can Parallel 4 dimming power supply.

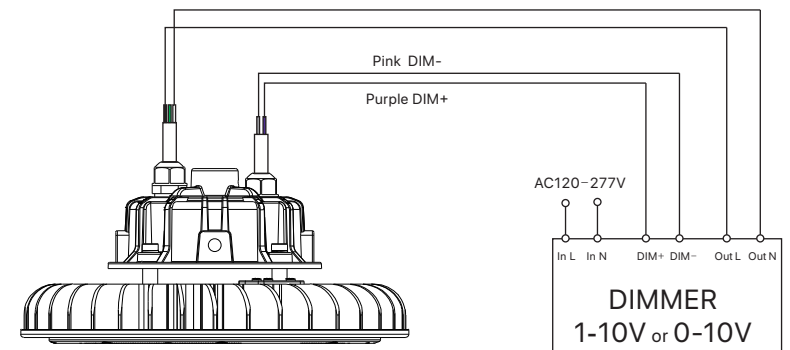

■ LED High Bay Light



Hero Black Series



Hero White Series



Radar Series



Saturn Series



Saturn Series



Will Series

■ LED Flood Light



Mars Series



Eyes Series

■ LED Grow Light

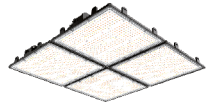

Groplanner O Series

■ Area Light & Canopy Garage Light



Top Series



Vega Series

■ LED Vapor Tight Light



Capsule Series

■ LED Wall Pack Light



Wall. E Series



Moon Series

■ Temporary Work Light



Hive Series



www.hi-hyperlite.com



More products...