

**HYPERLITE**  
www.hi-hyperlite.com

A good & brand new product. Congrats!  
Enjoy brighter life now.

Feel free to contact us  
Email: [service@hi-hyperlite.com](mailto:service@hi-hyperlite.com)  
Toll-free number: +1(855) 688 7879



LED WALL PACK LIGHT

RELIABLE SOLID BRIGHT

**WATTAGE & CCT & PHOTOCELL SELECTABLE GUIDANCE**

**DEFAULT**  
Watt: 80W CCT: 5000K Photocell: ON

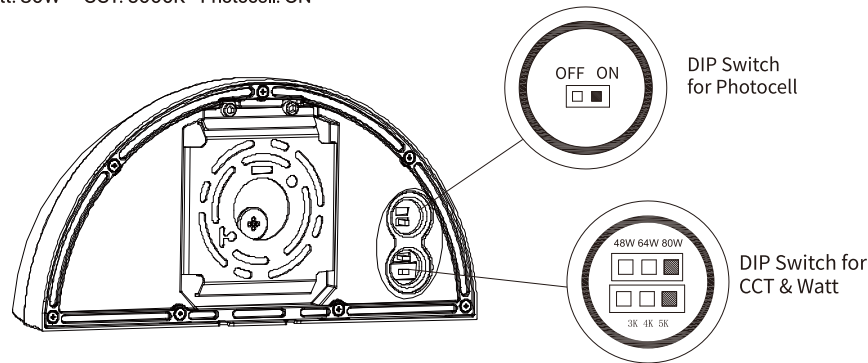

**ATTENTION**

**BEFORE YOU USE**  
Read these instructions completely and carefully.

**WARNING**

**RISK OF ELECTRIC SHOCK**

- Turn power off before inspection, installation or removal.
- Properly ground electrical enclosure.
- Follow all NEC and local codes.
- Use only UL or IEC approved wire for input/output connections.

**Save These Instructions**

Use only in the manner intended by the manufacturer. If you have any questions, contact the manufacturer.

**NOTE!**

- This equipment is only for professional installation. Non- professional personnel shall not remove or install the equipment.
- To avoid damage, falling, electric shock or fire, please do not modify the lamp or replace accessories without confirming with the supplier.
- Maintenance/installation and replacement the lamps , please confirm to cut off the power supply, and the lamps have set up a cooling. Please make sure the lamps properly installed before processing power.

**Prepare Electrical Wiring**



**Electrical Requirements**  
The LED driver must be supplied with 120-277 VAC, 50/60 Hz per product label and connected to an individual properly grounded branch circuit, protected by a 15 or 20 ampere circuit breaker.



**Grounding Instructions**  
The grounding and bonding of the overall system shall be done in accordance with National Electric Code (NEC) Article 600 and local codes.

**INSTALLATION**

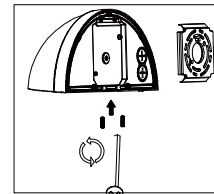

Fig 1

1. Loosen the screws and remove the mounting plate (included) from the removed light fixture.

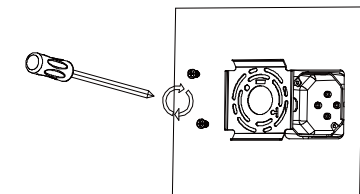

Fig 2

2. Secure the mounting plate to the junction box (Not included).

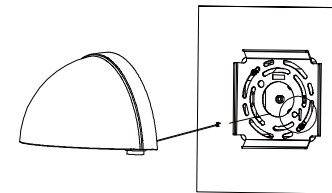

Fig 3

3. Hang the safety rope from the light fixture to the mounting plate

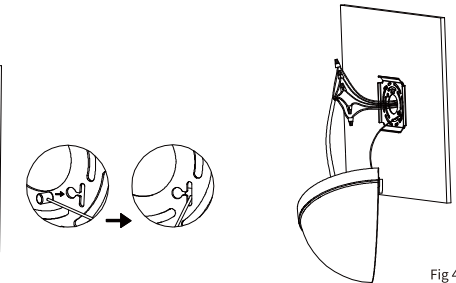

Fig 4

4. Connect the wires of the lamp and the wires of the junction box, as shown in Fig 4

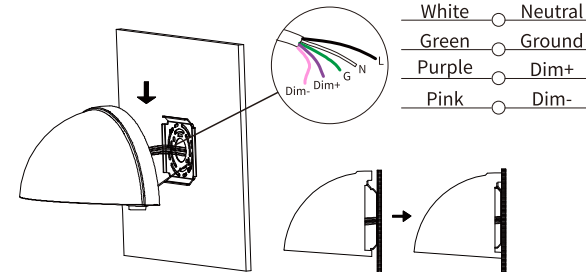

Fig 5

5. Slide the fixture onto the mounting bracket, as shown in Fig 5.

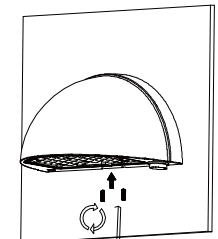

Fig 6

6. Fasten the mounting plate and light fixture with two screws.