



PUFFCO

PEAK PRO INSTRUCTION MANUAL

READ CAREFULLY!

Please read the entire instruction booklet before using your device to ensure you're getting the most out of your Peak Pro. You will avoid damaging your device, or interrupting your experience if you do it now vs. later.

See [Puffco.com/Support](https://puffco.com/support) for instructional videos and helpful tips.

THE PUFFCO PEAK PRO

This guide will show you how to use your Peak Pro including preparation, cleaning, and app connectivity.

- What's inside / p 3 - 4
- What's new / p 5
- Quick start / p 6 - 10
- Temperature settings / p 11 - 12
- Cleaning your device / p 13 - 14
- Advanced features / p 15
- App integration / p 16

WHAT'S INSIDE:

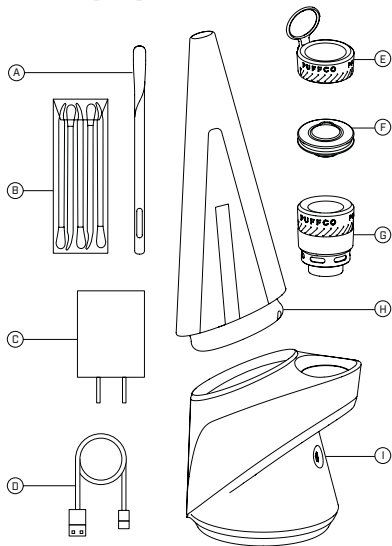

- A: Loading tool F: Oculus Carb Cap*
- B: Dual Tools (5) G: Chamber
- C: AC Adapter H: Glass*
- D: USB-C Cable I: Peak Pro Base
- E: Jacket & Tether J: Carrying Case

*Each glass piece is hand blown and may vary slightly in size.

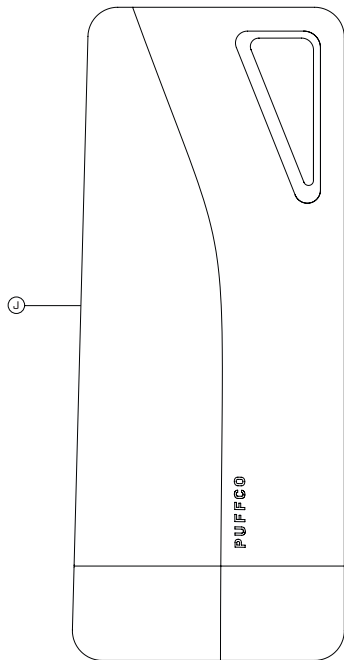

WHAT'S NEW:



Bluetooth App
Enabled



Wireless Charging
(Power Dock sold separately)



USB-C Charging



Real-Time
Temperature Control



Large Capacity
Chamber



Customizable
LED lights

QUICK START:

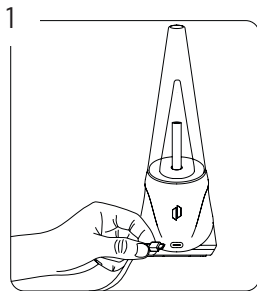

Fully charge the device before first use.
The light color will indicate battery level.
Red (Low) - **Orange** (Half) - **Green** (Full).
Triple-click to check battery level.

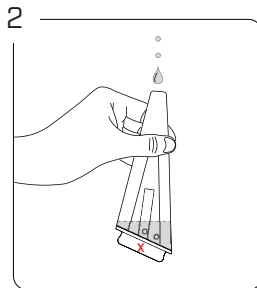

Fill glass with water just above the air-holes.
Do not fill glass while attached to base.
X - Do not allow water into lower section!

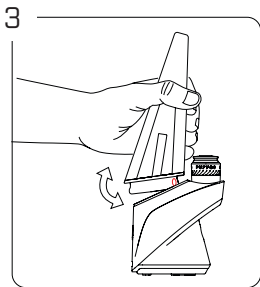

Align inlet hole on the front of the glass with chamber. Carefully push the front of glass into the base, then push the back down.

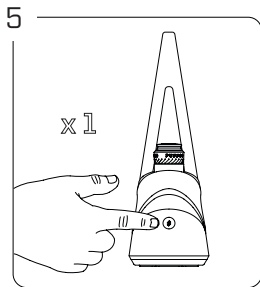

Single click to toggle through heat settings.
 Blue [Low] - Green [Medium]
 RED [High] - White [Peak]

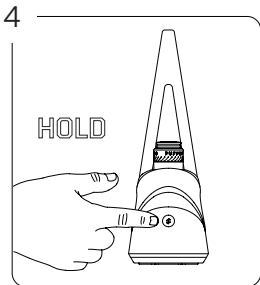

To unlock / lock the device, hold down the button for 3 seconds.

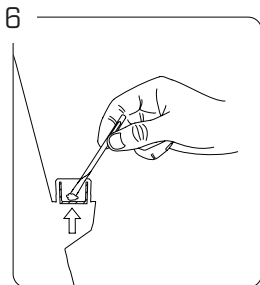

Use loading tool or a Puffco Dual Tool to place contents on the bottom surface of the bowl (not the sides).

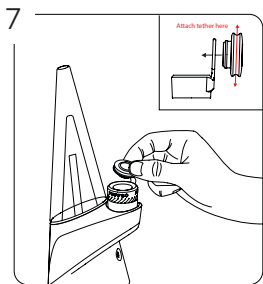

Place carb cap on top of chamber. Press down until snug. Use the included chamber jacket & tether to keep it safe during use.

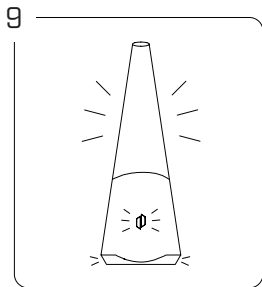

Device will vibrate and lights will flash 3 times when ready. Inhaling gently will produce the best results. *See p. 15 for boost mode.

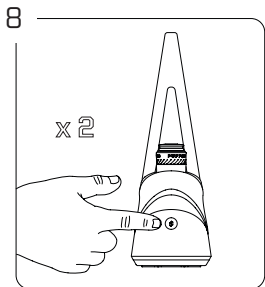

Double click to initiate heat-up. Press and hold button anytime to exit. Pulsing light indicates heat-up mode is active.

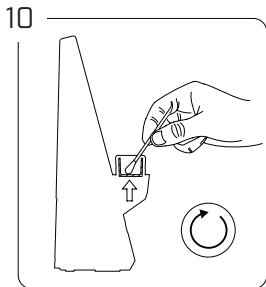





Use a cotton swab or Dual Tool to clean the chamber after each use. Wipe gently in a circular motion.

TEMPERATURE SETTINGS:

HOW TO CHOOSE A SETTING

1. Ensure device is on.
2. Click once to cycle through each heat level.
3. Double click to initiate heat-up.

COLOR	TEMP. °F
	PEAK - 545
	HIGH - 530
	MED - 510
	LOW - 490

 These are the default color and temperature settings. They are further customizable through the app.

HEAT SETTING PROFILES:

Each heat setting has an intended purpose and results depending on the experience you're looking for. There is no wrong answer when selecting a setting, experiment to find what works best for you and your consumption needs.

PEAK (ADVANCED)

Delivering the most vapor and strength with less flavor.

HIGH (STRONG)

Higher vapor production while maintaining flavor quality.

MED (BALANCED)

Balanced flavor and vapor production, best of both worlds.

LOW (HIGH FLAVOR)

Best with delicate concentrates. Optimal flavor and lowest vapor production.

CLEANING: CHAMBER



1. Remove the cap and unscrew the chamber from the base.

 Do not handle if hot.



2. Light Cleaning:
Use a cotton swab to gently remove any residue with 90%+ isopropyl alcohol.



3. Deep Cleaning:
Submerge the chamber in 90%+ isopropyl alcohol for 20 minutes. Never use water (isopropyl alcohol only).

 Isopropyl alcohol is highly flammable. Let it dry completely before heating device.

CLEANING: BASE

Preparation: Remove glass and chamber.

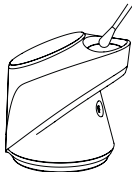

Gently clean the gold contact points using cotton swabs soaked in isopropyl alcohol.

Clean the airpath between the chamber and the glass.

Do not allow water into the base at any time.

CLEANING: GLASS

Preparation: Carefully remove glass from base.

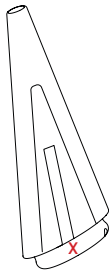

1. Once removed, submerge in isopropyl alcohol.

2. After soaking, remove from isopropyl alcohol and rinse clean with water. (Make sure it's rinsed thoroughly prior to use.)

Allow glass to thoroughly dry before re-attaching to base.

X - Do not re-insert glass onto base with water in the bottom chamber.

GENERAL WARNINGS:

- Do not overfill the chamber.
- Do not blow or exhale hard into the glass. This will force water into the base.
- Do not store device with water in the glass, unless you have the Puffco Travel Glass.
- Strong inhales may cause spillage and damage to your chamber.
- Do not charge or operate below 32° F or above 100° F.
- Use only with the provided cable and power adapter.
- Keep away from moisture and high humidity.
- Store in a cool dark place when not in use.
- During use the chamber is hot (burn hazard).

ADVANCED FEATURES:

BOOST MODE:

After heatup, double click to activate boost mode. This extends the time and/or increases the temperature of your hit. You can continue to boost as needed. By utilizing the app, you can customize the desired time and temperature of your boost.

READY MODE [APP]:

*The Peak Pro Power Dock and mobile app are required to activate ready mode.

Once the Peak Pro is paired with a mobile device, enable "Ready Mode" found in the Peak Pro app settings.

Your device will now automatically initiate the selected heat profile when lifted from Peak Pro Power Dock.

STEALTH MODE:

Rapidly click 4 times to turn Stealth Mode on/off. This turns off the lights on your device for discretion.

ERROR CODES:

- 1: No chamber (3 white flashes)
- 2: Chamber error (red blue red blue)
- 3: Device overheating (red for 5 seconds)
- 4: Low battery (3 red flashes)

APP INTEGRATION:

The Peak Pro app integration has a wealth of new features that allow you to customize your experience, unlock special features, and more.

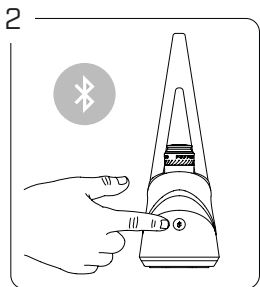

Hold the button for 6 seconds to sync your Peak Pro with your app. The device will turn on/off, keep holding until glows blue.



NEED HELP? CONTACT US!

***Please do not return your Peak Pro to the store.**

***Keep your proof of purchase.**

If you're having anything less than a perfect experience, reach out to our support team.

1. Use the App!

The app gives us important diagnostic information about your device. Fill out a warranty claim form there for the fastest service possible.

2. Visit Puffco.com/Support

For FAQ's, how-to videos, and other resources that may solve your problem quickly.



SHARE THE VIEW:

Use #PuffcoPeak to share your experience.

Kindly follow us on Instagram!





AOK_ZZ20_D

by Puffco Creation Labs - Subject to alterations · All rights reserved