

Installation Manual
THM-0500 Touch Screen Programmable Thermostat
Version 2.06



HBX

THM-0500

HBX Control Systems Inc.

TABLE OF CONTENTS

Introduction	Index
Safety symbols and Warnings	Index
Receipt and Inspection	1
Description	1
Technical data and dimensions	1
Programming THM-0500	2 - 15
- Navigating the THM-0500	2
- Setting the THM-0500	2 - 5
- Special Functions	2 - 6
- Setup Menu	7 - 19
Installation and Wiring	20-22
Troubleshooting Guide	23-24
Limited Warranty	25

INTRODUCTION

This manual will help with the installation, parameter setting, troubleshooting and general maintenance requirements for the controller. To guarantee the safe and reliable operation of this control, you must first read this manual in detail and take particular note to any and all warnings or caution directives prior to connecting to AC power.

Only suitably qualified individuals with formal training in electrical and HVAC controls should attempt the installation of this equipment. Incorrect wiring and installation will affect the warranty provided with this unit. Wiring must be completed in accordance with the codes and practices applicable to the jurisdiction for the actual installation.

The HBX THM-0500 is a microprocessor based controller and as such is not to be regarded as a safety (limit) control. Please consult and install the heating or cooling appliance in accordance with the manufacturer's recommendations.



SAFETY SYMBOLS AND WARNINGS

DRAWING REFERENCE

Refer to the specified electrical or mechanical drawing at the back of the manual.



PRECAUTION

A measure taken in advance to prevent dangerous or an unpleasant event



WARNING: This product can expose you to chemicals including lead, which is known to the State of California to cause cancer and birth defects or other reproductive harm. For more information go to www.P65Warnings.ca.gov.

RECEIPT & INSPECTION

After receiving, inspect the unit for any possible physical damage that may have occurred during transportation. After unpacking the unit make sure the box contains:

- 1 x Universal sensor (Part #029-0045)
- 1 x Thermostat THM-0500
- 1 x Thermostat Wall Cutout Template
- Instruction Manual

DESCRIPTION

The THM-0500 is a programmable thermostat designed to be used with the ZON-0550 Zone Control, optional Wi-Fi™ ThermoLinX™ Module, and ThermoLinX mobile app. The thermostat has four daily, automatic settings (wake, day, evening, sleep) and weekend settings.



It is normal for the THM-0500 screen to remain off up to 120 seconds upon start-up.

The THM-0500 has two external sensor inputs, multiple heating/cooling modes and can function as a digital setpoint/aquastat.

Some features of the THM-0500 are:

- Dual stage heating or cooling
- P.I.D. algorithm
- Large, full colour touch screen display
- Humidity Control
- Includes external sensor



The THM-0500 is only compatible with the ZON-0550 Zone Control

TECHNICAL DATA AND DIMENSIONS

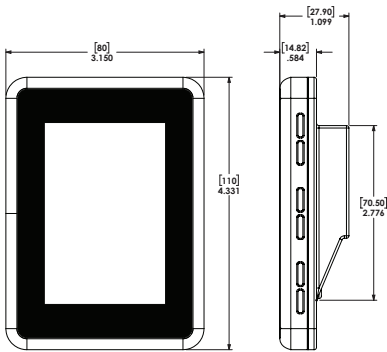

Front View

Side View

Bottom View

Technical Data

2 x External Thermistor Input
1 x Power and Communication
1 x Humidity Sensor

Input power: 5VDC 120mA

Dimensions: 80 x 110 x 26mm

ETL Listings:

Only used with ZON-0550
ETL Control No. 3068143

Storage: +10C to +40C

Languages: English

PROGRAMMING THM-0500

NAVIGATING THE THERMOSTAT

The touchscreen of this thermostat makes it easy to change used settings. Touch any item to adjust its setting excluding the time on the home screen.

Simply touch the temperature to adjust your desired target temperature. Pressing the  menu icon on top right corner allows you to view the main "Setup Menu" options. Pressing the back icon allows you to return to the home screen or setup menu.

Touching the area below the current temperature allows you to see what current demands are present.

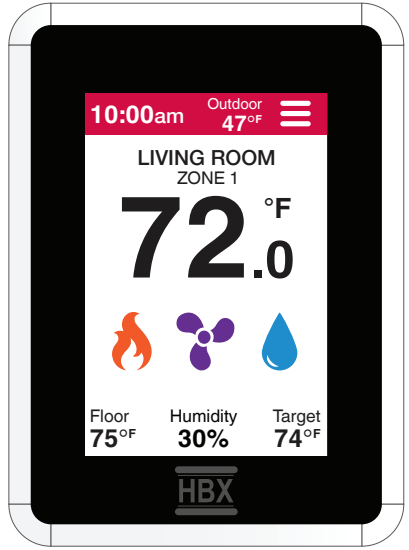

How to set target temperature

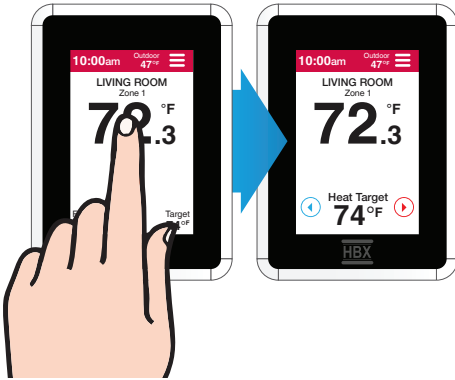

How to see Current Demand

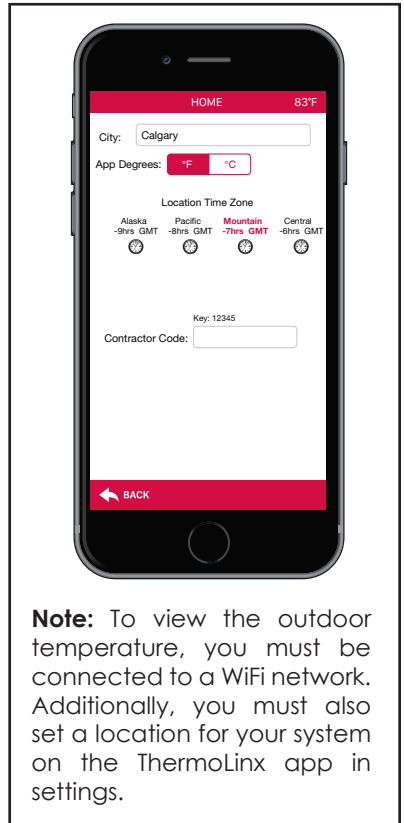
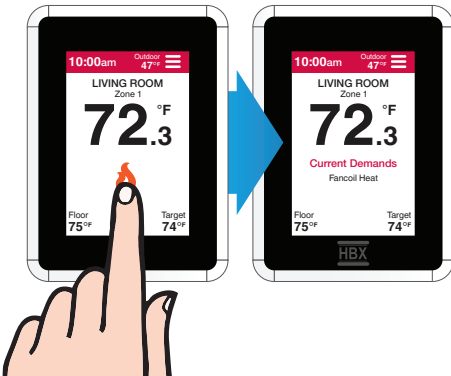

Note: To view the outdoor temperature, you must be connected to a WiFi network. Additionally, you must also set a location for your system on the ThermoLinx app in settings.

SETTING THE THERMOSTAT

Special Functions

Enter the “**Special Functions**” screen by touching and holding down the  menu icon for 5 seconds (from the status screen). To select the desired option, simply touch any item to adjust it's setting.

Lockout Thermostat

In the special functions menu, press and hold the  lock icon on the top right corner for 20 seconds. The screen will automatically go to the main screen and the thermostat will display a lock icon.



No settings will be able to be changed when the thermostat is locked. Only on the Thermolinx mobile app you will have the ability to still make changes.

When the Thermostat is locked, only minimal temperature target adjustment can be made. 2°C/3°F above/under.

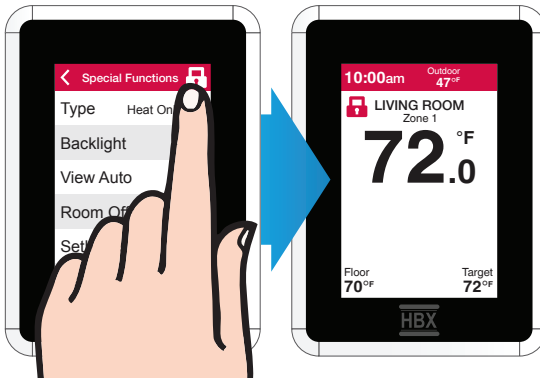

Unlock Thermostat

In the special functions menu, press and hold the lock icon on the top right corner for 20 seconds. The screen will automatically go to the main screen and the lock icon will no longer appear.



When the thermostat is locked the menu bar is no longer displayed. To access special functions, hold the spot where the icon would appear (top right corner).

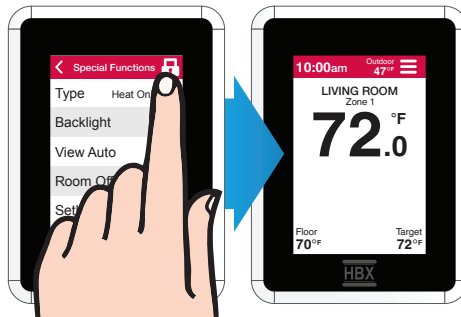

Type - Select between Heating, Cooling, and a variety of combined modes.

Functions	
Type	Heat Only
Backlight	✓
View Auto	✓
Room Offset	0°F
Setbacks	✗
Geo Mode	✗

Heat Only Function

Select the "Heat Only Function" for applications using a single heating source.

Functions	
Type	Cool Only
Backlight	✓
View Auto	✓
Room Offset	0°F
Setbacks	✗
Geo Mode	✗

Cool Only Function

Select the "Cool Only Function" for applications using a single cooling source.

Functions	
Type	Heat and Cool
Backlight	✓
View Auto	✓
Room Offset	0°F
Setbacks	✗
Geo Mode	✗

Heat and Cool Function

Select the "Heat and Cool Function" for applications using a single heating source and a single cooling source.

Functions	
Type	2 Stage Heat
Backlight	✓
View Auto	✓
Room Offset	0°F
Setbacks	✗
Geo Mode	✗

2 Stage Heat Function

Select the "2 Stage Heat Function" for applications using 2 stage heating.

Functions	
Type	2 Stage Cool
Backlight	✓
View Auto	✓
Room Offset	0°F
Setbacks	✗
Geo Mode	✗

2 Stage Cool Function

Select the "2 Stage Cool Function" for applications using 2 stage cooling.

Functions	
Type	2 Heat with Cool
Backlight	✓
View Auto	✓
Room Offset	0°F
Setbacks	✗
Geo Mode	✗

2 Heat with Cool Function

Select the "2 Heat with Cool Function" for applications using 2 stage heating and 1 stage cooling.

Functions	
Type	2 Cool with Heat
Backlight	✓
View Auto	✓
Room Offset	0°F
Setbacks	✗
Geo Mode	✗

2 Cool with Heat Function

Select the "2 Cool with Heat Function" for applications using 2 stage cooling and 1 stage heating.

Functions	
Type	2 Heat and 2 Cool
Backlight	✓
View Auto	✓
Room Offset	0°F
Setbacks	✗
Geo Mode	✓

2 Heat and 2 Cool Function

Select the "2 Heat and 2 Cool Function" for applications using 2 stage heating and 2 stage cooling.

This option is only available in Geo Mode. You must set Geo mode to ✓ to enable this function.

Functions	
Type	2 Heat/1 Cool
Backlight	✓
View Auto	✓
Room Offset	0°F
Setbacks	✗
Geo Mode	✗

Backlight

This option allows you to dim the idle mode screen to a darker setting.

ex. For bedrooms or living rooms

Functions	
Type	2 Heat/1 Cool
Backlight	✓
View Auto	✓
Room Offset	0°F
Setbacks	✗
Geo Mode	✗

View Auto

This feature allows you to choose between automatic changeover or manual changeover. Changeover refers to the thermostat being switched from heat to cool as the air crosses a certain temperature. Auto changeover switches from heat to cool automatically while manual changeover thermostats must be changed by hand. If you select ✗, changeover will not appear in the “**Adjustment Screen**”.

Applicable to: Heat/Cool, 2Heat/Cool, 2Cool/Heat and 2Heat/2Cool modes.

Functions	
Type	2 Heat/1 Cool
Backlight	✓
View Auto	✓
Room Offset	0°F
Setbacks	✗
Geo Mode	✗

Room Offset

This feature allows you to program an offset. In the case that the thermostat is not reading the same temperature as the actual temperature in the room. This setting allows the used to offset the temperature showing on the thermostat.

eg. Actual Room Temperature 72 °F.

Direct Sunlight causes Thermostat to show 73 °F.

The user can put an offset of -1 °F to get the temperatures to match.

Functions	
Type	2 Heat/1 Cool
Backlight	✓
View Auto	✓
Room Offset	0°F
Setbacks	✗
Geo Mode	✗

Setbacks

Allows you to program a setback. A setback can be programmed to maximize energy during time frames where the zone may be vacant.

When you select ✓ you can program up to 4 setback time periods in the schedules menu.

Functions	
Type	2 Heat/1 Cool
Backlight	✓
View Auto	✓
Room Offset	0°F
Setbacks	✗
Geo Mode	✗

Geo Mode

This feature allows you to control 2 or 4 pipe systems for geothermal applications. This allows for 2 stage heat and 2 stage cool functions.

This mode can only be turned on/off using the first THM-0500 thermostat connected to the ZON-0550 Controller. (THM1)

Default: 2 pipe system. To change to a 4 pipe system, go to zone setup options (page 12).

Setup Menu

Pressing the  menu icon on the top right corner allows you to view the main "Setup Menu" options. Pressing the back icon allows you to return to the home screen or setup menu. Once you are in the setup menu, to select the desired option, simply touch any item to adjust its setting.

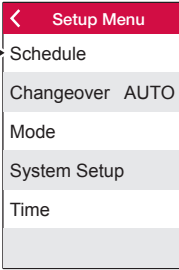

Setback Schedule

Simply touch schedule on the display to bring up schedule options.

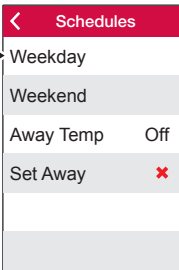

Schedule: Weekday Programs

Adjust four time periods within the weekday program menu. The "Back" option allows the user to return to the previous screen.

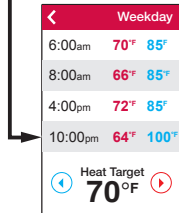

Cooling Programs

A cooling setpoint is available when the thermostat has been chosen to have any cooling function.



There must be a minimum of 2°F differential between hot and cold settings. Cooling must be a minimum of 2°F higher than Heating.

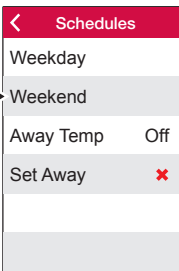

Schedule: Weekend Programs

Adjust four time periods within the weekend program menu. The "Back" option allows the user to return to the previous screen.

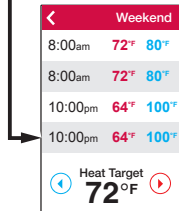

Cooling Programs

A cooling setpoint is available when the thermostat has been chosen to have any cooling function.



There must be a minimum of 2°F differential between hot and cold settings. Cooling must be a minimum of 2°F higher than Heating.

Schedules	
Weekday	
Weekend	
Away Temp	Off
Set Away	✘

Schedule: Away Temperature

Set the temperature for when the zone is in Away Mode. Away Mode can only be set on the thermostat if setbacks are enabled in the System Function screen options.

Away mode will override the schedule to a lower/higher temperature.

Schedules	
Weekday	
Weekend	
Away Temp	Off
Set Away	✘

Schedule: Set Away

Select ✔ to set the zone to Away Mode.

Setup Menu	
Target Temp	72°F
Changeover	AUTO
Mode	
System Setup	
Time	

Target Temperature

When Setbacks are set to ✘, use this to change the minimum/maximum temperature for your zone depending on if your zone is set up for heating or cooling. If the temperature in the zone falls below/ rises above this temperature, heating or cooling will come on.

Setup Menu	
Heating Temp	72°F
Cooling Temp	80°F
Changeover	AUTO
Mode	
System Setup	
Time	

Heating Temperature

Change the minimum temperature for your zone. If the temperature in the zone falls below this temperature, heating will come on.

This setting only applies to heating/cooling modes.

Setup Menu	
Heating Temp	72°F
Cooling Temp	80°F
Changeover	AUTO
Mode	
System Setup	
Time	

Cooling Temperature

Change the maximum temperature for your zone. If the temperature in the zone increases above this temperature, cooling will come on.

This setting only applies to heating/cooling modes.

Setup Menu	
Schedule	
Changeover	AUTO
Mode	
System Setup	
Time	

Changeover

Auto: this option allows you to change automatically from heat mode to cool mode or vice versa

Heat: Allows the user to be only in heat mode

Cool: Allows the user to be only in cool mode

This option is only available when you select "YES" in View Auto options in the Special Functions screen.

Applicable to: Heat/Cool, 2Heat/Cool, 2Cool/Heat and 2Heat/2Cool modes.

Setup Menu	
Schedule	
Changeover AUTO	
Mode	
System Setup	
Time	

MODE OPTIONS

This option allows you to select between Room, Floor and Dual sensor modes.

If you are setting your Thermostat as a **DHW Zone**, see **Zone Demand** on page 9. Selecting **DHW** will automatically configure your sensor.



If you are using an external room thermistor, see page 13 for thermistor switch settings.

THERMOSTAT OFF

Mode Setup	
Thermostat	Off
Zone Valve	Off
Mode	Room
Sensor 1	Floor

Thermostat Off

When set to OFF, the thermostat will disable the ability to make a heating or cooling demand. All other features will still be available.

Mode Setup	
Thermostat	Off
Zone Valve	Off
Mode	Room
Sensor 1	Floor

Zone Valve

When set to ON, The zone will be utilizing a zone valve or actuator. There will be a 60 second delay for the system pump to turn on when there is a heat or cool demand.

ROOM MODE OPTION

Mode Setup	
Thermostat	Off
Zone Valve	Off
Mode	Room
Sensor 1	Floor

Room Mode

Sensor temperature providing feedback for the specific room or zone being controlled by the thermostat.

Mode Setup	
Thermostat	Off
Zone Valve	Off
Mode	Room
Sensor 1	Floor

Room Mode: Sensor 1

None – No external thermistor attached.

RM/Ave – averages external 1 and internal sensor, or optional external room sensor (see page 13 for instructions).

Outdoor – Uses external sensor to display outdoor temperature.

Room - disregards internal sensor, uses external 1.

Floor – displays the floor temperature using external 1 sensor.

DUAL MODE OPTION

Mode Setup	
Thermostat	Off
Zone Valve	Off
Mode	Dual
Floor Max	80°F
Floor Min	70°F
Sensor 1	Floor

Dual Mode

Sensor temperature providing feedback for both the air temperature and floor sensor temperatures.



Only available when heating modes are the primary function.

Mode Setup	
Thermostat	Off
Zone Valve	Off
Mode	Dual
Floor Max	80°F
Floor Min	70°F
Sensor 1	Floor

Dual Mode: Floor Maximum

The thermostat will not allow the temperature in the floor to go above this value, protecting the integrity of the floor covering.

If in a 2 stage heating mode, only the radiant heating contact is turned off.

Mode Setup	
Thermostat	Off
Zone Valve	Off
Mode	Dual
Floor Max	80°F
Floor Min	70°F
Sensor 1	Floor

Dual Mode: Floor Minimum

The thermostat will not allow the temperature in the floor to go below this value, protecting the integrity of the floor covering.

Mode Setup	
Thermostat	Off
Zone Valve	Off
Mode	Dual
Floor Max	80°F
Floor Min	70°F
Sensor 1	Floor

Dual Mode: Sensor 1

This option will be automatically set to floor sensor.

FLOOR MODE OPTION

Mode Setup	
Thermostat	Off
Zone Valve	Off
Mode	Floor
Floor Max	5°F
Sensor 1	Floor

Floor Mode

Sensor temperature providing feedback from the floor surface to the thermostat. This mode will run the thermostat on floor temperature only.



Only available when heating modes are the primary function.

Mode Setup	
Thermostat	Off
Zone Valve	Off
Mode	Floor
Floor Max	5°F
Sensor 1	Floor

Floor Mode: Differential

When in floor mode, the differential option is set to allow a differential around the target to lesson the chances of short cycling.

Ex. A differential of 4°F is 2°F above the setpoint and 2°F below the setpoint.

Mode Setup	
Thermostat	Off
Zone Valve	Off
Mode	Floor
Floor Max	5°F
Sensor 1	Floor

Floor Mode: Sensor 1

This option will be automatically set to floor sensor.

Setup Menu	
Schedule	
Changeover	AUTO
Mode	
System Setup	
Time	

SYSTEM SETUP OPTIONS

This selection allows you to access the System Setup menu.

ZONE SETUP OPTIONS

System Setup	
Zone Setup	
Fancoil Setup	
Humidity Setup	
Degrees	°F
Stage Delay	15 Mins
Sync-Code: AAAA-1234	

Zone Setup

This setting takes you to the Zone Setup Menu.

Zone Setup	
Sequence	1 - 4
Demand	Low
Priority	None
Password	AB12
Master ID:	A2
Damper Zone	off

Zone Setup: Sequence

This option allows the user to set the zone module sequence order. Select the sequence you would like to set up for the module (1-4, 5-8, 9-12, 13-16, 17-20). Adjusting the sequence order can only be done using the first THM-0500 (zone 1) thermostat that is connected to the zone module (ZON-0550).

Ex. Sequence order 5-8 are zones 5, 6, 7 and 8.



Selecting sequence order (1-4) will set the zone module as the "master".

Zone Setup	
Sequence	1 - 4
Demand	Low
Priority	None
Password	AB12
Master ID:	A2
Damper Zone	off

Zone Setup: Demand

This option allows the user to determine what happens when the thermostat makes a call.

Low - Low Temperature Demand

High - High Temperature Demand

DHW - Domestic Hot Water (Digital Aquastat)

Fan - Fancoil Demand

Geo - Only available when geo mode is enabled, see page 5

Zone Setup	
Sequence	1 - 4
Demand	Low
Priority	None
Password	AB12
Master ID:	A2
Damper Zone	Off

Zone Setup: Priority

This option allows the user to set a priority on a zone(s) over other zone(s). Priorities range from 1 (highest) to 7 (lowest). Higher priorities will lock out lower priorities until the demand has been satisfied. Multiple zones can be given the same numbered priority.

The Priority Shield option allows a zone to ignore other priorities from other zones.



Priority 1 is a timed priority of 60 minutes, generally used for DHW.

Zone Setup	
Sequence	1 - 4
Demand	Low
Priority	None
Password	AB12
Master ID:	A2
Damper Zone	Off

Zone Setup: Password

This option allows the user to see the password to connect to the ThermoLinX App.

Selecting this option allows you to change the password.

No - Password will remain the same

Yes - The Thermostat will randomly generate a new password.

Zone Setup	
Sequence	1 - 4
Demand	Low
Priority	None
Password	AB12
Master ID:	A2
Damper Zone	Off

Zone Setup: Master ID

With this option, if the thermostat is connected to the first zone module it will display the master ID. If selected it will put the module into "**Discovery mode**".

If the thermostat is connected to additional zone modules, it will indicate the ID of the master module it is paired to. If selected it will put the module into pairing mode.

Zone Setup	
Sequence	1 - 4
Demand	Low
Priority	None
Password	AB12
Master ID:	A2
Damper Zone	Off

Zone Setup: Damper Zone

This option allows you to utilize the zone output as a damper zone.

Default: OFF

Off: No damper being utilized in current setup.

Single N/O: Corresponding zone output is utilizing normally open dampers.

Single N/C: corresponding zone output is utilizing normally closed dampers.

2 Stage N/O: 1st stage is radiant and the second stage is utilizing a normally open damper. Utilizing this option will require to use the next corresponding zone output to accommodate for the second stage damper. This option is only available for Zones 1 and Zone 3.

2 Stage N/C: 1st stage is radiant and the second stage is utilizing a normally closed damper. Utilizing this option will require to use the next corresponding zone output to accommodate for the second stage damper. This option is only available for Zone 1 and Zone 3.

Zone Setup	
Sequence	1 - 4
Demand	Low
Priority	None
Password	AB12
Master ID:	A2
4 Pipe Zone	✘

Zone Setup: 4 Pipe Zone (Geo Mode Only)

This option allows you to control a 4 pipe system in a geothermal application. This option is available when Geo Mode is selected. This option is only available for Zone 1 and 3.

Default: ✘

FANCOIL SETUP OPTIONS

< System Setup	
Zone Setup	
Fancoil Setup	
Humidity Setup	
Degrees	°F
Stage Delay	15 Mins
Sync-Code: AAAA-1234	

Fancoil Setup

This setting takes you to the Fancoil Setup Menu.

< Fancoil Setup	
Fan on demand	✖
Zone on demand	✖
Temp Average	None
Fan Mode	✖

Fancoil Setup: Fan On Demand

This option will turn the fan on with any fancoil demand.

< Fancoil Setup	
Fan on demand	✖
Zone on demand	✖
Temp Average	None
Fan Mode	✖

Fancoil Setup: Zone On Demand

This option will turn the zone pump on with any fancoil demand.

< Fancoil Setup	
Fan on demand	✖
Zone on demand	✖
Temp Average	1 - 4
Fan Mode	✖

Fancoil Setup: Temperature Averaging

This option will average the temperature between thermostats (User Selectable), when that average falls below or above the setpoint, depending on if it's in heating or cooling, then the thermostat will make a call for heating or cooling on the fancoil.

< Fancoil Setup	
Fan on demand	✖
Zone on demand	✖
Temp Average	None
Fan Mode	✖

Fancoil Setup: Fan Mode

OFF: Fan is off

ON: Enables the fan to run constantly, regardless of whether the thermostat is calling for heating or cooling

INT: This setting will set the ON/OFF time for the intermittent fan

*Ex: The fan will come on for **15 min** every **2H**. Set (Int Fan On: **15 min**) & (Int Fan Off: **2H**)*

← Fancoil Setup	
Fan on demand	✘
Zone on demand	✘
Temp Average	None
Fan Mode	Int
▶ Int Fan ON	2 mins
Int Fan OFF	2 hrs

Fancoil Mode INT: Intermittent Fan On

Sets the amount of time the fan will operate. Only applicable when Fan Mode is set to **INT**.

← Fancoil Setup	
Fan on demand	✘
Zone on demand	✘
Temp Average	None
Fan Mode	Int
▶ Int Fan ON	2 mins
Int Fan OFF	2 hrs

Fancoil Mode INT: Intermittent Fan Off

Sets the amount of time that must pass before the fan can come on again. Only applicable when Fan Mode is set to **INT**.

HUMIDITY SETUP

← System Setup	
Zone Setup	
Fancoil Setup	
▶ Humidity Setup	
Degrees	°F
Stage Delay	15 Mins
Sync-Code: AAAA-1234	

Humidity Setup

This setting takes you to the Humidity Setup Menu.

← Humidity Setup	
▶ Use Humidity	✔
Target	40%
Type	Humidify
Fan ON Humidity	✔

Humidity Setup: Use Humidity

ON: Enables the thermostat to humidify or dehumidify.

OFF: Disables the Thermostat to humidify or dehumidify.

Auto: Enables the thermostat to humidify or dehumidify to the target % automatically based on the outdoor temperature. No manual adjustment is required. The zoning system must be connected to a wifi network for this feature to be applicable or the thermostat must utilize an external sensor monitoring the outdoor temperature.



You must enter your location on the ThermoLinx app for Auto Humidity to work.

◀ Humidity Setup	
Use Humidity	✓
▶ Target	40%
Type	Humidify
Fan ON Humidity	✓

Humidity Setup: Target

When humidity is set to ON, use this setting to manually adjust your humidity target.

◀ Humidity Setup	
Use Humidity	✓
▶ Target	40%
Type	Humidify
Fan ON Humidity	✓

Humidity Setup: Type

This option allows you to set the thermostat to humidify or dehumidify.

◀ Humidity Setup	
Use Humidity	✓
▶ Target	40%
Type	Humidify
Fan ON Humidity	✓

Humidity Setup: Fan ON Humidity

This option will turn on your fan when there is a humidity demand.

CELSIUS OR FARENHEIT

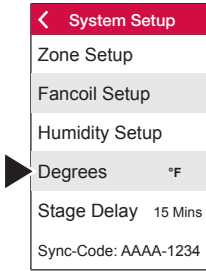

Degrees

This option will change the thermostat temperature to either Celsius or Farenheit.

STAGE DELAY

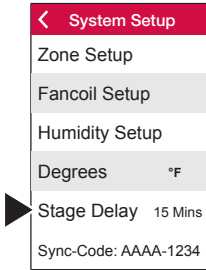

Stage Delay

Use this setting to adjust the lagtime between stage 1 and stage 2 coming on.

Default: 15m

Range: 1m - 240m



This option is only available in 2 stage applications.

SYNC CODE

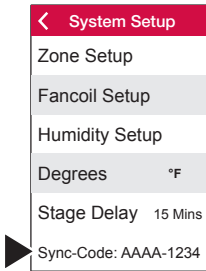

Sync Code

This number is the identifier used in the HBX ThermoLinx App to connect to your thermostat.

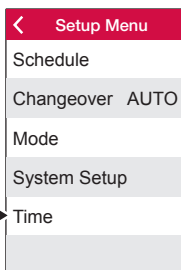

TIME OPTIONS

This selection allows you to access the System Setup menu.

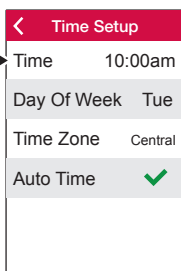

Time Setup: Time

Set the time for your appropriate time zone.

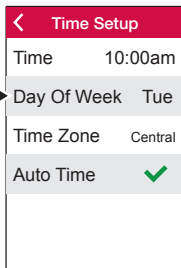

Time Setup: Day of Week

Set the current day of the week.

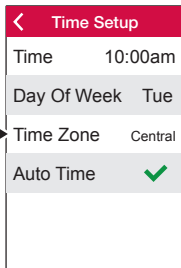

Time Setup: Time Zone

Set the appropriate time zone for your area.

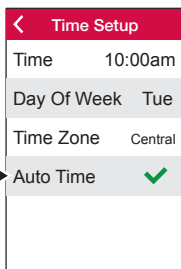

Time Setup: Auto Time

Use this setting to allow the network to automatically update your time when WiFi is enabled on your system

INSTALLATION AND WIRING

MOUNTING INSTRUCTIONS

In order to assure proper room temperature, it is important to identify the ideal location of the thermostat. It should be approximately 5 feet from the floor and at least 1 foot from door openings on an interior wall. Avoid exposing the thermostat to direct sunlight, to air flows (doors, windows, etc.) as well as to heat sources.

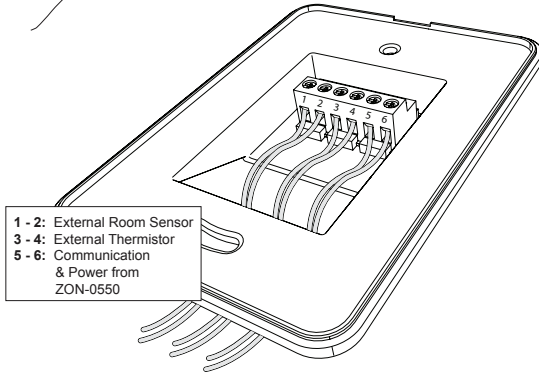
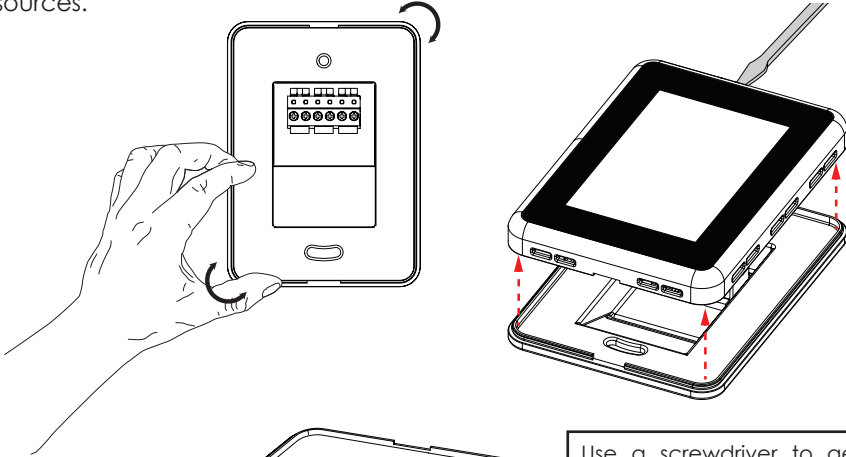

- 1 - 2: External Room Sensor
- 3 - 4: External Thermistor
- 5 - 6: Communication & Power from ZON-0550

Use a screwdriver to gently pop the front cover off from the top of the thermostat, and then remove the front to expose wiring terminals.

Do not use the screwdriver on the bottom of the thermostat. This can cause damage to the THM-0500

EXTERNAL ROOM THERMISTOR

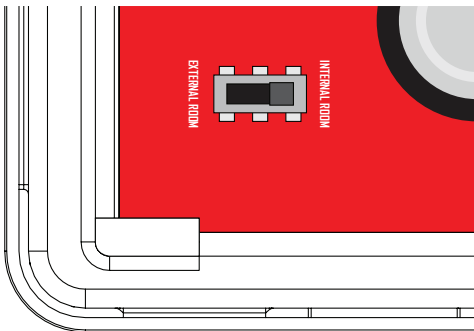

On the THM-0500, the room thermistor switch is located on the bottom left corner of the thermostat.

toggling this switch will allow the user to alternate between the built in room thermistor on the THM-0500, or an external room thermistor connected to pins 1 and 2 on the THM-0500.

WIRING EXAMPLES

THM-0500 using Internal Sensor

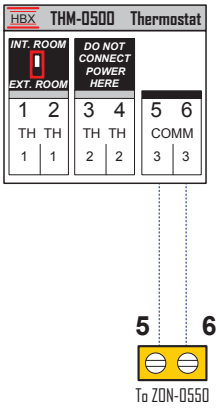

THM-0500 using DHW Sensor as a Digital Aquastat

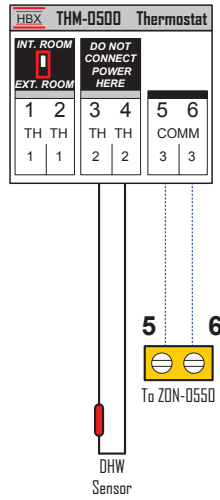

THM-0500 using Room Sensor

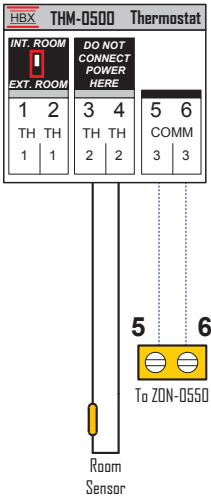

THM-0500 Room averaging using 2 External Room Sensors

To use external room thermistor, toggle dispswitch from Internal to External on THM-0500

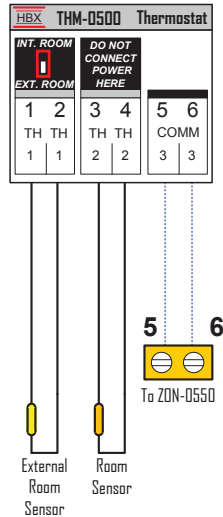

*Sensor input can be used for DHW, Room, Floor, and Outdoor Sensors

THM-0500 using Floor Sensor

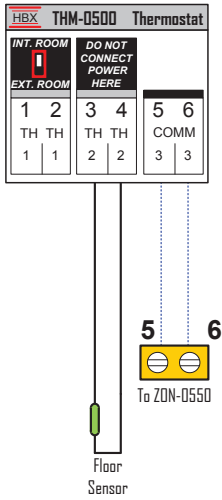

THM-0500 using Outdoor Sensor

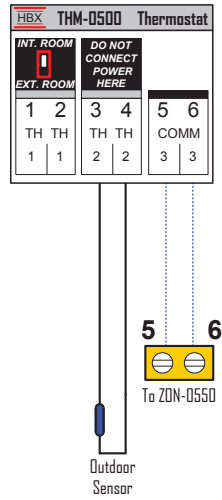

THM-0500 Dual Mode using External Room Sensor and Floor Sensor

To use external room thermistor, toggle dispswitch from Internal to External on THM-0500

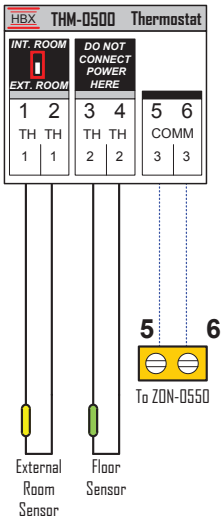

TROUBLESHOOTING GUIDE

ISSUE	POSSIBLE CAUSES & RESOLUTIONS
Blank Screen	<ul style="list-style-type: none">• <i>Check the ZON-0550 power</i>• <i>Check wiring polarity between the THM-0300/THM-0500 and ZON-0550 module.</i>• <i>Ensure zones 1 and 3 damper/4-pipe is set correctly.</i>
Stage 2 won't come on	<ul style="list-style-type: none">• <i>Check stage delay in system setup for proper time.</i>• <i>In special functions ensure you have selected correct thermostat type.</i>
Demand not coming on	<ul style="list-style-type: none">• <i>Demands may take up to 5 minutes to operate due to P.I.D algorithm.</i>• <i>Verify wiring on the ZON-0550 module.</i>• <i>Check priorities settings in zone setup.</i>• <i>Check the changeover settings</i>
Temperature not displaying correct value	<ul style="list-style-type: none">• <i>If it is showing dash lines ensure that the proper thermostat mode is selected in mode setup.</i>• <i>Ensure external sensor(s) is wired correctly.</i>• <i>Make sure the external room dipswitch on the board is in the correct position.</i>
Target changing	<ul style="list-style-type: none">• <i>Check the setback schedule</i>• <i>If you're in auto changeover, then the target can change to either heating target or cooling target based on actual room temperature.</i>

TROUBLESHOOTING GUIDE

ISSUE	POSSIBLE CAUSES & RESOLUTIONS
Thermostat(s) not showing up on ThermoLinx App	<ul style="list-style-type: none">• <i>Verify sync code and password on thermostat is correct when adding devices</i>• <i>Manually check in thermostat(s)</i>• <i>Ensure zone modules are paired</i>• <i>System is not connected to the internet</i>
Thermostat settings not displayed on the ThermoLinx App	<ul style="list-style-type: none">• <i>Contact HBX Technical support for contactor code to unlock advanced settings.</i>

For additional assistance with the THM-0500, please contact our Technical Support Department toll free at:

+1 (855) 410-2341

LIMITED WARRANTY

HBX Controls warrants each of its products to be free from defects in workmanship and materials under normal use and service for a period of 24 months from date of manufacture or 12 months from date of purchase from an HBX Authorized Dealer, if within the above documented period after date of manufacture.

If the product proves to be defective within the applicable warranty period, HBX on its sole discretion will repair or replace said product. Replacement product may be new or refurbished of equivalent or better specifications, relative to the defective product. Replacement product need not be of identical design or model. Any repair or replacement product pursuant to this warranty shall be warranted for not less than 90 days from date of such repair, irrespective of any earlier expiration of original warranty period. When HBX provides replacement, the defective product becomes the property of HBX Controls.

Warranty Service, within the applicable warranty period, may be obtained by contacting your nearest HBX Controls office via the original Authorized Agent and requesting a Return Material Authorization Number (RMA #). Proof of purchase in the form a dated invoice/receipt must be provided to expedite the issuance of a Factory RMA.

After an RMA number has been issued, the defective product must be packaged securely in the original or other suitable shipping package to ensure that it will not be damaged in transit. The RMA number must be visible on the outside of the package and a copy included inside the package. The package must be mailed or otherwise shipped back to HBX with all costs of mailing/shipping/insurance prepaid by the warranty claimant.

Any package/s returned to HBX without an approved and visible RMA number will be rejected and shipped back to purchaser at purchaser's expense. HBX reserves the right, if deemed necessary, to charge a reasonable levy for costs incurred, additional to mailing or shipping costs.

LIMITATION OF WARRANTIES

If the HBX product does not operate as warranted above the purchasers sole remedy shall be, at HBX's option, repair or replacement. The foregoing warranties and remedies are exclusive and in lieu of all other warranties, expressed or implied, either in fact or by operation of law, statutory or otherwise, including warranties of merchantability and fitness for a particular purpose/application. HBX neither assumes nor authorizes any other person to assume for it any other liability in connection with the sale, installation maintenance or use of HBX Controls products.

HBX shall not be liable under this warranty; if its testing and examination discloses that the alleged defect in the product does not exist or was caused by the purchasers or third persons misuse, neglect, improper installation or testing, unauthorized attempts to repair or any other cause beyond the range of intended use, or by accident, fire, lightning or other hazard.

LIMITATION OF LIABILITY

In no event will HBX be liable for any damages, including loss of data, loss of profits, costs of cover or other incidental, consequential or indirect damages arising out of the installation, maintenance, commissioning, performance, failure or interruption of an HBX product, however caused and on any theory of liability. This limitation will apply even if HBX has been advised of the possibility of such damage.

LOCAL LAW

This limited warranty statement gives the purchaser specific legal rights. The purchaser may also have other rights which vary from state to state in the United States, from Province to Province in Canada and from Country to Country elsewhere in the world.

To the extent this Limited Warranty Statement is inconsistent with local law, this statement shall be deemed modified to be consistent with such local law. Under such local law, certain disclaimers and limitations of this statement may not apply to the purchaser. For example, some states in the United States, as well as some governments outside the United States (including Canadian Provinces), may: Preclude the disclaimers and limitations in this statement from limiting the statutory rights of a consumer (e.g. United Kingdom);

Otherwise restrict the ability of a manufacturer to enforce such disclaimers or limitations; or grant the purchaser additional warranty rights which the manufacturer cannot disclaim, or not allow limitations on the duration of implied warranties.

Phone: +1 (403) 720-0029 Fax: +1 (403) 720-0054
Email: info@hbxcontrols.com Web: www.hbxcontrols.com

Toll Free Technical Support: +1 (855) 410 2341

