





AIR TO WATER DC INVERTER HEAT PUMPS WITH EVI TECHNOLOGY. MONOBLOCK CONFIGURATION

Multi-Functions Heat Pumps

DC inverter Air to Water Heat Pumps for Space Heating, Space Cooling, Domestic Hot Water Pre-Heating. Operating Temperatures -25°C To $+45^{\circ}\text{C}$. Water Supply Temperature as high as 140°F (60°C).

**HSS 030, 60, 80
V2LM SERIES**

+1 (888) 686 7652 

<https://hydrosolar.ca/> 

2305 46th Avenue, Lachine (QC) 
Canada H8T 3C9



1	TABLE OF CONTENTS	
2	Introduction	3
2.1	What Is Air To Water Heat Pump?	3
2.1.1	What is a DC Inverter Compressor?	3
2.1.2	What Is EVI (Enhanced Vapor Injection) Technology?	3
2.1.3	Why Air to Water Heat Pumps are becoming so popular?	3
3	Features	4
3.1	Control Protocol	4
3.2	Control Interface & Control Cards	4
3.3	Compressor	4
4	Cooling/Heating Capacity Ratings and Power input requirements	5
4.1	Ratings list	5
4.2	Cooling Performances:	5
4.2.1	HSS030V2LM	5
4.2.2	HSS060V2LM	5
4.2.3	HSS080V2LM	6
4.3	Heating Performances	6
4.3.1	HSS030V2LM	6
4.3.2	HSS060V2LM	6
4.3.3	HSS080V2LM	7
5	DIMENSIONS & WEIGHTS	8
5.1	Heat Pump Dimensions	8
5.2	Shipping Dimensions and Weights	8
6	Items shipped with Heat Pump	9
7	Exploded Pictures	9
7.1	HSS030V2LM	9
7.2	HSS060V2LM	11
7.3	HSS080V2LM	12
8	Control Card and Wiring Diagrams	14
8.1	Terminals Description	15
9	Piping Diagrams	15
9.1	Dual Tank – Three Functions (all year)	15
9.2	Single Tank – Three Functions (all year-except summer)	18
10	Defrost Mode Sequence of Control	21
10.1	Defrost Mode Sequence of Control:	21
11	Installation	21
11.1	Objectives:	21
11.2	Overview:	21



11.3	Installation and Clearances requirements:	22
11.3.1	Minimum Clearance Requirements	22
11.3.2	Good Practices	22
11.3.3	Installation Prerequisites:	22
12	Operation	26
12.1	Standalone mode	26
12.1.1	Main interface	26
12.1.2	Turn on/off	26
12.1.3	Operating Modes (Heating, Cooling, Hot water, Hot water+cooling, Hot water+heat)	26
12.1.4	Outdoor Temperature Reset for HP Supply/Return Temperature	29
12.1.5	TimeZone/CLOCK	30
12.1.6	Default Settings	31
12.2	Hybrid Operating Mode: Heating Cooling Demand by External Sources	31
12.3	Installation of WIFI Adapter	32
12.3.1	Hardware Installation & Connection:	32
12.3.2	Application downloads and setup:	33
12.3.3	Device List Windows:	35
12.3.4	Application usage guide:	36
13	Warranty (limited Residential Warranty)	37
14	Annex "A" – Error Codes List	38
15	Annex "B" – Heat Pumps Troubleshooting Schedule	38
16	Annex "C" – Heat Pumps Controller Menus and Sub-Menus Tree	38
17	Annex "D" – Heat Pumps Performance in Domestic Hot Water Mode	38

2 INTRODUCTION

2.1 WHAT IS AIR TO WATER HEAT PUMP?

Air to Water Heat Pump is a machine that draws heat from one place (called heat source) and reject the drawn heat to another place (called heat sink). Unlike conventional air to air heat pump, where generated thermal energy is used to cool/heat air, Air to Water Heat Pumps use generated thermal energy to cool/heat water or water/glycol fluid mixture. Our air to water heat pumps are equipped with DC inverter Compressor and EVI (Enhanced vapor injection) technology, which allows them to deliver higher temperature fluid in much colder outdoor temperatures when compared to conventional two stages or DC inverter only (without EVI) Heat Pumps.

2.1.1 What is a DC Inverter Compressor?

DC inverter compressors are variable speed compressors powered by direct current inverters. Speed is modulated via an external variable-frequency drive - to control the speed of the compressor. The refrigerant flow rate is changed by the change in the speed of compressor. The turndown ratio depends on the system configuration and manufacturer. It modulates from 15 or 25% up to 100% at full capacity. This means that heat pump operating with a DC inverter compressor can match its capacity to the demand by simply modulating its compressor speed. Unlike conventional one or two stages compressors, Heat Pumps equipped with a DC inverter compressor do not cycle ON and OFF more frequently, they run most of the time at lower speeds.

2.1.2 What Is EVI (Enhanced Vapor Injection) Technology?

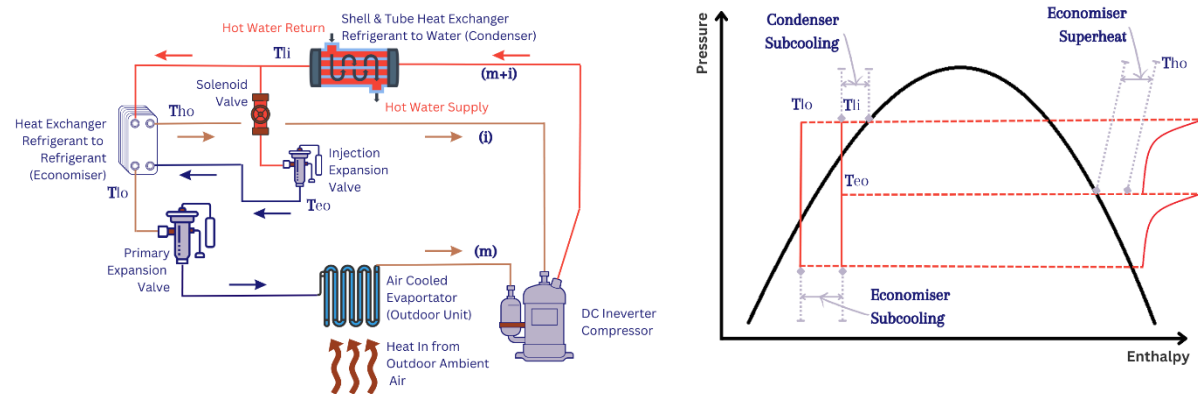

As shown in the above schematic, the liquid out of the condenser is separated into two parts. A smaller part of the liquid, i , is expanded through an additional expansion valve, and then directed (or flows) into a counter-flow plate heat exchanger, HX. The main part of the liquid out of the condenser, m , is then cooled down through the economizer while evaporating and superheating the injection mass flow. This additional plate heat exchanger, more generally called economizer, acts therefore as a sub cooler for the main mass flow m and as an evaporator for the injection mass flow. Superheated vapor is then injected into the intermediate vapor injection port in the scroll compressor.

The additional subcooling increases the evaporator capacity by reducing the temperature of the liquid from T_{LI} to T_{LO} , thus reducing its enthalpy. The additional condenser mass flow, i , increases the heating capacity by the same amount.

Efficiency with vapor injection scroll compressor cycle is higher than that of a conventional single stage scroll delivering the same capacity because the added capacity is achieved with proportionally less power. The injection mass flow created in the subcooling process is compressed only from the higher inter-stage pressure rather than from the lower suction pressure.

The additional Sub-cooling effect of EVI configuration allows heat pump to draw heat from the outdoor at lower outdoor temperatures. That could explain why DC inverter (Non EVI) Heat Pumps operate between -20°C and 45°C (Outdoor BD Temperatures) while DC Inverter EVI Heat Pumps operate between -25°C and 45°C (Outdoor BD Temperatures).

2.1.3 Why Air to Water Heat Pumps are becoming so popular?

Canadian/US Building Codes are becoming more demanding in terms of energy efficiency for both residential and commercial buildings. Canadian Federal Government is aiming to gradually increase the energy efficiency standard for both existing and new constructions by requiring that every new home in Canada be Net Zero Ready by 2025 and completely Net Zero by 2030.

Getting Gradually to the Net Zero Energy will have to make sense, not only from an environmental point of view but from a financial and social point of view too. Even though renewable energies' prices are going down and efficiency is going up, they are still not affordable for a normal middle-class North American Household



when adding the cost of labor to the cost of materials. Also, labor cost increases twofold when retrofitting an existing home with one or a combination of several renewable energy sources (such as solar, geothermal, etc....).

Before the emergence of Air to Water Heat Pumps, Canadian/US homes and business owners who wished to heat/cool their properties with hydronic systems had only two choices: either Conventional Electric/Gas/Propane/Wood boilers which are affordable but extremely environmentally unfriendly or Geothermal Heat Pumps which are extremely expensive and environmentally friendly.

Air to Water Heat Pumps combine affordability and energy efficiency and do make a great sense when comparing budgets for conventional Boiler based scenario, Air to Water Heat Pump Scenario and Geothermal Scenario.

Geothermal Heat Pump, for a regular Canadian/US home, has an annual COP (Coefficient of Performance) of around 3. A similar capacity Air to Water Heat pump has an annual COP of 2.2-2.4 for a much lower. In General, Air to Water Heat pumps are 20-30% less efficient than their geothermal peers but they are 60% cheaper.

3 FEATURES

3.1 CONTROL PROTOCOL

Our air to water heat pumps use Modbus protocol. Modbus is a communication protocol developed by Modicon systems. In simple terms, it is a method used for transmitting information over serial lines between electronic devices. Modbus is an open protocol, meaning that it is free for manufacturers to build into their equipment without having to pay royalties.

It has become a very common protocol used widely by many manufacturers HVAC Equipment. Modbus is typically used to transmit signals from instrumentation and control devices back to a main controller or data gathering system.

Modbus can be easily integrated with BACnet Controller either through BACnet/Modbus Gateways or simply by integrating the Modbus controller with the BACnet Controller (most BACnet controllers' manufacturer have adapted their firmware to read Points Table of Modbus controllers).

3.2 CONTROL INTERFACE & CONTROL CARDS



Control interface is CAREL PGD1000 interface and Heat Pumps Controller are CAREL Controllers with Modbus Protocol.

Compressor variable speed controller is CAREL Model PS2002523D100 (*Input: 200-240Vac, 50/60Hz, 40-57A; AC output: 0-240V, 25-30A, DC output: 385V, 1500W Software: Class B.*).

Condenser Fan variable Speed Controller is CAREL PSALB00000 (*240-400Vdc, max 1.5Adc*).

3.3 COMPRESSOR

Compressors are Panasonic EVI DC Inverter Twin Rotary Compressors. Panasonic uses high efficiency pump and environmentally friendly refrigerant, to achieve energy efficient and reliable rotary compressor designs.

Panasonic has the smallest size variable speed rotary compressor in the industry. Panasonic rotary compressor has a good reputation with clients all over the world and are commonly used for room air conditioning and refrigeration.



4 COOLING/HEATING CAPACITY RATINGS AND POWER INPUT REQUIREMENTS

4.1 RATINGS LIST

Model No.	Power Supply	Electrical Power Input (KW)				Running Current (A) Max Load	Noise Level (dBA)
		Cooling Mode @ Ambient Dry Bulb: 43°C (109.4°F), Water inlet 20°C (68°F)	Heating Mode @ Ambient Dry Bulb: -20°C (-4°F), Water inlet 50°C (122°F)	Cooling Load Max	Heating Load Max		
HSS030V2LM	220-240VAC/1Ph/60Hz	2.52	2.62	3.43	3.52	16.23	52
HSS060V2LM	220-240VAC/1Ph/60Hz	4.12	5.40	6.11	6.52	29.67	55
HSS080V2LM	220-240VAC/1Ph/60Hz	6.32	5.98	8.34	8.36	38.05	58

Model No.	Water Flow (US GPM) – Nominal - Maximum	Water Pressure Drop		Liquid Pipe Connection	Refrigerant Type	Refrigerant Charge (OZ)	Design Refrigerant Pressure (PSI)		MOP (A)	MCA (A)	Maximum Inlet Water Temperature (°C) / (°F)
		kPa	Feet				Low	High			
HSS030V2LM	6.07-8.2	16.8-27	5.62-9.03	Ø1" - FNPT	R410A	56.4	305	609	39.56	29.41	55°C / 131°F
HSS060V2LM	11.35-13.0	20.8-32	6.96-10.7	Ø1" - FNPT	R410A	105.8	305	609	65.84	48.16	55°C / 131°F
HSS080V2LM	15.14-19.2	25.5-38	8.53-12.71	Ø1¼" - FNPT	R410A	134.6	305	609	100.8	58.72	55°C / 131°F

Remarks:

HSS030V2LM is equipped with one Twin Rotary DC Inverter compressor: Panasonic - H240D5KZAAJ2.
HSS060V2LM is equipped with one Twin Rotary DC Inverter compressor: Panasonic - H420D5VZAAJ2.
HSS080V2LM is equipped with one Twin Rotary DC Inverter compressor: Panasonic - H550D5VZAAJ2.

4.2 COOLING PERFORMANCES:

4.2.1 HSS030V2LM

HSS030V2LM					
Outdoor Air DB Temperature (°C)	Outdoor Air DB Temperature (°F)	Supply Water Temperature 44.6°F (7°C) / Return Water Temperature 53.6°F (12°C)			
		Cooling Capacity (KW)	Cooling Capacity (BTU/HR)	Power Consumption (KW)	COP
23	73.4	14.31	48,823	2.84	5.04
26	78.8	12.64	43,126	2.93	4.31
29	84.2	11.37	38,793	2.96	3.84
32	89.6	9.62	32,822	3.07	3.13
35	95	8.23	28,080	3.15	2.61

4.2.2 HSS060V2LM

HSS060V2LM					
Outdoor Air DB Temperature (°C)	Outdoor Air DB Temperature (°F)	Supply Water Temperature 44.6°F (7°C) / Return Water Temperature 53.6°F (12°C)			
		Cooling Capacity (KW)	Cooling Capacity (BTU/HR)	Power Consumption (KW)	COP
23	73.4	27.92	95,258	5.56	5.02
26	78.8	24.68	84,204	5.68	4.35
29	84.2	22.17	75,640	5.75	3.86
32	89.6	18.73	63,904	5.81	3.22
35	95	15.35	52,372	5.92	2.59



4.2.3 HSS080V2LM

HSS080V2LM					
Outdoor Air DB Temperature (°C)	Outdoor Air DB Temperature (°F)	Supply Water Temperature 44.6°F (7°C) / Return Water Temperature 53.6°F (12°C)			
		Cooling Capacity (KW)	Cooling Capacity (BTU/HR)	Power Consumption (KW)	COP
23	73.4	37.82	129,035	7.53	5.02
26	78.8	32.93	112,351	7.61	4.33
29	84.2	29.56	100,853	7.74	3.82
32	89.6	24.89	84,920	7.82	3.18
35	95	20.63	70,386	7.97	2.59

4.3 HEATING PERFORMANCES

4.3.1 HSS030V2LM

Outdoor Air DB Temperature (°C)	Outdoor Air DB Temperature (°F)	Supply Water Temperature 95°F (35°C) / Return Water Temperature 86°F (30°C)				Supply Water Temperature 113°F (45°C) / Return Water Temperature 104°F (40°C)				Supply Water Temperature 131°F (55°C) / Return Water Temperature 122°F (50°C)			
		Heating Capacity (KW)	Heating Capacity (BTU/HR)	Power Input (KW)	COP	Heating Capacity (KW)	Heating Capacity (BTU/HR)	Power Input (KW)	COP	Heating Capacity (KW)	Heating Capacity (BTU/HR)	Power Input (KW)	COP
-25	-13	3.72	12,692	2.06	1.81	3.69	12,590	2.33	1.58	3.57	12,181	2.61	1.37
-20	-4	4.09	13,955	1.87	2.19	4.57	15,592	2.43	1.88	4.55	15,524	2.79	1.63
-15	5	5.79	19,755	2.28	2.54	5.77	19,687	2.68	2.15	5.64	19,243	3.03	1.86
-7	19.4	6.92	23,610	2.16	3.20	6.87	23,440	2.51	2.74	6.75	23,030	2.93	2.30
2	35.6	7.68	26,203	2.32	3.31	7.53	25,691	2.57	2.93	7.38	25,180	2.87	2.57
7	44.6	10.67	36,404	3.17	3.37	10.52	35,893	3.25	3.24	9.78	33,368	3.54	2.76
12	53.6	10.75	36,677	2.36	4.56	10.63	36,268	2.66	4.00	10.25	34,971	2.94	3.49
20	68	10.86	37,053	1.93	5.63	10.68	36,439	2.23	4.79	10.59	36,131	2.59	4.09
23	73.4	10.76	36,711	1.91	5.63	10.72	36,575	2.17	4.94	10.63	36,268	2.53	4.20
26	78.8	10.82	36,916	1.86	5.82	10.76	36,711	2.06	5.22	10.67	36,404	2.49	4.29
29	84.2	10.78	36,780	1.56	6.91	10.75	36,677	1.92	5.60	10.71	36,541	2.46	4.35
32	89.6	10.81	36,882	1.49	7.26	10.77	36,746	1.81	5.95	10.78	36,780	2.43	4.44
35	95	10.92	37,257	1.43	7.64	10.75	36,677	1.72	6.25	10.72	36,575	2.37	4.52

4.3.2 HSS060V2LM

Outdoor Air DB Temperature (°C)	Outdoor Air DB Temperature (°F)	Supply Water Temperature 95°F (35°C) / Return Water Temperature 86°F (30°C)				Supply Water Temperature 113°F (45°C) / Return Water Temperature 104°F (40°C)				Supply Water Temperature 131°F (55°C) / Return Water Temperature 122°F (50°C)			
		Heating Capacity (KW)	Heating Capacity (BTU/HR)	Power Input (KW)	COP	Heating Capacity (KW)	Heating Capacity (BTU/HR)	Power Input (KW)	COP	Heating Capacity (KW)	Heating Capacity (BTU/HR)	Power Input (KW)	COP
-25	-13	8.92	30,434	5.02	1.78	8.76	29,888	5.49	1.60	8.05	27,465	5.82	1.38
-20	-4	11.17	38,110	5.07	2.20	10.03	34,221	5.55	1.81	10.09	34,426	6.08	1.66
-15	5	12.08	41,215	4.62	2.61	11.6	39,577	5.16	2.25	11.22	38,281	5.94	1.89
-7	19.4	13.89	47,390	4.48	3.10	13.62	46,469	4.90	2.78	13.18	44,968	5.64	2.34
2	35.6	14.69	50,120	4.42	3.32	14.42	49,199	5.04	2.86	14.12	48,175	5.82	2.43
7	44.6	16.82	57,387	4.38	3.84	16.86	57,523	5.13	3.29	16.72	57,046	5.87	2.85
12	53.6	18.5	63,119	4.27	4.33	17.78	60,662	5.07	3.51	17.37	59,263	5.46	3.18
20	68	20.66	70,488	3.65	5.66	19.35	66,019	4.12	4.70	19.15	65,336	5.02	3.81
23	73.4	21.53	73,457	3.47	6.20	19.87	67,793	4.08	4.87	19.62	66,940	4.95	3.96
26	78.8	22.73	77,551	3.45	6.59	20.67	70,522	3.96	5.22	20.32	69,328	4.86	4.18
29	84.2	23.35	79,666	3.37	6.93	21.89	74,685	3.76	5.82	21.26	72,535	4.78	4.45
32	89.6	24.12	82,293	3.34	7.22	22.86	77,994	3.67	6.23	20.35	69,431	4.51	4.51
35	95	24.36	83,112	3.25	7.50	23.35	79,666	3.54	6.60	21.56	73,559	4.36	4.94



4.3.3 HSS080V2LM

Outdoor Air DB Temperature (°C)	Outdoor Air DB Temperature (°F)	Supply Water Temperature 95°F (35°C) / Return Water Temperature 86°F (30°C)				Supply Water Temperature 113°F (45°C) / Return Water Temperature 104°F (40°C)				Supply Water Temperature 131°F (55°C) / Return Water Temperature 122°F (50°C)			
		Heating Capacity (KW)	Heating Capacity (BTU/HR)	Power Input (KW)	COP	Heating Capacity (KW)	Heating Capacity (BTU/HR)	Power Input (KW)	COP	Heating Capacity (KW)	Heating Capacity (BTU/HR)	Power Input (KW)	COP
-25	-13	11.87	40,499	6.85	1.73	11.68	39,850	7.33	1.59	10.74	36,643	7.73	1.39
-20	-4	14.89	50,802	7.16	2.08	14.06	47,970	7.41	1.90	13.34	45,514	8.1	1.65
-15	5	16.1	54,930	6.66	2.42	15.46	52,747	6.88	2.25	15.13	51,621	7.71	1.96
-7	19.4	18.53	63,221	6.21	2.98	18.16	61,959	6.54	2.78	17.58	59,980	7.52	2.34
2	35.6	20.92	71,375	6.32	3.31	20.56	70,147	6.72	3.06	20.16	68,782	7.74	2.60
7	44.6	24.29	82,873	7.07	3.44	24.03	81,986	7.26	3.31	23.62	80,587	7.82	3.02
12	53.6	26.73	91,198	6.63	4.03	26.31	89,765	6.75	3.90	25.46	86,865	7.28	3.50
20	68	28.21	96,247	6.26	4.51	28.42	96,964	6.45	4.41	28.16	96,077	6.75	4.17
23	73.4	29.38	100,239	6.14	4.79	27.95	95,360	6.43	4.35	27.35	93,313	6.56	4.17
26	78.8	30.15	102,866	6.12	4.93	29.23	99,727	6.33	4.62	28.65	97,749	6.47	4.43
29	84.2	31.25	106,619	6.07	5.15	30.15	102,866	6.14	4.91	29.25	99,796	6.28	4.66
32	89.6	31.56	107,677	5.86	5.39	29.84	101,809	6.11	4.88	28.75	98,090	6.19	4.64
35	95	31.35	106,960	5.79	5.41	29.56	100,853	6.02	4.91	28.23	96,316	6.11	4.62

5 DIMENSIONS & WEIGHTS

5.1 HEAT PUMP DIMENSIONS

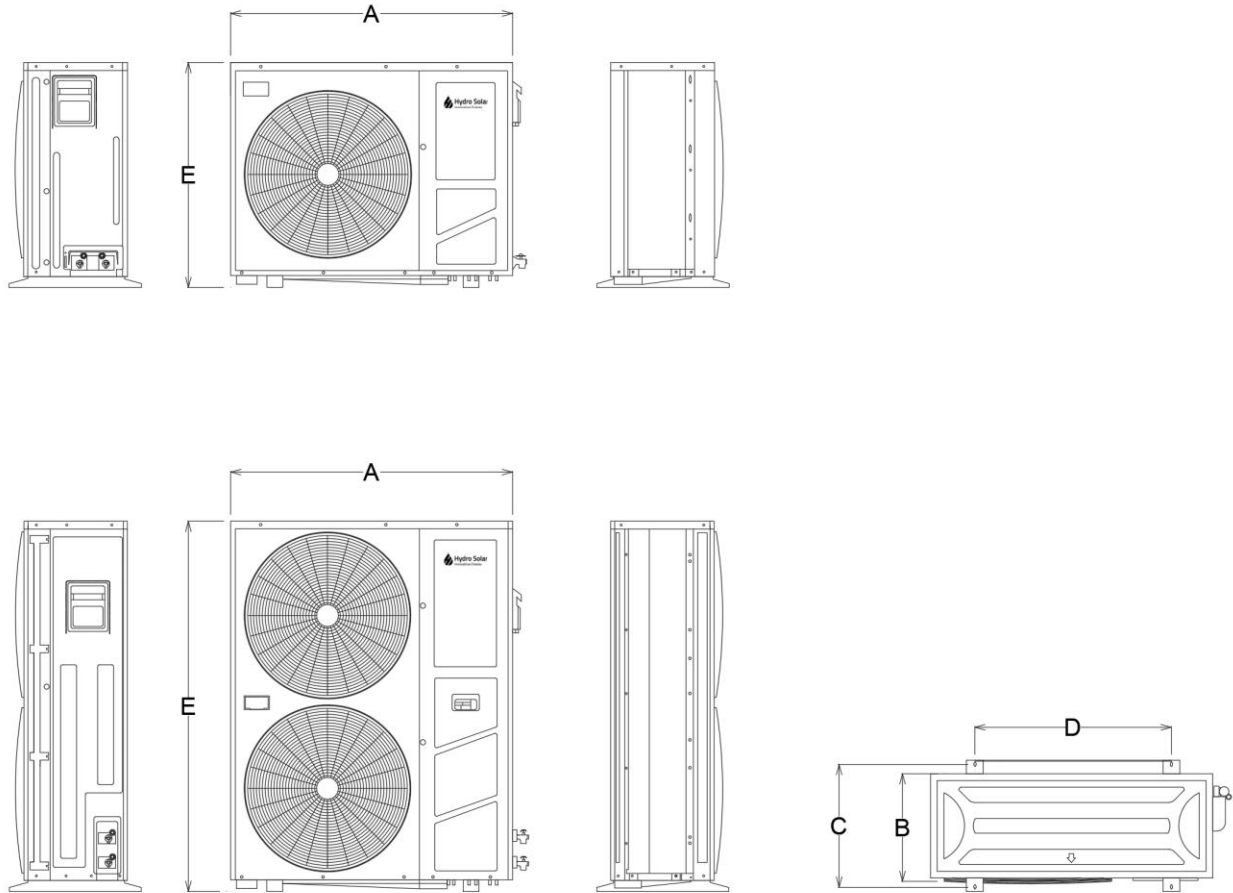

Dimension	HSS030V2LM-mm (inches)	HSS060V2LM -mm (inches)	HSS080V2LM -mm (inches)
A	1030 (40.55)	1030 (40.55)	1030 (40.55)
B	392 (15.43)	392 (15.43)	392 (15.43)
C	448 (17.63)	448 (17.63)	448 (17.63)
D	718 (28.26)	718 (28.26)	718 (28.26)
E	820 (32.28)	1350 (53.15)	1350 (53.15)

5.2 SHIPPING DIMENSIONS AND WEIGHTS

Model Number	Unit Dimensions	Unit Weight
HSS030V2LM	44.5"x19"x36"	200 Lb
HSS060V2LM	44.5"x19"x58"	300 Lb
HSS080V2LM	44.5"x19"x58"	350 Lb

6 ITEMS SHIPPED WITH HEAT PUMP

The following items are shipped with the heat pump:

- Heat Pump (including all sensors, CAREL Controller, etc....).
- WIFI Adapter (with Free to download WIFI app).

7 EXPLODED PICTURES

7.1 HSS030V2LM

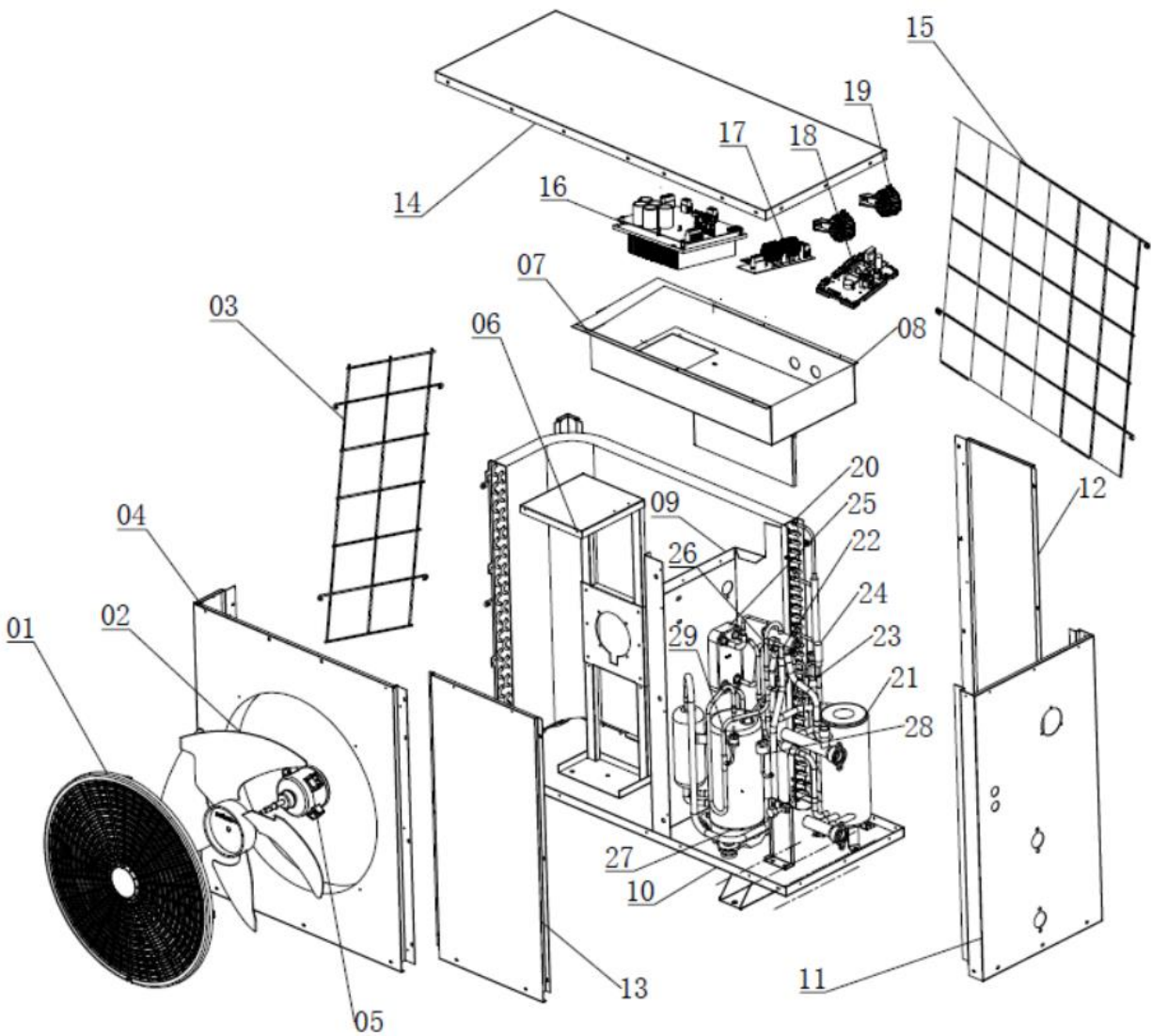



Number ID	Description
01	Front Panel
02	Fan Blade
03	Left Guard Net
04	Front Air Outlet Panel Assembly
05	DC motor
06	Motor Bracket Assembly
07	Driver Electrical Box
08	Main Control Panel Electrical Box
09	Middle Diaphragm Assembly
10	Chassis Assembly
11	Right Side Panel
12	Rear Side Panel
13	Front Side Panel
14	Top Cover Plate
15	Rear Guard Net

Number ID	Description
16	DC Inverter Board
17	DC Inverter Filter Plate
18	Carel Main electrical control board
19	Inductor
20	Air Cooled Condenser Assembly
21	Refrigerant to Water Shell & Tube Heat Exchanger
22	Four Way Valve
23	Filter
24	Carel Electronic Expansion Valve (EEV)
25	Economizer
26	Auxiliary EEV
27	Panasonic Compressor
28	Low Pressure Switch
29	High Pressure Switch

7.2 HSS060V2LM

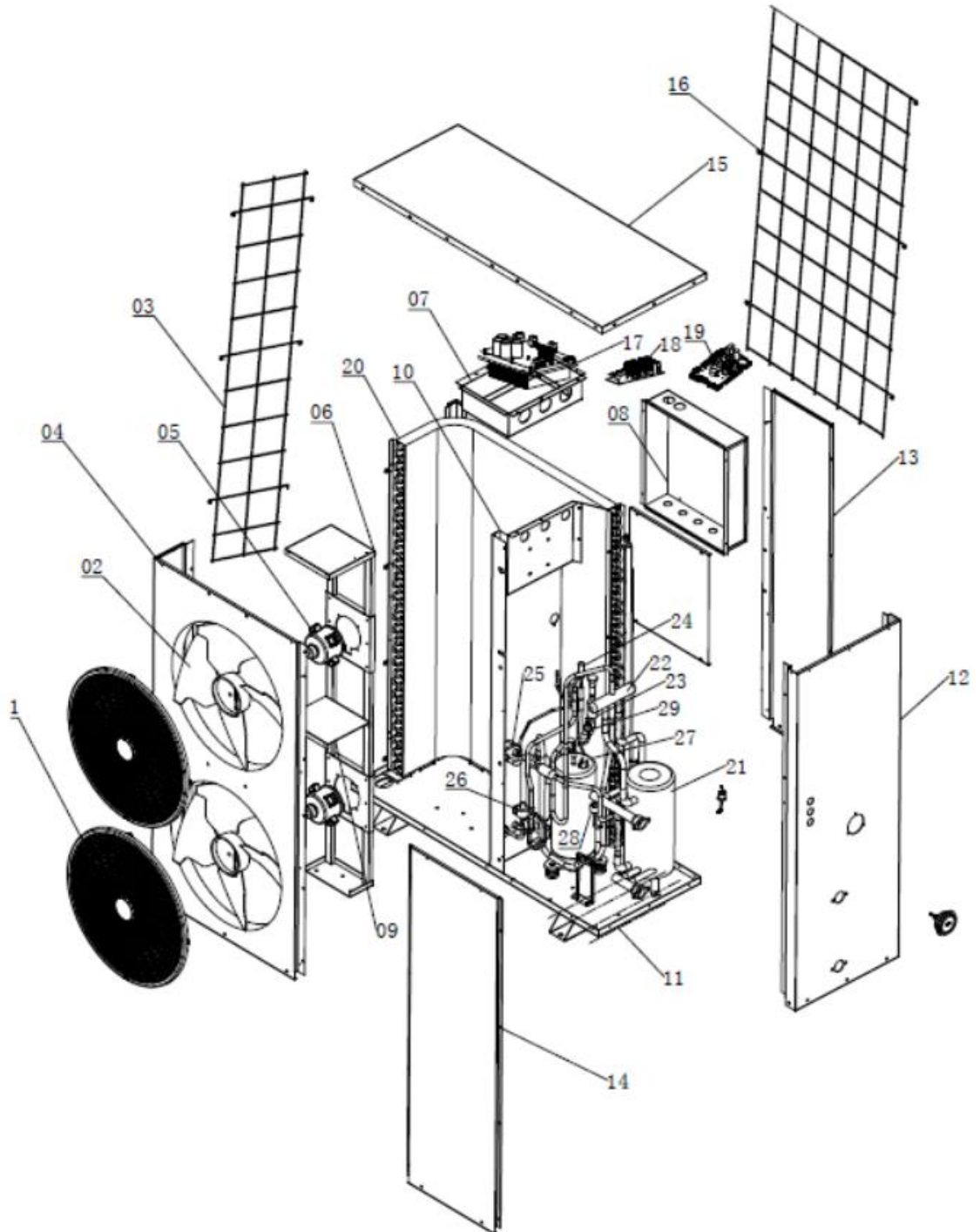



Number ID	Description
01	Front Panel
02	Fan Blade
03	Left Guard Net
04	Front Air Outlet Panel Assembly
05	DC motor
06	Motor Bracket Assembly
07	Driver Electrical Box
08	Main Control Panel Electrical Box
09	Middle Diaphragm Assembly
10	Chassis Assembly
11	Right Side Panel
12	Rear Side Panel
13	Front Side Panel
14	Top Cover Plate
15	Rear Guard Net

Number ID	Description
16	DC Inverter Board
17	DC Inverter Filter Plate
18	Carel Main electrical control board
19	Inductor
20	Air Cooled Condenser Assembly
21	Refrigerant to Water Shell & Tube Heat Exchanger
22	Four Way Valve
23	Filter
24	Carel Electronic Expansion Valve (EEV)
25	Economizer
26	Auxiliary EEV
27	Panasonic Compressor
28	Low Pressure Switch
29	High Pressure Switch

7.3 HSS080V2LM

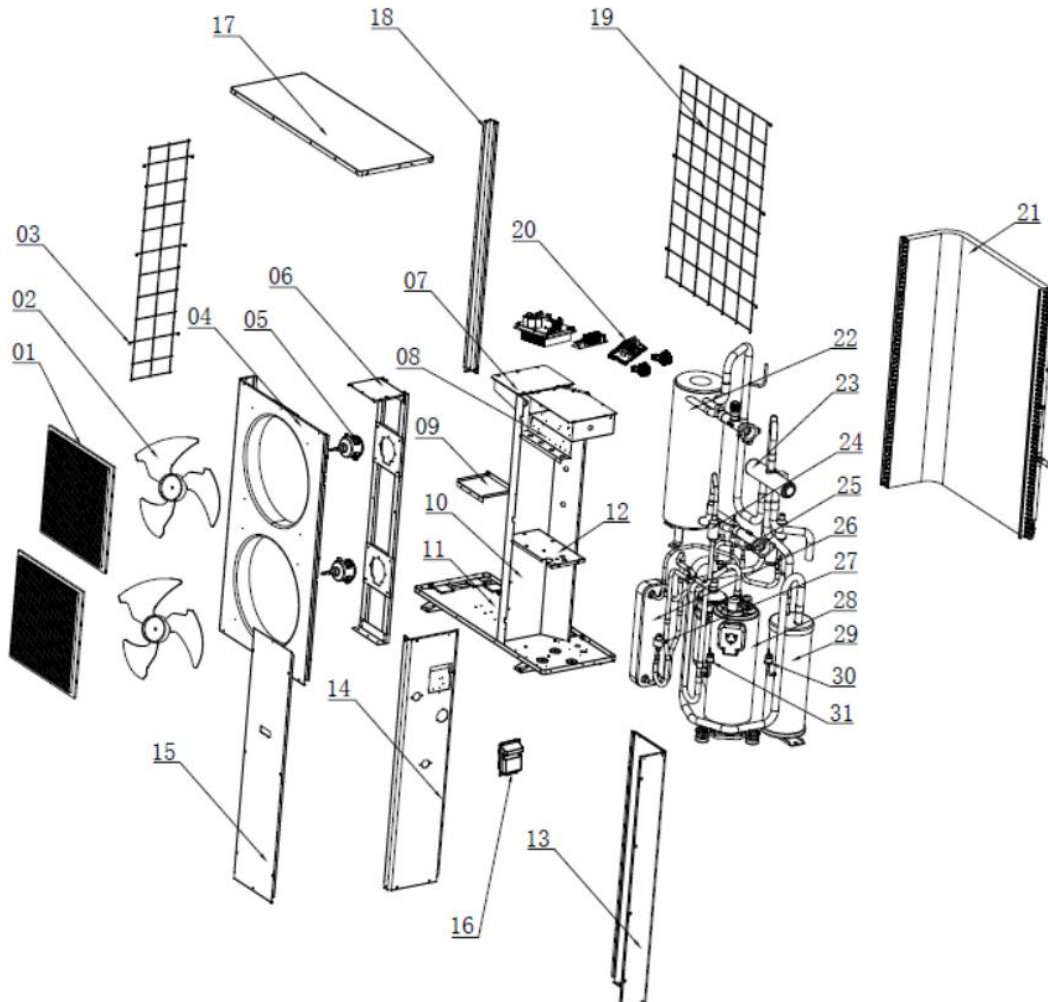



Number ID	Description
01	Front Panel
02	Fan Blade
03	Left Guard Net
04	Front Air Outlet Panel Assembly
05	DC motor
06	Motor Bracket Assembly
07	Driver Electrical Box
08	Main Control Panel Electrical Box
09	Intermediate Fixing Plate
10	Middle Diaphragm Assembly
11	Chassis Assembly
12	Middle Bottom Support Plate
13	Rear Side Panel
14	Front Right Side Panel
15	Front Access Panel
16	Handle

Number ID	Description
17	Top Cover Plate
18	Rear Column
19	Rear Guard Net
20	Carel Main electrical control board
21	Air Cooled Condenser Assembly
22	Refrigerant to Water Shell & Tube Heat Exchanger
23	Four Way Valve
24	Filter
25	Carel Electronic Expansion Valve (EEV)
26	Economizer
27	Auxiliary EEV
28	Panasonic Compressor
29	Gas Liquid Separator
30	Low Pressure Switch
31	High Pressure Switch



8 CONTROL CARD AND WIRING DIAGRAMS

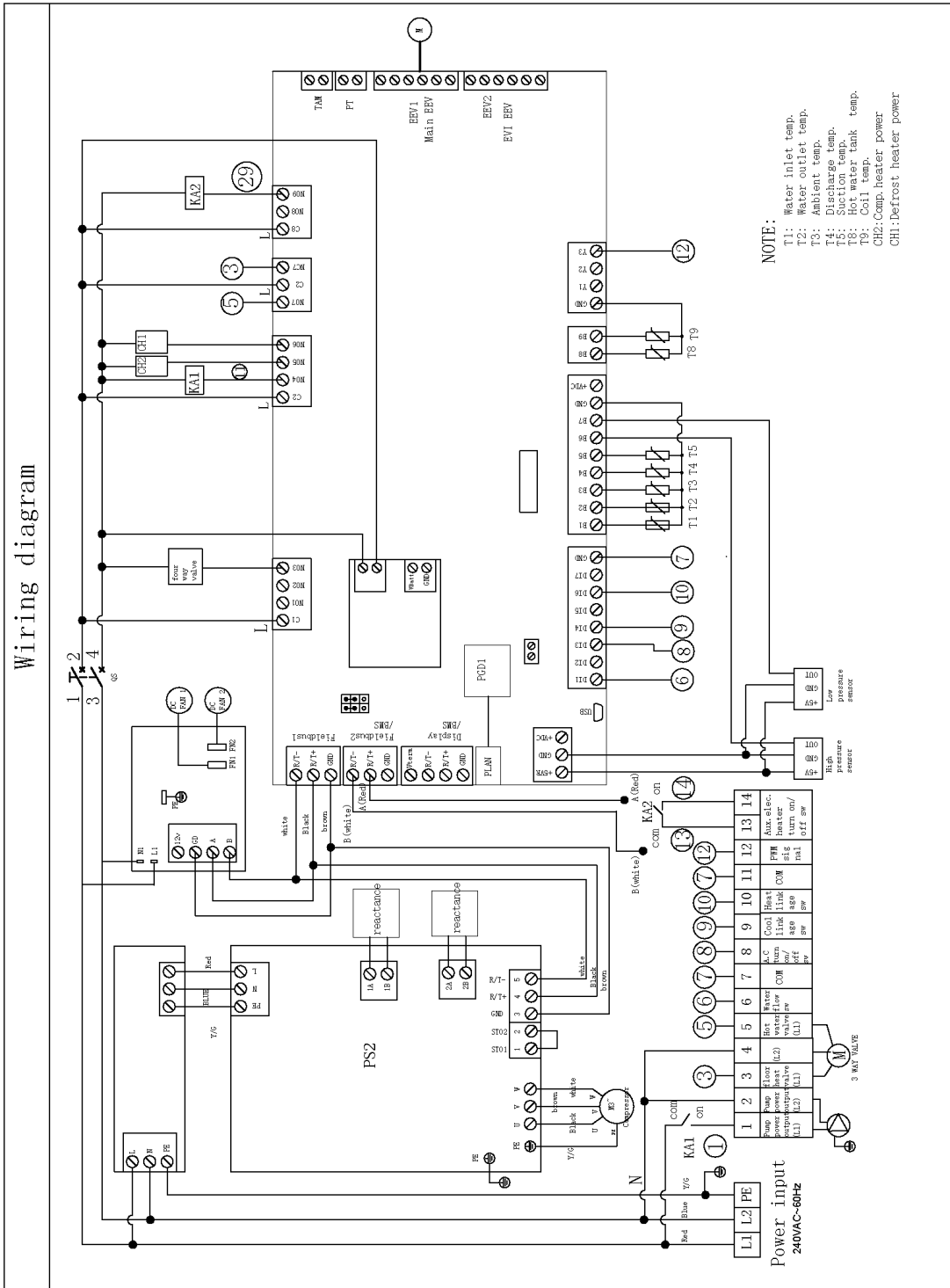



8.1 TERMINALS DESCRIPTION

1	2	3	4	5	6	7	8	9	10	11	12	13	14
PUMP POWER OUTPUT (L1)	PUMP POWER OUTPUT (L2)	Floor heat valve (L1)	(L2)	Hot water valve (L1)	Water flow sw	COM	A. C turn on/off sw	Cool link age sw	Heat link age sw	COM	PWM signal	Aux. elec. heater turn on/off sw	

Terminal	Function	Type
1-2: PUMP POWER OUTPUT	Power Supply for Heat Pump Circulation Pump (Pump not included)	220-230V/1Ph/60Hz
3-4-5: THREE WAY VALVE POWER OUTPUT	Floating Type 3 Way Valve. Switches between DHW tank and Space Heating/Cooling Tank	220-230V/1Ph/60Hz
6: WATER FLOW SWITCH	Water flow switch (in the indoor unit) connection port (6-7). Must be wired to outdoor	Dry Contact (can be configured NO or NC from Carel Controller)
7: COM	Common	
8: ON/OFF SWITCH	Switches Heat Pump ON or OFF. Factory Jumper between 7 (COM) and 8	Dry Contact (can be configured NO or NC from Carel Controller)
9: COOLING LINKAGE SWITCH	Changes Heat Pump Operating Mode to Cooling. Heat Pump must be turned off before changing operating mode.	Dry Contact (can be configured NO or NC from Carel Controller)
10: HEATING LINKAGE SWITCH	Changes Heat Pump Operating Mode to Heating. Heat Pump must be turned off before changing operating mode.	Dry Contact (can be configured NO or NC from Carel Controller)
11: COM	Common	
12: CIRCULATION PUMP SPEED CONTROL	Modulates the speed of circulation Pump (optional)	PWM
13-14: AUXILIARY HEATER CONTROL SWITCH	Enables the operation of the backup heater	Dry Contact (NO)

Power and control wiring shall be done by qualified personnel. Please check your Federal, Provincial and any local regulation requirements related to the purchase/installation and operation of this equipment. It is the buyer responsibility to comply with such regulatory requirements.

9 PIPING DIAGRAMS

9.1 DUAL TANK – THREE FUNCTIONS (ALL YEAR)

In this configuration, a tank is dedicated for the DHW heating and another one is dedicated for either space heating or space cooling. This allows each tank to be maintained at a separate temperature.

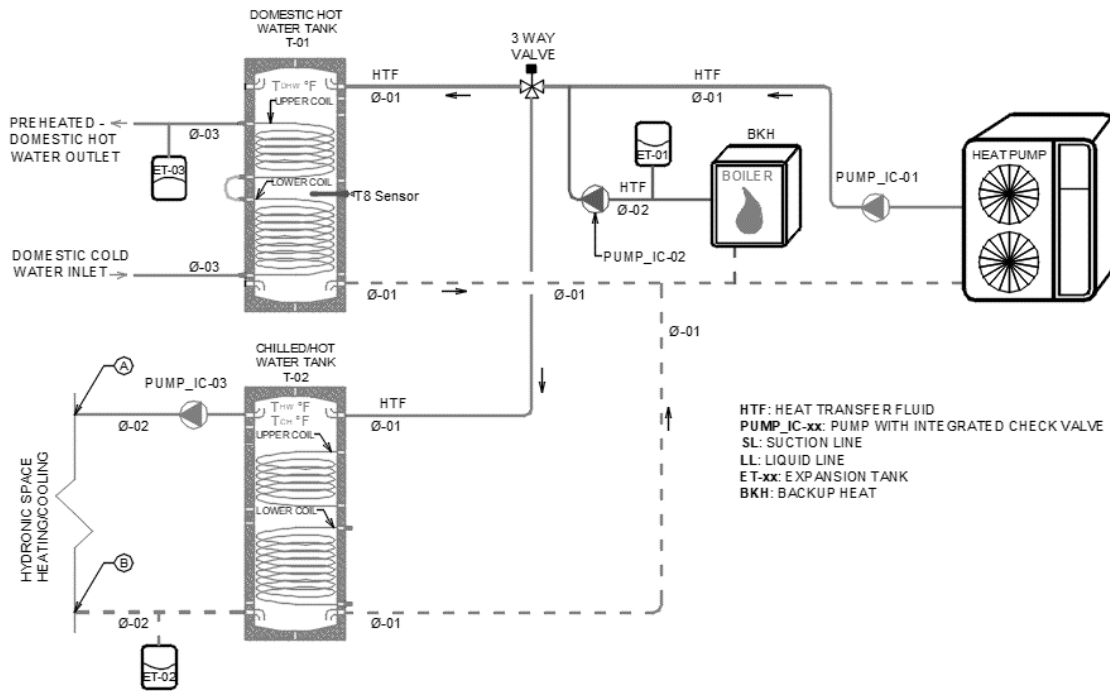



A hydraulic separator is used when the space cooling is done, via fan coil units (FCU) or an air handling units (AHU), with hydronic coils designed to dehumidify with chilled supply temperature of 7°C (44.6°F). The hydraulic separator allows water at 7°C (44.6°F) to be directly supplied to FCU and/or AHU and avoid thermal stratification from the tank which might increase chilled water supply temperatures above 7°C (44.6°F).

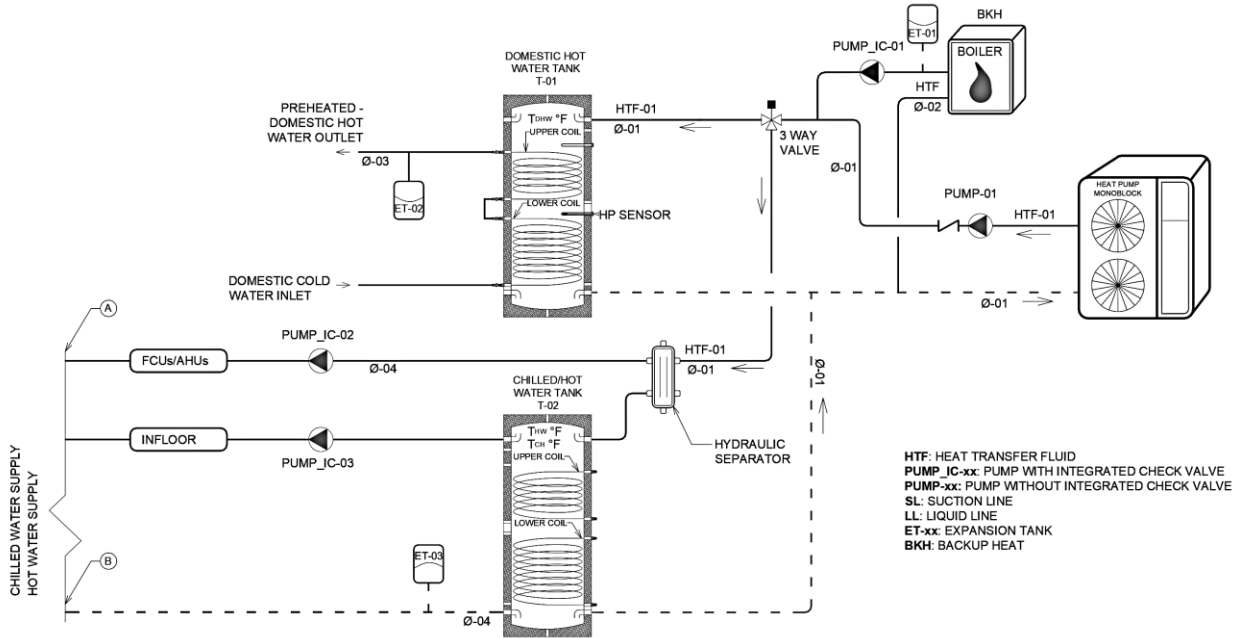



Sample Wiring diagram with Thermolec Boiler as a backup heater

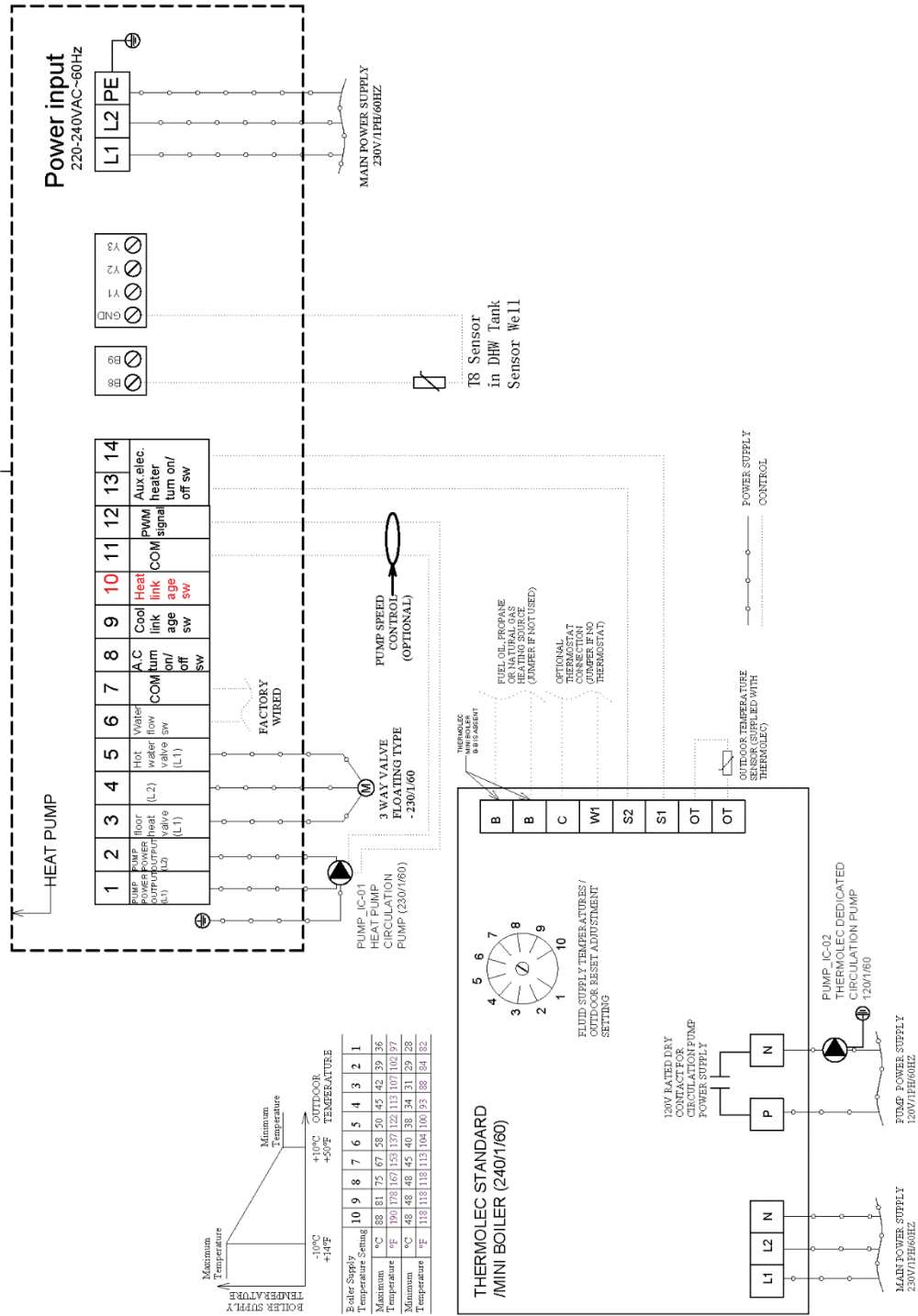



9.2 SINGLE TANK – THREE FUNCTIONS (ALL YEAR-EXCEPT SUMMER)

In this configuration, we only use one tank, either in cooling mode or heating mode. When Heat Pump is in heating mode, indirect coil can be used for pre-heating domestic hot water. To Maximize the energy efficiency of the system and prevent DHW from being cooled when heat pump is in cooling mode, a three-way valve shall be installed to by-pass the indirect coil when in cooling mode.

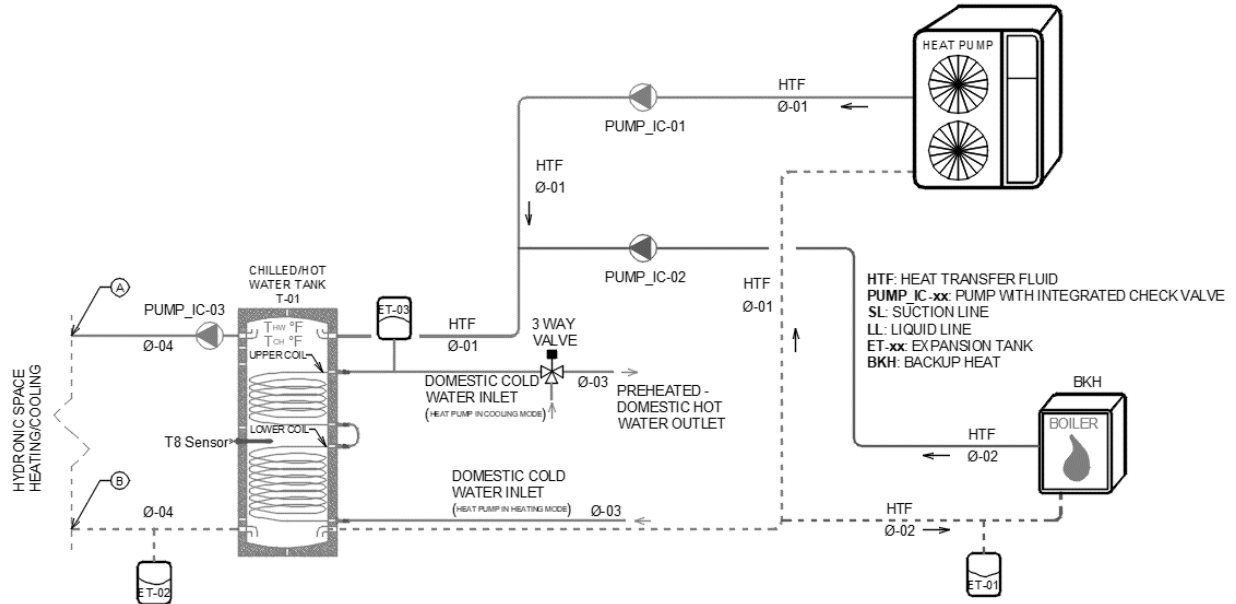

Or backup heat can be connected to the indirect coil

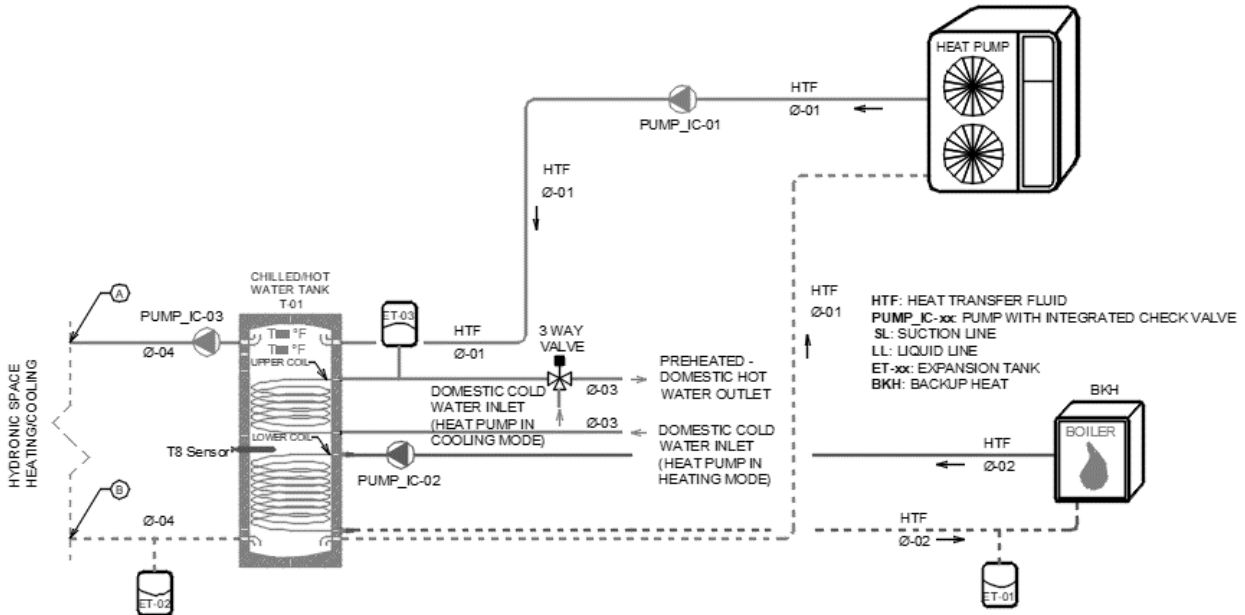



A hydraulic separator is used when the space cooling is done, via fan coil units (FCU) or an air handling units (AHU), with hydronic coils designed to dehumidify with chilled supply temperature of 7°C (44.6°F). The hydraulic separator allows water at 7°C (44.6°F) to be directly supplied to FCU and/or AHU and avoid thermal stratification from the tank which might increase chilled water supply temperatures above 7°C (44.6°F).

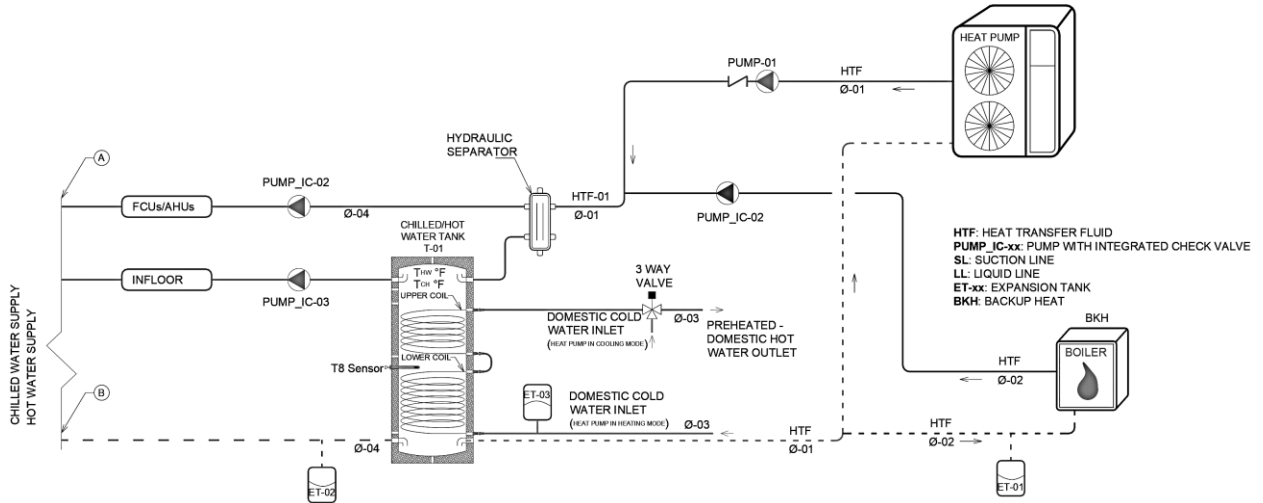

Sample Wiring diagram with Thermolec Boiler as a backup heater

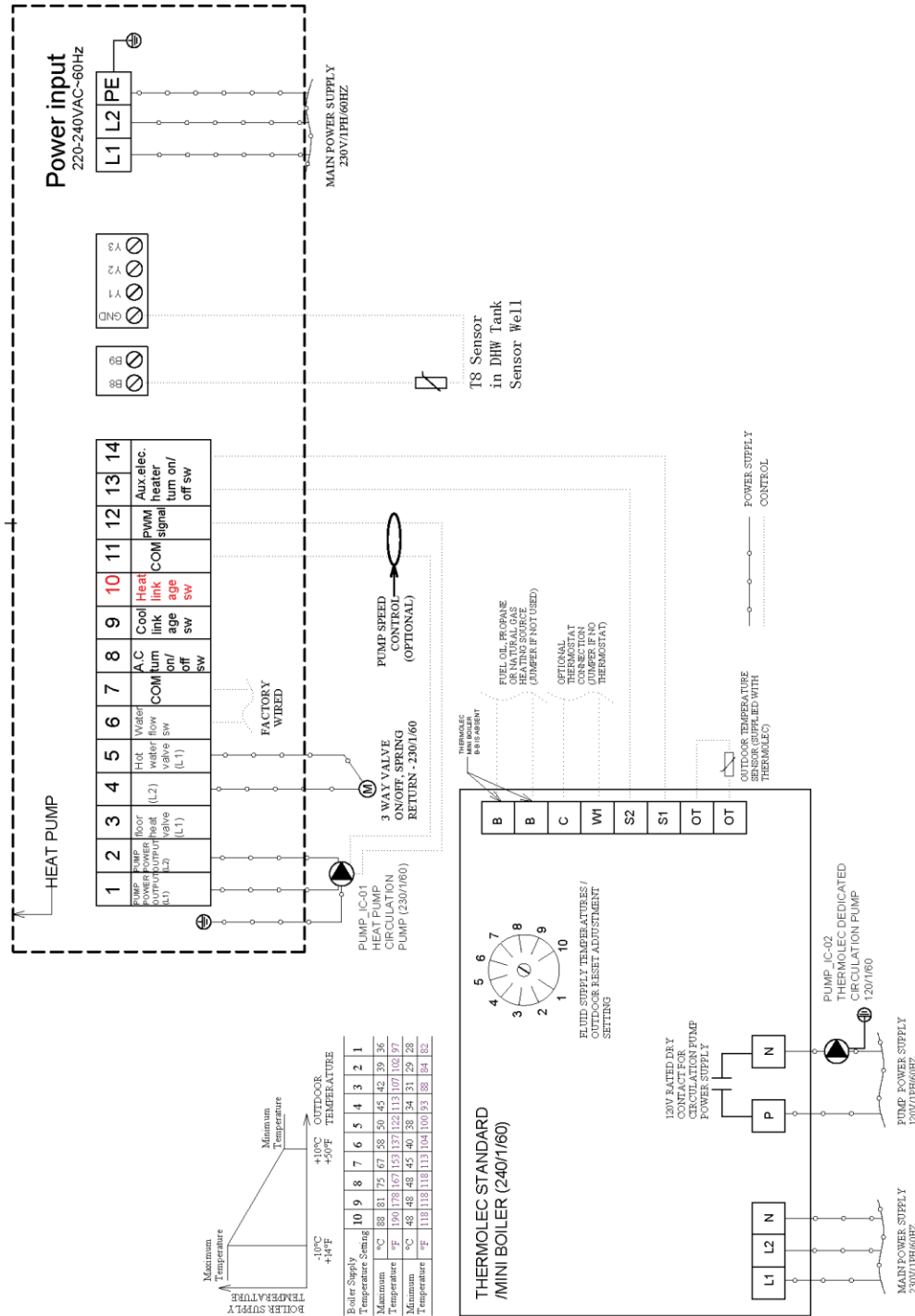



10 DEFROST MODE SEQUENCE OF CONTROL

When the air-cooled unit is in heating mode, the outdoor coil is the evaporator (it draws heat to the outside to inside). For outdoor temperatures below freezing, humidity present in the ambient air will freeze on the outdoor coil, which lower the heat pump thermal efficiency. To melt the ice accumulated on the outside coil we switch the heat pump into cooling mode. Heat is drawn for the inside (*usually from the thermal storage tank*) and used for melting the accumulated ice on the outdoor coil.

10.1 DEFROST MODE SEQUENCE OF CONTROL:

Defrost mode is enabled when all the following conditions are met:

- (1) Time between two defrosting cycles \geq defrosting interval, unit: min, default value: 45 min;
- (2) Ambient temperature \leq defrosting ambient temperature, lasting for 2s, default value is 20°C (this condition is ignored when there is ambient temperature sensor error);
- (3) Ambient temperature - evaporating temperature \geq defrosting temperature difference, lasting for 2min, the default value is 5°C; this condition is ignored when there is ambient temperature sensor error.
- (4) Evaporating temperature \leq defrosting set point, lasting for 2s, default value is -1°C;

Defrost mode is switched off when any of the following conditions is met:

- (1) Defrosting time \geq maximum defrosting time, the default value is 8 min;
- (2) Condensation/coil temperature \geq the setting point of exiting defrosting, default value is 15°C;
- (3) Power is off.

11 INSTALLATION

11.1 OBJECTIVES:

This Installation Paragraph is targeted towards helping understand the equipment as well as assisting in installation for individuals licensed in their respective fields (electricians, plumbers, and HVAC contractors, etc.).

It is a guide that helps determine good practice rules and may include information that is not applicable for a given application and usage of the equipment. These parameters are subject to change without prior notice and the person responsible for the installation should contact Hydro Solar inc. or any certified service and installation contractors. In the case there are any issues with the equipment which was installed without the use of a certified design, or the equipment is allowed to operate outside of its rated range; equipment failure and damage is possible.

11.2 OVERVIEW:

This section will outline a basic common overview of what is required by the installer for the installation:

- *The equipment and all auxiliary equipment are thoroughly inspected for damage and proper functioning prior to being commissioned.*
- *Proper tools, fasteners, brackets, and all other components are being used in the installation.*
- *There is a project plan that ensures all lines, pipes and connections are appropriately sized and all maximum and minimum distances are respected. It is important to know the limitations of the equipment prior to installing any components.*
- *All components are properly fastened and secured to appropriate structures, buildings or mounting systems.*
- *All hydraulic, electrical, and refrigerant lines are properly terminated, affixed, and are not leaking.*
- *All components are protected by over-current protection devices, pressure relief valves and other safety measures.*
- *Once all equipment is operating then warranty information card is filled out and sent to Aqua Solanor Inc. (Owner of Hydro Solar Innovative Energy).*



11.3 INSTALLATION AND CLEARANCES REQUIREMENTS:

11.3.1 Minimum Clearance Requirements

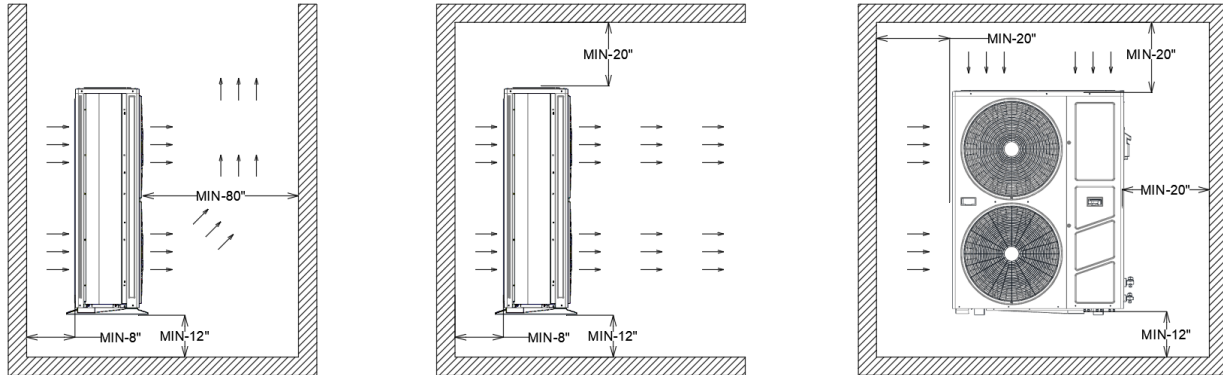

The installation and clearance requirements are the minimum. These distances need to be respected to allow the heat pump to function properly. Failure to do so will result in a loss of performance, equipment failure. Other limitations include but are not limited to:

- Heat pump shall not be installed in locations where combustible gas may leak.
- Heat pump shall not be installed in locations where oil or corrosive materials are present.
- Heat pump shall not be installed in a location where falling objects such as snow or ice from rooftops could damage the equipment.
- The heat pump must be installed with all local, provincial, state, and federal requirements and regulations regarding the correct methods of affixing the equipment, refrigerant line-sets, piping and electrical connections to the equipment or structures.
- Heat pump should be installed in an open and naturally ventilated space.
- Heat pump should be installed on concrete base or steel bracket, and on antivibration pads.
- Install a Strainer at the inlet of heat pump when circulating water quality is not adequate.
- Use adequate fasteners to install the unit to the structure, rack, bracket, or pad. Failure to do so may result in accidental tip-over of the machine and damage to the equipment.
- For Multiple Heat Pump Installation, never install heat pumps in series. Only parallel installation is allowed.

11.3.2 Good Practices

- Install an automatic air vent at the highest point of each water circulations network for releasing air from water system.
- Verify annually all the support fasteners, brackets and other related equipment for corrosion, damage, and proper torque specifications.
- Remove excess snow and ice around the heat pump to prevent damage to the equipment.

11.3.3 Installation Prerequisites:

Heat Pumps are shipped in closed crates. Please open crates as well as front panel to have access to wiring (Power Supply and Control) terminals:



11.3.3.1 HSS030V2LM

1	2	3	4	5	6	7	8	9	10	11	12	13	14	
PUMP POWER OUTPUT (L1)	PUMP POWER OUTPUT (L2)	floor heat valve (L1)	(L2)	Hot water valve (L1)	Water flow sw	COM	A.C turn on/ off sw	Cool link age sw	Heat link age sw	COM	PWM sig nal	Aux. elec. heater turn on/ off sw		

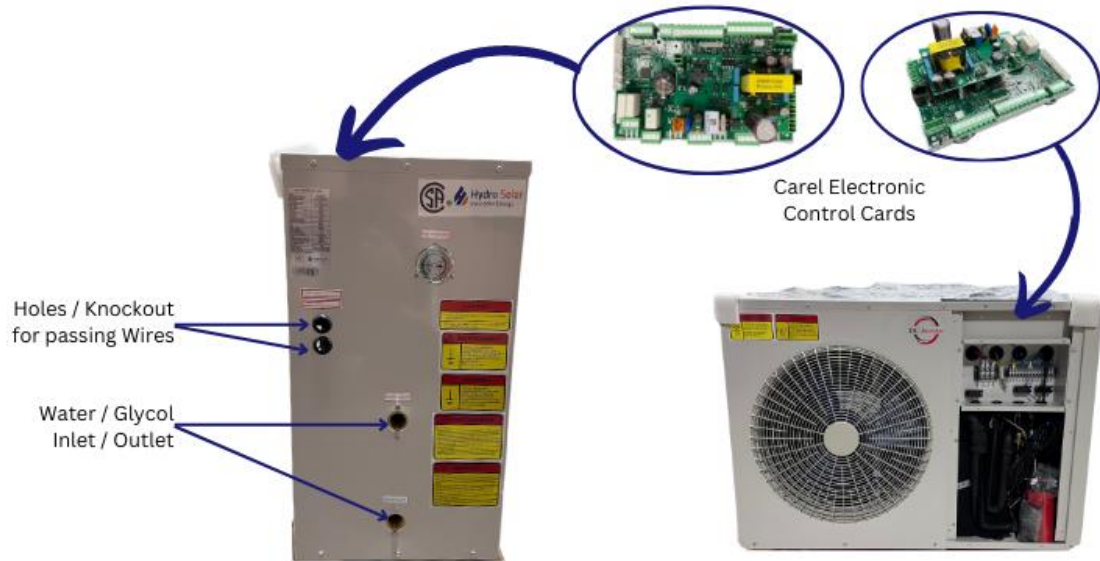

11.3.3.2 HSS060V2LM

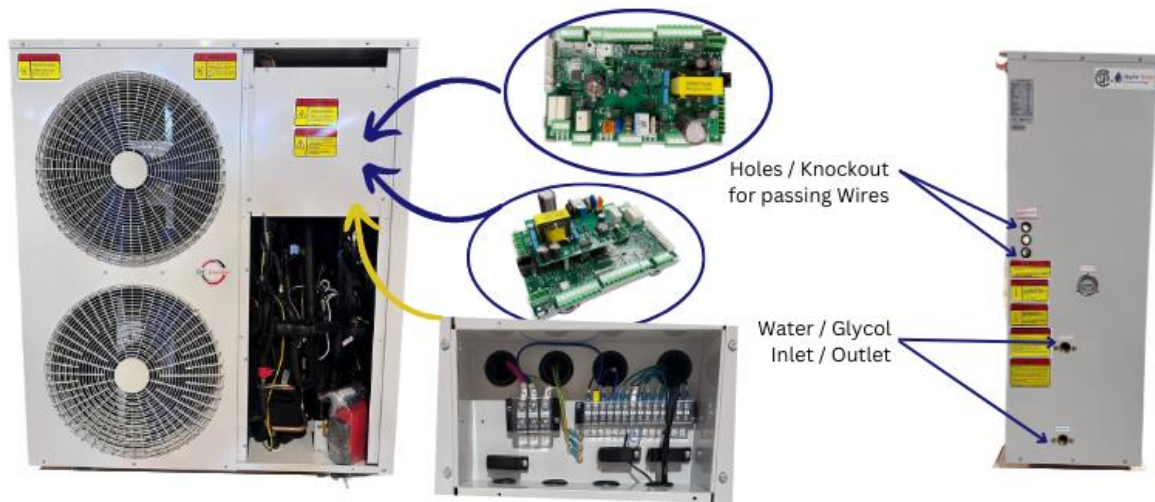

11.3.3.3 HSS080V2LM

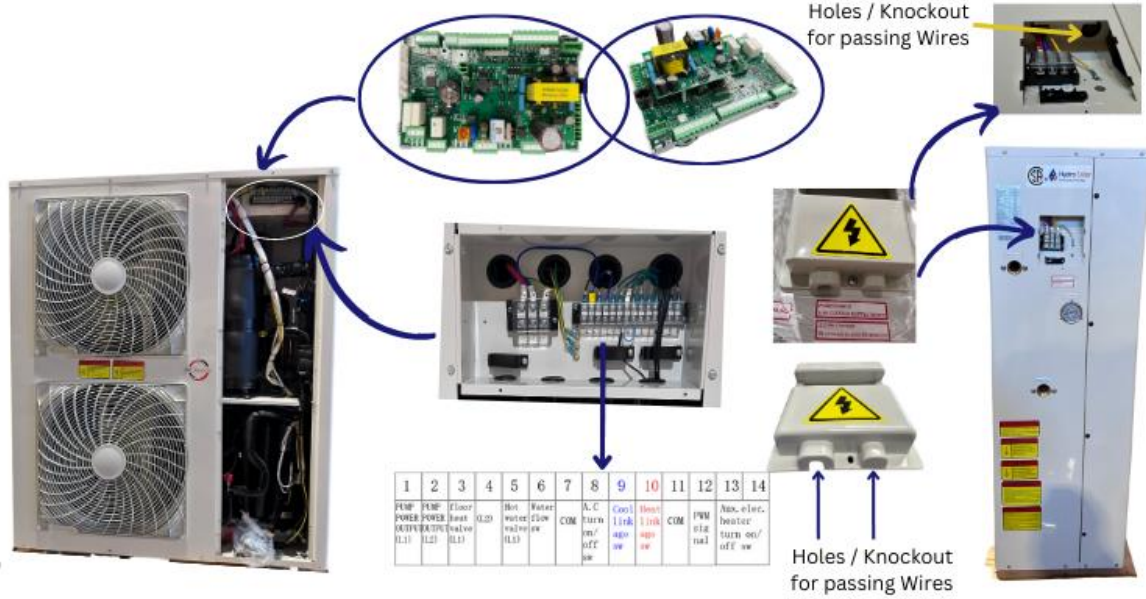



12 OPERATION

12.1 STANDALONE MODE

Annex "C" has the full controller menu of for Heat Pump. It shows the tree sequences of menus and sub-menus.

12.1.1 Main interface

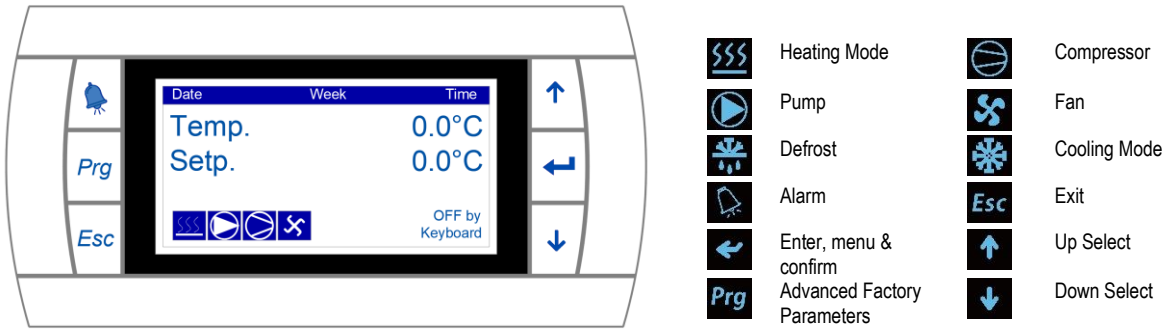

12.1.2 Turn on/off

Press to access menu, press button to On/Off Unit, press to confirm. Press Button to turn on/off press to confirm :

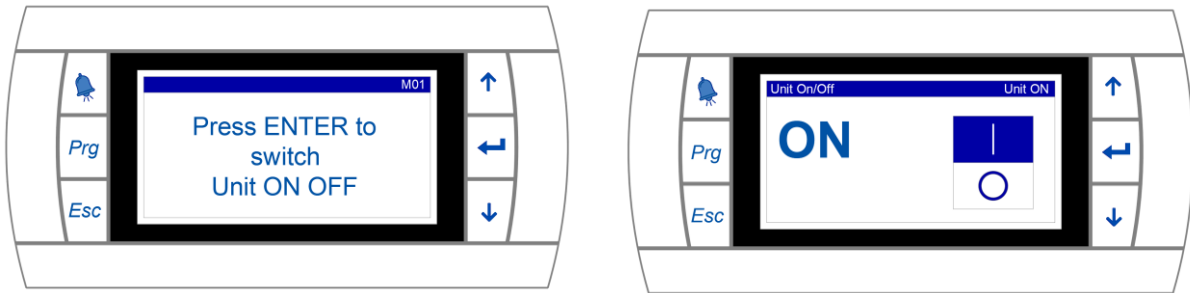

This control allows user access to the ON/OFF switch of the heat pump.

Press to access the below digital ON/OFF button.

Use arrows to switch Heat Pump between ON and OFF mode.

12.1.3 Operating Modes (Heating, Cooling, Hot water, Hot water+cooling, Hot water+heat)

Press to access menu, press button to select User Mask, then press to confirm. Press Button to switch mode, and press to confirm, Egc. Mode switching & Temperature setting. (N.B: Turn Off Heat Pump before changing operating mode.)

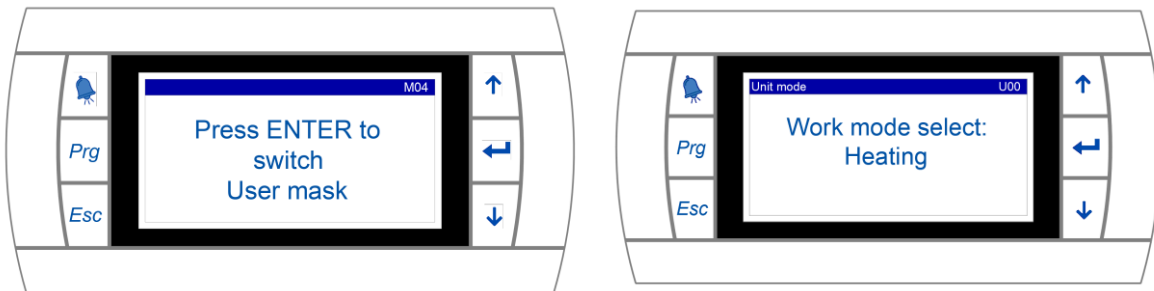



This control allows user access operating mode five possible selections. Press  to access the below digital selection button.

There are 5 possible operating modes: Heating (Space Heating) , Cooling (Space Cooling), **Hot water** (domestic Hot Water), Hot water + cooling Combination, Hot water + heating Combination.

Temperature Set Point interface is as follows:

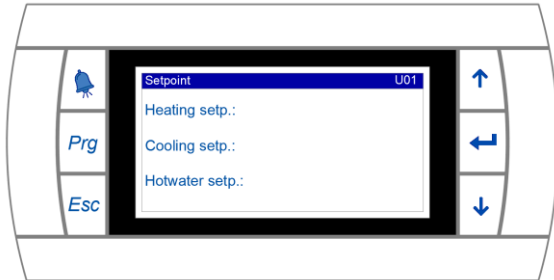

This control allows changing the set points of the heat transfer fluid temperatures. By default, setpoints are assigned to return fluid temperatures. This means that heat pump, by default modulates its capacity to maintain fluid return temperature sensor at its setpoint. In the advanced settings, set points can be assigned to supply fluid temperatures.

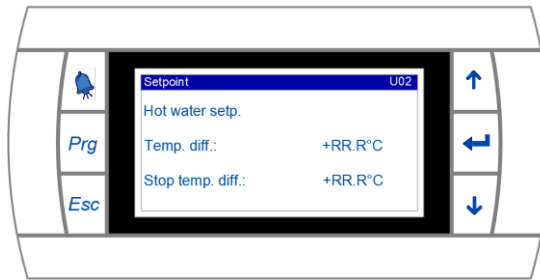

This control allows changing the domestic hot water (DHW) temperature setpoint of the DHW heating tank. Temperature difference between supply and return setting is by default 5°C and Stop Temperature difference is the temperature difference at which heat pump stops heating DHW tank.

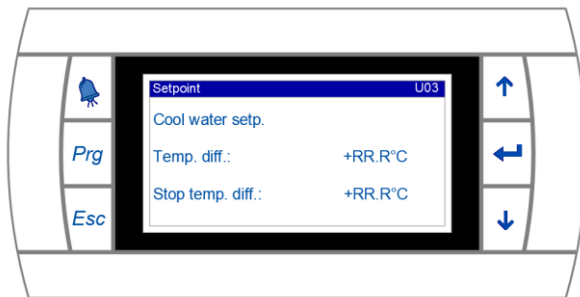

This control allows changing the chilled water temperature setpoint. Temperature difference between supply and return setting is by default 5°C and Stop Temperature difference is the temperature difference at which heat pump stops chilled water production.

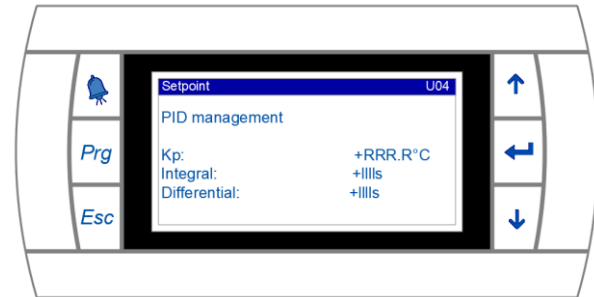

This control allows changing the parameters of PID (*proportional, integral, and derivative*) control loop used in temperature control.

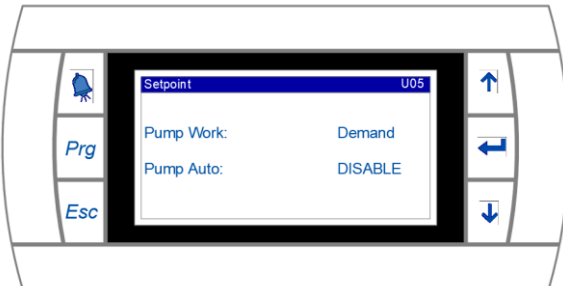

This control allows the selection of the pump operation: Always ON, On Demand or Intermittently Open. When Fluid Supply or Return Temperature Sensor is inserted in the space Heating/Cooling tank's thermal well, Pump Work Option can be set to ON Demand. When no sensor is inserted into the thermal well of the tank, Pump Work Option shall be set to either always ON or to Intermittently Open. In this case Pump will run for every pre-set time interval to be able to measure demand temperature.

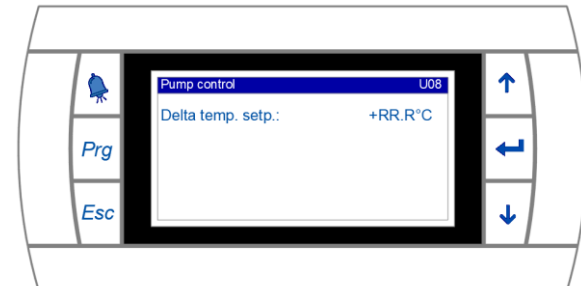

Control of this heat pump has a PWM signal for modulating heat transfer fluid circulation pump speed. Pump speed is modulated, via the Carel Controller in order to maintain temperature difference setpoint between supply and return at its set point.

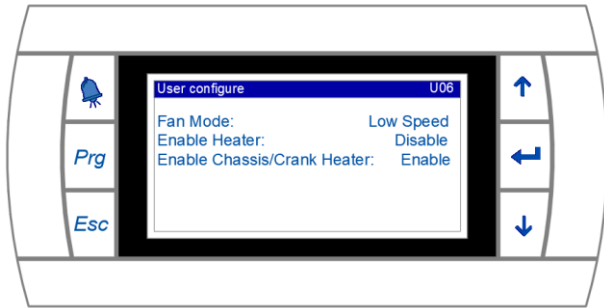

Fan Mode set up has three options: Day Mode, Night Mode and Low Speed Mode. When Day Mode is selected, Compressor runs at the current ambient temperature maximum speed.

Fan Speed is increased when compressor speed is increased.

When Night Mode is selected and during the period between 20:00 to 8:00 of the real-time clock (adjustable in clock settings), Fan Speed is Limited to its upper limit (500 rpm Adjustable), and compressor speed is limited to its upper limit (50Hz adjustable).

When Low Speed Mode is selected, compressor and speed is modulated to match heating/cooling demand and fan speed is modulated accordingly.

Heater (Backup Heater) shall be Enabled in this control. Crank Heater shall be Enabled when Heat Pump is equipped with Crank Heater and is in snowy area.

Compressor Speed Vs Outdoor Temperature		
Outdoor Dry Bulb Temperature (°C)	Compressor Max Frequency (Hz)	Operating Mode
9<AmbTemp	50	Hot Water Heating / Heating
4<AmbTemp<=9	60	
-3< AmbTemp <=4	60	
-9<AmbTemp<=-3	65	
-15<AmbTemp<=-9	65	
AmbTemp<=-15	70	
38<AmbTemp	65	Cooling
33<AmbTemp<=38	65	
30<AmbTemp<=33	60	
26<AmbTemp<=30	60	
AmbTemp<=26	55	

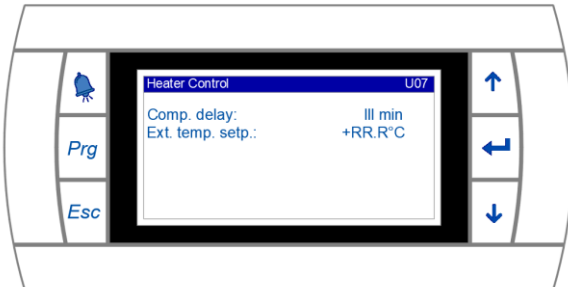

The Comp.delay Control defines time delay between Back-up Heater and compressor operation (default 50min – that means that Backup Heater is authorized to work after 50 min of compressor operation). Ext.temp.setp. is the upper limit of Back-up Heater operating temperature (Default value is -15°C – that means that if the outdoor temperature is above -15°C, Back-up heater is not authorized to run).

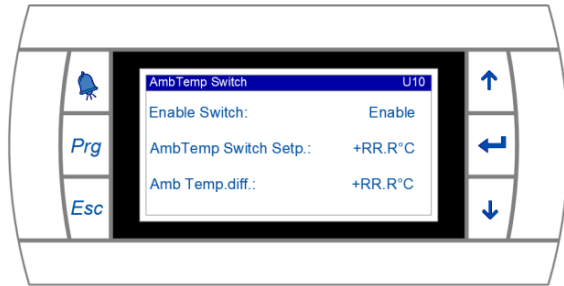

This Control allows user to enable/disable heat pump operating modes (mainly Space Heating and Cooling) based on outdoor temperature. When outdoor temperature is above "AmbTem Switch Setp." assigned value, Heat Pump goes into cooling mode (default 20°C). When outdoor temperature drops below "AmbTem Switch Setp." (20°C) – "Amb Temp.diff" (4°C), Heat Pump goes into heating mode.

N.B:

When cooling/Heating demand is not sent to the heat pump by an external source (via cooling/Heating linkage) and is managed by the heat pump Ambient Temperature Sensor (Located outdoor), Ambient Temperature switch **AmbTemp Switch (in U10)** shall be enabled. Typical set point **Setp: (in U10)** ranges between 10-18°C (45 to 65°F). Ambient Temperature Differential **Amb Tem.diff (in U10)** is simply a dead band. When Heating / Cooling signal is sent to the heat pump via Cooling/Heating Linkages or via modbus, Ambient Temperature switch **AmbTemp Switch (in U10)** shall be disabled.

12.1.4 Outdoor Temperature Reset for HP Supply/Return Temperature

12.1.4.1 Outdoor Temperature Reset for Space Heating Hot Water Temperature

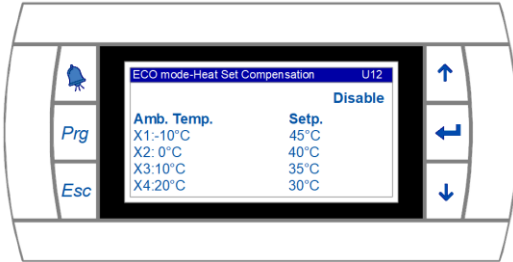

This control allows the increasing of Space Heating hot water temperature when outdoor temperature decreases and the decreasing of space heating hot water temperature when outdoor increases. Disabled by Default. To enable, go to disable and change it to Enable.

Space Heating Temp. RESET Vs Outdoor Temp.

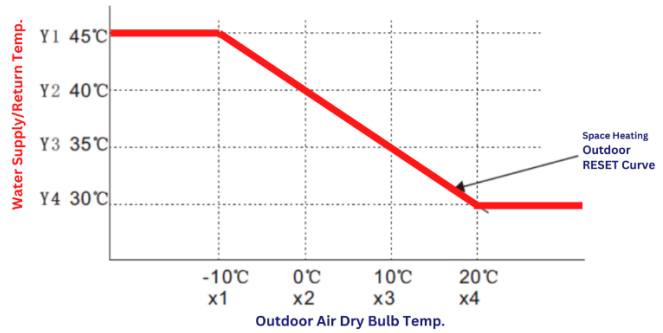

12.1.4.2 Outdoor Temperature Reset for DHW Temperature

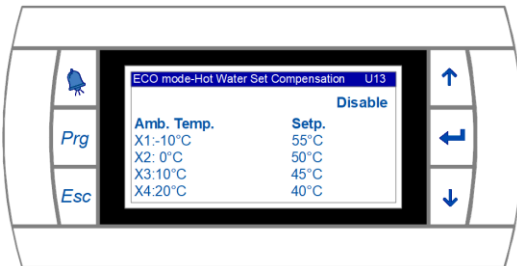

This control allows the increasing of Domestic Hot Water (DHW) temperature when outdoor temperature decreases and the decreasing of DHW temperature when outdoor increases. Disabled by Default. To enable, go to disable and change it to Enable.

DHW Heating Temp. RESET Vs Outdoor Temp.

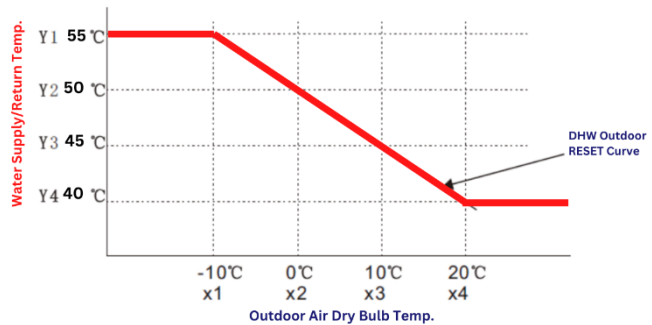

12.1.4.3 Outdoor Temperature Reset for Chilled Water Temperature

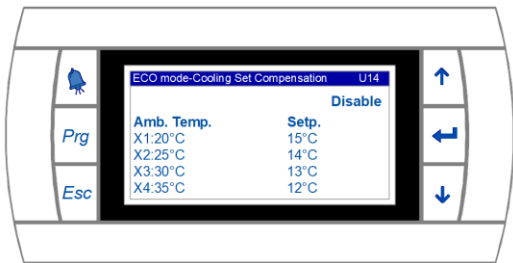

This control allows the increasing of chilled water temperature when outdoor temperature decreases and the decreasing of chilled water temperature when outdoor increases. Disabled by Default. To enable, go to disable and change it to Enable.

Chilled Water Temp. RESET Vs Outdoor Temp.

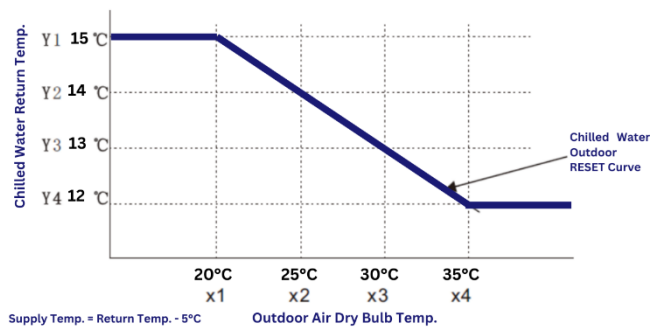



12.1.5 TimeZone/CLOCK

Press to access menu, press \uparrow/\downarrow button to select TimeZone/CLOCK, then press to confirm, Press \uparrow/\downarrow Button to change the setting, and press to confirm.

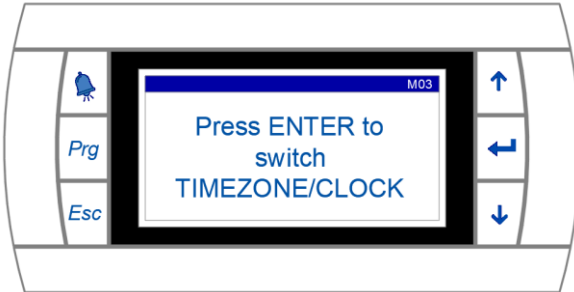

M03 menu allows user to set heat pump ON/OFF schedules and assign different temperature setpoints values to each schedule.



M03/C101 submenu, allows user to change date/time/day

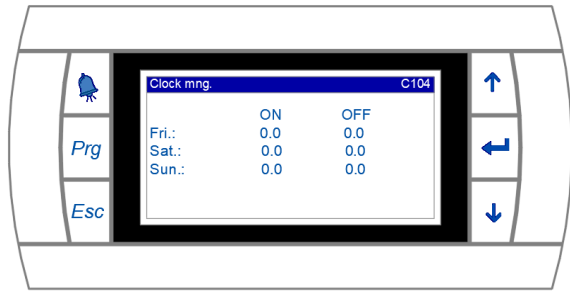
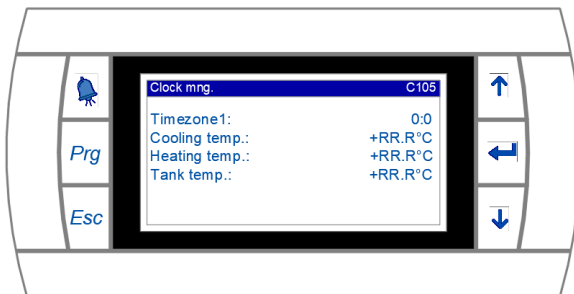
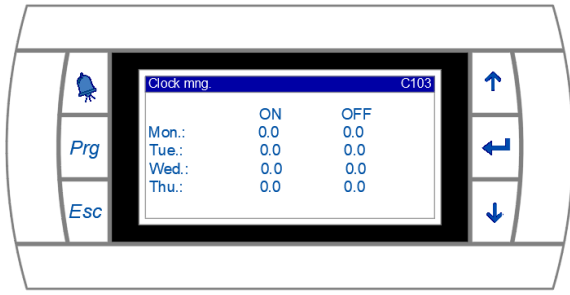
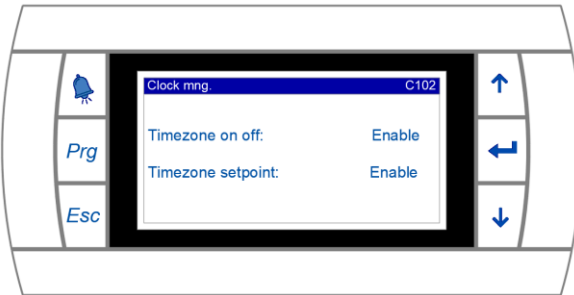

C103 & 104: Schedule setup interface. Heat Pump is authorized to work when time reaches "ON" time of the day, and it's turned off when time reaches "OFF" time of the day.

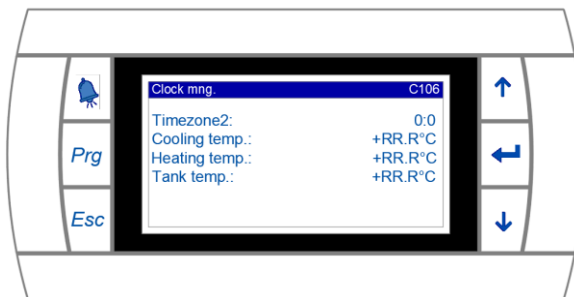

C105, 106, 107 & 108: Timezone1 is the start time of the first period, Timezone2 is the cut-off time of the first period and the start time of the second period, and so on (Timezone 3 and 4).

"Cooling temp.," "Heating temp.," and "Tank temp.," Set temperatures for cooling, heating, and domestic hot water for the corresponding period.

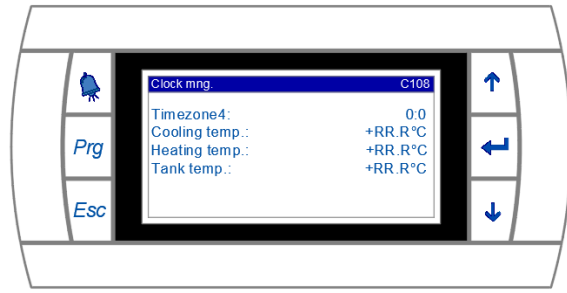
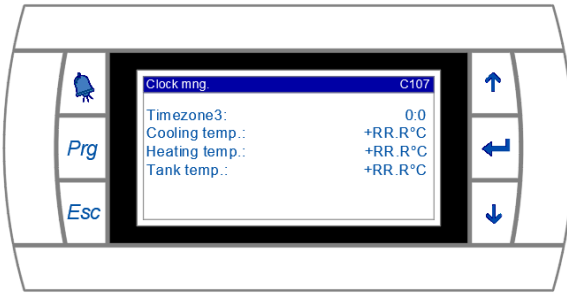

12.1.6 Default Settings

Setting Parameter	Initial Value
Unit mode	Heating
Space Heating setpoint	45°C
Space Cooling setpoint	12°C
Domestic Hot water setpoint	50°C
Temp. diff.	5°C
Stop temp. diff.	0°C
Cool and heat mode Temp. diff.	5°C
Stop temp. diff.	2°C
Kp (PID Control Loop)	5°C
Integral (PID Control Loop)	200s
Differential (PID Control Loop)	0s
Pump Operation	Demand
Pump Auto	Enable
Fan model	Daytime
Enable heater	Enable
Enable chassis/crack heater	Enable
Heater control-Comp. delay	60min
Heater control-Exterior temp.setp.	5°C
Pump control, Delta temp. set.	5°C
Auto start	Enable

12.2 HYBRID OPERATING MODE: HEATING COOLING DEMAND BY EXTERNAL SOURCES

In this operating mode, heating and or cooling demand are sent to the heat pump via either switching relays (such as Taco, Tekmar, Caleffi, etc...) or via binary outputs of a Digital Controller. In either cases, and since switching between heating and cooling is not managed by the heat pump ambient temperature switch, it shall be disabled:

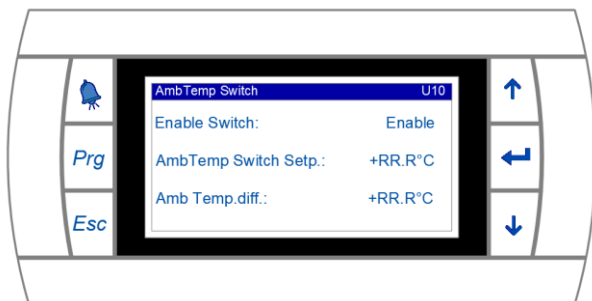

1	2	3	4	5	6	7	8	9	10	11	12	13	14
PUMP POWER OUTPUT (L1)	PUMP POWER OUTPUT (L2)	floor heat valve (L1)	(L2)	Hot water valve (L1)	Water flow sw	COM	A. C turn on/off sw	Cool link age sw	Heat link age sw	COM	PWM signal	Aux. elec. heater turn on/off sw	

When Heating / Cooling signal is sent to the heat pump via Cooling/Heating Linkages, Ambient Temperature switch **AmbTemp Switch (in U10)** shall be disabled.

12.3 INSTALLATION OF WIFI ADAPTER

While the Wi-fi adapter is not required to the functioning of the unit; it allows for faster diagnosis as well as remote diagnosis and monitoring. The application is designed in a way to be significantly more user-friendly to the client when compared to the Carel controller and reduces time. Technicians will be able to troubleshoot the equipment without going on site.

12.3.1 Hardware Installation & Connection:

The WIFI adapter kit is shipped inside the Heat Pump and has the following components:

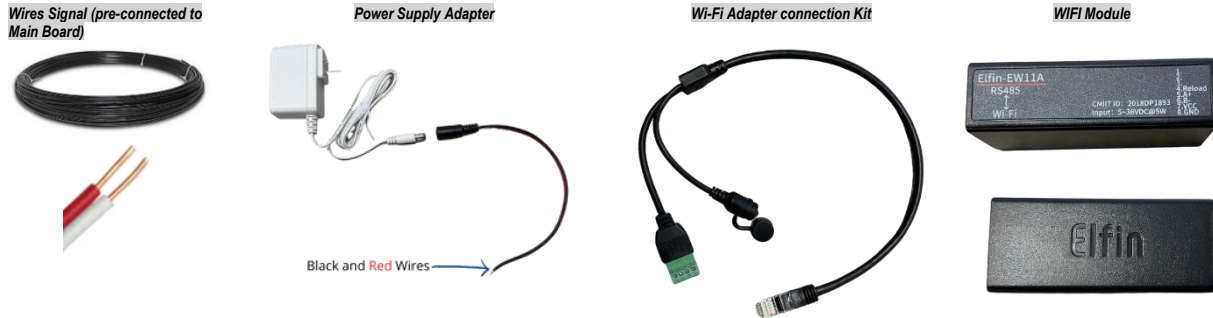

*****please note that the pictured equipment, wiring is subject to change without prior notice and will be supplemented with revision sheets if required*****

The signal cable has 2 wires: one red and one white.

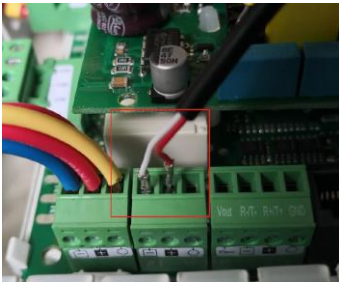

On the **control board** of the Heat Pump outdoor unit:

- 1- Check that **white** wire of the signal line is connected to the Minus (-) port.
- 2- Check that **red** wire of the signal line is connected to the Plus (+) port.



On the **Green Plug** of the WIFI Cable:

- 1- Connect the **white** wire of the signal line to the **B** port.
- 2- Connect the **red** wire of the signal line to the **A** port.
- 3- Connect the **Black/White** wire of the Power Supply Adapter to the **plus (+)** port.
- 4- Connect the **Black** wire of the Power Supply Adapter to the **minus (-)** port.
- 5- Connect the power supply adapter to a 110-240VAC power supply plug.

Please strictly follow the above wires connection instructions or else WIFI module will not work.

12.3.2 Application downloads and setup:



Hydro Solar
Utilities

OPEN

Heat Pump application is called **Hydro Solar** and is available for Apple and Android devices. Go to the application stores of your smart phone and download the **free Heat Pump Pro** App. After downloading Heat Pump's application look for the application icon on your smartphone screen and click on it. Register your device as shown below:



When logging in for the first time, you will need to create an account. You could do so by clicking on **User Register** icon.

Once clicked the screen on the right will appear, where you have the option of either registering by phone or by email.

We do recommend email registration.

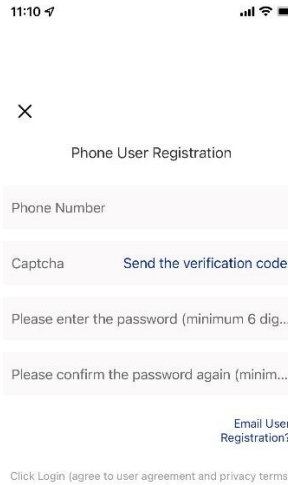

To register by phone, please enter your phone number and click on Send the verification code. Once code is received enter it below and go the next screen.

For email registration click on **Email User Registration?**

Once **Email User Registration?** is clicked, the below screen will appear



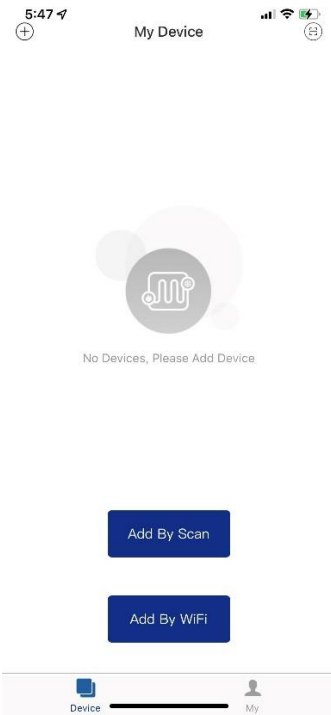

To add the heat pump, you could either click on **Add by WIFI** or **Add by Scan**:



Simply scan the barcode on your heat pump (add by scan option)

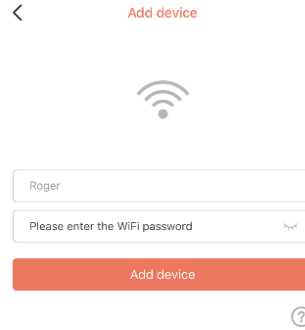

Add By WIFI:

Choose your WIFI network from the list and enter the password below.

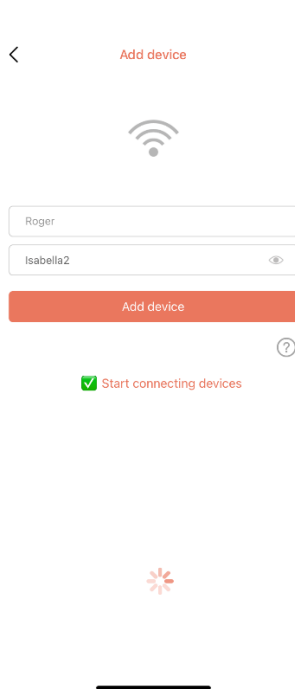

How to add device?

Please connect this mobile device to home Wi-Fi first

1. Return to the home page on this mobile device
2. Open "Settings" and select "Wireless LAN"
3. Choose home Wi-Fi
4. Open the current application, return to the "Add Device" page, allow app to access your location, and enter the WiFi password

Then, make the device visible

1. Connect the Heat Pump WiFi adapter to plug and the green light will flash slowly
2. Open the button cap on the Wifi adaptor cable, Press button for less than 2 seconds
3. Wait for about 2 ~ 3 seconds, the green light on the WiFi adaptor starts to flash quickly, and Wifi adaptor enters the Pairing mode

Add device

1. Go to the "Add Device" page of the current application
2. Enter the home Wi-Fi password
3. When the WiFi adaptor green light flashes quickly, click the "Add Device" button
4. After the prompt "Pairing successful", the device will be automatically added to your device list

Note: The green light of Wifi adaptor flashes quickly to indicate that it has entered the pairing mode, and the flashing light changes to steady on to indicate that the device is connected to the home Wi-Fi network.

To pair the application with heat pump WiFi adapter, Simply open the button's black cap as shown below



And gently press the button for 2-3 seconds as described on the left instructions.

You could connect more than one heat pump to the app. Simply click on add device and repeat the above steps again.

12.3.3 Device List Windows:

- The device list displays the device (Heat Pumps) associated with this user and shows the device's online and offline status. When the device is offline, the device icon is gray, and the device is online color.
- The switch on the right side of each device row indicates whether the device is currently turned on.
- The user can disconnect the device or modify the device name. When swiping to the left, the delete and edit buttons appear on the right side of the device row. Click Edit to modify the device name, and click Delete to disconnect the device and delete it from the application, as shown below:

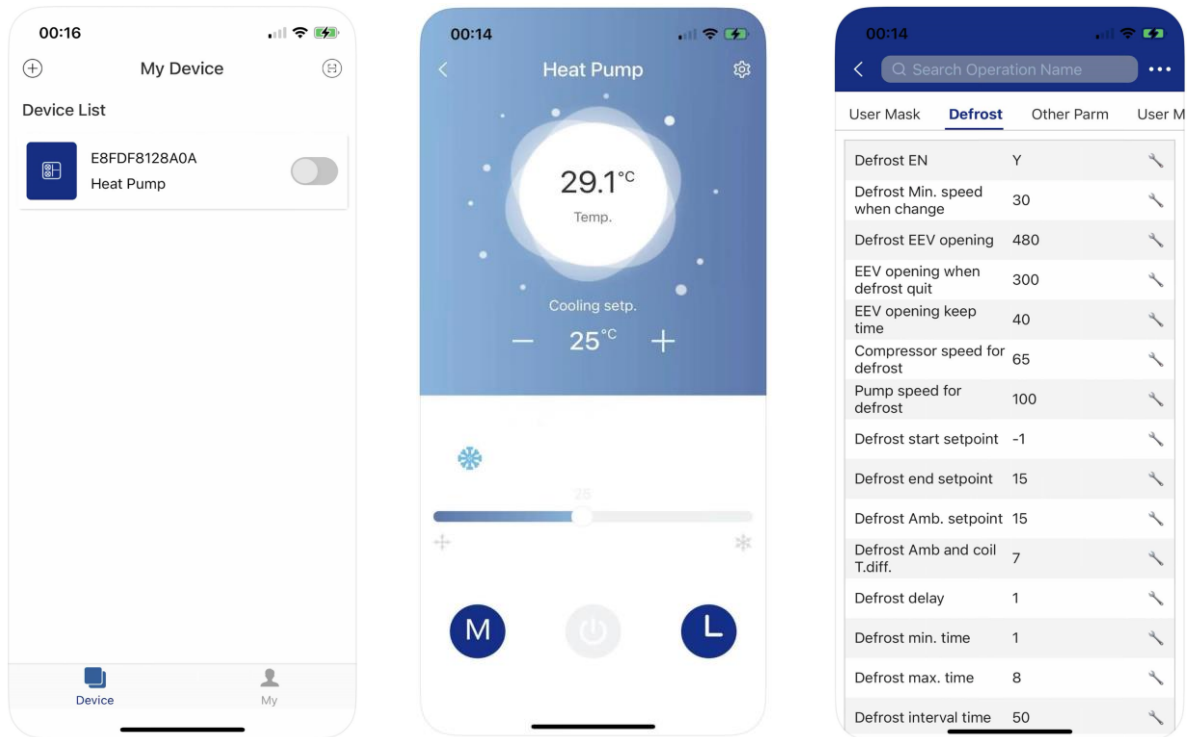

12.3.4 Application usage guide:

1. Click a device in the device list to enter this page.
2. The background color of the bubble indicates the current operating state of the device:
 - a. Gray indicates that the device is in the shutdown state, at this time, you can change the working mode, set the mode temperature, set the timing, or you can press the key to switch on and off.
 - b. Multicolor indicates that the device is turned on, each working mode corresponds to a different color, orange indicates heating mode, red indicates hot water mode, and blue indicates cooling mode.
 - c. When the device is in the power-on state, you can set the mode temperature, set the timer, press the key to switch on and off, but you cannot set the working mode (that is, the working mode can only be set when the device is off)
3. The bubble shows the current temperature of the device.
4. Below the bubble is the set temperature of the device in the current operating mode.
5. Set the temperature is about \pm , $=$ button, each click adds or subtracts 1 to the set point value to the device.
6. Below the bottom left, of set point temperature window, is the Fault and Alert. When the device starts to alarm, the specific Alert.
7. Fault or alarm's reason will be displayed next to the yellow warning icon. In case of device Fault or Alert, the Fault and Alert content will be displayed in the bottom right of the set point temperature window. Click this area to jump to the details of the Error.



13 WARRANTY (LIMITED RESIDENTIAL WARRANTY)

Aqua Solanor Inc (Owner of **Hydro Solar Innovative Energy**) warrants that the heat pumps supplied by it shall be free from defects in materials and workmanship for a period of **Five (5) Five YEARS** after the date of installation or for a period **(5) Five YEARS AND (30) THIRTY DAYS** after the date of shipment, whichever occurs first.

Aqua Solanor Inc shall, at its option repair or replace any part or parts covered by this warranty which shall be returned to **Aqua Solanor Inc**, transportation charges prepaid (by customer), which, upon examination proves to be defective in materials or workmanship.

Replacement or repaired parts and components are warranted only for the remaining portion of the original warranty period.

This warranty is subject to the following conditions:

1. The **Hydro Solar Innovative Energy** heat pump must be properly installed and maintained in accordance with this installation and maintenance document and in compliance with Federal, Provincial, Municipal, and local codes and regulations.
2. The installer must be a certified qualified heat pump installer in the province/state where the heat pump is installed. Failure to comply with this requirement will void this warranty.
3. The installer must complete an installation and commissioning report have it endorsed by the owner and return it to **Hydro Solar Innovative Energy** within 21 days of installation of the unit. The installer must fill up the [Heat Pump Warranty Registration Form](#) which will provide them with a Warranty Unique ID. To make a warranty claim, the buyer must present a valid Warranty Unique ID.
4. It is the responsibility of the building or general contractor to supply temporary heat to the structure prior to occupancy. These heat pumps are designed to provide heat only to the finished and insulated structure. Start-up of the unit shall not be scheduled prior to completion of construction and final Duct/Pipe installation for validation of this warranty.
5. It is the customer's responsibility to supply the proper quantity and quality of water.

If the heat pump, supplied by **Aqua Solanor Inc**, fails to conform to this warranty, **Aqua Solanor Inc** 's sole and exclusive liability shall be, at its option, to repair or replace any part or component which is returned by the customer during the applicable warranty period set forth above, provided that (1) **Aqua Solanor Inc** is promptly notified in writing upon discovery by the customer that such part or component fails to conform to this warranty. (2) The customer returns such part or component to **Aqua Solanor Inc**, transportation charges prepaid, within (30) thirty days of failure, and (3) **Aqua Solanor Inc**'s examination of such component shall disclose to its satisfaction that such part or component fails to meet this warranty and the alleged defects were not caused by accident, misuse, neglect, alteration, improper installation, repair, or improper testing.



-
- 14 ANNEX “A” – ERROR CODES LIST**
 - 15 ANNEX “B” – HEAT PUMPS TROUBLESHOOTING SCHEDULE**
 - 16 ANNEX “C” – HEAT PUMPS CONTROLLER MENUS AND SUB-MENUS TREE**
 - 17 ANNEX “D” – HEAT PUMPS PERFORMANCE IN DOMESTIC HOT WATER MODE**
-

Error Code	Description
AL001	Too many mem writings
AL002	Retain mem write error
AL003	Inlet probe error
AL004	Outlet probe error
AL005	Ambient probe error
AL006	Condenser coil temp
AL007	Water flow switch
AL008	Phase sequ.prot.alarm
AL009	Unit work hour warning
AL010	Pump work hour warning
AL011	Comp.work hour warning
AL012	Cond.fan work hourWarn
AL013	Low superheat - Vlv.A
AL014	Low superheat - Vlv.B
AL015	LOP - Vlv.A
AL016	LOP - Vlv.B
AL017	MOP - Vlv.A
AL018	MOP - Vlv.B
AL019	Motor error - Vlv.A
AL020	Motor error - Vlv.B
AL021	Low suct.temp. - Vlv.A
AL022	Low suct.temp. - Vlv.B
AL023	High condens.temp.EVD
AL024	Probe S1 error EVD
AL025	Probe S2 error EVD
AL026	Probe S3 error EVD
AL027	Probe S4 error EVD
AL028	Battery discharge EVD
AL029	EEPROM alarm EVD
AL030	Incomplete closing EVD
AL031	Emergency closing EVD
AL032	FW not compatible EVD
AL033	Config. error EVD
AL034	EVD Driver offline

Error Code	Description
AL035	BLDC-alarm:High startup DeltaP
AL036	BLDC-alarm:Compressor shut off
AL037	BLDC-alarm:Out of Envelope
AL038	BLDC-alarm:Starting fail wait
AL039	BLDC-alarm:Starting fail exceeded
AL040	BLDC-alarm:Low delta pressure
AL041	BLDC-alarm:High discharge gas temp
AL042	Envelope-alarm:High compressor ratio
AL043	Envelope-alarm:High discharge press.
AL044	Envelope-alarm:High current
AL045	Envelope-alarm:High suction pressure
AL046	Envelope-alarm:Low compressor ratio
AL047	Envelope-alarm:Low pressure diff.
AL048	Envelope-alarm:Low discharge pressure
AL049	Envelope-alarm:Low suction pressure
AL050	Envelope-alarm:High discharge temp.
AL051	Power+ alarm:01-Overcurrent
AL052	Power+ alarm:02-Motor overload
AL053	Power+ alarm:03-DCbus overvoltage
AL054	Power+ alarm:04-DCbus undervoltage
AL055	Power+ alarm:05-Drive overtemp.
AL056	Power+ alarm:06-Drive undertemp.
AL057	Power+ alarm:07-Overcurrent HW
AL058	Power+ alarm:08-Motor overtemp.
AL059	Power+ alarm:09-IGBT module error
AL060	Power+ alarm:10-CPU error
AL061	Power+ alarm:11-Parameter default
AL062	Power+ alarm:12-DCbus ripple
AL063	Power+ alarm:13-Data comm. Fault
AL064	Power+ alarm:14-Thermistor fault
AL065	Power+ alarm:15-Autotuning fault
AL066	Power+ alarm:16-Drive disabled
AL067	Power+ alarm:17-Motor phase fault
AL068	Power+ alarm:18-Internal fan fault

Error Code	Description
AL069	Power+ alarm:19-Speed fault
AL070	Power+ alarm:20-PFC module error
AL071	Power+ alarm:21-PFC overvoltage
AL072	Power+ alarm:22-PFC undervoltage
AL073	Power+ alarm:23-STO DetectionError
AL074	Power+ alarm:24-STO DetectionError
AL075	Power+ alarm:25-Ground fault
AL076	Power+ alarm:26-Internal error 1
AL077	Power+ alarm:27-Internal error 2
AL078	Power+ alarm:28-Drive overload
AL079	Power+ alarm:29-uC safety fault
AL080	Power+ alarm:98-Unexpected restart
AL081	Power+ alarm:99-Unexpected stop
AL082	Power+ safety alarm:01-Current meas.fault
AL083	Power+ safety alarm:02-Current unbalanced
AL084	Power+ safety alarm:03-Over current
AL085	Power+ safety alarm:04-STO alarm
AL086	Power+ safety alarm:05-STO hardware alarm
AL087	Power+ safety alarm:06-PowerSupply missing
AL088	Power+ safety alarm:07-HW fault cmd.buffer
AL089	Power+ safety alarm:08-HW fault heater c.
AL090	Power+ safety alarm:09-Data comm. Fault
AL091	Power+ safety alarm:10-Compr. stall detect
AL092	Power+ safety alarm:11-DCbus over current
AL093	Power+ safety alarm:12-HWF DCbus current
AL094	Power+ safety alarm:13-DCbus voltage
AL095	Power+ safety alarm:14-HWF DCbus voltage
AL096	Power+ safety alarm:15-Input voltage
AL097	Power+ safety alarm:16-HWF input voltage
AL098	Power+ safety alarm:17-DCbus power alarm
AL099	Power+ safety alarm:18-HWF power mismatch
AL100	Power+ safety alarm:19-NTC over temp.
AL101	Power+ safety alarm:20-NTC under temp.
AL102	Power+ safety alarm:21-NTC fault

Error Code	Description
AL103	Power+ safety alarm:22-HWF sync fault
AL104	Power+ safety alarm:23-Invalid parameter
AL105	Power+ safety alarm:24-FW fault
AL106	Power+ safety alarm:25-HW fault
AL107	Power+ safety alarm:26-reseved
AL108	Power+ safety alarm:27-reseved
AL109	Power+ safety alarm:28-reseved
AL110	Power+ safety alarm:29-reseved
AL111	Power+ safety alarm:30-reseved
AL112	Power+ safety alarm:31-reseved
AL113	Power+ safety alarm:32-reseved
AL114	Power+ alarm:Power+ offline
AL115	EEV alarm:Low superheat
AL116	EEV alarm:LOP
AL117	EEV alarm:MOP
AL118	EEV alarm:High condens.temp.
AL119	EEV alarm:Low suction temp.
AL120	EEV alarm:Motor error
AL121	EEV alarm:Self Tuning
AL122	EEV alarm:Emergency closing
AL123	EEV alarm:Temperature delta
AL124	EEV alarm:Pressure delta
AL125	EEV alarm:Param.range error
AL126	EEV alarm:ServicePosit% err
AL127	EEV alarm:ValveID pin error
AL128	Low press alarm
AL129	High press alarm
AL130	Disc.temp.probe error
AL131	Suct.temp.probe error
AL132	Disc.press.probe error
AL133	Suct.press.probe error
AL134	Tank temp.probe error
AL135	EVI SuctT.probe error
AL136	EVI SuctP.probe error

Error Code	Description
AL137	Flow switch alarm
AL138	High temp. alarm
AL139	Low temp. alarm
AL140	Temp.delta alarm
AL141	EVI alarm:Param.range error
AL142	EVI alarm:Low superheat
AL143	EVI alarm:LOP
AL144	EVI alarm:MOP
AL145	EVI alarm:High condens.temp.
AL146	EVI alarm:Low suction temp.
AL147	EVI alarm:Motor error
AL148	EVI alarm:Self Tuning
AL149	EVI alarm:Emergency closing
AL150	EVI alarm:ServicePosit% err
AL151	EVI alarm:ValveID pin error

Fault code	Panel description	Detail description	Possible cause	Diagnostics method	What to do?
AL001	AL001 Too many mem writings	Storage type variables are excessively and frequently written/modified	parameters modified frequently	Frequently modify parameters	Stop operating the controller for 3 minutes or power off for 3 minutes
AL002	AL002 Retain mem write error	Frequent alarms for writing errors in storage variables	parameters modified frequently	Frequently modify parameters	Stop operating the controller for 3 minutes or power off for 3 minutes
AL003	AL003 Inlet probe error	Space heating temperature sensor failure	1. Loose wire / broken wire / faulty probe	Visual inspection	Tighten the wire/reconnect the wire/replace the sensor probe
AL004	AL004 Outlet probe error	Outlet probe failure	1. Loose wire / broken wire / faulty probe	Visual inspection	Tighten the wire/reconnect the wire/replace the probe
AL005	AL005 Ambient probe erro	Ambient temp. probe failure	1. Loose wire / broken wire / broken probe	Visual inspection	Tighten the wire/reconnect the wire/replace the probe
AL006	AL006 Condenser coil temp.	Coil pipe probe failure	1. Loose wire / broken wire / broken probe	Visual inspection	Tighten the wire/reconnect the wire/replace the probe
AL007	AL007 Water flow switch	Water flow switch alarm	1. Strainer is blocked, resulting in increased friction loss and a smaller water flow	Smaller water flow	Clean the strainer
			2. Circulation pump is undersized	Smaller water flow	Replace the water pump with a larger water head and water flow one
			3. The water pump has air pockets (either in the impeller or in the piping around it)	Smaller water flow	Purge the air.
			4. The valve of the water system is closed or not fully opened	Smaller water flow	Open the valve
			5. There is air in either supply or return pipe, which leads to poor water flow	Smaller water flow	Install an automatic air vent valve at the highest point of the piping system
			6. The water flow switch is broken	If all the above are excluded, pls short-circuit the water flow switch and force heat pump to start. If the outlet water temperature is more than 8 degrees above the water tank temperature, then pls continue the above operation. If the temperature difference is within 5 degrees and there are no errors showed, then the water flow switch is broken.	Replace the water flow switch
AL008	AL008 Phase sequ.prot.alarm	Phase sequence protection switch alarm	Abnormal parameter setting	Three phase device reports failure	Set DI5 of Ot6 page in M09 to normally open NO
AL013	AL013 Low superheat - Vlv.A	EEV valve A low superheat alarm	The unit has heavy frost	Visually check for frost	Lower the coil temperature difference on the Df05 sub-menu in M10
			The unit has been operating at low frequency for a long time	Check unit's running frequency	Operate within the allowable frequency range
AL028	AL028 Battery discharge	EEV battery failure	The unit has strong electric interference	Report fault	Power off for 3 minutes and restart
AL037	AL037 BLDC-alarm:Out of Envelope	BLDC-Out of operating range	The water temperature is too high or the ambient temperature is too low	The ambient temperature or water temperature exceeds the allowable range	Operate within the allowable range
AL038	AL038 BLDC-	BLDC-compressor failed to	Program error	Check whether the program version is the latest	Update the latest program
AL039	AL039 BLDC-	BLDC-compressor failed to	Program error	Check whether the program version is the latest	Update the latest program
AL041/AL05 0	AL041 BLDC-alarm:High discharge gas temp	Discharge gas temp. too high protection	1. Low refrigerant charge	Low pressure is very low	Check and fix the leaks, then vacuum and charge the refrigerant according to the
			2. Inaccurate sensing of discharge gas temp.	The discharge gas temp. probe still shows	Replace discharge gas temp. probe
AL051/AL05 7/AL082	AL051 Power+ alarm:01-Overcurrent	Compressor 1/2 over current protection	1. The power supply voltage is low	Use a multimeter to measure the voltage during standby, and it is 10% lower than the nominal	Increase the voltage stabilizer to keep the voltage stable, or provide a stable voltage, or
			2. The wire diameter is too small or the wiring is loose, resulting in low voltage	Measure the voltage with a multimeter at the moment when the compressor contactor is closed, until there is current protection. If the lowest voltage displayed by the multimeter is 10% lower than the rated voltage	Replace the appropriate wire diameter, or tighten loose wiring
			3. The AC contactor of compressor is broken and not closed	Visually check whether the AC contactor is closed or not	Replace AC contactor
			4. Short circuit of compressor coil	Excluded above, measure the resistance between the three coils of the compressor. If the resistance is too small or too large, it means that the compressor is burnt	Replace compressor
AL053	AL053 Power+ alarm:03-DCbus overvoltage	Power+03-DCbus overvoltage	Voltage is too high	The actual voltage exceeds 20% of the rated voltage	Provide stable power supply voltage

Fault code	Panel description	Detail description	Possible cause	Diagnostics method	What to do?
AL054	AL054 Power+ alarm:04-DCbus undervoltage	Power+04-DCbus undervoltage	Voltage is too low	The actual voltage is lower than the rated voltage by more than 25%	Provide stable power supply voltage
AL114	AL114 Power+ alarm:Power+ offline	Inverter offline alarm	1. The interval between power-off and power-on of the host is too short	Power cycle time is less than 30 seconds	Power off again, and power on after 3 minutes, if it still doesn't work, power off for 10 minutes
			2. The inverter cable is loose	Check is screw is tight, if not	Re-tighten
			3. The position of the inverter dial switch is wrong	The directions of the four DIP switches of the inverter are inconsistent	Redial to match
AL115	AL115 EEV alarm:Low superheat	EEV low superheat alarm	The unit has heavy frost	Visually check for frost	Lower the coil temperature difference on the Df05 page in M10
			The unit has been operating at low	Check unit's running frequency	Operate within the allowable operating range
AL128	AL128 Low press alarm	Low pressure alarm	1. Heavy frost on the evaporator	The evaporator are covered with thick frost	Force defrost, keep the ambient temp. probe as far away as possible from the evaporator to prevent it from being covered by snow, and check whether the parameters are abnormal
			2. The fan motor or fan blades are broken or the speed is slow, resulting in insufficient air	The fan rotates very slowly or stops rotating	If the fan motor or fan blade is broken, replace the motor or fan blade, if the speed is slow, replace the fan capacitor
			3. System leakage of refrigerant	The low pressure is very low, and traces of oil leakage can be seen in the pipeline	Check and fix the leaks, then vacuum and fill with refrigerant according to the nameplate
			4. The low pressure switch is broken	If the low pressure meter exceeds 1kg, this fault is still reported	Replace low voltage switch
			5. Reverse connection of high and low voltage switches	Low pressure gauge pressure is higher than 1kg, but high pressure gauge is very high	Change the wiring of the high and low voltage switch and check according to the high voltage protection
AL129	AL129 High press alarm	High voltage alarm	1. The filter is blocked, resulting in a small water flow	The temperature difference between the inlet and outlet water is more than 8 degrees	Cleaning the filter
			2. Water head and water flow of the waterpump are too small, resulting in insufficient water flow	The temperature difference between the inlet and outlet water is more than 8 degrees	Replace the water pump with a larger water head and water flow
			3. The water pump has air pockets, resulting in a small water flow	The temperature difference between the inlet and outlet water is more than 8 degrees	Emptying and water pump
			4. There is air in the pipeline, which leads to poor water flow	The temperature difference between the inlet and outlet water is more than 8 degrees	Install an automatic air vent at the highest point of the piping system
			5. Not Properly Vacuumed Refrigerant Lines, which leads to air and humidity mixed with refrigerant.	Abnormal Refrigerant Pressure, and Higher current draw.	Re-Vacuum Refrigerant Lines and Re-charge system with refrigerant
			6. The electronic expansion valve is broken, resulting too high pressure	Low pressure is low and high pressure is high	Replace electronic expansion valve
			7. Fouling of the water side heat exchanger causes high pressure	Small temperature difference between inlet and outlet water, high pressure	Clean the water side heat exchanger and add water for treatment
			8. The high pressure switch is broken	If the pressure of the pressure gauge does	Replace the high pressure switch
			9. The hot water probe or space heating/cooling probes are not placed in their corresponding thermal wells	The outlet water temperature is very high, above 60 degrees Celcius	Place each probe in its thermal well
AL130	AL130 Disc.temp.probe error	Discharge gas temp. probe failure	1. Loose wire / broken wire / broken probe	Visual inspection	Tighten the wire/reconnect the wire/replace the probe
AL131	AL131 Suct.temp.probe error	Suction gas temp. probe failure	1. Loose wire / broken wire / broken probe	Visual inspection	Tighten the wire/reconnect the wire/replace the probe
AL134	AL134 Tank temp.probe error	Water tank probe failure	1. Loose wire / broken wire / broken probe	Visual inspection	Tighten the wire/reconnect the wire/replace the probe
AL138	AL138 High temp. alarm	Too high outlet water temperature protection	1. Strainer is blocked, resulting in a small water flow	The outlet water temperature is higher than 62 degrees Celcius	Clean the Strainer
			2. The water pump is too small, resulting in low water flow	The outlet water temperature is higher than 62 degrees Celcius	Replace the water pump with a larger water head and water flow
			3. The water pump is not empty, resulting in a small water flow	The outlet water temperature is higher than 62 degrees Celcius	Purge Water Pump
			4. There is air in the pipeline, which leads to poor water flow	The outlet water temperature is higher than 62 degrees	Install an automatic air vent at the highest point of the piping system
			5. The setting temperature is too high and the water flow is too small	The outlet water temperature is higher than 62 degrees	Decrease temperature setpoint
			1. Strainer is blocked, resulting in increased friction loss and a smaller water flow	The outlet water temperature is below 5 degrees Celcius	Clean the Strainer

Fault code	Panel description	Detail description	Possible cause	Diagnostics method	What to do?
AL139	AL139 Low temp. alarm	Too low outlet water temperature protection	2. The water pump is too small, resulting in low water flow	The outlet water temperature is below 5 degrees Celcius	Replace the water pump with a larger water head and water flow
			3. The water pump has air pockets (either in the impeller or in the piping around it)	The outlet water temperature is below 5 degrees Celcius	Purge water pump
			4. There is air in the pipeline, which leads to poor water flow	The outlet water temperature is below 5 degrees Celcius	Install an automatic air vent at the highest point of the piping system
AL153	AL153 Fan1 fault	Speed control fan 1 failure	1. The fan driver dial switch is abnormal	Visual inspection	Fan dial switch top-left-below-right
AL154	AL154 Fan2 fault	Speed control fan 2 failure	2. The fan inverter board is broken	Visually check that the power light is not on	Replace the fan inverter board
AL155	AL155 Fans Offline	Speed control fan	3. The fan motor is broken	Manual rotation of fan motor, still stuck	Replace the fan motor

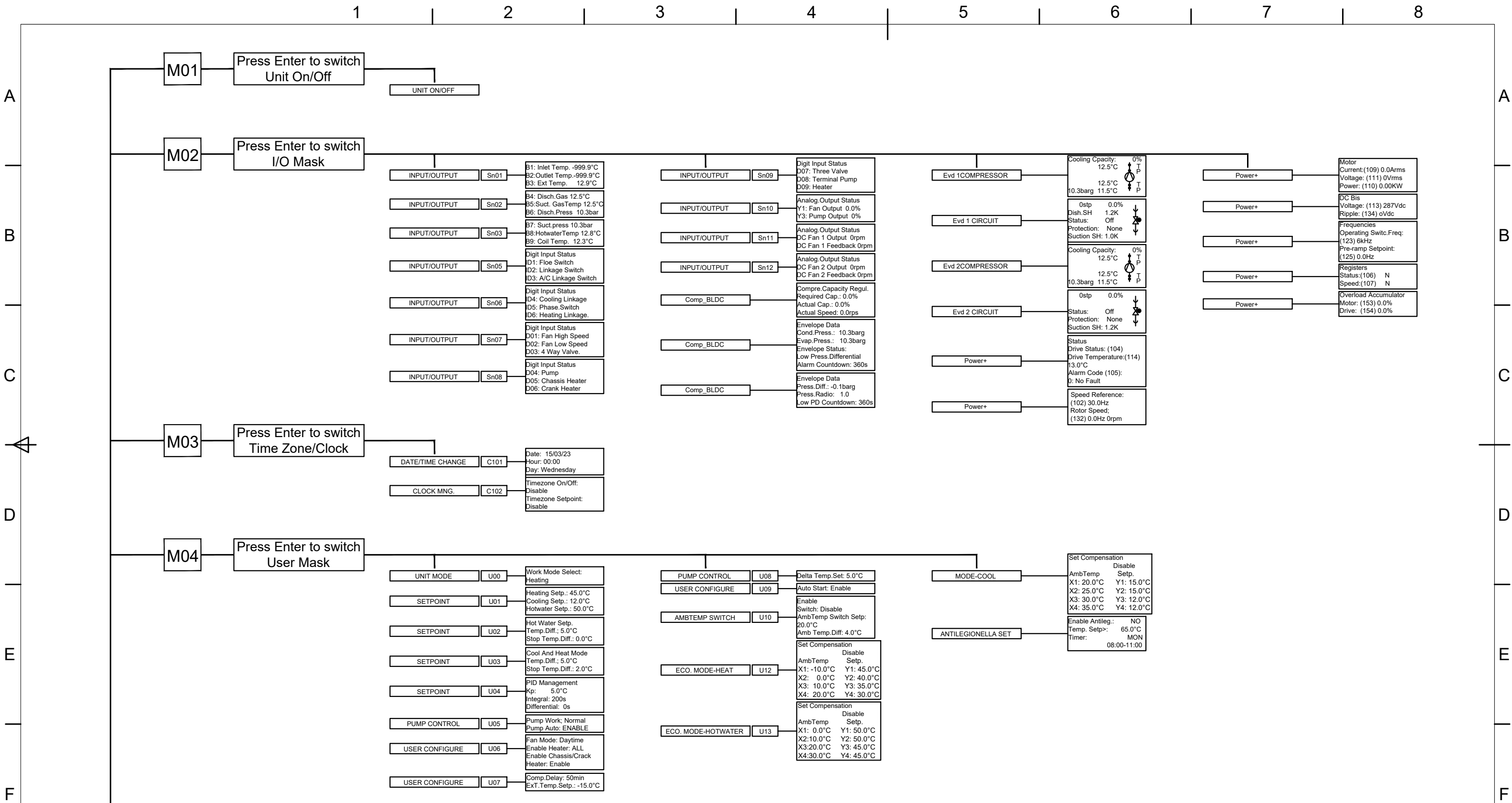

Ref. #	P/N				
Designed by IAN	Checked by ROGER	Approved by - date 2023-03-17	File name HSS306080CTRL	Date 2022-09-23	Scale NTS

This drawing is the property of AQUA SOLANOR INC. It may not be used for any purpose other than the owner. AQUA SOLANOR INC does not authorize the reproduction or conveyance of any information contained herein without prior written permission. This document is neither an engineering document, nor a construction document. Such documents shall be produced in compliance with federal, provincial or municipal laws. The purpose of this document is to show the principle of operation of equipment.

AQUA SOLANOR
2305 46th AVENUE, LACHINE (QC) H8T3C9

ANNEX "C" _01		
DWG.NO.:HSS306080CTRL	Revision 0	Sheet 1

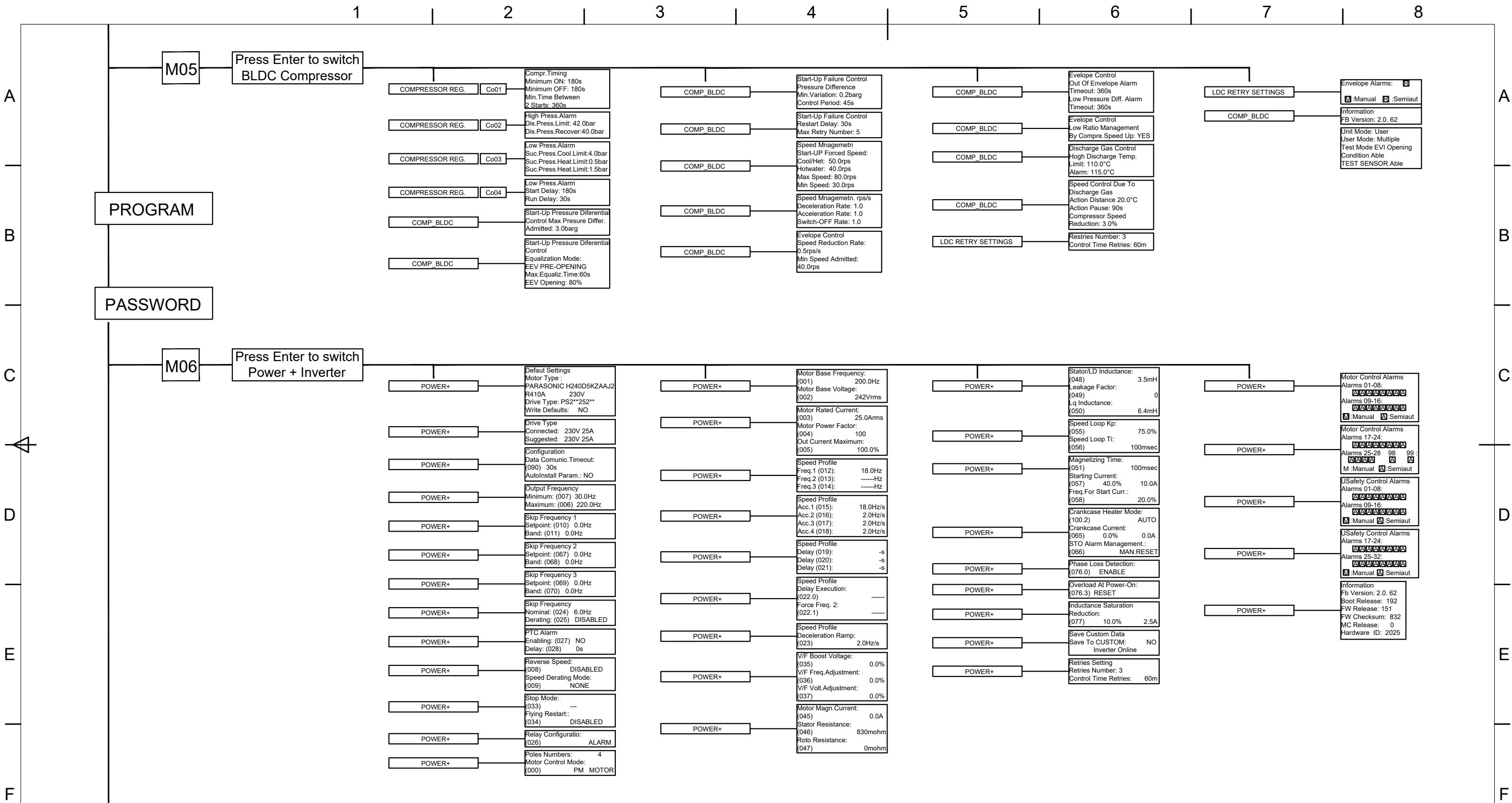

Ref. #	P/N				
Designed by IAN	Checked by ROGER	Approved by - date 2023-03-17	File name HSS306080CTRL	Date 2022-09-23	Scale NTS

This drawing is the property of AQUA SOLANOR INC. It may not be used for any purpose other than the owner. AQUA SOLANOR INC does not authorize the reproduction or conveyance of any information contained herein without prior written permission. This document is neither an engineering document, nor a construction document. Such documents shall be produced in compliance with federal, provincial or municipal laws. The purpose of this document is to show the principle of operation of equipment.

AQUA SOLANOR
2305 46th AVENUE, LACHINE (QC) H8T3C9

ANNEX "C" _02		
DWG.NO.:HSS306080CTRL	Revision 0	Sheet 2

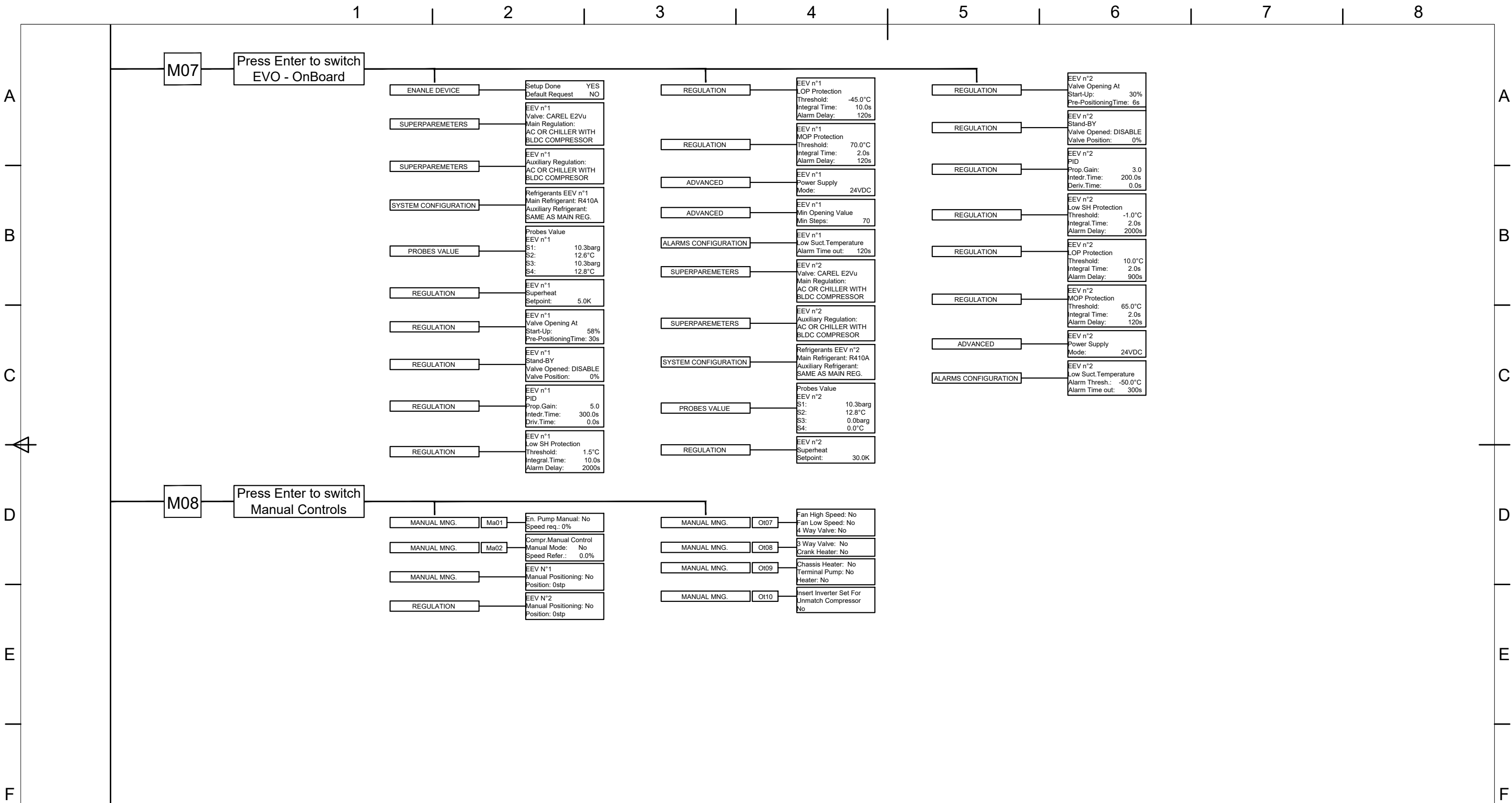

Ref. #	P/N				
Designed by IAN	Checked by ROGER	Approved by - date 2023-03-17	File name HSS306080CTRL	Date 2022-09-23	Scale NTS

This drawing is the property of AQUA SOLANOR INC. It may not be used for any purpose other than the owner. AQUA SOLANOR INC does not authorize the reproduction or conveyance of any information contained herein without prior written permission. This document is neither an engineering document, nor a construction document. Such documents shall be produced in compliance with federal, provincial or municipal laws. The purpose of this document is to show the principle of operation of equipment.

AQUA SOLANOR
2305 46th AVENUE, LACHINE (QC) H8T3C9

ANNEX "C" _03		
DWG.NO.:HSS306080CTRL	Revision 0	Sheet 3

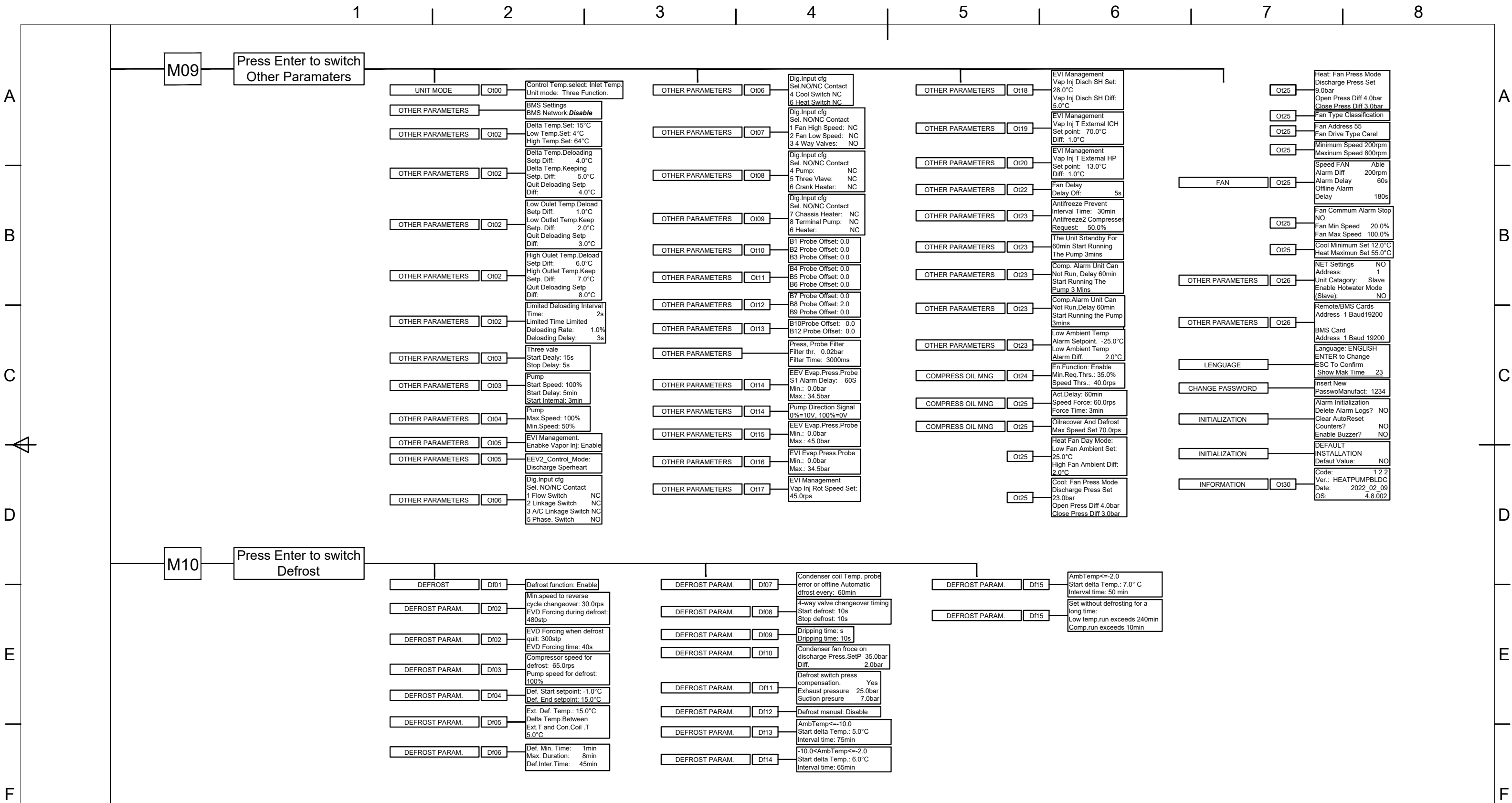

Ref. #	P/N				
Designed by IAN	Checked by ROGER	Approved by - date 2023-03-17	File name HSS306080CTRL	Date 2022-09-23	Scale NTS

This drawing is the property of AQUA SOLANOR INC. It may not be used for any purpose other than the owner. AQUA SOLANOR INC does not authorize the reproduction or conveyance of any information contained herein without prior written permission. This document is neither an engineering document, nor a construction document. Such documents shall be produced in compliance with federal, provincial or municipal laws. The purpose of this document is to show the principle of operation of equipment.

AQUA SOLANOR
2305 46th AVENUE, LACHINE (QC) H8T3C9

ANNEX "C" _04		
DWG.NO.:HSS306080CTRL	Revision 0	Sheet 4

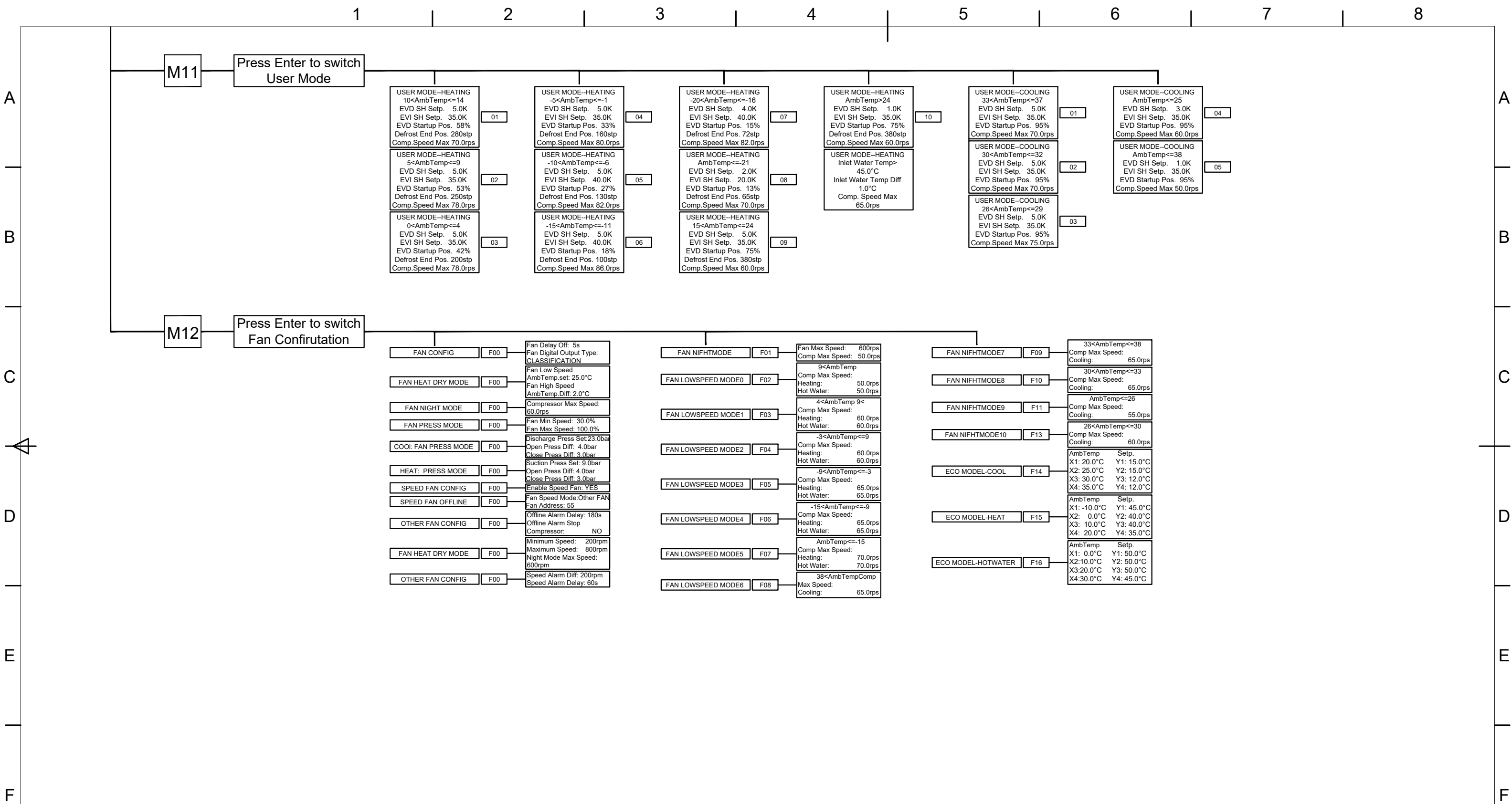

Ref. #	P/N				
Designed by IAN	Checked by ROGER	Approved by - date 2023-03-17	File name HSS306080CTRL	Date 2022-09-23	Scale NTS

This drawing is the property of AQUA SOLANOR INC. It may not be used for any purpose other than the owner. AQUA SOLANOR INC does not authorize the reproduction or conveyance of any information contained herein without prior written permission. This document is neither an engineering document, nor a construction document. Such documents shall be produced in compliance with federal, provincial or municipal laws. The purpose of this document is to show the principle of operation of equipment.

AQUA SOLANOR
2305 46th AVENUE, LACHINE (QC) H8T3C9

ANNEX "C" _05		
DWG.NO.:HSS306080CTRL	Revision 0	Sheet 5



Annex "D" - ATW Heat Pumps Performance in DWH Mode

HSS030V2LS with 100L Tank

Tank Volume (Liter)	100	Difference between energy supplied by heat pump at various outdoor air temperatures and energy required to heat DCW (from various Entering Domestic Cold-Water Temperatures up to DHW Minimum Temperature)								
DHW Flow (GPM)	2.5	Entering Domestic Cold Water °C / °F								
DHW Tank Temp. (°F)	131	1.67	4.45	7.23	10	12.78	15.56	18.34	21.12	
DHW Temp. Min (°F)	110	35	40	45	50	55	60	65	70	
Outdoor Dry Bulb Temperature °C / °F	-25	-13	(81,569)	(75,319)	(69,069)	(62,819)	(56,569)	(50,319)	(44,069)	(37,819)
	-20	-4	(78,226)	(71,976)	(65,726)	(59,476)	(53,226)	(46,976)	(40,726)	(34,476)
	-15	5	(74,507)	(68,257)	(62,007)	(55,757)	(49,507)	(43,257)	(37,007)	(30,757)
	-7	19.4	(70,720)	(64,470)	(58,220)	(51,970)	(45,720)	(39,470)	(33,220)	(26,970)
	2	35.6	(68,570)	(62,320)	(56,070)	(49,820)	(43,570)	(37,320)	(31,070)	(24,820)
	7	44.6	(60,382)	(54,132)	(47,882)	(41,632)	(35,382)	(29,132)	(22,882)	(16,632)
	12	53.6	(58,779)	(52,529)	(46,279)	(40,029)	(33,779)	(27,529)	(21,279)	(15,029)
	20	68	(57,619)	(51,369)	(45,119)	(38,869)	(32,619)	(26,369)	(20,119)	(13,869)
	23	73.4	(57,482)	(51,232)	(44,982)	(38,732)	(32,482)	(26,232)	(19,982)	(13,732)
	26	78.8	(57,346)	(51,096)	(44,846)	(38,596)	(32,346)	(26,096)	(19,846)	(13,596)
	29	84.2	(57,209)	(50,959)	(44,709)	(38,459)	(32,209)	(25,959)	(19,709)	(13,459)
	32	89.6	(56,970)	(50,720)	(44,470)	(38,220)	(31,970)	(25,720)	(19,470)	(13,220)
35	95	(57,175)	(50,925)	(44,675)	(38,425)	(32,175)	(25,925)	(19,675)	(13,425)	

Tank Volume (Liter)	100	Time in Minutes for the Tank's temperature to drop by 21°F (11.67°C)								
DHW Flow (GPM)	2.5	Entering Domestic Cold Water °C / °F								
DHW Tank Temp. (°F)	131	1.67	4.45	7.23	10	12.78	15.56	18.34	21.12	
DHW Temp. Min (°F)	110	35	40	45	50	55	60	65	70	
Outdoor Dry Bulb Temperature °C / °F	-25	-13	3.34	3.62	3.94	4.34	4.81	5.41	6.18	7.20
	-20	-4	3.48	3.78	4.14	4.58	5.12	5.80	6.68	7.90
	-15	5	3.66	3.99	4.39	4.88	5.50	6.29	7.36	8.85
	-7	19.4	3.85	4.22	4.68	5.24	5.96	6.90	8.19	10.09
	2	35.6	3.97	4.37	4.86	5.47	6.25	7.29	8.76	10.97
	7	44.6	4.51	5.03	5.69	6.54	7.69	9.34	11.89	16.36
	12	53.6	4.63	5.18	5.88	6.80	8.06	9.89	12.79	18.11
	20	68	4.73	5.30	6.03	7.00	8.34	10.32	13.53	19.62
	23	73.4	4.74	5.31	6.05	7.03	8.38	10.38	13.62	19.82
	26	78.8	4.75	5.33	6.07	7.05	8.42	10.43	13.71	20.01
	29	84.2	4.76	5.34	6.09	7.08	8.45	10.48	13.81	20.22
	32	89.6	4.78	5.37	6.12	7.12	8.51	10.58	13.98	20.58
35	95	4.76	5.35	6.09	7.08	8.46	10.50	13.83	20.27	



Annex "D" - ATW Heat Pumps Performance in DWH Mode

Tank Volume (Liter)	100		Volume of DHW in Liter extracted from the tank until it reaches the tank Min Temp.							
DHW Flow (GPM)	2.5		Entering Domestic Cold Water °C / °F							
DHW Tank Temp. (°F)	131		1.67	4.45	7.23	10	12.78	15.56	18.34	21.12
DHW Temp. Min (°F)	110		35	40	45	50	55	60	65	70
Outdoor Dry Bulb Temperature °C / °F	-25	-13	31.56	34.21	37.23	41.01	45.45	51.12	58.40	68.04
	-20	-4	32.89	35.72	39.12	43.28	48.38	54.81	63.13	74.66
	-15	5	34.59	37.71	41.49	46.12	51.98	59.44	69.55	83.63
	-7	19.4	36.38	39.88	44.23	49.52	56.32	65.21	77.40	95.35
	2	35.6	37.52	41.30	45.93	51.69	59.06	68.89	82.78	103.67
	7	44.6	42.62	47.53	53.77	61.80	72.67	88.26	112.36	154.60
	12	53.6	43.75	48.95	55.57	64.26	76.17	93.46	120.87	171.14
	20	68	44.70	50.09	56.98	66.15	78.81	97.52	127.86	185.41
	23	73.4	44.79	50.18	57.17	66.43	79.19	98.09	128.71	187.30
	26	78.8	44.89	50.37	57.36	66.62	79.57	98.56	129.56	189.09
	29	84.2	44.98	50.46	57.55	66.91	79.85	99.04	130.50	191.08
	32	89.6	45.17	50.75	57.83	67.28	80.42	99.98	132.11	194.48
35	95	44.98	50.56	57.55	66.91	79.95	99.23	130.69	191.55	

Tank Volume (Liter)	100		Tank's Temperature Recovery Time in Minutes from various Entering Domestic Cold-Water Temperatures to Maximum Temperature Set Point (131°F)							
DHW Flow (GPM)	2.5		Entering Domestic Cold Water °C / °F							
DHW Tank Temp. (°F)	131		1.67	4.45	7.23	10	12.78	15.56	18.34	21.12
DHW Temp. Min (°F)	110		35	40	45	50	55	60	65	70
Outdoor Dry Bulb Temperature °C / °F	-25	-13	102.10	96.78	91.46	86.15	80.83	75.51	70.19	64.88
	-20	-4	80.11	75.94	71.77	67.60	63.42	59.25	55.08	50.91
	-15	5	64.63	61.26	57.90	54.53	51.17	47.80	44.43	41.07
	-7	19.4	54.00	51.19	48.38	45.57	42.75	39.94	37.13	34.32
	2	35.6	49.39	46.82	44.25	41.68	39.10	36.53	33.96	31.39
	7	44.6	37.27	35.33	33.39	31.45	29.51	27.57	25.63	23.69
	12	53.6	35.57	33.71	31.86	30.01	28.16	26.30	24.45	22.60
	20	68	34.42	32.63	30.84	29.05	27.25	25.46	23.67	21.88
	23	73.4	34.29	32.51	30.72	28.94	27.15	25.36	23.58	21.79
	26	78.8	34.17	32.39	30.61	28.83	27.05	25.27	23.49	21.71
	29	84.2	34.04	32.27	30.49	28.72	26.95	25.17	23.40	21.63
	32	89.6	33.82	32.06	30.29	28.53	26.77	25.01	23.25	21.49
35	95	34.01	32.24	30.46	28.69	26.92	25.15	23.38	21.61	



Annex "D" - ATW Heat Pumps Performance in DWH Mode

HSS030V2LS with 200L Tank

Tank Volume (Liter)	200	Difference between energy supplied by heat pump at various outdoor air temperatures and energy required to heat DCW (from various Entering Domestic Cold-Water Temperatures up to DHW Minimum Temperature)								
DHW Flow (GPM)	2.5	Entering Domestic Cold Water °C / °F								
DHW Tank Temp. (°F)	131	1.67	4.45	7.23	10	12.78	15.56	18.34	21.12	
DHW Temp. Min (°F)	110	35	40	45	50	55	60	65	70	
Outdoor Dry Bulb Temperature °C / °F	-25	-13	(81,569)	(75,319)	(69,069)	(62,819)	(56,569)	(50,319)	(44,069)	(37,819)
	-20	-4	(78,226)	(71,976)	(65,726)	(59,476)	(53,226)	(46,976)	(40,726)	(34,476)
	-15	5	(74,507)	(68,257)	(62,007)	(55,757)	(49,507)	(43,257)	(37,007)	(30,757)
	-7	19.4	(70,720)	(64,470)	(58,220)	(51,970)	(45,720)	(39,470)	(33,220)	(26,970)
	2	35.6	(68,570)	(62,320)	(56,070)	(49,820)	(43,570)	(37,320)	(31,070)	(24,820)
	7	44.6	(60,382)	(54,132)	(47,882)	(41,632)	(35,382)	(29,132)	(22,882)	(16,632)
	12	53.6	(58,779)	(52,529)	(46,279)	(40,029)	(33,779)	(27,529)	(21,279)	(15,029)
	20	68	(57,619)	(51,369)	(45,119)	(38,869)	(32,619)	(26,369)	(20,119)	(13,869)
	23	73.4	(57,482)	(51,232)	(44,982)	(38,732)	(32,482)	(26,232)	(19,982)	(13,732)
	26	78.8	(57,346)	(51,096)	(44,846)	(38,596)	(32,346)	(26,096)	(19,846)	(13,596)
	29	84.2	(57,209)	(50,959)	(44,709)	(38,459)	(32,209)	(25,959)	(19,709)	(13,459)
	32	89.6	(56,970)	(50,720)	(44,470)	(38,220)	(31,970)	(25,720)	(19,470)	(13,220)
35	95	(57,175)	(50,925)	(44,675)	(38,425)	(32,175)	(25,925)	(19,675)	(13,425)	

Tank Volume (Liter)	200	Time in Minutes for the Tank's temperature to drop by 21°F (11.67°C)								
DHW Flow (GPM)	2.5	Entering Domestic Cold Water °C / °F								
DHW Tank Temp. (°F)	131	1.67	4.45	7.23	10	12.78	15.56	18.34	21.12	
DHW Temp. Min (°F)	110	35	40	45	50	55	60	65	70	
Outdoor Dry Bulb Temperature °C / °F	-25	-13	6.68	7.23	7.88	8.67	9.62	10.82	12.35	14.39
	-20	-4	6.96	7.56	8.28	9.15	10.23	11.59	13.36	15.79
	-15	5	7.31	7.98	8.78	9.76	10.99	12.58	14.71	17.69
	-7	19.4	7.70	8.44	9.35	10.47	11.91	13.79	16.38	20.18
	2	35.6	7.94	8.74	9.71	10.93	12.49	14.58	17.52	21.93
	7	44.6	9.02	10.06	11.37	13.07	15.38	18.68	23.78	32.72
	12	53.6	9.26	10.36	11.76	13.60	16.11	19.77	25.57	36.21
	20	68	9.45	10.60	12.06	14.00	16.68	20.64	27.05	39.23
	23	73.4	9.47	10.62	12.10	14.05	16.75	20.75	27.23	39.63
	26	78.8	9.49	10.65	12.14	14.10	16.83	20.85	27.42	40.02
	29	84.2	9.52	10.68	12.17	14.15	16.90	20.96	27.61	40.43
	32	89.6	9.56	10.73	12.24	14.24	17.02	21.16	27.95	41.16
35	95	9.52	10.69	12.18	14.16	16.91	20.99	27.66	40.53	



Annex "D" - ATW Heat Pumps Performance in DWH Mode

Tank Volume (Liter)		Volume of DHW in Liter extracted from the tank until it reaches the tank Min Temp.								
200										
DHW Flow (GPM)		Entering Domestic Cold Water °C / °F								
2.5										
DHW Tank Temp. (°F)		1.67	4.45	7.23	10	12.78	15.56	18.34	21.12	
131										
DHW Temp. Min (°F)		35	40	45	50	55	60	65	70	
110										
Outdoor Dry Bulb Temperature °C / °F	-25	-13	63.13	68.32	74.47	81.93	90.91	102.25	116.71	135.99
	-20	-4	65.77	71.44	78.25	86.47	96.67	109.53	126.25	149.22
	-15	5	69.08	75.41	82.97	92.23	103.86	118.88	139.01	167.17
	-7	19.4	72.77	79.76	88.36	98.94	112.55	130.32	154.79	190.70
	2	35.6	75.03	82.59	91.76	103.29	118.03	137.78	165.56	207.24
	7	44.6	85.24	95.07	107.45	123.51	145.34	176.53	224.72	309.20
	12	53.6	87.51	97.90	111.13	128.52	152.24	186.83	241.64	342.18
	20	68	89.30	100.17	113.97	132.30	157.63	195.05	255.62	370.72
	23	73.4	89.49	100.36	114.35	132.77	158.29	196.09	257.32	374.50
	26	78.8	89.68	100.64	114.72	133.25	159.04	197.03	259.12	378.19
	29	84.2	89.96	100.93	115.01	133.72	159.71	198.07	260.91	382.06
	32	89.6	90.34	101.40	115.67	134.57	160.84	199.96	264.13	388.96
35	95	89.96	101.02	115.10	133.81	159.80	198.36	261.39	383.01	

Tank Volume (Liter)		Tank's Temperature Recovery Time in Minutes from various Entering Domestic Cold-Water Temperatures to Maximum Temperature Set Point (131°F)								
200										
DHW Flow (GPM)		Entering Domestic Cold Water °C / °F								
2.5										
DHW Tank Temp. (°F)		1.67	4.45	7.23	10	12.78	15.56	18.34	21.12	
131										
DHW Temp. Min (°F)		35	40	45	50	55	60	65	70	
110										
Outdoor Dry Bulb Temperature °C / °F	-25	-13	204.19	193.56	182.92	172.29	161.65	151.02	140.38	129.75
	-20	-4	160.22	151.88	143.53	135.19	126.84	118.50	110.15	101.81
	-15	5	129.26	122.52	115.79	109.06	102.33	95.60	88.86	82.13
	-7	19.4	108.00	102.38	96.75	91.13	85.50	79.88	74.25	68.63
	2	35.6	98.78	93.64	88.49	83.35	78.20	73.06	67.91	62.77
	7	44.6	74.54	70.66	66.78	62.90	59.01	55.13	51.25	47.37
	12	53.6	71.13	67.42	63.72	60.01	56.31	52.60	48.90	45.20
	20	68	68.84	65.26	61.67	58.09	54.50	50.92	47.33	43.75
	23	73.4	68.58	65.01	61.44	57.87	54.30	50.72	47.15	43.58
	26	78.8	68.33	64.77	61.21	57.65	54.09	50.53	46.98	43.42
	29	84.2	68.07	64.53	60.98	57.44	53.89	50.34	46.80	43.25
	32	89.6	67.63	64.11	60.58	57.06	53.54	50.02	46.50	42.97
35	95	68.01	64.47	60.92	57.38	53.84	50.30	46.76	43.21	



Annex "D" - ATW Heat Pumps Performance in DWH Mode

HSS030V2LS with 300L Tank

Tank Volume (Liter)	300	Difference between energy supplied by heat pump at various outdoor air temperatures and energy required to heat DCW (from various Entering Domestic Cold-Water Temperatures up to DHW Minimum Temperature)								
DHW Flow (GPM)	2.5	Entering Domestic Cold Water °C / °F								
DHW Tank Temp. (°F)	131	1.67	4.45	7.23	10	12.78	15.56	18.34	21.12	
DHW Temp. Min (°F)	110	35	40	45	50	55	60	65	70	
Outdoor Dry Bulb Temperature °C / °F	-25	-13	-81,569	-75,319	-69,069	-62,819	-56,569	-50,319	-44,069	-37,819
	-20	-4	-78,226	-71,976	-65,726	-59,476	-53,226	-46,976	-40,726	-34,476
	-15	5	-74,507	-68,257	-62,007	-55,757	-49,507	-43,257	-37,007	-30,757
	-7	19.4	-70,720	-64,470	-58,220	-51,970	-45,720	-39,470	-33,220	-26,970
	2	35.6	-68,570	-62,320	-56,070	-49,820	-43,570	-37,320	-31,070	-24,820
	7	44.6	-60,382	-54,132	-47,882	-41,632	-35,382	-29,132	-22,882	-16,632
	12	53.6	-58,779	-52,529	-46,279	-40,029	-33,779	-27,529	-21,279	-15,029
	20	68	-57,619	-51,369	-45,119	-38,869	-32,619	-26,369	-20,119	-13,869
	23	73.4	-57,482	-51,232	-44,982	-38,732	-32,482	-26,232	-19,982	-13,732
	26	78.8	-57,346	-51,096	-44,846	-38,596	-32,346	-26,096	-19,846	-13,596
	29	84.2	-57,209	-50,959	-44,709	-38,459	-32,209	-25,959	-19,709	-13,459
	32	89.6	-56,970	-50,720	-44,470	-38,220	-31,970	-25,720	-19,470	-13,220
35	95	-57,175	-50,925	-44,675	-38,425	-32,175	-25,925	-19,675	-13,425	

Tank Volume (Liter)	300	Time in Minutes for the Tank's temperature to drop by 21°F (11.67°C)								
DHW Flow (GPM)	2.5	Entering Domestic Cold Water °C / °F								
DHW Tank Temp. (°F)	131	1.67	4.45	7.23	10	12.78	15.56	18.34	21.12	
DHW Temp. Min (°F)	110	35	40	45	50	55	60	65	70	
Outdoor Dry Bulb Temperature °C / °F	-25	-13	10.01	10.84	11.82	13.00	14.43	16.22	18.52	21.58
	-20	-4	10.44	11.34	12.42	13.73	15.34	17.38	20.04	23.68
	-15	5	10.96	11.96	13.17	14.64	16.49	18.87	22.06	26.54
	-7	19.4	11.54	12.66	14.02	15.71	17.86	20.68	24.57	30.26
	2	35.6	11.91	13.10	14.56	16.39	18.74	21.87	26.27	32.89
	7	44.6	13.52	15.08	17.05	19.61	23.07	28.02	35.67	49.07
	12	53.6	13.89	15.54	17.64	20.39	24.17	29.65	38.36	54.31
	20	68	14.17	15.89	18.09	21.00	25.02	30.95	40.57	58.85
	23	73.4	14.20	15.93	18.15	21.08	25.13	31.12	40.85	59.44
	26	78.8	14.24	15.98	18.20	21.15	25.24	31.28	41.13	60.03
	29	84.2	14.27	16.02	18.26	21.23	25.34	31.44	41.41	60.64
	32	89.6	14.33	16.10	18.36	21.36	25.53	31.74	41.92	61.74
35	95	14.28	16.03	18.27	21.24	25.37	31.48	41.48	60.79	



Annex “D” - ATW Heat Pumps Performance in DWH Mode

Tank Volume (Liter)	300	Volume of DHW in Liter extracted from the tank until it reaches the tank Min Temp.								
DHW Flow (GPM)	2.5	Entering Domestic Cold Water °C / °F								
DHW Tank Temp. (°F)	131	1.67	4.45	7.23	10	12.78	15.56	18.34	21.12	
DHW Temp. Min (°F)	110	35	40	45	50	55	60	65	70	
Outdoor Dry Bulb Temperature °C / °F	-25	-13	94.59	102.44	111.70	122.85	136.36	153.28	175.01	203.93
	-20	-4	98.66	107.16	117.37	129.75	144.96	164.24	189.38	223.78
	-15	5	103.57	113.02	124.46	138.35	155.83	178.32	208.47	250.80
	-7	19.4	109.05	119.64	132.49	148.46	168.78	195.43	232.19	285.96
	2	35.6	112.55	123.80	137.59	154.89	177.09	206.67	248.25	310.81
	7	44.6	127.76	142.51	161.12	185.31	218.01	264.79	337.08	463.71
	12	53.6	131.26	146.85	166.70	192.69	228.41	280.19	362.50	513.23
	20	68	133.91	150.16	170.95	198.45	236.44	292.48	383.39	556.13
	23	73.4	134.19	150.54	171.52	199.21	237.48	294.08	386.03	561.71
	26	78.8	134.57	151.01	171.99	199.87	238.52	295.60	388.68	567.28
	29	84.2	134.85	151.39	172.56	200.62	239.46	297.11	391.32	573.05
	32	89.6	135.42	152.15	173.50	201.85	241.26	299.94	396.14	583.44
35	95	134.95	151.48	172.65	200.72	239.75	297.49	391.99	574.47	

Tank Volume (Liter)	300	Tank's Temperature Recovery Time in Minutes from various Entering Domestic Cold-Water Temperatures to Maximum Temperature Set Point (131°F)								
DHW Flow (GPM)	2.5	Entering Domestic Cold Water °C / °F								
DHW Tank Temp. (°F)	131	1.67	4.45	7.23	10	12.78	15.56	18.34	21.12	
DHW Temp. Min (°F)	110	35	40	45	50	55	60	65	70	
Outdoor Dry Bulb Temperature °C / °F	-25	-13	306.28	290.33	274.38	258.43	242.47	226.52	210.57	194.62
	-20	-4	240.33	227.81	215.29	202.78	190.26	177.74	165.23	152.71
	-15	5	193.88	183.78	173.69	163.59	153.49	143.39	133.29	123.20
	-7	19.4	162.00	153.56	145.13	136.69	128.25	119.81	111.38	102.94
	2	35.6	148.17	140.45	132.73	125.02	117.30	109.58	101.87	94.15
	7	44.6	111.81	105.99	100.17	94.34	88.52	82.70	76.87	71.05
	12	53.6	106.69	101.13	95.57	90.02	84.46	78.90	73.35	67.79
	20	68	103.26	97.88	92.51	87.13	81.75	76.37	70.99	65.62
	23	73.4	102.87	97.51	92.16	86.80	81.44	76.08	70.73	65.37
	26	78.8	102.49	97.15	91.81	86.47	81.14	75.80	70.46	65.12
	29	84.2	102.10	96.79	91.47	86.15	80.83	75.51	70.20	64.88
	32	89.6	101.44	96.16	90.87	85.59	80.31	75.02	69.74	64.46
35	95	102.01	96.70	91.38	86.07	80.76	75.44	70.13	64.82	



Annex "D" - ATW Heat Pumps Performance in DWH Mode

HSS030V2LS with 400L Tank

Tank Volume (Liter)	400	Difference between energy supplied by heat pump at various outdoor air temperatures and energy required to heat DCW (from various Entering Domestic Cold-Water Temperatures up to DHW Minimum Temperature)								
DHW Flow (GPM)	2.5	Entering Domestic Cold Water °C / °F								
DHW Tank Temp. (°F)	131	1.67	4.45	7.23	10	12.78	15.56	18.34	21.12	
DHW Temp. Min (°F)	110	35	40	45	50	55	60	65	70	
Outdoor Dry Bulb Temperature °C / °F	-25	-13	-81,569	-75,319	-69,069	-62,819	-56,569	-50,319	-44,069	-37,819
	-20	-4	-78,226	-71,976	-65,726	-59,476	-53,226	-46,976	-40,726	-34,476
	-15	5	-74,507	-68,257	-62,007	-55,757	-49,507	-43,257	-37,007	-30,757
	-7	19.4	-70,720	-64,470	-58,220	-51,970	-45,720	-39,470	-33,220	-26,970
	2	35.6	-68,570	-62,320	-56,070	-49,820	-43,570	-37,320	-31,070	-24,820
	7	44.6	-60,382	-54,132	-47,882	-41,632	-35,382	-29,132	-22,882	-16,632
	12	53.6	-58,779	-52,529	-46,279	-40,029	-33,779	-27,529	-21,279	-15,029
	20	68	-57,619	-51,369	-45,119	-38,869	-32,619	-26,369	-20,119	-13,869
	23	73.4	-57,482	-51,232	-44,982	-38,732	-32,482	-26,232	-19,982	-13,732
	26	78.8	-57,346	-51,096	-44,846	-38,596	-32,346	-26,096	-19,846	-13,596
	29	84.2	-57,209	-50,959	-44,709	-38,459	-32,209	-25,959	-19,709	-13,459
	32	89.6	-56,970	-50,720	-44,470	-38,220	-31,970	-25,720	-19,470	-13,220
35	95	-57,175	-50,925	-44,675	-38,425	-32,175	-25,925	-19,675	-13,425	

Tank Volume (Liter)	400	Time in Minutes for the Tank's temperature to drop by 21°F (11.67°C)								
DHW Flow (GPM)	2.5	Entering Domestic Cold Water °C / °F								
DHW Tank Temp. (°F)	131	1.67	4.45	7.23	10	12.78	15.56	18.34	21.12	
DHW Temp. Min (°F)	110	35	40	45	50	55	60	65	70	
Outdoor Dry Bulb Temperature °C / °F	-25	-13	13.35	14.45	15.76	17.33	19.24	21.63	24.70	28.78
	-20	-4	13.92	15.12	16.56	18.30	20.45	23.17	26.72	31.57
	-15	5	14.61	15.95	17.55	19.52	21.98	25.16	29.41	35.38
	-7	19.4	15.39	16.88	18.70	20.94	23.81	27.57	32.76	40.35
	2	35.6	15.87	17.47	19.41	21.85	24.98	29.16	35.03	43.85
	7	44.6	18.03	20.11	22.73	26.14	30.76	37.36	47.56	65.43
	12	53.6	18.52	20.72	23.52	27.19	32.22	39.53	51.14	72.41
	20	68	18.89	21.19	24.12	28.00	33.36	41.27	54.09	78.46
	23	73.4	18.94	21.24	24.20	28.10	33.50	41.49	54.46	79.25
	26	78.8	18.98	21.30	24.27	28.20	33.65	41.70	54.83	80.04
	29	84.2	19.03	21.36	24.34	28.30	33.79	41.92	55.22	80.85
	32	89.6	19.11	21.46	24.47	28.48	34.04	42.31	55.89	82.32
35	95	19.04	21.37	24.36	28.32	33.82	41.98	55.31	81.06	



Annex "D" - ATW Heat Pumps Performance in DWH Mode

Tank Volume (Liter)	400	Volume of DHW in Liter extracted from the tank until it reaches the tank Min Temp.								
DHW Flow (GPM)	2.5	Entering Domestic Cold Water °C / °F								
DHW Tank Temp. (°F)	131	1.67	4.45	7.23	10	12.78	15.56	18.34	21.12	
DHW Temp. Min (°F)	110	35	40	45	50	55	60	65	70	
Outdoor Dry Bulb Temperature °C / °F	-25	-13	126.16	136.55	148.93	163.77	181.82	204.40	233.42	271.97
	-20	-4	131.54	142.88	156.49	172.94	193.25	218.96	252.50	298.34
	-15	5	138.06	150.73	165.85	184.46	207.71	237.76	277.92	334.34
	-7	19.4	145.44	159.52	176.72	197.88	225.00	260.54	309.58	381.31
	2	35.6	149.97	165.09	183.42	206.48	236.06	275.56	331.03	414.38
	7	44.6	170.38	190.04	214.80	247.02	290.68	353.05	449.44	618.31
	12	53.6	175.01	195.80	222.26	256.95	304.48	373.56	483.27	684.27
	20	68	178.51	200.25	227.93	264.60	315.25	390.00	511.15	741.45
	23	73.4	178.98	200.72	228.69	265.55	316.58	392.08	514.65	748.91
	26	78.8	179.36	201.29	229.35	266.49	317.99	394.07	518.14	756.38
	29	84.2	179.83	201.85	230.01	267.44	319.32	396.14	521.83	764.03
	32	89.6	180.59	202.80	231.24	269.14	321.68	399.83	528.16	777.92
35	95	179.93	201.95	230.20	267.62	319.60	396.71	522.68	766.02	

Tank Volume (Liter)	400	Tank's Temperature Recovery Time in Minutes from various Entering Domestic Cold-Water Temperatures to Maximum Temperature Set Point (131°F)								
DHW Flow (GPM)	2.5	Entering Domestic Cold Water °C / °F								
DHW Tank Temp. (°F)	131	1.67	4.45	7.23	10	12.78	15.56	18.34	21.12	
DHW Temp. Min (°F)	110	35	40	45	50	55	60	65	70	
Outdoor Dry Bulb Temperature °C / °F	-25	-13	408.37	387.11	365.84	344.57	323.30	302.03	280.76	259.49
	-20	-4	320.43	303.75	287.06	270.37	253.68	236.99	220.30	203.61
	-15	5	258.51	245.04	231.58	218.12	204.65	191.19	177.72	164.26
	-7	19.4	216.00	204.75	193.50	182.25	171.00	159.75	148.50	137.25
	2	35.6	197.56	187.27	176.98	166.69	156.40	146.11	135.82	125.53
	7	44.6	149.08	141.32	133.55	125.79	118.02	110.26	102.49	94.73
	12	53.6	142.25	134.84	127.43	120.02	112.61	105.20	97.80	90.39
	20	68	137.68	130.51	123.34	116.17	109.00	101.83	94.66	87.49
	23	73.4	137.16	130.02	122.87	115.73	108.59	101.44	94.30	87.16
	26	78.8	136.65	129.53	122.41	115.30	108.18	101.06	93.95	86.83
	29	84.2	136.14	129.05	121.96	114.87	107.78	100.68	93.59	86.50
	32	89.6	135.25	128.21	121.16	114.12	107.07	100.03	92.99	85.94
35	95	136.01	128.93	121.84	114.76	107.67	100.59	93.51	86.42	



Annex "D" - ATW Heat Pumps Performance in DWH Mode

HSS030V2LS with 500L Tank

Tank Volume (Liter)	500	Difference between energy supplied by heat pump at various outdoor air temperatures and energy required to heat DCW (from various Entering Domestic Cold-Water Temperatures up to DHW Minimum Temperature)								
DHW Flow (GPM)	2.5	Entering Domestic Cold Water °C / °F								
DHW Tank Temp. (°F)	131	1.67	4.45	7.23	10	12.78	15.56	18.34	21.12	
DHW Temp. Min (°F)	110	35	40	45	50	55	60	65	70	
Outdoor Dry Bulb Temperature °C / °F	-25	-13	-81,569	-75,319	-69,069	-62,819	-56,569	-50,319	-44,069	-37,819
	-20	-4	-78,226	-71,976	-65,726	-59,476	-53,226	-46,976	-40,726	-34,476
	-15	5	-74,507	-68,257	-62,007	-55,757	-49,507	-43,257	-37,007	-30,757
	-7	19.4	-70,720	-64,470	-58,220	-51,970	-45,720	-39,470	-33,220	-26,970
	2	35.6	-68,570	-62,320	-56,070	-49,820	-43,570	-37,320	-31,070	-24,820
	7	44.6	-60,382	-54,132	-47,882	-41,632	-35,382	-29,132	-22,882	-16,632
	12	53.6	-58,779	-52,529	-46,279	-40,029	-33,779	-27,529	-21,279	-15,029
	20	68	-57,619	-51,369	-45,119	-38,869	-32,619	-26,369	-20,119	-13,869
	23	73.4	-57,482	-51,232	-44,982	-38,732	-32,482	-26,232	-19,982	-13,732
	26	78.8	-57,346	-51,096	-44,846	-38,596	-32,346	-26,096	-19,846	-13,596
	29	84.2	-57,209	-50,959	-44,709	-38,459	-32,209	-25,959	-19,709	-13,459
	32	89.6	-56,970	-50,720	-44,470	-38,220	-31,970	-25,720	-19,470	-13,220
35	95	-57,175	-50,925	-44,675	-38,425	-32,175	-25,925	-19,675	-13,425	

Tank Volume (Liter)	500	Time in Minutes for the Tank's temperature to drop by 21°F (11.67°C)								
DHW Flow (GPM)	2.5	Entering Domestic Cold Water °C / °F								
DHW Tank Temp. (°F)	131	1.67	4.45	7.23	10	12.78	15.56	18.34	21.12	
DHW Temp. Min (°F)	110	35	40	45	50	55	60	65	70	
Outdoor Dry Bulb Temperature °C / °F	-25	-13	16.68	18.06	19.70	21.66	24.05	27.04	30.87	35.97
	-20	-4	17.39	18.90	20.70	22.87	25.56	28.96	33.40	39.46
	-15	5	18.26	19.93	21.94	24.40	27.48	31.45	36.76	44.23
	-7	19.4	19.24	21.10	23.37	26.18	29.76	34.47	40.95	50.44
	2	35.6	19.84	21.83	24.26	27.31	31.22	36.45	43.78	54.81
	7	44.6	22.53	25.13	28.41	32.68	38.45	46.70	59.45	81.79
	12	53.6	23.15	25.90	29.40	33.98	40.27	49.41	63.93	90.51
	20	68	23.61	26.48	30.15	35.00	41.70	51.59	67.61	98.08
	23	73.4	23.67	26.55	30.24	35.12	41.88	51.86	68.07	99.06
	26	78.8	23.72	26.62	30.33	35.25	42.06	52.13	68.54	100.05
	29	84.2	23.78	26.70	30.43	35.37	42.23	52.40	69.02	101.07
	32	89.6	23.88	26.82	30.59	35.59	42.55	52.89	69.86	102.89
35	95	23.79	26.71	30.45	35.40	42.28	52.47	69.14	101.32	



Annex "D" - ATW Heat Pumps Performance in DWH Mode

Tank Volume (Liter)	500	Volume of DHW in Liter extracted from the tank until it reaches the tank Min Temp.								
DHW Flow (GPM)	2.5	Entering Domestic Cold Water °C / °F								
DHW Tank Temp. (°F)	131	1.67	4.45	7.23	10	12.78	15.56	18.34	21.12	
DHW Temp. Min (°F)	110	35	40	45	50	55	60	65	70	
Outdoor Dry Bulb Temperature °C / °F	-25	-13	157.63	170.67	186.17	204.69	227.27	255.53	291.72	339.92
	-20	-4	164.34	178.61	195.62	216.12	241.54	273.67	315.63	372.90
	-15	5	172.56	188.34	207.33	230.58	259.69	297.20	347.38	417.97
	-7	19.4	181.82	199.40	220.85	247.40	281.23	325.74	386.98	476.66
	2	35.6	187.49	206.29	229.26	258.08	295.03	344.45	413.72	517.95
	7	44.6	212.91	237.48	268.47	308.83	363.35	441.32	561.80	772.92
	12	53.6	218.77	244.76	277.83	321.11	380.55	466.92	604.14	855.32
	20	68	223.11	250.24	284.92	330.75	394.07	487.53	638.91	926.86
	23	73.4	223.68	250.90	285.77	331.88	395.77	490.08	643.26	936.12
	26	78.8	224.15	251.56	286.62	333.11	397.47	492.63	647.70	945.47
	29	84.2	224.72	252.32	287.56	334.25	399.07	495.18	652.24	955.11
	32	89.6	225.67	253.45	289.08	336.33	402.10	499.81	660.18	972.31
35	95	224.82	252.41	287.75	334.53	399.55	495.84	653.37	957.47	

Tank Volume (Liter)	500	Tank's Temperature Recovery Time in Minutes from various Entering Domestic Cold-Water Temperatures to Maximum Temperature Set Point (131°F)								
DHW Flow (GPM)	2.5	Entering Domestic Cold Water °C / °F								
DHW Tank Temp. (°F)	131	1.67	4.45	7.23	10	12.78	15.56	18.34	21.12	
DHW Temp. Min (°F)	110	35	40	45	50	55	60	65	70	
Outdoor Dry Bulb Temperature °C / °F	-25	-13	510.47	483.88	457.29	430.71	404.12	377.53	350.95	324.36
	-20	-4	400.54	379.68	358.82	337.96	317.10	296.24	275.37	254.51
	-15	5	323.13	306.30	289.47	272.64	255.81	238.98	222.15	205.33
	-7	19.4	270.00	255.94	241.87	227.81	213.75	199.69	185.63	171.56
	2	35.6	246.94	234.08	221.22	208.36	195.50	182.64	169.78	156.91
	7	44.6	186.35	176.64	166.94	157.23	147.53	137.82	128.12	118.41
	12	53.6	177.81	168.55	159.29	150.03	140.77	131.50	122.24	112.98
	20	68	172.10	163.14	154.17	145.21	136.25	127.28	118.32	109.36
	23	73.4	171.45	162.52	153.59	144.66	135.73	126.80	117.87	108.94
	26	78.8	170.81	161.91	153.02	144.12	135.22	126.33	117.43	108.54
	29	84.2	170.17	161.31	152.44	143.58	134.72	125.85	116.99	108.13
	32	89.6	169.06	160.26	151.45	142.65	133.84	125.04	116.23	107.43
35	95	170.01	161.16	152.30	143.45	134.59	125.74	116.88	108.03	



Annex "D" - ATW Heat Pumps Performance in DWH Mode

HSS060V2LS with 100L Tank

Tank Volume (Litre)	100	Difference between energy supplied by heat pump at various outdoor air temperatures and energy required to heat DCW (from various Entering Domestic Cold Water Temperatures up to DHW Minimum Temperature)								
DHW Flow (GPM)	2.5	Entering Domestic Cold Water °C / °F								
DHW Tank Temp. (°F)	131	1.67	4.45	7.23	10	12.78	15.56	18.34	21.12	
DHW Temp. Min (°F)	110	35	40	45	50	55	60	65	70	
Outdoor Dry Bulb Temperature °C / °F	-25	-13	-66,285	-60,035	-53,785	-47,535	-41,285	-35,035	-28,785	-22,535
	-20	-4	-59,324	-53,074	-46,824	-40,574	-34,324	-28,074	-21,824	-15,574
	-15	5	-55,469	-49,219	-42,969	-36,719	-30,469	-24,219	-17,969	-11,719
	-7	19.4	-48,782	-42,532	-36,282	-30,032	-23,782	-17,532	-11,282	-5,032
	2	35.6	-45,575	-39,325	-33,075	-26,825	-20,575	-14,325	-8,075	-1,825
	7	44.6	-36,704	-30,454	-24,204	-17,954	-11,704	-5,454	796	7,046
	12	53.6	-34,487	-28,237	-21,987	-15,737	-9,487	-3,237	3,013	9,263
	20	68	-28,414	-22,164	-15,914	-9,664	-3,414	2,836	9,086	15,336
	23	73.4	-26,810	-20,560	-14,310	-8,060	-1,810	4,440	10,690	16,940
	26	78.8	-24,422	-18,172	-11,922	-5,672	578	6,828	13,078	19,328
	29	84.2	-21,215	-14,965	-8,715	-2,465	3,785	10,035	16,285	22,535
	32	89.6	-24,319	-18,069	-11,819	-5,569	681	6,931	13,181	19,431
35	95	-20,191	-13,941	-7,691	-1,441	4,809	11,059	17,309	23,559	

Tank Volume (Litre)	100	Time in Minutes for the Tank's temperature to drop by 21°F (11.67°C)								
DHW Flow (GPM)	2.5	Entering Domestic Cold Water °C / °F								
DHW Tank Temp. (°F)	131	1.67	4.45	7.23	10	12.78	15.56	18.34	21.12	
DHW Temp. Min (°F)	110	35	40	45	50	55	60	65	70	
Outdoor Dry Bulb Temperature °C / °F	-25	-13	4.11	4.54	5.06	5.73	6.59	7.77	9.46	12.08
	-20	-4	4.59	5.13	5.81	6.71	7.93	9.69	12.47	17.47
	-15	5	4.91	5.53	6.34	7.41	8.93	11.24	15.14	23.22
	-7	19.4	5.58	6.40	7.50	9.06	11.44	15.52	24.12	54.07
	2	35.6	5.97	6.92	8.23	10.15	13.23	19.00	33.69	149.07
	7	44.6	7.42	8.94	11.24	15.16	23.25	49.88		
	12	53.6	7.89	9.64	12.38	17.29	28.68	84.04		
	20	68	9.58	12.28	17.10	28.15	79.69			
	23	73.4	10.15	13.24	19.02	33.76	150.30			
	26	78.8	11.14	14.97	22.82	47.97				
	29	84.2	12.83	18.18	31.22	110.36				
	32	89.6	11.19	15.06	23.02	48.85				
35	95	13.48	19.52	35.38	188.79					

Annex "D" - ATW Heat Pumps Performance in DWH Mode

Tank Volume (Litre)	100	Volume of DHW in Litre extracted from the tank until it reaches the tank Min Temp.								
DHW Flow (GPM)	2.5	Entering Domestic Cold Water °C / °F								
DHW Tank Temp. (°F)	131	1.67	4.45	7.23	10	12.78	15.56	18.34	21.12	
DHW Temp. Min (°F)	110	35	40	45	50	55	60	65	70	
Outdoor Dry Bulb Temperature °C / °F	-25	-13	38.84	42.90	47.82	54.15	62.28	73.43	89.40	114.16
	-20	-4	43.38	48.48	54.90	63.41	74.94	91.57	117.84	165.09
	-15	5	46.40	52.26	59.91	70.02	84.39	106.22	143.07	219.43
	-7	19.4	52.73	60.48	70.88	85.62	108.11	146.66	227.93	510.96
	2	35.6	56.42	65.39	77.77	95.92	125.02	179.55	318.37	1,408.71
	7	44.6	70.12	84.48	106.22	143.26	219.71	471.37		
	12	53.6	74.56	91.10	116.99	163.39	271.03	794.18		
	20	68	90.53	116.05	161.60	266.02	753.07			
	23	73.4	95.92	125.12	179.74	319.03	1,420.34			
	26	78.8	105.27	141.47	215.65	453.32				
	29	84.2	121.24	171.80	295.03	1,042.90				
	32	89.6	105.75	142.32	217.54	461.63				
35	95	127.39	184.46	334.34	1,784.07					

Tank Volume (Litre)	100	Tank's Temperature Recovery Time in Minutes from various Entering Domestic Cold Water Temperatures to Maximum Temperature Set Point (131°F)								
DHW Flow (GPM)	2.5	Entering Domestic Cold Water °C / °F								
DHW Tank Temp. (°F)	131	1.67	4.45	7.23	10	12.78	15.56	18.34	21.12	
DHW Temp. Min (°F)	110	35	40	45	50	55	60	65	70	
Outdoor Dry Bulb Temperature °C / °F	-25	-13	45.28	42.93	40.57	38.21	35.85	33.49	31.13	28.78
	-20	-4	36.13	34.25	32.37	30.48	28.60	26.72	24.84	22.96
	-15	5	32.49	30.80	29.11	27.41	25.72	24.03	22.34	20.65
	-7	19.4	27.66	26.22	24.78	23.34	21.90	20.46	19.02	17.58
	2	35.6	25.82	24.47	23.13	21.79	20.44	19.10	17.75	16.41
	7	44.6	21.80	20.67	19.53	18.40	17.26	16.13	14.99	13.86
	12	53.6	20.99	19.90	18.80	17.71	16.62	15.52	14.43	13.34
	20	68	19.04	18.05	17.06	16.06	15.07	14.08	13.09	12.10
	23	73.4	18.58	17.62	16.65	15.68	14.71	13.74	12.78	11.81
	26	78.8	17.94	17.01	16.07	15.14	14.21	13.27	12.34	11.40
	29	84.2	17.15	16.26	15.36	14.47	13.58	12.68	11.79	10.90
	32	89.6	17.92	16.98	16.05	15.12	14.18	13.25	12.32	11.39
35	95	16.91	16.03	15.15	14.27	13.39	12.51	11.63	10.75	



Annex "D" - ATW Heat Pumps Performance in DWH Mode

HSS060V2LS with 200L Tank

Tank Volume (Litre)	200	Difference between energy supplied by heat pump at various outdoor air temperatures and energy required to heat DCW (from various Entering Domestic Cold Water Temperatures up to DHW Minimum Temperature)								
DHW Flow (GPM)	2.5	Entering Domestic Cold Water °C / °F								
DHW Tank Temp. (°F)	131	1.67	4.45	7.23	10	12.78	15.56	18.34	21.12	
DHW Temp. Min (°F)	110	35	40	45	50	55	60	65	70	
Outdoor Dry Bulb Temperature °C / °F	-25	-13	-66,285	-60,035	-53,785	-47,535	-41,285	-35,035	-28,785	-22,535
	-20	-4	-59,324	-53,074	-46,824	-40,574	-34,324	-28,074	-21,824	-15,574
	-15	5	-55,469	-49,219	-42,969	-36,719	-30,469	-24,219	-17,969	-11,719
	-7	19.4	-48,782	-42,532	-36,282	-30,032	-23,782	-17,532	-11,282	-5,032
	2	35.6	-45,575	-39,325	-33,075	-26,825	-20,575	-14,325	-8,075	-1,825
	7	44.6	-36,704	-30,454	-24,204	-17,954	-11,704	-5,454	796	7,046
	12	53.6	-34,487	-28,237	-21,987	-15,737	-9,487	-3,237	3,013	9,263
	20	68	-28,414	-22,164	-15,914	-9,664	-3,414	2,836	9,086	15,336
	23	73.4	-26,810	-20,560	-14,310	-8,060	-1,810	4,440	10,690	16,940
	26	78.8	-24,422	-18,172	-11,922	-5,672	578	6,828	13,078	19,328
	29	84.2	-21,215	-14,965	-8,715	-2,465	3,785	10,035	16,285	22,535
	32	89.6	-24,319	-18,069	-11,819	-5,569	681	6,931	13,181	19,431
35	95	-20,191	-13,941	-7,691	-1,441	4,809	11,059	17,309	23,559	

Tank Volume (Litre)	200	Time in Minutes for the Tank's temperature to drop by 21°F (11.67°C)								
DHW Flow (GPM)	2.5	Entering Domestic Cold Water °C / °F								
DHW Tank Temp. (°F)	131	1.67	4.45	7.23	10	12.78	15.56	18.34	21.12	
DHW Temp. Min (°F)	110	35	40	45	50	55	60	65	70	
Outdoor Dry Bulb Temperature °C / °F	-25	-13	8.21	9.07	10.12	11.45	13.18	15.53	18.91	24.15
	-20	-4	9.18	10.26	11.62	13.41	15.86	19.38	24.93	34.94
	-15	5	9.81	11.06	12.67	14.82	17.86	22.47	30.28	46.43
	-7	19.4	11.16	12.80	15.00	18.12	22.88	31.04	48.23	108.13
	2	35.6	11.94	13.84	16.45	20.29	26.45	37.99	67.38	298.13
	7	44.6	14.83	17.87	22.48	30.31	46.49	99.76		
	12	53.6	15.78	19.27	24.75	34.58	57.35	168.08		
	20	68	19.15	24.55	34.19	56.30	159.37			
	23	73.4	20.30	26.47	38.03	67.51	300.60			
	26	78.8	22.28	29.94	45.64	95.93				
	29	84.2	25.65	36.36	62.43	220.72				
	32	89.6	22.38	30.12	46.04	97.70				
35	95	26.95	39.03	70.75	377.57					

Annex "D" - ATW Heat Pumps Performance in DWH Mode

Tank Volume (Litre)	200	Volume of DHW in Litre extracted from the tank until it reaches the tank Min Temp.								
DHW Flow (GPM)	2.5	Entering Domestic Cold Water °C / °F								
DHW Tank Temp. (°F)	131	1.67	4.45	7.23	10	12.78	15.56	18.34	21.12	
DHW Temp. Min (°F)	110	35	40	45	50	55	60	65	70	
Outdoor Dry Bulb Temperature °C / °F	-25	-13	77.58	85.71	95.63	108.20	124.55	146.76	178.70	228.22
	-20	-4	86.75	96.96	109.81	126.72	149.88	183.14	235.59	330.18
	-15	5	92.70	104.52	119.73	140.05	168.78	212.34	286.15	438.76
	-7	19.4	105.46	120.96	141.75	171.23	216.22	293.33	455.77	1,021.83
	2	35.6	112.83	130.79	155.45	191.74	249.95	359.01	636.74	2,817.33
	7	44.6	140.14	168.87	212.44	286.43	439.33	942.73		
	12	53.6	149.12	182.10	233.89	326.78	541.96	1,588.36		
	20	68	180.97	232.00	323.10	532.04	1,506.05			
	23	73.4	191.84	250.14	359.38	637.97	2,840.67			
	26	78.8	210.55	282.93	431.30	906.54				
	29	84.2	242.39	343.60	589.96	2,085.80				
	32	89.6	211.49	284.63	435.08	923.27				
35	95	254.68	368.83	668.59	3,568.04					

Tank Volume (Litre)	200	Tank's Temperature Recovery Time in Minutes from various Entering Domestic Cold Water Temperatures to Maximum Temperature Set Point (131°F)								
DHW Flow (GPM)	2.5	Entering Domestic Cold Water °C / °F								
DHW Tank Temp. (°F)	131	1.67	4.45	7.23	10	12.78	15.56	18.34	21.12	
DHW Temp. Min (°F)	110	35	40	45	50	55	60	65	70	
Outdoor Dry Bulb Temperature °C / °F	-25	-13	90.56	85.85	81.13	76.41	71.70	66.98	62.26	57.55
	-20	-4	72.25	68.49	64.73	60.96	57.20	53.44	49.67	45.91
	-15	5	64.98	61.59	58.21	54.82	51.44	48.06	44.67	41.29
	-7	19.4	55.31	52.43	49.55	46.67	43.79	40.91	38.03	35.15
	2	35.6	51.63	48.94	46.26	43.57	40.88	38.19	35.50	32.81
	7	44.6	43.60	41.33	39.06	36.79	34.52	32.25	29.98	27.71
	12	53.6	41.97	39.79	37.60	35.42	33.23	31.04	28.86	26.67
	20	68	38.07	36.09	34.11	32.12	30.14	28.16	26.18	24.19
	23	73.4	37.16	35.23	33.29	31.35	29.42	27.48	25.55	23.61
	26	78.8	35.88	34.01	32.14	30.27	28.41	26.54	24.67	22.80
	29	84.2	34.29	32.51	30.72	28.94	27.15	25.36	23.58	21.79
	32	89.6	35.83	33.96	32.10	30.23	28.36	26.50	24.63	22.77
35	95	33.82	32.06	30.29	28.53	26.77	25.01	23.25	21.49	



Annex "D" - ATW Heat Pumps Performance in DWH Mode

HSS060V2LS with 300L Tank

Tank Volume (Litre)	300	Difference between energy supplied by heat pump at various outdoor air temperatures and energy required to heat DCW (from various Entering Domestic Cold Water Temperatures up to DHW Minimum Temperature)								
DHW Flow (GPM)	2.5	Entering Domestic Cold Water °C / °F								
DHW Tank Temp. (°F)	131	1.67	4.45	7.23	10	12.78	15.56	18.34	21.12	
DHW Temp. Min (°F)	110	35	40	45	50	55	60	65	70	
Outdoor Dry Bulb Temperature °C / °F	-25	-13	-66,285	-60,035	-53,785	-47,535	-41,285	-35,035	-28,785	-22,535
	-20	-4	-59,324	-53,074	-46,824	-40,574	-34,324	-28,074	-21,824	-15,574
	-15	5	-55,469	-49,219	-42,969	-36,719	-30,469	-24,219	-17,969	-11,719
	-7	19.4	-48,782	-42,532	-36,282	-30,032	-23,782	-17,532	-11,282	-5,032
	2	35.6	-45,575	-39,325	-33,075	-26,825	-20,575	-14,325	-8,075	-1,825
	7	44.6	-36,704	-30,454	-24,204	-17,954	-11,704	-5,454	796	7,046
	12	53.6	-34,487	-28,237	-21,987	-15,737	-9,487	-3,237	3,013	9,263
	20	68	-28,414	-22,164	-15,914	-9,664	-3,414	2,836	9,086	15,336
	23	73.4	-26,810	-20,560	-14,310	-8,060	-1,810	4,440	10,690	16,940
	26	78.8	-24,422	-18,172	-11,922	-5,672	578	6,828	13,078	19,328
	29	84.2	-21,215	-14,965	-8,715	-2,465	3,785	10,035	16,285	22,535
	32	89.6	-24,319	-18,069	-11,819	-5,569	681	6,931	13,181	19,431
35	95	-20,191	-13,941	-7,691	-1,441	4,809	11,059	17,309	23,559	

Tank Volume (Litre)	300	Time in Minutes for the Tank's temperature to drop by 21°F (11.67°C)								
DHW Flow (GPM)	2.5	Entering Domestic Cold Water °C / °F								
DHW Tank Temp. (°F)	131	1.67	4.45	7.23	10	12.78	15.56	18.34	21.12	
DHW Temp. Min (°F)	110	35	40	45	50	55	60	65	70	
Outdoor Dry Bulb Temperature °C / °F	-25	-13	12.32	13.60	15.18	17.17	19.77	23.30	28.36	36.22
	-20	-4	13.76	15.38	17.43	20.12	23.78	29.07	37.40	52.41
	-15	5	14.72	16.59	19.00	22.23	26.79	33.70	45.42	69.64
	-7	19.4	16.73	19.19	22.50	27.18	34.32	46.55	72.34	162.19
	2	35.6	17.91	20.76	24.68	30.43	39.67	56.98	101.07	447.19
	7	44.6	22.24	26.80	33.72	45.46	69.73	149.64		
	12	53.6	23.67	28.91	37.12	51.86	86.03	252.12		
	20	68	28.73	36.83	51.29	84.45	239.05			
	23	73.4	30.45	39.70	57.04	101.26	450.89			
	26	78.8	33.42	44.91	68.46	143.89				
	29	84.2	38.47	54.54	93.65	331.08				
	32	89.6	33.56	45.17	69.06	146.55				
35	95	40.42	58.54	106.12	566.35					



Annex "D" - ATW Heat Pumps Performance in DWH Mode

Tank Volume (Litre)	300	Volume of DHW in Litre extracted from the tank until it reaches the tank Min Temp.								
DHW Flow (GPM)	2.5	Entering Domestic Cold Water °C / °F								
DHW Tank Temp. (°F)	131	1.67	4.45	7.23	10	12.78	15.56	18.34	21.12	
DHW Temp. Min (°F)	110	35	40	45	50	55	60	65	70	
Outdoor Dry Bulb Temperature °C / °F	-25	-13	116.42	128.52	143.45	162.26	186.83	220.19	268.00	342.28
	-20	-4	130.03	145.34	164.71	190.13	224.72	274.71	353.43	495.27
	-15	5	139.10	156.78	179.55	210.07	253.17	318.47	429.22	658.10
	-7	19.4	158.10	181.35	212.63	256.85	324.32	439.90	683.61	1,532.70
	2	35.6	169.25	196.18	233.23	287.56	374.88	538.46	955.11	4,225.95
	7	44.6	210.17	253.26	318.65	429.60	658.95	1,414.10		
	12	53.6	223.68	273.20	350.78	490.08	812.98	2,382.53		
	20	68	271.50	348.04	484.69	798.05	2,259.02			
	23	73.4	287.75	375.17	539.03	956.91	4,260.91			
	26	78.8	315.82	424.40	646.95	1,359.76				
	29	84.2	363.54	515.40	884.99	3,128.71				
	32	89.6	317.14	426.86	652.62	1,384.90				
35	95	381.97	553.20	1,002.83	5,352.01					

Tank Volume (Litre)	300	Tank's Temperature Recovery Time in Minutes from various Entering Domestic Cold Water Temperatures to Maximum Temperature Set Point (131°F)								
DHW Flow (GPM)	2.5	Entering Domestic Cold Water °C / °F								
DHW Tank Temp. (°F)	131	1.67	4.45	7.23	10	12.78	15.56	18.34	21.12	
DHW Temp. Min (°F)	110	35	40	45	50	55	60	65	70	
Outdoor Dry Bulb Temperature °C / °F	-25	-13	135.84	128.77	121.69	114.62	107.54	100.47	93.39	86.32
	-20	-4	108.38	102.73	97.09	91.44	85.80	80.15	74.51	68.87
	-15	5	97.46	92.39	87.31	82.23	77.16	72.08	67.01	61.93
	-7	19.4	82.97	78.65	74.33	70.01	65.69	61.36	57.04	52.72
	2	35.6	77.45	73.41	69.38	65.35	61.31	57.28	53.25	49.21
	7	44.6	65.40	62.00	58.59	55.19	51.78	48.37	44.97	41.56
	12	53.6	62.96	59.68	56.40	53.12	49.84	46.56	43.28	40.01
	20	68	57.11	54.13	51.16	48.18	45.21	42.24	39.26	36.29
	23	73.4	55.74	52.84	49.93	47.03	44.13	41.22	38.32	35.42
	26	78.8	53.82	51.02	48.21	45.41	42.61	39.80	37.00	34.20
	29	84.2	51.44	48.76	46.08	43.40	40.72	38.04	35.37	32.69
	32	89.6	53.74	50.94	48.14	45.34	42.54	39.75	36.95	34.15
35	95	50.72	48.08	45.44	42.80	40.16	37.52	34.87	32.23	



Annex "D" - ATW Heat Pumps Performance in DWH Mode

HSS060V2LS with 400L Tank

Tank Volume (Litre)	400	Difference between energy supplied by heat pump at various outdoor air temperatures and energy required to heat DCW (from various Entering Domestic Cold Water Temperatures up to DHW Minimum Temperature)								
DHW Flow (GPM)	2.5	Entering Domestic Cold Water °C / °F								
DHW Tank Temp. (°F)	131	1.67	4.45	7.23	10	12.78	15.56	18.34	21.12	
DHW Temp. Min (°F)	110	35	40	45	50	55	60	65	70	
Outdoor Dry Bulb Temperature °C / °F	-25	-13	-66,285	-60,035	-53,785	-47,535	-41,285	-35,035	-28,785	-22,535
	-20	-4	-59,324	-53,074	-46,824	-40,574	-34,324	-28,074	-21,824	-15,574
	-15	5	-55,469	-49,219	-42,969	-36,719	-30,469	-24,219	-17,969	-11,719
	-7	19.4	-48,782	-42,532	-36,282	-30,032	-23,782	-17,532	-11,282	-5,032
	2	35.6	-45,575	-39,325	-33,075	-26,825	-20,575	-14,325	-8,075	-1,825
	7	44.6	-36,704	-30,454	-24,204	-17,954	-11,704	-5,454	796	7,046
	12	53.6	-34,487	-28,237	-21,987	-15,737	-9,487	-3,237	3,013	9,263
	20	68	-28,414	-22,164	-15,914	-9,664	-3,414	2,836	9,086	15,336
	23	73.4	-26,810	-20,560	-14,310	-8,060	-1,810	4,440	10,690	16,940
	26	78.8	-24,422	-18,172	-11,922	-5,672	578	6,828	13,078	19,328
	29	84.2	-21,215	-14,965	-8,715	-2,465	3,785	10,035	16,285	22,535
	32	89.6	-24,319	-18,069	-11,819	-5,569	681	6,931	13,181	19,431
35	95	-20,191	-13,941	-7,691	-1,441	4,809	11,059	17,309	23,559	

Tank Volume (Litre)	400	Time in Minutes for the Tank's temperature to drop by 21°F (11.67°C)								
DHW Flow (GPM)	2.5	Entering Domestic Cold Water °C / °F								
DHW Tank Temp. (°F)	131	1.67	4.45	7.23	10	12.78	15.56	18.34	21.12	
DHW Temp. Min (°F)	110	35	40	45	50	55	60	65	70	
Outdoor Dry Bulb Temperature °C / °F	-25	-13	16.42	18.13	20.24	22.90	26.36	31.06	37.81	48.29
	-20	-4	18.35	20.51	23.24	26.82	31.71	38.76	49.86	69.87
	-15	5	19.62	22.11	25.33	29.64	35.72	44.93	60.56	92.86
	-7	19.4	22.31	25.59	30.00	36.24	45.76	62.07	96.45	216.25
	2	35.6	23.88	27.68	32.90	40.57	52.89	75.97	134.76	596.25
	7	44.6	29.65	35.74	44.96	60.61	92.98	199.52		
	12	53.6	31.56	38.54	49.50	69.15	114.70	336.16		
	20	68	38.30	49.10	68.38	112.60	318.73			
	23	73.4	40.59	52.93	76.05	135.01	601.19			
	26	78.8	44.56	59.88	91.28	191.85				
	29	84.2	51.30	72.72	124.86	441.44				
	32	89.6	44.75	60.23	92.07	195.40				
35	95	53.90	78.06	141.49	755.13					

Annex "D" - ATW Heat Pumps Performance in DWH Mode

Tank Volume (Litre)	400	Volume of DHW in Litre extracted from the tank until it reaches the tank Min Temp.								
DHW Flow (GPM)	2.5	Entering Domestic Cold Water °C / °F								
DHW Tank Temp. (°F)	131	1.67	4.45	7.23	10	12.78	15.56	18.34	21.12	
DHW Temp. Min (°F)	110	35	40	45	50	55	60	65	70	
Outdoor Dry Bulb Temperature °C / °F	-25	-13	155.17	171.33	191.27	216.41	249.10	293.52	357.30	456.34
	-20	-4	173.41	193.82	219.62	253.45	299.66	366.28	471.18	660.27
	-15	5	185.41	208.94	239.37	280.10	337.55	424.59	572.29	877.53
	-7	19.4	210.83	241.83	283.50	342.47	432.43	586.56	911.45	2,043.56
	2	35.6	225.67	261.58	310.91	383.39	499.81	717.92	1,273.48	5,634.56
	7	44.6	280.19	337.74	424.87	572.76	878.66	1,885.46		
	12	53.6	298.24	364.20	467.78	653.47	1,083.92	3,176.71		
	20	68	361.94	464.00	646.19	1,064.07	3,012.00			
	23	73.4	383.58	500.19	718.67	1,275.84	5,681.25			
	26	78.8	421.09	565.87	862.60	1,812.98				
	29	84.2	484.79	687.20	1,179.93	4,171.61				
	32	89.6	422.89	569.17	870.06	1,846.53				
35	95	509.36	737.67	1,337.08	7,135.98					

Tank Volume (Litre)	400	Tank's Temperature Recovery Time in Minutes from various Entering Domestic Cold Water Temperatures to Maximum Temperature Set Point (131°F)								
DHW Flow (GPM)	2.5	Entering Domestic Cold Water °C / °F								
DHW Tank Temp. (°F)	131	1.67	4.45	7.23	10	12.78	15.56	18.34	21.12	
DHW Temp. Min (°F)	110	35	40	45	50	55	60	65	70	
Outdoor Dry Bulb Temperature °C / °F	-25	-13	181.12	171.69	162.25	152.82	143.39	133.96	124.52	115.09
	-20	-4	144.50	136.97	129.45	121.92	114.40	106.87	99.34	91.82
	-15	5	129.95	123.18	116.41	109.64	102.88	96.11	89.34	82.57
	-7	19.4	110.62	104.86	99.10	93.34	87.58	81.82	76.06	70.29
	2	35.6	103.26	97.88	92.51	87.13	81.75	76.37	70.99	65.62
	7	44.6	87.20	82.66	78.12	73.58	69.04	64.50	59.95	55.41
	12	53.6	83.94	79.57	75.20	70.83	66.46	62.08	57.71	53.34
	20	68	76.14	72.17	68.21	64.24	60.28	56.31	52.35	48.38
	23	73.4	74.32	70.45	66.57	62.70	58.83	54.96	51.09	47.22
	26	78.8	71.76	68.02	64.28	60.54	56.81	53.07	49.33	45.60
	29	84.2	68.58	65.01	61.44	57.87	54.30	50.72	47.15	43.58
	32	89.6	71.65	67.92	64.19	60.46	56.72	52.99	49.26	45.53
35	95	67.63	64.11	60.58	57.06	53.54	50.02	46.50	42.97	



Annex "D" - ATW Heat Pumps Performance in DWH Mode

HSS060V2LS with 500L Tank

Tank Volume (Litre)	500	Difference between energy supplied by heat pump at various outdoor air temperatures and energy required to heat DCW (from various Entering Domestic Cold Water Temperatures up to DHW Minimum Temperature)								
DHW Flow (GPM)	2.5	Entering Domestic Cold Water °C / °F								
DHW Tank Temp. (°F)	131	1.67	4.45	7.23	10	12.78	15.56	18.34	21.12	
DHW Temp. Min (°F)	110	35	40	45	50	55	60	65	70	
Outdoor Dry Bulb Temperature °C / °F	-25	-13	-66,285	-60,035	-53,785	-47,535	-41,285	-35,035	-28,785	-22,535
	-20	-4	-59,324	-53,074	-46,824	-40,574	-34,324	-28,074	-21,824	-15,574
	-15	5	-55,469	-49,219	-42,969	-36,719	-30,469	-24,219	-17,969	-11,719
	-7	19.4	-48,782	-42,532	-36,282	-30,032	-23,782	-17,532	-11,282	-5,032
	2	35.6	-45,575	-39,325	-33,075	-26,825	-20,575	-14,325	-8,075	-1,825
	7	44.6	-36,704	-30,454	-24,204	-17,954	-11,704	-5,454	796	7,046
	12	53.6	-34,487	-28,237	-21,987	-15,737	-9,487	-3,237	3,013	9,263
	20	68	-28,414	-22,164	-15,914	-9,664	-3,414	2,836	9,086	15,336
	23	73.4	-26,810	-20,560	-14,310	-8,060	-1,810	4,440	10,690	16,940
	26	78.8	-24,422	-18,172	-11,922	-5,672	578	6,828	13,078	19,328
	29	84.2	-21,215	-14,965	-8,715	-2,465	3,785	10,035	16,285	22,535
	32	89.6	-24,319	-18,069	-11,819	-5,569	681	6,931	13,181	19,431
35	95	-20,191	-13,941	-7,691	-1,441	4,809	11,059	17,309	23,559	

Tank Volume (Litre)	500	Time in Minutes for the Tank's temperature to drop by 21°F (11.67°C)								
DHW Flow (GPM)	2.5	Entering Domestic Cold Water °C / °F								
DHW Tank Temp. (°F)	131	1.67	4.45	7.23	10	12.78	15.56	18.34	21.12	
DHW Temp. Min (°F)	110	35	40	45	50	55	60	65	70	
Outdoor Dry Bulb Temperature °C / °F	-25	-13	20.53	22.66	25.29	28.62	32.95	38.83	47.26	60.36
	-20	-4	22.93	25.63	29.05	33.53	39.63	48.45	62.33	87.34
	-15	5	24.53	27.64	31.66	37.05	44.65	56.17	75.70	116.07
	-7	19.4	27.89	31.99	37.49	45.30	57.20	77.59	120.57	270.31
	2	35.6	29.85	34.59	41.13	50.71	66.11	94.96	168.45	745.31
	7	44.6	37.06	44.67	56.20	75.76	116.22	249.40		
	12	53.6	39.45	48.17	61.87	86.44	143.38	420.20		
	20	68	47.87	61.37	85.48	140.75	398.42			
	23	73.4	50.74	66.16	95.06	168.76	751.48			
	26	78.8	55.70	74.85	114.09	239.81				
	29	84.2	64.12	90.90	156.08	551.80				
	32	89.6	55.94	75.28	115.09	244.25				
35	95	67.37	97.57	176.86	943.91					



Annex "D" - ATW Heat Pumps Performance in DWH Mode

Tank Volume (Litre)	500	Volume of DHW in Litre extracted from the tank until it reaches the tank Min Temp.								
DHW Flow (GPM)	2.5	Entering Domestic Cold Water °C / °F								
DHW Tank Temp. (°F)	131	1.67	4.45	7.23	10	12.78	15.56	18.34	21.12	
DHW Temp. Min (°F)	110	35	40	45	50	55	60	65	70	
Outdoor Dry Bulb Temperature °C / °F	-25	-13	194.01	214.14	238.99	270.46	311.38	366.94	446.61	570.40
	-20	-4	216.69	242.20	274.52	316.86	374.50	457.85	589.02	825.36
	-15	5	231.81	261.20	299.19	350.12	421.94	530.81	715.37	1,096.86
	-7	19.4	263.56	302.31	354.28	428.09	540.54	733.23	1,139.39	2,554.43
	2	35.6	282.08	326.88	388.68	479.21	624.74	897.37	1,591.85	7,043.18
	7	44.6	350.22	422.13	531.09	715.93	1,098.28	2,356.83		
	12	53.6	372.80	455.21	584.67	816.86	1,354.94	3,970.89		
	20	68	452.37	579.95	807.79	1,330.09	3,765.07			
	23	73.4	479.49	625.21	898.32	1,594.78	7,101.49			
	26	78.8	526.37	707.33	1,078.15	2,266.20				
	29	84.2	605.93	859.01	1,474.96	5,214.51				
	32	89.6	528.63	711.40	1,087.60	2,308.16				
35	95	636.65	922.04	1,671.33	8,919.95					

Tank Volume (Litre)	500	Tank's Temperature Recovery Time in Minutes from various Entering Domestic Cold Water Temperatures to Maximum Temperature Set Point (131°F)								
DHW Flow (GPM)	2.5	Entering Domestic Cold Water °C / °F								
DHW Tank Temp. (°F)	131	1.67	4.45	7.23	10	12.78	15.56	18.34	21.12	
DHW Temp. Min (°F)	110	35	40	45	50	55	60	65	70	
Outdoor Dry Bulb Temperature °C / °F	-25	-13	226.40	214.61	202.82	191.03	179.23	167.44	155.65	143.86
	-20	-4	180.62	171.22	161.81	152.40	142.99	133.59	124.18	114.77
	-15	5	162.43	153.97	145.51	137.05	128.59	120.13	111.67	103.21
	-7	19.4	138.28	131.08	123.88	116.67	109.47	102.27	95.07	87.87
	2	35.6	129.07	122.35	115.63	108.91	102.19	95.46	88.74	82.02
	7	44.6	109.00	103.33	97.65	91.97	86.30	80.62	74.94	69.26
	12	53.6	104.93	99.46	94.00	88.53	83.07	77.60	72.14	66.67
	20	68	95.17	90.22	85.26	80.30	75.35	70.39	65.43	60.48
	23	73.4	92.89	88.06	83.22	78.38	73.54	68.70	63.87	59.03
	26	78.8	89.69	85.02	80.35	75.68	71.01	66.34	61.67	56.99
	29	84.2	85.73	81.26	76.80	72.33	67.87	63.40	58.94	54.47
	32	89.6	89.56	84.90	80.23	75.57	70.90	66.24	61.57	56.91
35	95	84.53	80.13	75.73	71.33	66.92	62.52	58.12	53.72	



Annex "D" - ATW Heat Pumps Performance in DWH Mode

Tank Volume (Litre)	100	Volume of DHW in Litre extracted from the tank until it reaches the tank Min Temp.								
DHW Flow (GPM)	2.5	Entering Domestic Cold Water °C / °F								
DHW Tank Temp. (°F)	131	1.67	4.45	7.23	10	12.78	15.56	18.34	21.12	
DHW Temp. Min (°F)	110	35	40	45	50	55	60	65	70	
Outdoor Dry Bulb Temperature °C / °F	-25	-13	45.08	50.56	57.65	67.10	80.14	99.51	131.17	192.50
	-20	-4	53.30	61.24	72.01	87.22	110.66	151.39	239.46	573.14
	-15	5	61.05	71.73	86.85	110.00	150.16	236.34	555.38	
	-7	19.4	76.17	93.46	120.87	171.23	293.14	1,020.22		
	2	35.6	103.01	137.40	206.20	413.44				
	7	44.6	195.33	371.95	3,877.43					
	12	53.6	373.46	4,048.47						
	20	68	5,882.72							
	23	73.4								
	26	78.8								
	29	84.2								
	32	89.6								
35	95									

Tank Volume (Litre)	100	Tank's Temperature Recovery Time in Minutes from various Entering Domestic Cold Water Temperatures to Maximum Temperature Set Point (131°F)								
DHW Flow (GPM)	2.5	Entering Domestic Cold Water °C / °F								
DHW Tank Temp. (°F)	131	1.67	4.45	7.23	10	12.78	15.56	18.34	21.12	
DHW Temp. Min (°F)	110	35	40	45	50	55	60	65	70	
Outdoor Dry Bulb Temperature °C / °F	-25	-13	33.94	32.18	30.41	28.64	26.87	25.10	23.34	21.57
	-20	-4	27.33	25.91	24.48	23.06	21.64	20.21	18.79	17.37
	-15	5	24.10	22.84	21.59	20.33	19.08	17.82	16.57	15.31
	-7	19.4	20.74	19.66	18.58	17.50	16.42	15.34	14.26	13.18
	2	35.6	18.09	17.14	16.20	15.26	14.32	13.38	12.44	11.49
	7	44.6	15.44	14.63	13.83	13.03	12.22	11.42	10.61	9.81
	12	53.6	14.32	13.58	12.83	12.08	11.34	10.59	9.85	9.10
	20	68	13.33	12.64	11.94	11.25	10.56	9.86	9.17	8.47
	23	73.4	12.95	12.27	11.60	10.93	10.25	9.58	8.90	8.23
	26	78.8	12.73	12.06	11.40	10.74	10.08	9.41	8.75	8.09
	29	84.2	12.47	11.82	11.17	10.52	9.87	9.22	8.57	7.92
	32	89.6	12.68	12.02	11.36	10.70	10.04	9.38	8.72	8.06
35	95	12.92	12.24	11.57	10.90	10.23	9.55	8.88	8.21	



Annex "D" - ATW Heat Pumps Performance in DWH Mode

Tank Volume (Litre)	200	Volume of DHW in Litre extracted from the tank until it reaches the tank Min Temp.								
DHW Flow (GPM)	2.5	Entering Domestic Cold Water °C / °F								
DHW Tank Temp. (°F)	131	1.67	4.45	7.23	10	12.78	15.56	18.34	21.12	
DHW Temp. Min (°F)	110	35	40	45	50	55	60	65	70	
Outdoor Dry Bulb Temperature °C / °F	-25	-13	90.06	101.12	115.29	134.10	160.18	198.92	262.24	384.99
	-20	-4	106.60	122.47	143.92	174.45	221.32	302.78	478.93	1,146.19
	-15	5	122.09	143.36	173.60	220.00	300.23	472.69	1,110.75	
	-7	19.4	152.33	186.83	241.73	342.37	586.28	2,040.35		
	2	35.6	206.01	274.71	412.40	826.88				
	7	44.6	390.66	743.81	7,754.86					
	12	53.6	746.83	8,096.85						
	20	68	11,765.44							
	23	73.4								
	26	78.8								
	29	84.2								
	32	89.6								
35	95									

Tank Volume (Litre)	200	Tank's Temperature Recovery Time in Minutes from various Entering Domestic Cold Water Temperatures to Maximum Temperature Set Point (131°F)								
DHW Flow (GPM)	2.5	Entering Domestic Cold Water °C / °F								
DHW Tank Temp. (°F)	131	1.67	4.45	7.23	10	12.78	15.56	18.34	21.12	
DHW Temp. Min (°F)	110	35	40	45	50	55	60	65	70	
Outdoor Dry Bulb Temperature °C / °F	-25	-13	67.88	64.35	60.81	57.28	53.74	50.20	46.67	43.13
	-20	-4	54.65	51.81	48.96	46.11	43.27	40.42	37.57	34.73
	-15	5	48.19	45.68	43.17	40.66	38.15	35.64	33.13	30.62
	-7	19.4	41.47	39.31	37.15	34.99	32.83	30.67	28.51	26.35
	2	35.6	36.17	34.28	32.40	30.52	28.63	26.75	24.87	22.98
	7	44.6	30.87	29.26	27.65	26.05	24.44	22.83	21.22	19.62
	12	53.6	28.64	27.15	25.66	24.16	22.67	21.18	19.69	18.20
	20	68	26.66	25.27	23.88	22.49	21.11	19.72	18.33	16.94
	23	73.4	25.89	24.54	23.20	21.85	20.50	19.15	17.80	16.45
	26	78.8	25.45	24.12	22.80	21.47	20.15	18.82	17.50	16.17
	29	84.2	24.93	23.63	22.33	21.03	19.74	18.44	17.14	15.84
	32	89.6	25.36	24.04	22.72	21.40	20.08	18.76	17.44	16.12
35	95	25.83	24.48	23.14	21.79	20.45	19.10	17.76	16.41	



Annex "D" - ATW Heat Pumps Performance in DWH Mode

Tank Volume (Litre)	300	Volume of DHW in Litre extracted from the tank until it reaches the tank Min Temp.								
DHW Flow (GPM)	2.5	Entering Domestic Cold Water °C / °F								
DHW Tank Temp. (°F)	131	1.67	4.45	7.23	10	12.78	15.56	18.34	21.12	
DHW Temp. Min (°F)	110	35	40	45	50	55	60	65	70	
Outdoor Dry Bulb Temperature °C / °F	-25	-13	135.14	151.67	172.94	201.10	240.22	298.34	393.40	577.40
	-20	-4	159.89	183.71	215.84	261.58	331.98	454.07	718.39	1,719.24
	-15	5	183.14	214.99	260.35	329.90	450.29	708.94	1,666.13	
	-7	19.4	228.41	280.29	362.60	513.51	879.42	3,060.48		
	2	35.6	308.92	412.02	618.60	1,240.31				
	7	44.6	585.90	1,115.67	11,632.29					
	12	53.6	1,120.20	12,145.23						
	20	68	17,648.06							
	23	73.4								
	26	78.8								
	29	84.2								
	32	89.6								
35	95									

Tank Volume (Litre)	300	Tank's Temperature Recovery Time in Minutes from various Entering Domestic Cold Water Temperatures to Maximum Temperature Set Point (131°F)								
DHW Flow (GPM)	2.5	Entering Domestic Cold Water °C / °F								
DHW Tank Temp. (°F)	131	1.67	4.45	7.23	10	12.78	15.56	18.34	21.12	
DHW Temp. Min (°F)	110	35	40	45	50	55	60	65	70	
Outdoor Dry Bulb Temperature °C / °F	-25	-13	101.82	96.52	91.21	85.91	80.61	75.30	70.00	64.70
	-20	-4	81.97	77.71	73.44	69.17	64.90	60.63	56.36	52.09
	-15	5	72.28	68.51	64.75	60.98	57.22	53.46	49.69	45.93
	-7	19.4	62.21	58.97	55.73	52.49	49.25	46.01	42.77	39.53
	2	35.6	54.25	51.42	48.60	45.77	42.95	40.12	37.30	34.47
	7	44.6	46.30	43.89	41.48	39.07	36.66	34.24	31.83	29.42
	12	53.6	42.95	40.72	38.48	36.24	34.01	31.77	29.53	27.30
	20	68	39.99	37.90	35.82	33.74	31.66	29.57	27.49	25.41
	23	73.4	38.84	36.81	34.79	32.77	30.75	28.72	26.70	24.68
	26	78.8	38.17	36.18	34.20	32.21	30.22	28.23	26.24	24.26
	29	84.2	37.39	35.44	33.49	31.55	29.60	27.65	25.71	23.76
	32	89.6	38.04	36.06	34.08	32.10	30.12	28.13	26.15	24.17
35	95	38.74	36.72	34.70	32.69	30.67	28.65	26.64	24.62	



Annex "D" - ATW Heat Pumps Performance in DWH Mode

Tank Volume (Litre)	400	Volume of DHW in Litre extracted from the tank until it reaches the tank Min Temp.								
DHW Flow (GPM)	2.5	Entering Domestic Cold Water °C / °F								
DHW Tank Temp. (°F)	131	1.67	4.45	7.23	10	12.78	15.56	18.34	21.12	
DHW Temp. Min (°F)	110	35	40	45	50	55	60	65	70	
Outdoor Dry Bulb Temperature °C / °F	-25	-13	180.12	202.23	230.58	268.10	320.36	397.75	524.48	769.89
	-20	-4	213.19	244.94	287.75	348.80	442.54	605.46	957.85	2,292.29
	-15	5	244.09	286.62	347.10	439.90	600.36	945.28	2,221.41	
	-7	19.4	304.57	373.65	483.46	684.65	1,172.56	4,080.60		
	2	35.6	411.93	549.42	824.80	1,653.75				
	7	44.6	781.23	1,487.52	15,509.72					
	12	53.6	1,493.57	16,193.61						
	20	68	23,530.78							
	23	73.4								
	26	78.8								
	29	84.2								
	32	89.6								
35	95									

Tank Volume (Litre)	400	Tank's Temperature Recovery Time in Minutes from various Entering Domestic Cold Water Temperatures to Maximum Temperature Set Point (131°F)								
DHW Flow (GPM)	2.5	Entering Domestic Cold Water °C / °F								
DHW Tank Temp. (°F)	131	1.67	4.45	7.23	10	12.78	15.56	18.34	21.12	
DHW Temp. Min (°F)	110	35	40	45	50	55	60	65	70	
Outdoor Dry Bulb Temperature °C / °F	-25	-13	135.76	128.69	121.62	114.55	107.48	100.40	93.33	86.26
	-20	-4	109.30	103.61	97.91	92.22	86.53	80.84	75.14	69.45
	-15	5	96.37	91.35	86.33	81.31	76.29	71.27	66.25	61.24
	-7	19.4	82.94	78.62	74.30	69.98	65.66	61.34	57.02	52.70
	2	35.6	72.33	68.56	64.79	61.03	57.26	53.49	49.73	45.96
	7	44.6	61.73	58.52	55.30	52.09	48.87	45.66	42.44	39.23
	12	53.6	57.27	54.29	51.31	48.32	45.34	42.36	39.37	36.39
	20	68	53.31	50.54	47.76	44.98	42.21	39.43	36.65	33.88
	23	73.4	51.78	49.08	46.39	43.69	40.99	38.30	35.60	32.90
	26	78.8	50.89	48.24	45.59	42.94	40.29	37.64	34.99	32.34
	29	84.2	49.85	47.25	44.66	42.06	39.47	36.87	34.27	31.68
	32	89.6	50.72	48.08	45.43	42.79	40.15	37.51	34.87	32.23
35	95	51.65	48.96	46.27	43.58	40.89	38.20	35.51	32.82	



Annex "D" - ATW Heat Pumps Performance in DWH Mode

Tank Volume (Litre)	500	Volume of DHW in Litre extracted from the tank until it reaches the tank Min Temp.								
DHW Flow (GPM)	2.5	Entering Domestic Cold Water °C / °F								
DHW Tank Temp. (°F)	131	1.67	4.45	7.23	10	12.78	15.56	18.34	21.12	
DHW Temp. Min (°F)	110	35	40	45	50	55	60	65	70	
Outdoor Dry Bulb Temperature °C / °F	-25	-13	225.10	252.79	288.23	335.19	400.40	497.16	655.64	962.39
	-20	-4	266.49	306.18	359.76	435.93	553.20	756.76	1,197.32	2,865.33
	-15	5	305.14	358.34	433.85	549.80	750.42	1,181.53	2,776.79	
	-7	19.4	380.65	467.11	604.33	855.79	1,465.70	5,100.73		
	2	35.6	514.84	686.73	1,031.00	2,067.19				
	7	44.6	976.56	1,859.38	19,387.15					
	12	53.6	1,866.94	20,241.99						
	20	68	29,413.41							
	23	73.4								
	26	78.8								
	29	84.2								
	32	89.6								
35	95									

Tank Volume (Litre)	500	Tank's Temperature Recovery Time in Minutes from various Entering Domestic Cold Water Temperatures to Maximum Temperature Set Point (131°F)								
DHW Flow (GPM)	2.5	Entering Domestic Cold Water °C / °F								
DHW Tank Temp. (°F)	131	1.67	4.45	7.23	10	12.78	15.56	18.34	21.12	
DHW Temp. Min (°F)	110	35	40	45	50	55	60	65	70	
Outdoor Dry Bulb Temperature °C / °F	-25	-13	169.69	160.86	152.02	143.18	134.34	125.50	116.67	107.83
	-20	-4	136.62	129.51	122.39	115.27	108.16	101.04	93.93	86.81
	-15	5	120.46	114.19	107.91	101.64	95.36	89.09	82.82	76.54
	-7	19.4	103.67	98.27	92.87	87.47	82.07	76.68	71.28	65.88
	2	35.6	90.41	85.70	80.99	76.28	71.57	66.86	62.16	57.45
	7	44.6	77.16	73.14	69.13	65.11	61.09	57.07	53.05	49.03
	12	53.6	71.59	67.86	64.13	60.40	56.67	52.95	49.22	45.49
	20	68	66.64	63.17	59.70	56.23	52.76	49.29	45.82	42.35
	23	73.4	64.72	61.35	57.98	54.61	51.24	47.87	44.50	41.13
	26	78.8	63.62	60.30	56.99	53.68	50.36	47.05	43.74	40.42
	29	84.2	62.31	59.07	55.82	52.58	49.33	46.09	42.84	39.60
	32	89.6	63.40	60.09	56.79	53.49	50.19	46.89	43.59	40.28
35	95	64.56	61.20	57.84	54.48	51.11	47.75	44.39	41.03	

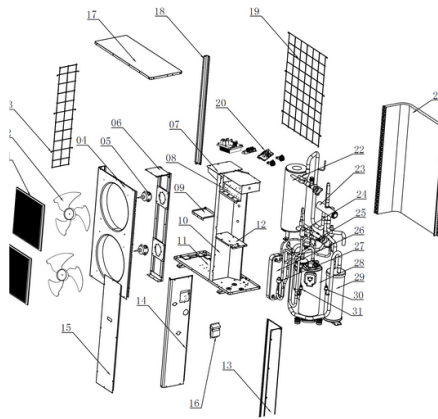
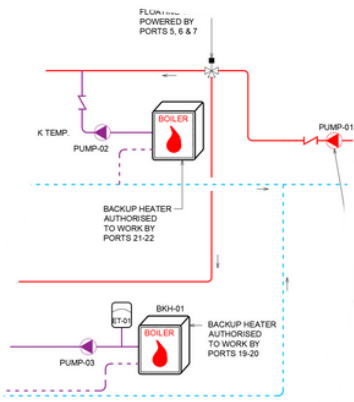

DEAD BAND
 SET POINT
 EX: 14°C (57.2°F)

DEAD BAND
 (ONLY DHW MODE
 ALLOWED)
 EX: 4°C (7.2°F)

12	13	14
Cooling linkage switch	COM	Heating linkage switch

15	16	17	18	1
COM	AC Linkage switch	INDOOR PUMP LINKAGE SIGNAL	OUTDOOR PUMP LINKAGE SIGNAL	

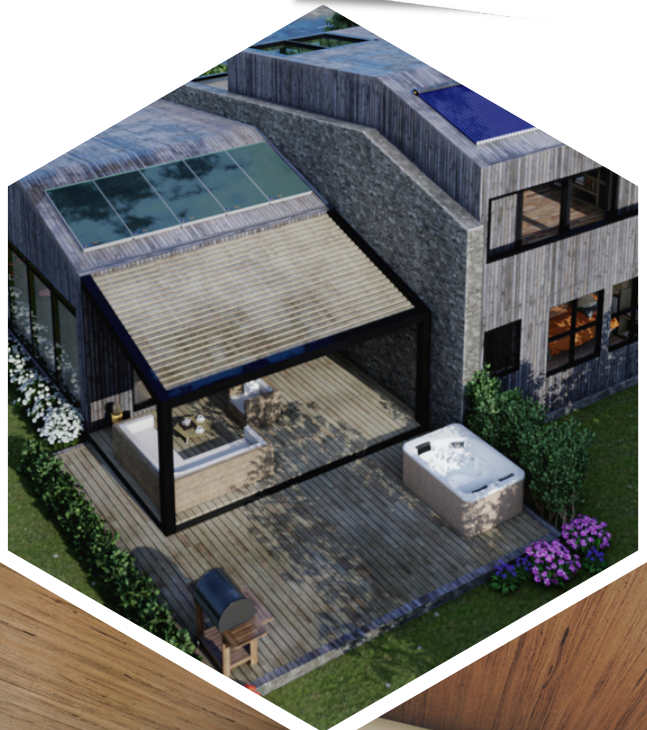

Aqua Solanor Inc. is the owner of **Hydro Solar Innovative Energy**
 2305 46th Avenue
 Lachine (QC), Canada H8T 3C9
 Email: design@hydrosolar.ca Web Site: www.hydrosolar.ca