

# DeltaSol<sup>®</sup> BS Plus

(Version 2)

# RESOL<sup>®</sup>

## Solar controller

Manual for the  
specialised craftsman

**Installation**  
**Operation**  
**Functions and options**  
**Troubleshooting**



c us

The cTUVus certification confirms that the controller is certified to UL 60730-1:2009 and CSA B60730.1:2002.



The Internet portal for easy and secure access to your system data – [www.vbus.net](http://www.vbus.net)

Thank you for buying this RESOL product.  
Please read this manual carefully to get the best performance from this unit.  
Please keep this manual safe.



48005931

en

Manual

[www.resol.com](http://www.resol.com)

## Safety advice

Please pay attention to the following safety advice in order to avoid danger and damage to people and property.

## Instructions

Attention must be paid to the valid local standards, regulations and directives!

## Information about the product

### Proper usage

The solar controller is designed for electronically controlling standard solar thermal systems in compliance with the technical data specified in this manual.

Improper use excludes all liability claims.

### CE Declaration of conformity

The product complies with the relevant directives and is therefore labelled with the CE mark. The Declaration of Conformity is available on request, please contact the manufacturer.



### Note

Strong electromagnetic fields can impair the function of the device.

→ Make sure the device as well as the system are not exposed to strong electromagnetic fields.

## Target group

These instructions are exclusively addressed to authorised skilled personnel.

Only qualified electricians are allowed to carry out electrical works.

Initial commissioning must be effected by the system installer or qualified personnel named by the system installer.

## Description of symbols

**WARNING!** Warnings are indicated with a warning triangle!



→ They contain information on how to avoid the danger described.

Signal words describe the danger that may occur, when it is not avoided.

- **WARNING** means that injury, possibly life-threatening injury, can occur.
- **ATTENTION** means that damage to the appliance can occur.



### Note

Notes are indicated with an information symbol.

→ Arrows indicate instruction steps that should be carried out.

## Disposal

- Dispose of the packaging in an environmentally sound manner.
- At the end of its working life, the product must not be disposed of as urban waste. Old appliances must be disposed of by an authorised body in an environmentally sound manner. Upon request we will take back your old appliances bought from us and guarantee an environmentally sound disposal of the devices.



**Subject to technical change. Errors excepted.**

The DeltaSol® BS Plus is our most versatile controller for simple standard solar thermal and heating systems. The intuitive commissioning menu leads you through the initial configuration in only 6 steps.

The system selected is shown on the display, the status of the individual components is indicated by means of flashing codes.

## Contents

<b>1 Overview</b> .....	<b>4</b>	<b>5 Commissioning</b> .....	<b>36</b>
<b>2 Installation</b> .....	<b>5</b>	<b>6 Channel overview</b> .....	<b>38</b>
2.1 Mounting .....	5	6.1 Display channels .....	38
2.2 Electrical connection .....	6	6.2 Adjustment channels .....	41
2.3 Data communication / Bus .....	6	<b>7 Troubleshooting</b> .....	<b>51</b>
2.4 System overview .....	7	<b>8 Accessories</b> .....	<b>54</b>
2.5 Systems .....	8	8.1 Sensors and measuring instruments .....	55
<b>3 Operation and function</b> .....	<b>34</b>	8.2 VBus® accessories .....	55
3.1 Buttons .....	34	8.3 Interface adapters .....	56
<b>4 System-Monitoring-Display</b> .....	<b>34</b>	8.4 Accessories .....	56
4.1 System screen .....	35	<b>9 Index</b> .....	<b>57</b>
4.2 Other indications .....	35		

# 1 Overview

- 10 basic systems to choose from
- Heat quantity measurement
- Function control
- Optional thermostat function (time-controlled), thermal disinfection function, drainback function
- Commissioning menu
- Unit °F and °C selectable
- HE pump control via adapter (see page 49)

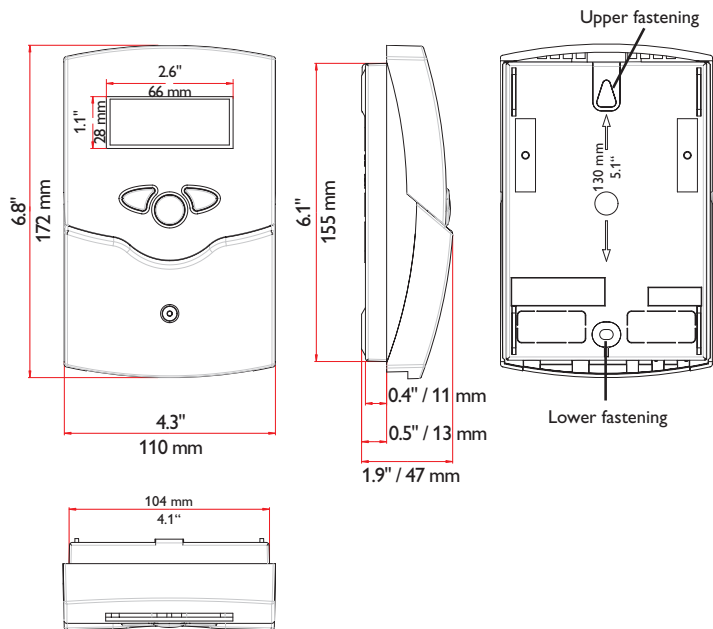

## Technical data

**Inputs:** 4 Pt1000 temperature sensors

**Outputs:** 2 semiconductor relays

**Switching capacity:** 1 (1) A 240 V~ (semiconductor relay)

**Total switching capacity:** 2 A 240 V~

**Power supply:** 100 ... 240 V~ (50 ... 60 Hz)

**Supply connection:** type Y attachment

**Standby:** 0.38 W

**Temperature controls class:** I

**Energy efficiency contribution:** 1 %

**Mode of operation:** type 1.C.Y action

**Rated impulse voltage:** 2.5 kV

**Data interface:** RESOL VBus®

**VBus® current supply:** 35 mA

**Functions:** function control, operating hours counter, tube collector function, thermostat function, speed control and heat quantity measurement

**Housing:** plastic, PC-ABS and PMMA

**Mounting:** wall mounting, also suitable for mounting into patch panels

**Indication/Display:** System-Monitoring-Display for visualisation of systems, 16-segment and 7-segment display, 8 symbols for indication of system status and operating control LED

**Operation:** 3 push buttons at the front of the housing

**Protection type:** IP 20 / DIN EN 60529

**Protection class:** II

**Ambient temperature:** 0 ... 40 °C [32 ... 104 °F]

**Degree of pollution:** 2

**Dimensions:** 172 x 110 x 49 mm

## 2 Installation

### 2.1 Mounting

#### **WARNING!** Electric shock!



Upon opening the housing, live parts are exposed!

→ **Always disconnect the device from power supply before opening the housing!**



#### **Note**

Strong electromagnetic fields can impair the function of the device.

→ Make sure the device as well as the system are not exposed to strong electromagnetic fields.

The device must only be located in dry interior rooms.

The controller must additionally be supplied from a double pole switch with contact gap of at least 3 mm.

Please pay attention to separate routing of sensor cables and mains cables.

In order to mount the device to the wall, carry out the following steps:

- Unscrew the crosshead screw from the cover and remove it along with the cover from the housing.
- Mark the upper fastening point on the wall. Drill and fasten the enclosed wall plug and screw leaving the head protruding.
- Hang the housing from the upper fastening point and mark the lower fastening point (centres 130 mm).
- Insert lower wall plug.
- Fasten the housing to the wall with the lower fastening screw and tighten.
- Carry out the electrical wiring in accordance with the terminal allocation (see page 6).
- Put the cover on the housing.
- Attach with the fastening screw.

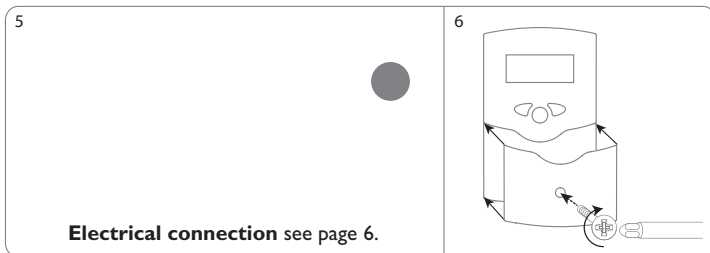
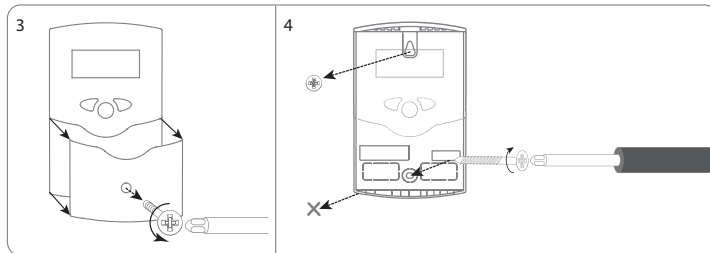
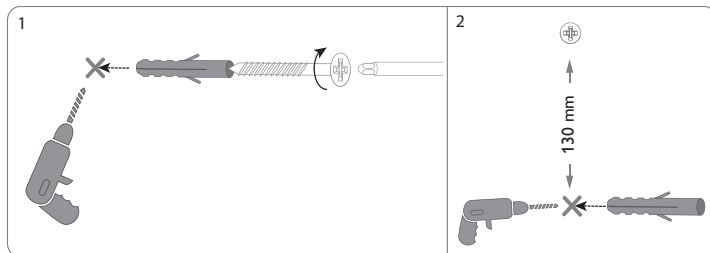

**Electrical connection** see page 6.

## 2.2 Electrical connection

### WARNING! Electric shock!



Upon opening the housing, live parts are exposed!

→ **Always disconnect the device from power supply before opening the housing!**

### ATTENTION! ESD damage!



Electrostatic discharge can lead to damage to electronic components!

→ **Take care to discharge properly before touching the inside of the device!**



#### Note

Connecting the device to the power supply must always be the last step of the installation!



#### Note

It must be possible to disconnect the device from the mains at any time.

→ Install the mains plug such that it is accessible at any time.

→ If this is not possible, install a switch that can be accessed.

### Do not use the device if it is visibly damaged!

The power supply of the device must be 100 ... 240V~ (50 ... 60Hz). Attach flexible cables to the housing with the enclosed strain relief and the corresponding screws.

The controller is equipped with 2 semiconductor relays to which loads such as pumps, valves, etc. can be connected:

- Relay 1, also designed for pump speed control
- Relay 2, also designed for pump speed control
- 18 = Conductor R1
- 16 = Conductor R2
- 17 = Neutral conductor N
- 15 = Neutral conductor N
- 13 = Grounding terminal ⚡
- 14 = Grounding terminal ⚡



#### Note

If loads which are not speed-controlled (e.g. valves) are used, the speed must be set to 100%.

Connect the **temperature sensors** (S1 to S4) to the following terminals with either polarity:

1/2 = Sensor 1 (e.g. collector sensor)

3/4 = Sensor 2 (e.g. store sensor)

5/6 = Sensor 3 (e.g. store sensor top)

7/8 = Sensor 4 (e.g. return sensor)

The **mains connection** is at the following terminals:

19 = Neutral conductor N

20 = Conductor L

12 = Grounding terminal ⚡

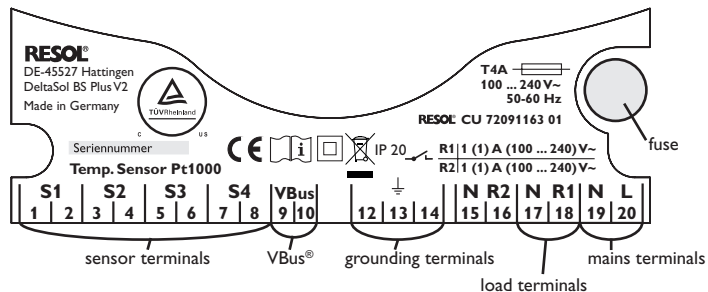

## 2.3 Data communication/Bus

The controller is equipped with the **RESOL VBus®** for data transfer and energy supply to external modules. The connection is to be carried out at the terminals marked **VBus** (any polarity).

One or more **RESOL VBus®** modules can be connected via this data bus, such as:

- RESOL DL2 Datalogger
- RESOL DL3 Datalogger
- VBus®/PWM interface adapter

Furthermore, the controller can be connected to a PC or integrated into a network via the RESOL VBus®/USB or VBus®/LAN interface adapter (not included). Different solutions for visualisation and remote parameterisation are available on the RESOL website [www.resol.com](http://www.resol.com).



#### Note

More accessories on page 54.

## 2.4 System overview

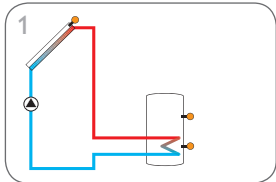

Standard solar system (page 8)

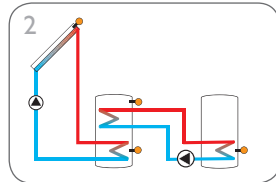

Solar system with heat exchange (page 10)

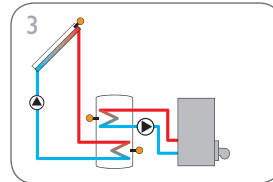

Solar system with afterheating (page 14)

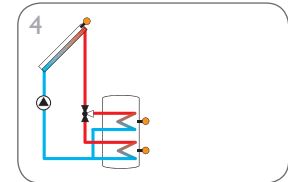

Solar system with store loading in layers (page 18)

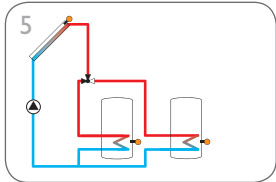

Solar system with 2 stores and valve logic (page 20)

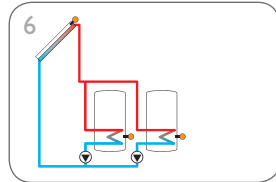

Solar system with 2 stores and pump logic (page 22)

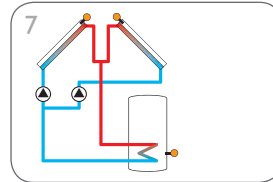

Solar system with east-/west collectors and 1 store (page 24)

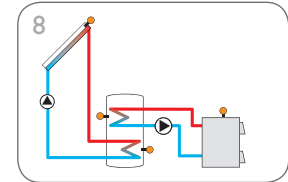

Solar system with afterheating by solid fuel boiler (page 26)

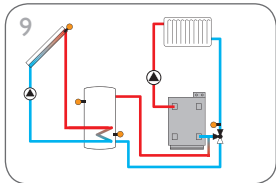

Solar system with heating circuit return preheating (page 30)

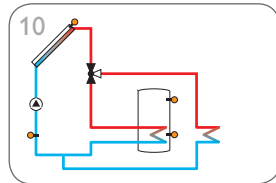

Standard solar system with heat dump (page 32)

## 2.5 Systems

### Arrangement 1: Standard solar system

The controller calculates the temperature difference between collector sensor S1 and store sensor S2. If the difference is larger than or identical to the adjusted switch-on temperature difference (DT O), the solar pump will be activated by relay 1, and the store will be loaded until the switch-off temperature difference (DT F) or the maximum store temperature (S MX) is reached.

Sensors S3 and S4 can optionally be connected for measurement purposes. S3 can optionally be used as the reference sensor for the store emergency shutdown option (OSEM).

If heat quantity measurement (OHQM) is activated, S4 is to be used as the return sensor.

If the drainback option (ODB) is activated, relay 2 can be used for activating a booster pump. For this purpose, the booster function (OBST) has to be activated.

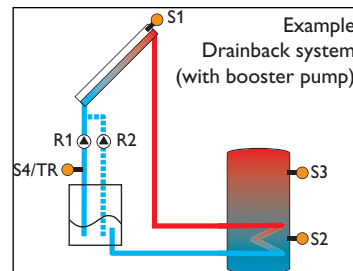
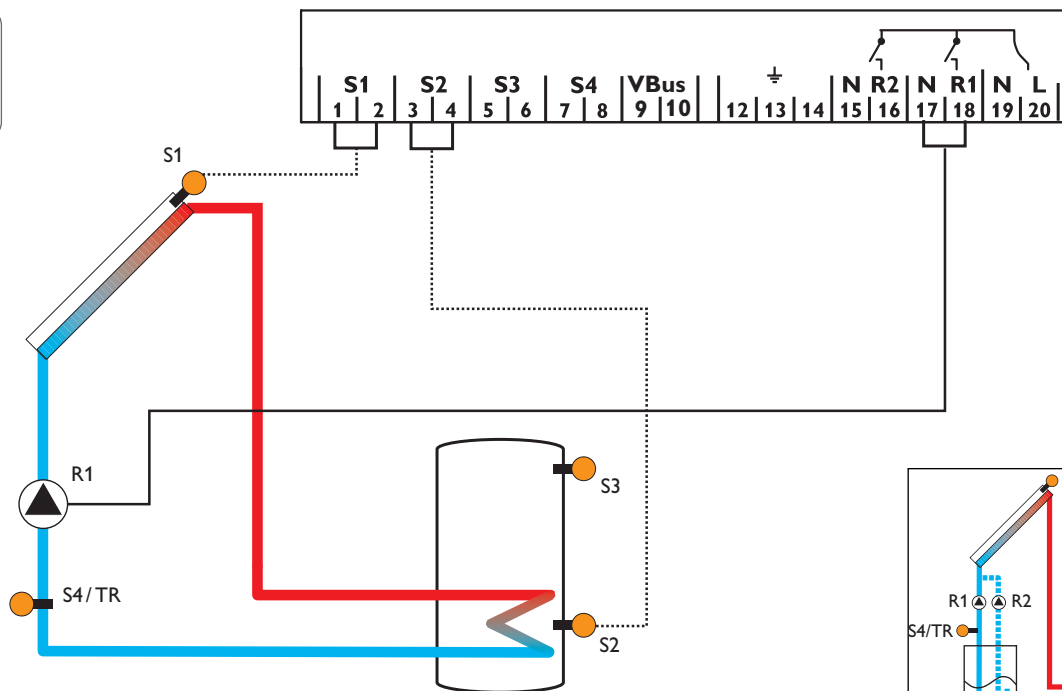
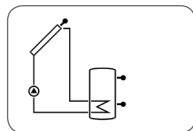



Display channels			
Channel	Description	Connection terminal	Page
INIT	x* ODB initialisation active	-	38
FLL	x* ODB filling time active	-	38
STAB	x* ODB stabilisation in progress	-	38
COL	x Temperature collector	S1	38
TST	x Temperature store	S2	38
S3	x Temperature sensor 3	S3	39
TSTT	x* Temperature store top	S3	38
S4	x Temperature sensor 4	S4	39
TR	x* Temperature return sensor	S4	38
n %	x Speed R1	R1	39
hP	x Operating hours R1	R1	40
hP1	x* Operating hours R1 (if OBST is activated)	R1	40
hP2	x* Operating hours R2 (if OBST is activated)	R2	40
kWh	x* Heat quantity in kWh	-	39
MWh	x* Heat quantity in MWh	-	39
TIME	x Time	-	40

Adjustment channels			
Channel	Description	Factory setting	Page
Arr	x System	1	41
DT O	x Switch-on temperature difference	6.0K [12.0 °Ra]	41
DT F	x Switch-off temperature difference	4.0K [8.0 °Ra]	41
DT S	x Set temperature difference	10.0K [20.0 °Ra]	42
RIS	x Rise R1	2K [4 °Ra]	42
nMN	x Minimum speed	30%	42
S MX	x Maximum store temperature	60 °C [140 °F]	42
OSEM	x Store emergency shutdown option	OFF	43
	Collector emergency temperature	130 °C [270 °F]	43
EM	x Collector emergency temperature, if OBST is activated:	95 °C [200 °F]	43
OCC	x Collector cooling option	OFF	43
CMX	x* Maximum collector temperature	110 °C [230 °F]	43
OSYC	x System cooling option	OFF	44
DTCO	x* Switch-on temperature difference cooling	20.0K [40.0 °Ra]	44
DTCF	x* Switch-off temperature difference cooling	15.0K [30.0 °Ra]	44
OSTC	x Store cooling option	OFF	44
OHOL	x* Holiday cooling option	OFF	44
THOL	x* Holiday cooling temperature	40 °C [110 °F]	44

Adjustment channels			
Channel	Description	Factory setting	Page
OCN	x Collector minimum limitation option	OFF	45
CMN	x* Collector minimum temperature	10 °C [50 °F]	45
OCF	x Antifreeze option	OFF	45
CFR	x* Antifreeze temperature	4.0 °C [40.0 °F]	45
OTC	x Tube collector option	OFF	47
TCST	x* OTC starting time	07:00	47
TCEN	x* OTC ending time	19:00	47
TCRU	x* OTC runtime	30 s	47
TCIN	x* OTC standstill interval	30 min	47
OHQM	x Heat quantity measurement option	OFF	47
FMAX	x* Maximum flow rate	6.0 l	47
MEDT	x* Heat transfer fluid/Antifreeze type	1	48
MED%	x* Antifreeze concentration (only if MEDT = propylene or ethylene)	45 %	48
ODB	x Drainback option	OFF	48
tDTO	x* ODB switch-on condition - time period	60 s	48
tFLL	x* ODB filling time	5.0 min	49
tSTB	x* ODB stabilisation time	2.0 min	49
OBST	s* Option booster function	OFF	49
MAN1	x Manual mode R1	Auto	49
MAN2	x Manual mode R2	Auto	49
ADA1	x HE pump control	OFF	49
LANG	x Language	dE	50
UNIT	x Temperature unit	°C	50
RESE	x Reset - back to factory settings		50
#####	Version number		

### Legend:

Symbol	Description
x	Channel is available
x*	Channel is available, if the corresponding option is activated.
s*	System-specific channel, only available if the corresponding option is activated

## Arrangement 2: Solar system with heat exchange

The controller calculates the temperature difference between collector sensor S1 and store sensor S2. If the difference is larger than or identical to the adjusted switch-on temperature difference (DTO), the solar pump will be activated by relay 1, and the store will be loaded until the switch-off temperature difference (DTF) or the maximum store temperature (S MX) is reached.

Heat exchange from store 1 to store 2 will be operated by relay 2, if the temperature difference between sensors S3 and S4 is larger than or identical to the adjusted switch-on temperature difference (DT3O), until the adjusted minimum (MN3O) and maximum (MX3O) temperature thresholds of the respective stores are reached. S3 can optionally be used as the reference sensor for the store emergency shutdown option (OSEM).

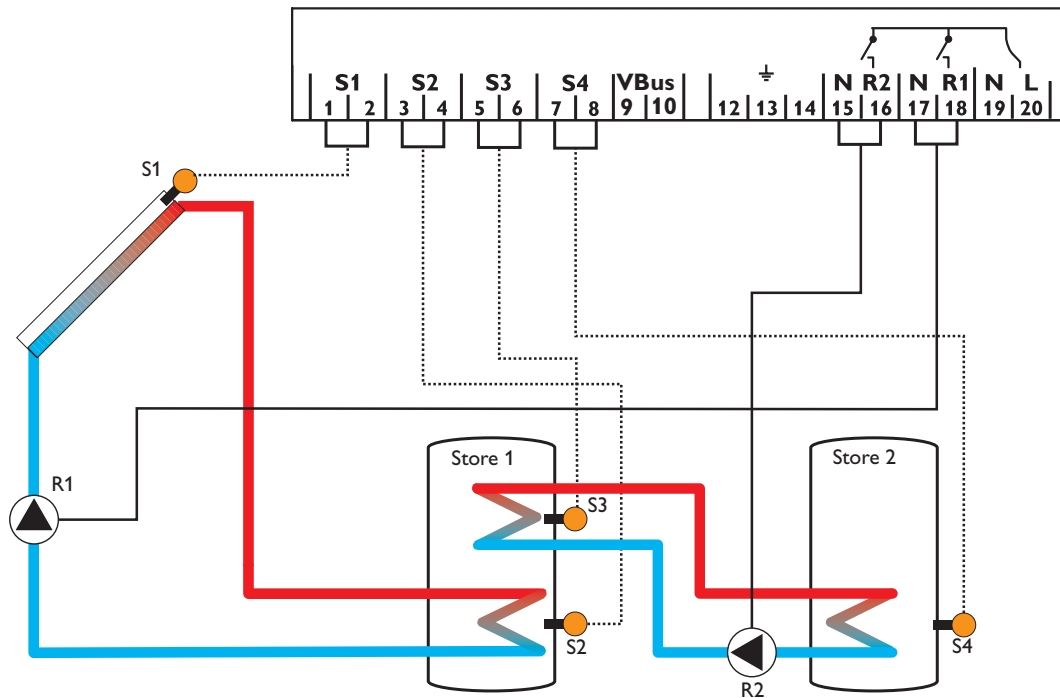
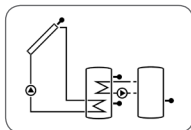

Display channels				
Channel		Description	Connection terminal	Page
INIT	x*	ODB initialisation active	-	38
FLL	x*	ODB filling time active	-	38
STAB	x*	ODB stabilisation in progress	-	38
COL	x	Temperature collector	S1	38
TST1	x	Temperature store 1 base	S2	38
TSTT	x	Temperature store 1 top	S3	38
TST2	x	Temperature store 2 base	S4	38
n1 %	x	Speed R1	R1	39
n2 %	x	Speed R2	R2	39
h P1	x	Operating hours R1	R1	40
h P2	x	Operating hours R2	R2	40
TIME	x	Time	-	40

Adjustment channels				
Channel		Description	Factory setting	Page
Arr	x	System	2	41
DT O	x	Switch-on temperature difference	6.0 K [12.0 °Ra]	41
DT F	x	Switch-off temperature difference	4.0 K [8.0 °Ra]	41
DT S	x	Set temperature difference	10.0 K [20.0 °Ra]	42
RIS	x	Rise R1	2 K [4 °Ra]	42
n1MN	x	Minimum speed R1	30 %	42
S MX	x	Maximum store temperature	60 °C [140 °F]	42
OSEM	x	Store emergency shutdown option	OFF	43
n2MN	s	Minimum speed R2	30 %	42
EM	x	Collector emergency temperature	130 °C [270 °F]	43
		Collector emergency temperature, if OBST is activated:	95 °C [200 °F]	43
OCC	x	Collector cooling option	OFF	43
CMX	x*	Maximum collector temperature	110 °C [230 °F]	43
OSYC	x	System cooling option	OFF	44
DTCO	x*	Switch-on temperature difference cooling	20.0 K [40.0 °Ra]	44
DTCF	x*	Switch-off temperature difference cooling	15.0 K [30.0 °Ra]	44
OSTC	x	Store cooling option	OFF	44
OHOL	x*	Holiday cooling option	OFF	44
THOL	x*	Holiday cooling temperature	40 °C [110 °F]	44
OCN	x	Collector minimum limitation option	OFF	45
CMN	x*	Collector minimum temperature	10 °C [50 °F]	45
OCF	x	Antifreeze option	OFF	45

Adjustment channels				
Channel		Description	Factory setting	Page
CFR	x*	Antifreeze temperature	4.0 °C [40.0 °F]	45
OTC	x	Tube collector option	OFF	47
TCST	x*	OTC starting time	07:00	47
TCEN	x*	OTC ending time	19:00	47
TCRU	x*	OTC runtime	30 s	47
TCIN	x*	OTC standstill interval	30 min	47
DT3O	s	Switch-on temperature difference 3	6.0 K [12.0 °Ra]	41
DT3F	s	Switch-off temperature difference 3	4.0 K [8.0 °Ra]	41
DT3S	s	Set temperature difference 3	10.0 K [20.0 °Ra]	42
RIS3	s	Rise R2	2 K [4 °Ra]	42
MX3O	s	Switch-on threshold for maximum temperature	60.0 °C [140.0 °F]	29
MX3F	s	Switch-off threshold for maximum temperature	58.0 °C [136.0 °F]	29
MN3O	s	Switch-on threshold for minimum temperature	5.0 °C [40.0 °F]	29
MN3F	s	Switch-off threshold for minimum temperature	10.0 °C [50.0 °F]	29
ODB	x	Drainback option	OFF	48
tDTO	x*	ODB switch-on condition - time period	60 s	48
rFL	x*	ODB filling time	5.0 min	49
tSTB	x*	ODB stabilisation time	2.0 min	49
MAN1	x	Manual mode R1	Auto	49
MAN2	x	Manual mode R2	Auto	49
ADA1	x	HE pump control	OFF	49
ADA2	x	HE pump control	OFF	49
LANG	x	Language	dE	50
UNIT	x	Temperature unit	°C	50
RESE	x	Reset - back to factory settings		50
#####		Version number		

### Legend:

Symbol	Description
x	Channel is available
x*	Channel is available, if the corresponding option is activated.
s*	System-specific channel, only available if the corresponding option is activated

## System-specific functions

The following adjustments are used for the specific functions in system 2.

### $\Delta T$ control for the heat exchange between 2 stores



#### DT30

Switch-on temperature difference

Adjustment range:

1.0 ... 20.0 K [2.0 ... 40.0 °Ra]

Factory setting: 6.0 K [12.0 °Ra]



#### DT3F

Switch-off temperature difference

Adjustment range:

0.5 ... 19.5 K [1.0 ... 39.0 °Ra]

Factory setting: 4.0 K [8.0 °Ra]

### S3 and S4 are used as the reference sensors for this function.

In system 2 the controller is equipped with an additional differential control for heat exchange between two stores. The basic differential function is adjusted using the switch-on (**DT30**) and switch-off (**DT3F**) temperature differences.

When the temperature difference exceeds the adjusted switch-on temperature difference, relay 2 switches on. When the temperature difference falls below the adjusted switch-off temperature difference, relay 2 switches off.



#### Note

The switch-on temperature difference must be at least 0.5 K [1 °Ra] higher than the switch-off temperature difference.

### Speed control

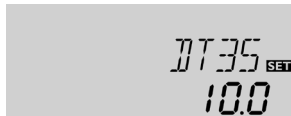

#### DT3S

Set temperature difference

Adjustment range:

1.5 ... 30.0 K [3.0 ... 60.0 °Ra]

Factory setting: 10.0 K [20.0 °Ra]



#### RIS3

Rise

Adjustment range: 1 ... 20 K [2 ... 40 °Ra]

Factory setting: 2 K [4 °Ra]

If the temperature difference reaches or exceeds the switch-on temperature difference, the pump switches on at 100% speed for 10 s. Then, the speed is reduced to the minimum pump speed value.

If the temperature difference reaches the adjusted set value, the pump speed increases by one step (10%). The response of the controller can be adapted via the parameter Rise. Each time the difference increases by the adjustable rise value, the pump speed increases by 10% until the maximum pump speed of 100% is reached. If the temperature difference decreases by the adjustable rise value, pump speed will be decreased by one step.



#### Note

For pump speed control of the heat exchange pump, the operating mode of relay 2 must be set to **Auto** in the adjustment channel **MAN2**.



#### Note

The set temperature difference must be at least 0.5 K [1 °Ra] higher than the switch-on temperature difference.

## Minimum speed

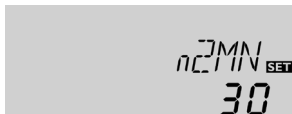

### n2MN

Minimum speed

Adjustment range: 30 ... 100%

Factory setting: 30%

In the adjustment channel **n2MIN** a relative minimum speed for a pump connected can be allocated to the output R2.



### Note

When loads which are not speed-controlled (e. g. valves) are used, the value **n2MN** must be set to 100% to deactivate pump speed control.

## Maximum temperature limitation heat exchange

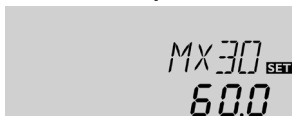

### MX3O

Maximum temperature limitation

Adjustment range: 0.0 ... 95.0 °C [30.0 ... 200.0 °F]

Factory setting:

MX3O: 60.0 °C [140.0 °F]

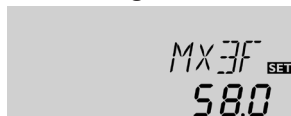

### MX3F

MX3F: 58.0 °C [136.0 °F]

Minimum and maximum temperature limits can be set for the heat exchange function.

**S4 is used as the reference sensor for the maximum temperature limitation.**

The maximum temperature limitation function provides a maximum temperature setting, usually to reduce scald risk in a store. If **MX3O** is exceeded, relay 2 is switched off until the temperature at sensor 4 falls below **MX3F**.

## Minimum temperature limitation heat exchange



### MN3O

Minimum temperature limitation

Adjustment range: 0.0 ... 90.0 °C [30.0 ... 190.0 °F]

Factory setting: (only if Arr = 2):

MN3O: 5.0 °C [40.0 °F]



### MN3F

MN3F: 10.0 °C [50.0 °F]

**S3 is used as the reference sensor for the minimum temperature limitation.**

The minimum temperature limitation function provides a minimum temperature setting for the heat source in system 2. If the temperature at sensor 3 falls below **MN3O**, relay 2 is switched off until the temperature at sensor 3 exceeds **MN3F**.

Both switch-on and switch-off temperature differences **DT3O** and **DT3F** are valid for the maximum and minimum temperature limitation.

### Arrangement 3: Solar system with afterheating

The controller calculates the temperature difference between collector sensor S1 and store sensor S2. If the difference is larger than or identical to the adjusted switch-on temperature difference (DTO), the solar pump will be activated by relay 1, and the store will be loaded until the switch-off temperature difference (DTF) or the maximum store temperature (S MX) is reached.

Sensor S3 is used for a thermostat function, which operates relay 2 for afterheating or heat dump purposes, when the adjusted thermostat switch-on temperature (AHO) is reached. This function can optionally be combined with up to three adjustable time frames.

Sensor S3 can optionally be used as the reference sensor for the thermal disinfection function (OTD) or the store emergency shutdown option (OSEM).

Sensor S4 can optionally be connected for measurement purposes. If heat quantity measurement (OHQM) is activated, S4 is to be used as the return sensor.

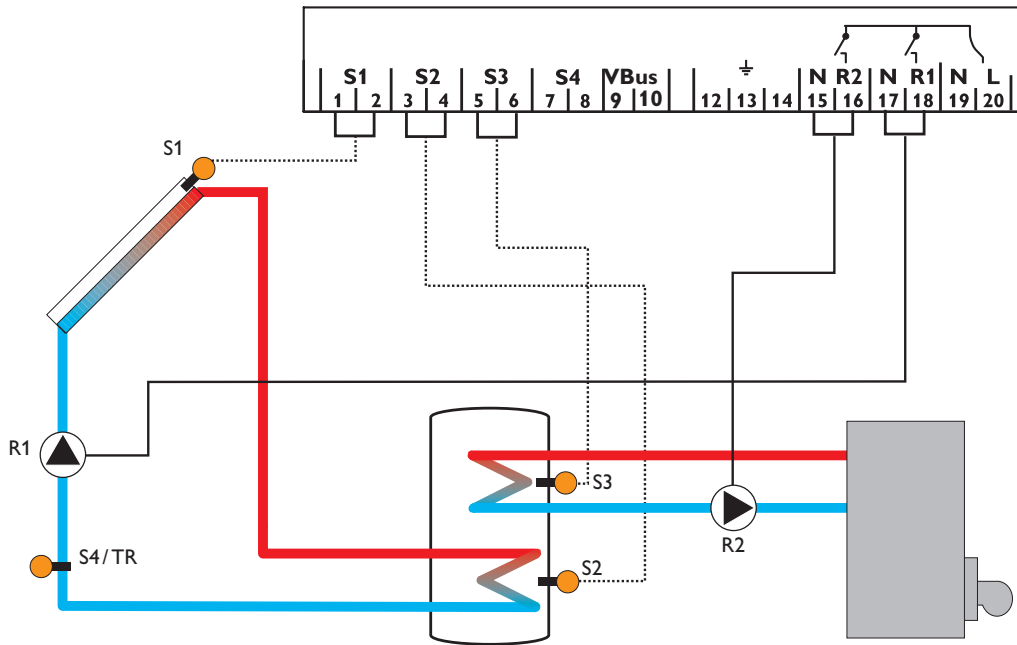
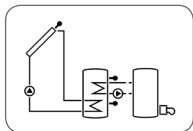

Display channels			
Channel	Description	Connection terminal	Page
INIT	x* ODB initialisation active	-	38
FLL	x* ODB filling time active	-	38
STAB	x* ODB stabilisation in progress	-	38
COL	x Temperature collector	S1	38
TSTB	x Temperature store 1 base	S2	38
TSTT	x Temperature store 1 top	S3	38
TDIS	s* Thermal disinfection temperature (thermal disinfection)	S3	17
S4	x Temperature sensor 4	S4	39
TR	x* Temperature return sensor	S4	38
n1 %	x Speed R1	R1	39
h P1	x Operating hours R1	R1	40
h P2	x Operating hours R2	R2	40
kWh	x* Heat quantity in kWh	-	39
MWh	x* Heat quantity in MWh	-	39
CDIS	s* Countdown of monitoring period (thermal disinfection)	-	40
SDIS	s* Starting time display (thermal disinfection)	-	39
DDIS	s* Heating period display (thermal disinfection)	-	39
TIME	x Time	-	40

Adjustment channels			
Channel	Description	Factory setting	Page
Arr	x System	3	41
DT O	x Switch-on temperature difference	6.0 K [12.0 °Ra]	41
DT F	x Switch-off temperature difference	4.0 K [8.0 °Ra]	41
DT S	x Set temperature difference	10.0 K [20.0 °Ra]	42
RIS	x Rise R1	2 K [4 °Ra]	42
n1MN	x Minimum speed R1	30 %	42
S MX	x Maximum store temperature	60 °C [140 °F]	42
OSEM	x Store emergency shutdown option	OFF	43
EM	x Collector emergency temperature	130 °C [270 °F]	43
	x Collector emergency temperature, if OBST is activated:	95 °C [200 °F]	43
OCC	x Collector cooling option	OFF	43
CMX	x* Maximum collector temperature	110 °C [230 °F]	43
OSYC	x System cooling option	OFF	44
DTCO	x* Switch-on temperature difference cooling	20.0 K [40.0 °Ra]	44
DTCF	x* Switch-off temperature difference cooling	15.0 K [30.0 °Ra]	44
OSTC	x Store cooling option	OFF	44
OHOL	x* Holiday cooling option	OFF	44
THOL	x* Holiday cooling temperature	40 °C [110 °F]	44

Adjustment channels			
Channel	Description	Factory setting	Page
OCN	x Collector minimum limitation option	OFF	45
CMN	x* Collector minimum temperature	10 °C [50 °F]	45
OCF	x Antifreeze option	OFF	45
CFR	x* Antifreeze temperature	4.0 °C [40.0 °F]	45
OTC	x Tube collector option	OFF	47
TCST	x* OTC starting time	07:00	47
TCEN	x* OTC ending time	19:00	47
TCRU	x* OTC runtime	30 s	47
TCIN	x* OTC standstill interval	30 min	47
OHQM	x Heat quantity measurement option	OFF	47
FMAX	x* Maximum flow rate	6.0 l	47
MEDT	x* Heat transfer fluid /Antifreeze type	1	48
MED%	x* Antifreeze concentration	45 %	48
AH O	s Switch-on temperature for thermostat 1	40 °C [110 °F]	16
AHF	s Switch-off temperature for thermostat 1	45 °C [120 °F]	16
t1 O	s Thermostat switch-on time 1	00:00	16
t1 F	s Thermostat switch-off time 1	00:00	16
t2 O	s Thermostat switch-on time 2	00:00	16
t2 F	s Thermostat switch-off time 2	00:00	16
t3 O	s Thermostat switch-on time 3	00:00	16
t3 F	s Thermostat switch-off time 3	00:00	16
ODB	x Drainback option	OFF	48
tDTO	x* ODB switch-on condition - time period	60 s	48
tFLL	x* ODB filling time	5.0 min	49
tSTB	x* ODB stabilisation time	2.0 min	49
OTD	s Thermal disinfection option	OFF	17
PDIS	s* Monitoring period	01:00	17
DDIS	s* Heating period	01:00	17
TDIS	s* Disinfection temperature	60 °C [140 °F]	17
SDIS	s* Starting time	00:00	17
MAN1	x Manual mode R1	Auto	49
MAN2	x Manual mode R2	Auto	49
ADA1	x HE pump control	OFF	49
LANG	x Language	dE	50
UNIT	x Temperature unit	°C	50
RESE	x Reset - back to factory settings		50
#####	Version number		

### Legend:

Symbol	Description
x	Channel is available
x*	Channel is available, if the corresponding option is activated
s	System-specific channel
s*	System-specific channel, only available if the corresponding option is activated

## System-specific functions

The following adjustments are used for the specific functions in system 3. The channels described are not available in any other system.

### Thermostat function

Afterheating

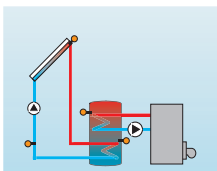

Use of surplus energy

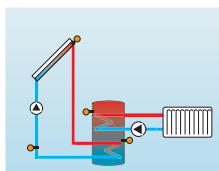

The thermostat function works independently from the solar operation and can be used for using surplus energy or for afterheating.

- **AHO < AHF**  
thermostat function for afterheating
- **AHO > AHF**  
thermostat function for using surplus energy

The symbol  will be shown on the display, if the second relay output is activated.

**S3 is used as the reference sensor for the thermostat function.**



#### AH O

Thermostat switch-on temperature  
Adjustment range:  
0.0 ... 95.0 °C [30.0 ... 200.0 °F]  
Factory setting: 40.0 °C [110.0 °F]

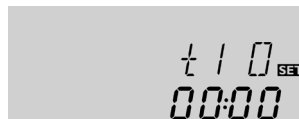

#### t1 O, t2 O, t3 O

Thermostat switch-on time  
Adjustment range: 00:00 ... 23:45  
Factory setting: 00:00



#### AHF

Thermostat switch-off temperature  
Adjustment range:  
0.0 ... 95.0 °C [30.0 ... 200.0 °F]  
Factory setting: 45.0 °C [120.0 °F]



#### t1 F, t2 F, t3 F

Thermostat switch-off time  
Adjustment range: 00:00 ... 23:45  
Factory setting: 00:00

In order to block the thermostat function for a certain period, there are 3 time frames t1 ... t3.

If the thermostat function is supposed to run from 06:00 a.m. to 09:00 a.m. only, adjust **t1 O** to 06:00 a.m. and **t1 F** to 09:00 a.m.

If the switch-on and switch-off times of a time frame are set to an identical value, the time frame will be inactive. If all time frames are set to 00:00, the thermostat function is solely temperature dependent (factory setting).



## Thermal disinfection of the upper DHW zone



### OTD

Therm. disinfection function  
Adjustment range: OFF/ON  
Factory setting: OFF



### PDIS

Monitoring period  
Adjustment range:  
0 ... 30:0 ... 24 h (dd:hh)  
Factory setting: 01:00

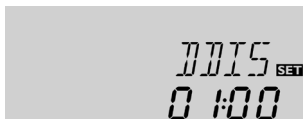

### DDIS

Disinfection period  
Adjustment range: 0:00 ... 23:59 (hh:mm)  
Factory setting: 01:00



### TDIS

Disinfection temperature  
Adjustment range:  
0 ... 95 °C [30 ... 200 °F]  
Factory setting: 60 °C [140 °F]

### Reference sensor for this function is S3.

This function helps to contain the spread of Legionella in DHW stores by systematically activating the afterheating.

For thermal disinfection, the temperature at the reference sensor will be monitored. Protection is ensured when, during the monitoring period, the disinfection temperature is continuously exceeded for the entire disinfection period.

The monitoring period starts as soon as the temperature at the reference sensor falls below the disinfection temperature. When the monitoring period ends, the allocated reference relay activates the afterheating. The disinfection period starts, if the temperature at the allocated sensor exceeds the disinfection temperature.

Thermal disinfection can only be completed when the disinfection temperature is exceeded for the duration of the disinfection period without any interruption.

## Starting time delay

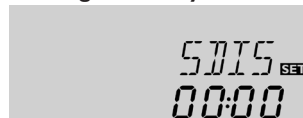

### SDIS

Starting time  
Adjustment range: 0:00 ... 24:00 (time)  
Factory setting: 00:00

If the starting delay option is activated, a starting time for the thermal disinfection with starting delay can be adjusted. The activation of the afterheating is then delayed until that starting time after the monitoring period has ended.

If the monitoring period ends, for example, at 12:00 o'clock, and the starting time has been set to 18:00, the reference relay will be energised with a delay of 6 hours at 18:00 instead of 12:00 o'clock.



### Note

If the thermal disinfection option is activated, the display channels **TDIS**, **CDIS**, **SDIS** and **DDIS** will be displayed.

#### Arrangement 4: Solar system with store loading in layers

The controller calculates the temperature difference between collector sensor S1 and store sensors S2 and S3. If the difference is larger than or identical to the corresponding adjusted switch-on temperature differences (DT1O/DT2O), the solar pump will be activated by relay 1, and the corresponding store zone will be loaded until the switch-off temperature difference (DT1F/DT2F) or the maximum store temperature (S1MX/S2MX) is reached. The priority logic causes priority loading of the upper store zone, if possible. In that case, the 3-port valve will be operated by relay 2.

Sensor S4 can optionally be connected for measurement purposes.

If heat quantity measurement (OHQM) is activated, S4 is to be used as the return sensor.

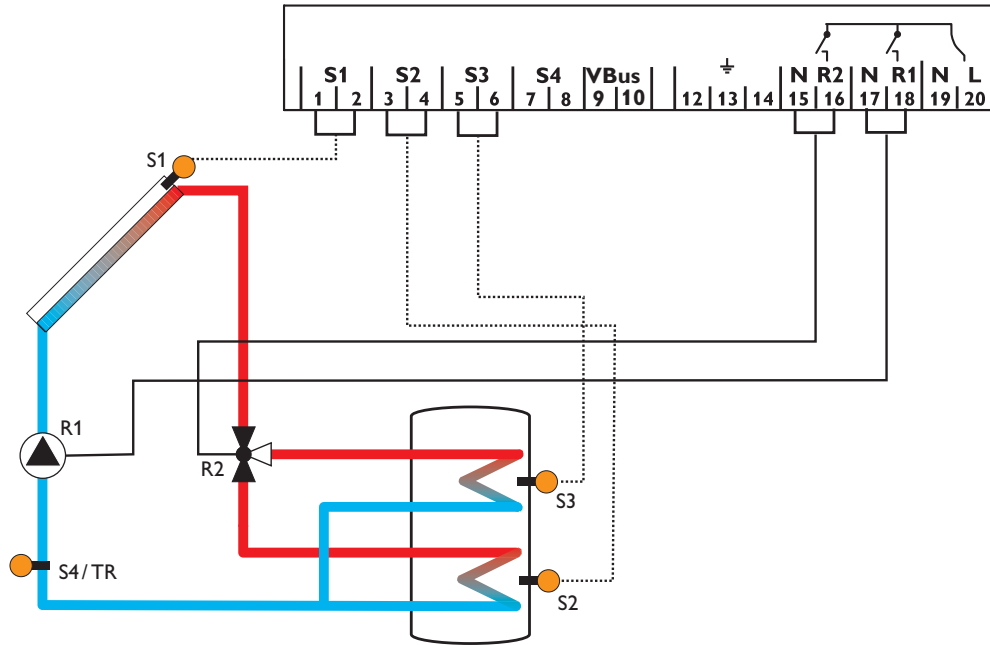
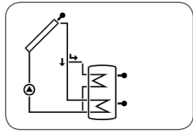

Display channels				
Channel		Description	Connection terminal	Page
COL	x	Temperature collector	S1	38
TSTB	x	Temperature store 1 base	S2	38
TSTT	x	Temperature store 1 top	S3	38
S4	x	Temperature store 4	S4	39
TR	x*	Temperature return sensor	S4	38
n %	x	Speed relay	R1	39
hP1	x	Operating hours R1	R1	40
hP2	x	Operating hours R2	R2	40
kWh	x*	Heat quantity in kWh	-	39
MWh	x*	Heat quantity in MWh	-	39
TIME	x	Time	-	40

Adjustment channels				
Channel		Description	Factory setting	Page
Arr	x	System	4	41
nMN	x	Minimum speed	30%	42
DT1O	x	Switch-on temperature difference 1	6.0K [12.0 °Ra]	41
DT1F	x	Switch-off temperature difference 1	4.0K [8.0 °Ra]	41
DT1S	x	Set temperature difference 1	10.0K [20.0 °Ra]	42
RIS1	x	Rise R1	2K [4 °Ra]	42
S1 MX	x	Maximum store temperature 1	60 °C [140 °F]	42
DT2O	x	Switch-on temperature difference 2	6.0K [12.0 °Ra]	41
DT2F	x	Switch-off temperature difference 2	4.0K [8.0 °Ra]	41
DT2S	x	Set temperature difference 2	10.0K [20.0 °Ra]	42
RIS3	x	Rise R2	2K [4 °Ra]	42
S2MX	x	Maximum store temperature 2	60 °C [140 °F]	42
EM	x	Collector emergency temperature	130 °C [270 °F]	43
OCC	x	Collector cooling option	OFF	43
CMX	x*	Maximum collector temperature	110 °C [230 °F]	43
OSYC	x	System cooling option	OFF	44
DTCO	x*	Switch-on temperature difference cooling	20.0K [40.0 °Ra]	44
DTCF	x*	Switch-off temperature difference cooling	15.0K [30.0 °Ra]	44
OSTC	x	Store cooling option	OFF	44
OHOL	x*	Holiday cooling option	OFF	44
THOL	x*	Holiday cooling temperature	40 °C [110 °F]	44
OCN	x	Collector minimum limitation option	OFF	45
CMN	x*	Collector minimum temperature	10 °C [50 °F]	45

Adjustment channels				
Channel		Description	Factory setting	Page
OCF	x	Antifreeze option	OFF	45
CFR	x*	Antifreeze temperature	4.0 °C [40.0 °F]	45
PRIO	x	Priority	2	46
rLB	x	Loading break (store sequence control)	2 min	46
tRUN	x	Circulation time (store sequence control)	15 min	46
OTC	x	Tube collector option	OFF	47
TCST	x*	OTC starting time	07:00	47
TCEN	x*	OTC ending time	19:00	47
TCRU	x*	OTC runtime	30 s	47
TCIN	x*	OTC standstill interval	30 min	47
OHQM	x	Heat quantity measurement option	OFF	47
FMAX	x*	Maximum flow rate	6.0 l	47
MEDT	x*	Heat transfer fluid/Antifreeze type	1	48
MED%	x*	Antifreeze concentration (only if MEDT = propylene or ethylene)	45 %	48
MAN1	x	Manual mode R1	Auto	49
MAN2	x	Manual mode R2	Auto	49
ADA1	x	HE pump control	OFF	49
LANG	x	Language	dE	50
UNIT	x	Temperature unit	°C	50
RESE	x	Reset - back to factory settings		50
#####		Version number		

### Legend:

Symbol	Description
x	Channel is available
x*	Channel is available, if the corresponding option is activated.

## Arrangement 5: Solar system with 2 stores and valve logic

The controller calculates the temperature difference between collector sensor S1 and store sensors S2 and S3. If the difference is larger than or identical to the corresponding adjusted switch-on temperature differences (DT1O/DT2O), the solar pump will be activated by relay 1, and the corresponding store will be loaded until the switch-off temperature difference (DT1F/DT2F) or the maximum store temperature (S1MX/S2MX) is reached. The priority logic causes priority loading of store 1. If store 2 is being loaded, relay 2 switches the 3-port valve.

Sensor S4 can optionally be connected for measurement purposes.

If heat quantity measurement (OHQM) is activated, S4 is to be used as the return sensor.

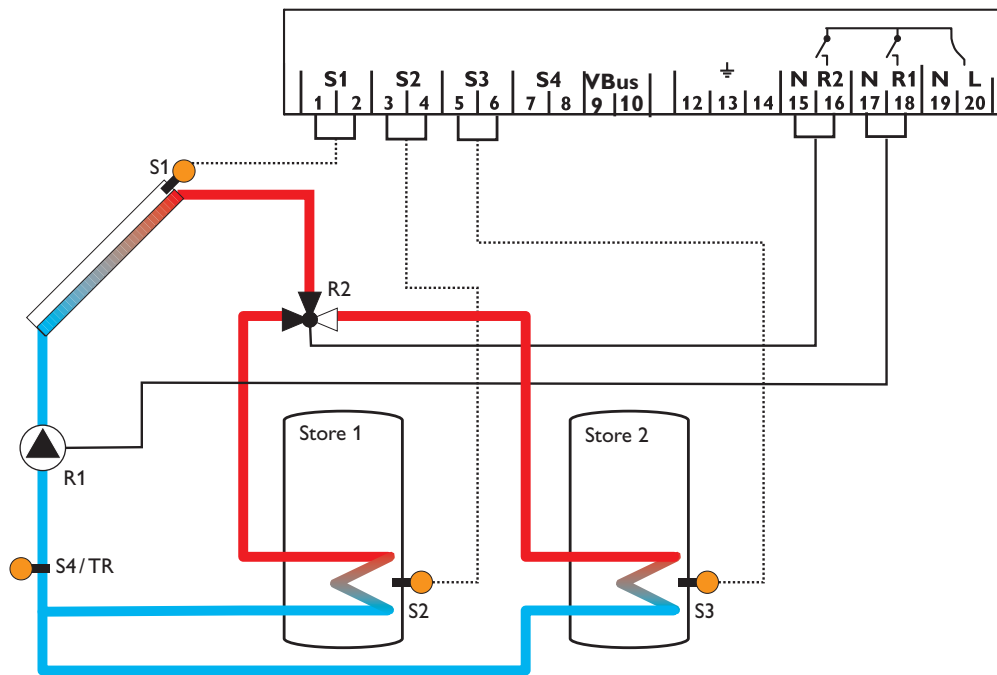
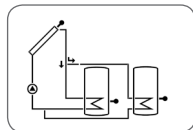

Display channels				
Channel		Description	Connection terminal	Page
COL	x	Temperature collector	S1	38
TST1	x	Temperature store 1 base	S2	38
TST2	x	Temperature store 2 base	S3	38
S4	x	Temperature sensor 4	S4	39
TR	x*	Temperature return sensor	S4	38
n %	x	Speed relay	R1	39
hP1	x	Operating hours R1	R1	40
hP2	x	Operating hours R2	R2	40
kWh	x*	Heat quantity in kWh	-	39
MWh	x*	Heat quantity in MWh	-	39
TIME	x	Time	-	40

Adjustment channels				
Channel		Description	Factory setting	Page
Arr	x	System	5	41
nMN	x	Minimum speed	30%	42
DT1O	x	Switch-on temperature difference 1	6.0K [12.0 °Ra]	41
DT1F	x	Switch-off temperature difference 1	4.0K [8.0 °Ra]	41
DT1S	x	Set temperature difference 1	10.0K [20.0 °Ra]	42
RIS1	x	Rise R1	2K [4 °Ra]	42
S1 MX	x	Maximum store temperature 1	60 °C [140 °F]	42
DT2O	x	Switch-on temperature difference 2	6.0K [12.0 °Ra]	41
DT2F	x	Switch-off temperature difference 2	4.0K [8.0 °Ra]	41
DT2S	x	Set temperature difference 2	10.0K [20.0 °Ra]	42
RIS2	x	Rise R2	2K [4 °Ra]	42
S2MX	x	Maximum store temperature 2	60 °C [140 °F]	42
EM	x	Collector emergency temperature	130 °C [270 °F]	43
OCC	x	Collector cooling option	OFF	43
CMX	x*	Maximum collector temperature	110 °C [230 °F]	43
OSYC	x	System cooling option	OFF	44
DTCO	x*	Switch-on temperature difference cooling	20.0K [40.0 °Ra]	44
DTCF	x*	Switch-off temperature difference cooling	15.0K [30.0 °Ra]	44
OSTC	x	Store cooling option	OFF	44
OHOL	x*	Holiday cooling option	OFF	44
THOL	x*	Holiday cooling temperature	40 °C [110 °F]	44
OCN	x	Collector minimum limitation option	OFF	45
CMN	x*	Collector minimum temperature	10 °C [50 °F]	45

Adjustment channels				
Channel		Description	Factory setting	Page
OCF	x	Antifreeze option	OFF	45
CFR	x*	Antifreeze temperature	4.0 °C [40.0 °F]	45
PRIO	x	Priority	1	46
rLB	x	Loading break (store sequence control)	2 min	46
tRUN	x	Circulation time (store sequence control)	15 min	46
OTC	x	Tube collector option	OFF	47
TCST	x*	OTC starting time	07:00	47
TCEN	x*	OTC ending time	19:00	47
TCRU	x*	OTC runtime	30 s	47
TCIN	x*	OTC standstill interval	30 min	47
OHQM	x	Heat quantity measurement option	OFF	47
FMAX	x*	Maximum flow rate	6.0 l	47
MEDT	x*	Heat transfer fluid/Antifreeze type	1	48
MED%	x*	Antifreeze concentration (only if MEDT = propylene or ethylene glycol)	45 %	48
MAN1	x	Manual mode R1	Auto	49
MAN2	x	Manual mode R2	Auto	49
ADA1	x	HE pump control	OFF	49
LANG	x	Language	dE	50
UNIT	x	Temperature unit	°C	50
RESE	x	Reset - back to factory settings		50
#####		Version number		

#### Legend:

Symbol	Description
x	Channel is available
x*	Channel is available, if the corresponding option is activated.

## Arrangement 6: Solar system with 2 stores and pump logic

The controller calculates the temperature difference between collector sensor S1 and store sensors S2 and S3. If the difference is larger than or identical to the corresponding adjusted switch-on temperature differences (DT1O/DT2O), one or both solar pumps will be activated by relay 1 and/or relay 2, and the corresponding store will be loaded until the switch-off temperature difference (DT1F/DT2F) or the maximum store temperature (S1MX/S2MX) is reached. The priority logic causes priority loading of the store selected in the PRIO channel, if possible.

If PRIO = 0, both stores will be loaded simultaneously.

Sensor S4 can optionally be used for measurement purposes or as the reference sensor for the store emergency shutdown option (OSEM).

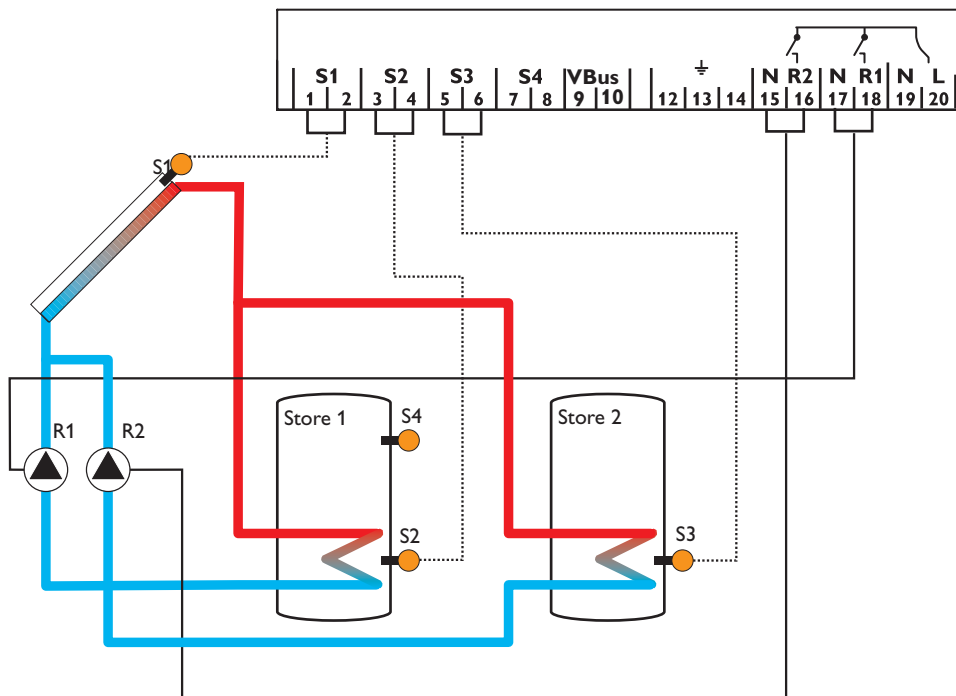
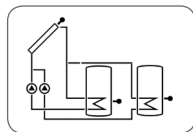

Display channels			
Channel		Description	Connection terminal Page
COL	x	Temperature collector	S1 38
TST1	x	Temperature store 1 base	S2 38
TST2	x	Temperature store 2 base	S3 38
S4	x	Temperature sensor 4	S4 39
TSTT	x*	Temperature store top	S4 38
n1 %	x	Speed R1	R1 39
n2 %	x	Speed R2	R2 39
h P1	x	Operating hours R1	R1 39
h P2	x	Operating hours R2	R2 39
TIME	x	Time	- 40

Adjustment channels			
Channel		Description	Factory setting Page
Arr	x	System	6 41
DT1O	x	Switch-on temperature difference 1	6.0K [12.0 °Ra] 41
DT1F	x	Switch-off temperature difference 1	4.0K [8.0 °Ra] 41
DT1S	x	Set temperature difference 1	10.0K [20.0 °Ra] 42
RIS1	x	Rise R1	2K [4 °Ra] 42
n1MN	x	Minimum speed R1	30% 42
S1 MX	x	Maximum store temperature 1	60 °C [140 °F] 42
OSEM	x	Store emergency shutdown option	OFF 42
DT2O	x	Switch-on temperature difference 2	6.0K [12.0 °Ra] 41
DT2F	x	Switch-off temperature difference 2	4.0K [8.0 °Ra] 41
DT2S	x	Set temperature difference 2	10.0K [20.0 °Ra] 42
RIS2	x	Rise R2	2K [4 °Ra] 42
n2MN	x	Minimum speed R2	30% 42
S2MX	x	Maximum store temperature 2	60 °C [140 °F] 42
EM	x	Collector emergency temperature	130 °C [270 °F] 43
OCC	x	Collector cooling option	OFF 43
CMX	x*	Maximum collector temperature	110 °C [230 °F] 43
OSYC	x	System cooling option	OFF 44
DTCO	x*	Switch-on temperature difference cooling	20.0K [40.0 °Ra] 44
DTCF	x*	Switch-off temperature difference cooling	15.0K [30.0 °Ra] 44
OSTC	x	Store cooling option	OFF 44
OHOL	x*	Holiday cooling option	OFF 44
THOL	x*	Holiday cooling temperature	40 °C [110 °F] 44
OCN	x	Collector minimum limitation option	OFF 45

Adjustment channels			
Channel		Description	Factory setting Page
CMN	x*	Collector minimum temperature	10 °C [50 °F] 45
OCF	x	Antifreeze option	OFF 45
CFR	x*	Antifreeze temperature	4.0 °C [40.0 °F] 45
PRIO	x	Priority	1 46
tLB	x	Loading break (store sequence control)	2 min 46
tRUN	x	Circulation time (store sequence control)	15 min 46
DTSE	x*	Spread temperature difference	40K [70 °Ra] 46
OTC	x	Tube collector option	OFF 47
TCST	x*	OTC starting time	07:00 47
TCEN	x*	OTC ending time	19:00 47
TCRU	x*	OTC runtime	30 s 47
TCIN	x*	OTC standstill interval	30 min 47
MAN1	x	Manual mode R1	Auto 49
MAN2	x	Manual mode R2	Auto 49
ADA1	x	HE pump control	OFF 49
ADA2	x	HE pump control	OFF 49
LANG	x	Language	dE 50
UNIT	x	Temperature unit	°C 50
RESE	x	Reset - back to factory settings	50
#####		Version number	

#### Legend:

Symbol	Description
x	Channel is available
x*	Channel is available, if the corresponding option is activated.

## Arrangement 7: Solar system with east-/west collectors and 1 store

The controller calculates the temperature difference between collector sensors S1 and S3 and store sensor S2. If the differences are larger than or identical to the adjusted switch-on temperature difference (DTO), one or both pumps will be activated by relay 1 and/or relay 2, and the store will be loaded until the switch-off temperature difference (DTF) or the maximum store temperature (SMX) is reached.

Sensor S4 can optionally be used for measurement purposes or as the reference sensor for the store emergency shutdown option (OSEM).

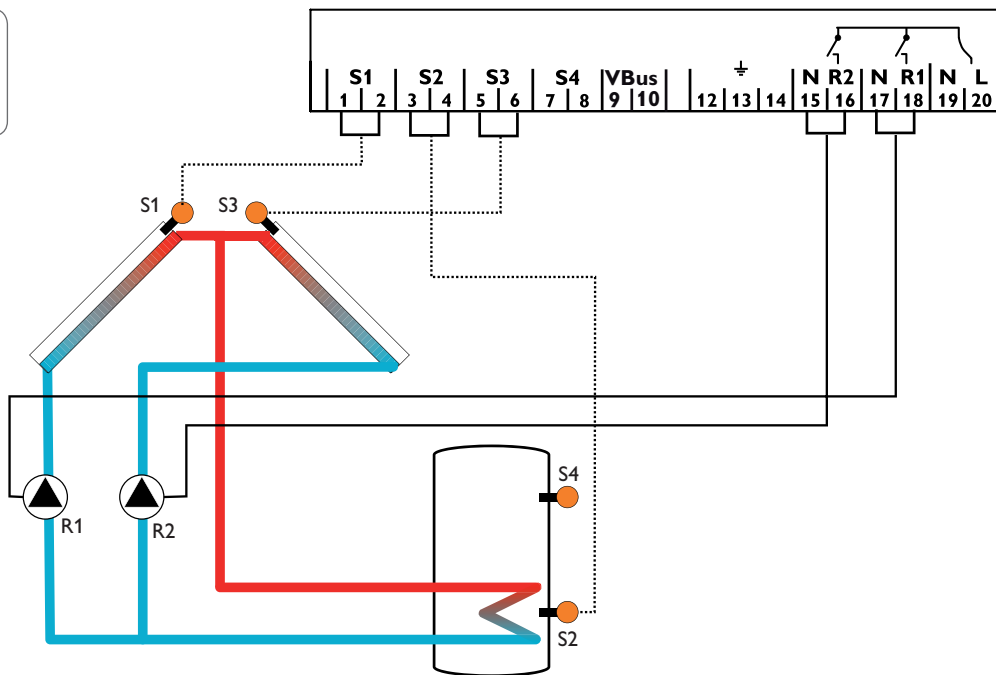
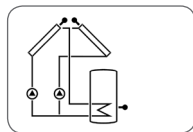



Display channels				
Channel		Description	Connection terminal	Page
COL1	x	Temperature collector 1	S1	38
TST	x	Temperature store	S2	38
COL2	x	Temperature collector 2	S3	38
S4	x	Temperature sensor 4	S4	39
TSTT	x*	Temperature store top	S4	38
n1 %	x	Speed R1	R1	39
n2 %	x	Speed R2	R2	39
h P1	x	Operating hours R1	R1	39
h P2	x	Operating hours R2	R2	39
TIME	x	Time	-	40

Adjustment channels				
Channel		Description	Factory setting	Page
Arr	x	System	7	41
DT O	x	Switch-on temperature difference	6.0K [12.0 °Ra]	41
DT F	x	Switch-off temperature difference	4.0K [8.0 °Ra]	41
DT S	x	Set temperature difference	10.0K [20.0 °Ra]	42
RIS	x	Rise R1/R2	2K [4 °Ra]	42
n1MN	x	Minimum speed R1	30%	42
S MX	x	Maximum store temperature	60 °C [140 °F]	42
OSEM	x	Store emergency shutdown option	OFF	43
n2MN	x	Minimum speed R2	30%	42
EM1	x	Collector emergency temperature 1	130 °C [270 °F]	43
EM2	x	Collector emergency temperature 2	130 °C [270 °F]	43
OCC1	x	Collector cooling option collector 1	OFF	43
CMX1	x*	Maximum collector temperature 1	110 °C [230 °F]	43
OCC2	x	Collector cooling option collector 2	OFF	43
CMX2	x*	Maximum collector temperature 2	110 °C [230 °F]	43
OSYC	x	System cooling option	OFF	44
DTCO	x*	Switch-on temperature difference cooling	20.0K [40.0 °Ra]	44
DTCF	x*	Switch-off temperature difference cooling	15.0K [30.0 °Ra]	44
OSTC	x	Store cooling option	OFF	44
OHOL	x*	Holiday cooling option	OFF	44
THOL	x*	Holiday cooling temperature	40 °C [110 °F]	44
OKN1	x	Collector minimum limitation collector 1	OFF	45
CMN1	x*	Minimum collector temperature 1	10 °C [50 °F]	45
OCN2	x	Collector minimum limitation collector 2	OFF	45

Adjustment channels				
Channel		Description	Factory setting	Page
CMN2	x*	Minimum collector temperature 2	10 °C [50 °F]	45
OCF1	x	Antifreeze option collector 1	OFF	45
CFR1	x*	Antifreeze temperature collector 1	4.0 °C [40.0 °F]	45
OCF2	x	Antifreeze option collector 2	OFF	45
CFR2	x*	Antifreeze temperature collector 2	4.0 °C [40.0 °F]	45
OTC	x	Tube collector option	OFF	47
TCST	x*	OTC starting time	07:00	47
TCEN	x*	OTC ending time	19:00	47
TCRU	x*	OTC runtime	30 s	47
TCIN	x*	OTC standstill interval	30 min	47
MAN1	x	Manual mode R1	Auto	49
MAN2	x	Manual mode R2	Auto	49
ADA1	x	HE pump control	OFF	49
ADA2	x	HE pump control	OFF	49
LANG	x	Language	dE	50
UNIT	x	Temperature unit	°C	50
RESE	x	Reset - back to factory settings		50
#####		Version number		

### Legend:

Symbol	Description
x	Channel is available
x*	Channel is available, if the corresponding option is activated.

## Arrangement 8: Solar system with afterheating by solid fuel boiler

The controller calculates the temperature difference between collector sensor S1 and store sensor S2. If the difference is larger than or identical to the adjusted switch-on temperature difference (DT O), the solar pump will be activated by relay 1, and the store will be loaded until the switch-off temperature difference (DTF) or the maximum store temperature (S MX) is reached.

A solid fuel boiler will be controlled by relay 2, if the temperature difference between sensors S4 and S3 is larger than or identical to the adjusted switch-on temperature difference (DT3O), until the adjusted minimum (MN3O) and maximum (MX3O) temperature thresholds of the solid fuel boiler and the store are reached. S3 can optionally be used as the reference sensor for the store emergency shut-down option (OSEM).

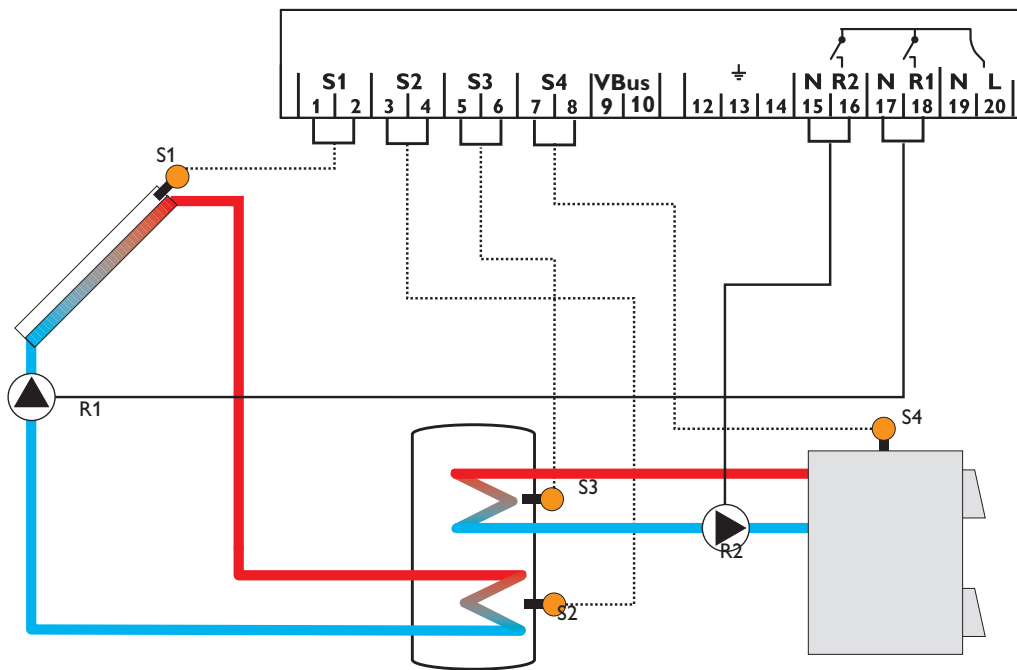
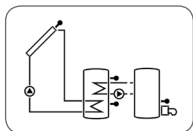

Display channels			
Channel	Description	Connection terminal	Page
INIT	x* ODB initialisation active	-	38
FLL	x* ODB filling time active	-	38
STAB	x* ODB stabilisation in progress	-	38
COL	x Temperature collector	S1	38
TSTB	x Temperature store 1 base	S2	38
TSTT	x Temperature store 1 top	S3	38
TSFB	x Temperature solid fuel boiler	S4	38
n1 %	x Speed R1	R1	39
n2 %	x Speed R2	R2	39
h P1	x Operating hours R1	R1	39
h P2	x Operating hours R2	R2	39
TIME	x Time	-	40

Adjustment channels			
Channel	Description	Factory setting	Page
Arr	x System	8	41
DT O	x Switch-on temperature difference	6.0 K [12.0 °Ra]	41
DT F	x Switch-off temperature difference	4.0 K [8.0 °Ra]	41
DT S	x Set temperature difference	10.0 K [20.0 °Ra]	42
RIS	x Rise R1	2 K [4 °Ra]	42
n1MN	x Minimum speed R1	30 %	42
S MX	x Maximum store temperature	60 °C [140 °F]	42
OSEM	x Store emergency shutdown option	OFF	43
n2MN	s Minimum speed R2	30 %	42
EM	Collector emergency temperature	130 °C [270 °F]	43
	x Collector emergency temperature (if OBST is activated):	95 °C [200 °F]	43
OCC	x Collector cooling option	OFF	43
CMX	x* Maximum collector temperature	110 °C [230 °F]	43
OSYC	x System cooling option	OFF	44
DTCO	x* Switch-on temperature difference cooling	20.0 K [40.0 °Ra]	44
DTCF	x* Switch-off temperature difference cooling	15.0 K [30.0 °Ra]	44
OSTC	x Store cooling option	OFF	44
OHOL	x* Holiday cooling option	OFF	44
THOL	x* Holiday cooling temperature	40 °C [110 °F]	44
OCN	x Collector minimum limitation option	OFF	45
CMN	x* Collector minimum temperature	10 °C [50 °F]	45
OCF	x Antifreeze option	OFF	45

Adjustment channels			
Channel	Description	Factory setting	Page
CFR	x* Antifreeze temperature	4.0 °C [40.0 °F]	45
OTC	x Tube collector option	OFF	47
TCST	x* OTC starting time	07:00	47
TCEN	x* OTC ending time	19:00	47
TCRU	x* OTC runtime	30 s	47
TCIN	x* OTC standstill interval	30 min	47
DT3O	s Switch-on temperature difference 3	6.0 K [12.0 °Ra]	41
DT3F	s Switch-off temperature difference 3	4.0 K [8.0 °Ra]	41
DT3S	s Set temperature difference 3	10.0 K [20.0 °Ra]	42
RIS3	s Rise R2	2 K [4 °Ra]	42
MX3O	s Switch-on threshold for maximum temperature	60.0 °C [140.0 °F]	29
MX3F	s Switch-off threshold for maximum temperature	58.0 °C [136.0 °F]	29
MN3O	s Switch-on threshold for minimum temperature	60.0 °C [140.0 °F]	29
MN3F	s Switch-off threshold for minimum temperature	65.0 °C [150.0 °F]	29
ODB	x Drainback option	OFF	48
tDTO	x* ODB switch-on condition - time period	60 s	48
tFLL	x* ODB filling time	5.0 min	49
tSTB	x* ODB stabilisation time	2.0 min	49
MAN1	x Manual mode R1	Auto	49
MAN2	x Manual mode R2	Auto	49
ADA1	x HE pump control	OFF	49
ADA2	x HE pump control	OFF	49
LANG	x Language	dE	50
UNIT	x Temperature unit	°C	50
RESE	x Reset - back to factory settings		50
#####	Version number		

#### Legend:

Symbol	Description
x	Channel is available
x*	Channel is available, if the corresponding option is activated.

## System-specific functions

The following adjustments are used for the specific functions in system 8.

### $\Delta T$ control for the afterheating by a solid fuel boiler/biomass boiler



#### DT30

Switch-on temperature difference

Adjustment range:

1.0 ... 20.0 K [2.0 ... 40.0 °Ra]

Factory setting: 6.0 K [12.0 °Ra]



#### DT3F

Switch-off temperature difference

Adjustment range:

0.5 ... 19.5 K [1.0 ... 39.0 °Ra]

Factory setting: 4.0 K [8.0 °Ra]

### S4 and S3 are used as the reference sensors for this function.

In system 8 the controller is equipped with an additional differential control for heat exchange from a solid fuel boiler (e. g. pellet stove). The basic differential function is adjusted using the switch-on (**DT30**) and switch-off (**DT3F**) temperature differences.

When the temperature difference exceeds the adjusted switch-on temperature difference, relay 2 switches on. When the temperature difference falls below the adjusted switch-off temperature difference, relay 2 switches off.



#### Note

The switch-on temperature difference must be at least 0.5 K [1 °Ra] higher than the switch-off temperature difference.

### Speed control



#### DT3S

Set temperature difference

Adjustment range:

1.5 ... 30.0 K [3.0 ... 60.0 °Ra]

Factory setting: 10.0 K [20.0 °Ra]

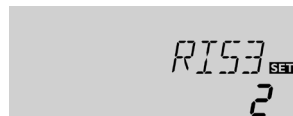

#### RIS3

Rise

Adjustment range: 1 ... 20 K [2 ... 40 °Ra]

Factory setting: 2 K [4 °Ra]

If the temperature difference reaches or exceeds the switch-on temperature difference, the pump switches on at 100% speed for 10 s. Then, the speed is reduced to the minimum pump speed value.

If the temperature difference reaches the adjusted nominal value, the pump speed increases by one step (10%). The response of the controller can be adapted via the parameter Rise. Each time the difference increases by the adjustable rise value, the pump speed increases by 10% until the maximum pump speed of 100% is reached. If the temperature difference decreases by the adjustable rise value, pump speed will be decreased by one step.



#### Note

For pump speed control of the heat exchange pump, the operating mode of relay 2 must be set to **Auto** in the adjustment channel **MAN2**.



#### Note

The set temperature difference must be at least 0.5 K [1 °Ra] higher than the switch-on temperature difference.

## Minimum speed

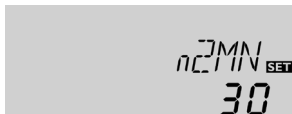

### n2MN

Minimum speed

Adjustment range: 30 ... 100%

Factory setting: 30%

In the adjustment channel **n2MIN** a relative minimum speed for a pump connected can be allocated to the output R2.



### Note

When loads which are not speed-controlled (e. g. valves) are used, the value **n2MN** must be set to 100% to deactivate pump speed control.

## Maximum temperature limitation

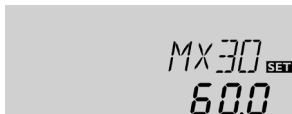

### MX3O

Maximum temperature limitation

Adjustment range: 0.0 ... 95.0 °C [30.0 ... 200.0 °F]

Factory setting:

MX3O: 60.0 °C [140.0 °F]

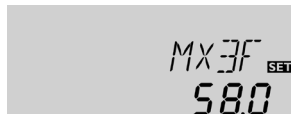

### MX3F

MX3F: 58.0 °C [136.0 °F]

Minimum and maximum temperature limits can be set for the solid fuel boiler.

**S3 is used as the reference sensor for the maximum temperature limitation.**

The maximum temperature limitation function provides a maximum temperature setting, usually to reduce scald risk in a store. If **MX3O** is exceeded, relay 2 is switched off until the temperature at sensor 3 falls below **MX3F**.

## Minimum temperature limitation



### MN3O

Minimum temperature limitation

Adjustment range: 0.0 ... 90.0 °C [30.0 ... 190.0 °F]

Factory setting: (only if Arr = 8):

MN3O: 60.0 °C [140.0 °F]



### MN3F

MN3F: 65.0 °C [150.0 °F]

**S4 is used as the reference sensor for the minimum temperature limitation.**

The minimum temperature limitation function provides a minimum temperature setting for the solid fuel boiler in system 8. If the temperature at sensor 4 falls below **MN3O**, relay 2 is switched off until the temperature at sensor 4 exceeds **MN3F**.

Both switch-on and switch-off temperature differences **DT3O** and **DT3F** are valid for the maximum and minimum temperature limitation.

## Arrangement 9: Solar system with heating-circuit return preheating

The controller calculates the temperature difference between collector sensor S1 and store sensor S2. If the difference is larger than or identical to the adjusted switch-on temperature difference (DT O), the solar pump will be activated by relay 1, and the store will be loaded until the switch-off temperature difference (DT F) or the maximum store temperature (S MX) is reached.

Heating-circuit return preheating will be activated by relay 2, if the temperature difference between sensors S3 and S4 is larger or identical to the adjusted switch-on temperature difference (DT3O). For this purpose, relay 2 controls the 3-port valve. S3 can optionally be used as the reference sensor for the store emergency shut-down option (OSEM).

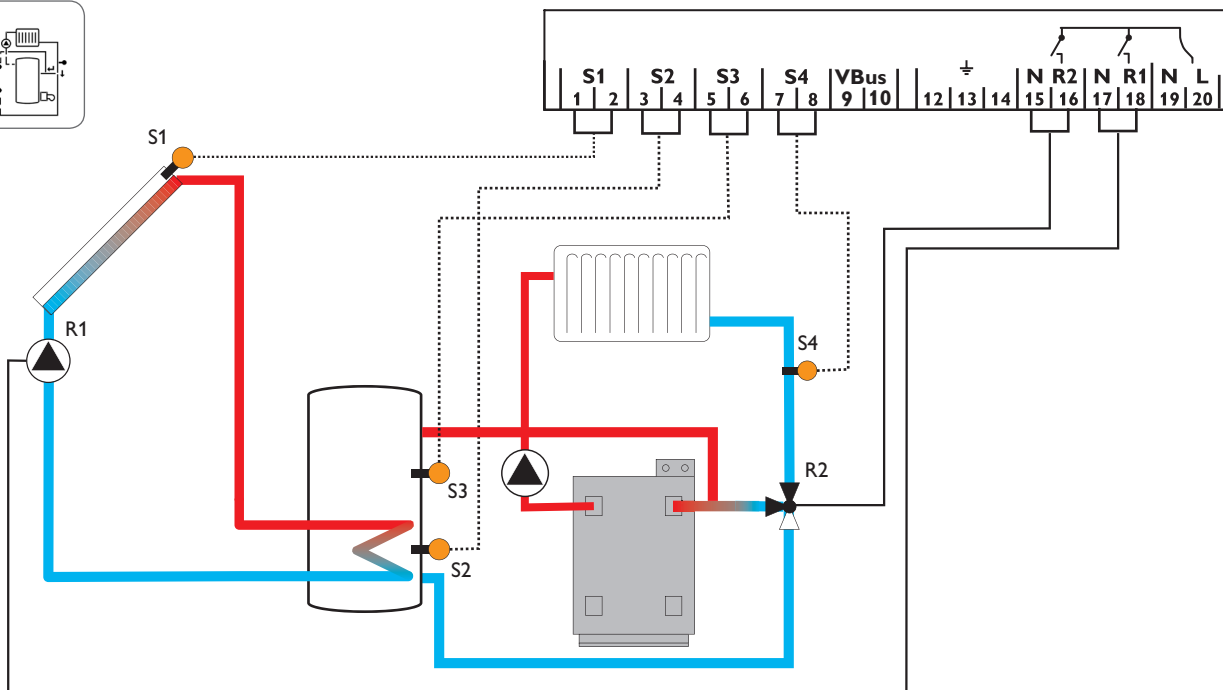
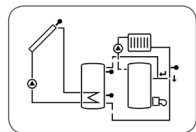

Display channels			
Channel	Description	Connection terminal	Page
INIT	x* ODB initialisation active	-	38
FLL	x* ODB filling time active	-	38
STAB	x* ODB stabilisation in progress	-	38
COL	x Temperature collector	S1	38
TSTB	x Temperature store 1 base	S2	38
TSTT	x Temperature store 1 top	S3	38
TRET	x Heating circuit temperature	S4	38
n %	x Speed relay	R1	39
hP1	x Operating hours R1	R1	39
hP2	x Operating hours R2	R2	39
TIME	x Time	-	40

Adjustment channels			
Channel	Description	Factory setting	Page
Arr	x System	9	41
DT O	x Switch-on temperature difference	6.0K [12.0 °Ra]	41
DT F	x Switch-off temperature difference	4.0K [8.0 °Ra]	41
DT S	x Set temperature difference	10.0K [20.0 °Ra]	42
RIS	x Rise R1	2K [4 °Ra]	42
nMN	x Minimum speed	30%	42
S MX	x Maximum store temperature	60 °C [140 °F]	42
OSEM	x Store emergency shutdown option	OFF	43
	Collector emergency temperature	130 °C [270 °F]	43
EM	x Collector emergency temperature, if OBST is activated:	95 °C [200 °F]	43
OCC	x Collector cooling option	OFF	43
CMX	x* Maximum collector temperature	110 °C [230 °F]	43
OSYC	x System cooling option	OFF	44
DTCO	x* Switch-on temperature difference cooling	20.0K [40.0 °Ra]	44
DTCF	x* Switch-off temperature difference cooling	15.0K [30.0 °Ra]	44
OSTC	x Store cooling option	OFF	44
OHOL	x* Holiday cooling option	OFF	44
THOL	x* Holiday cooling temperature	40 °C [110 °F]	44
OCN	x Collector minimum limitation option	OFF	45
CMN	x* Collector minimum temperature	10 °C [50 °F]	45
OCF	x Antifreeze option	OFF	45
CFR	x* Antifreeze temperature	4.0 °C [40.0 °F]	45
OTC	x Tube collector option	OFF	47

Adjustment channels			
Channel	Description	Factory setting	Page
TCST	x* OTC starting time	07:00	47
TCEN	x* OTC ending time	19:00	47
TCRU	x* OTC runtime	30 s	47
TCIN	x* OTC standstill interval	30 min	47
DT3O	s Switch-on temperature difference 3	6.0K [12.0 °Ra]	41
DT3F	s Switch-off temperature difference 3	4.0K [8.0 °Ra]	41
ODB	x Drainback option	OFF	48
tDTO	x* ODB switch-on condition - time period	60 s	48
tFLL	x* ODB filling time	5.0 min	49
tSTB	x* ODB stabilisation time	2.0 min	49
MAN1	x Manual mode R1	Auto	49
MAN2	x Manual mode R2	Auto	49
ADA1	x HE pump control	OFF	49
LANG	x Language	dE	50
UNIT	x Temperature unit	°C	50
RESE	x Reset - back to factory settings		50

##### Version number

### Legend:

Symbol	Description
x	Channel is available
x*	Channel is available, if the corresponding option is activated.
s*	System-specific channel, only available if the corresponding option is activated

## Arrangement 10: Standard solar system with heat dump

The controller calculates the temperature difference between collector sensor S1 and store sensor S2. If the difference is larger than or identical to the adjusted switch-on temperature difference (DT O), the solar pump will be activated by relay 1, and the store will be loaded until the switch-off temperature difference (DT F) or the maximum store temperature (S MX) is reached.

If the collector maximum temperature (C MAX) is reached, the solar pump will be activated by R1 and the 3-port valve by R2 in order to divert excess heat to a heat sink. For safety reasons, excess heat dump will only take place as long as the store temperature is below the non-adjustable shutdown temperature of 95 °C [200 °F].

Sensors S3 and S4 can optionally be connected for measurement purposes. S3 can optionally be used as the reference sensor for the store emergency shutdown option (OSEM).

If heat quantity measurement (OHQM) is activated, S4 is to be used as the return sensor.

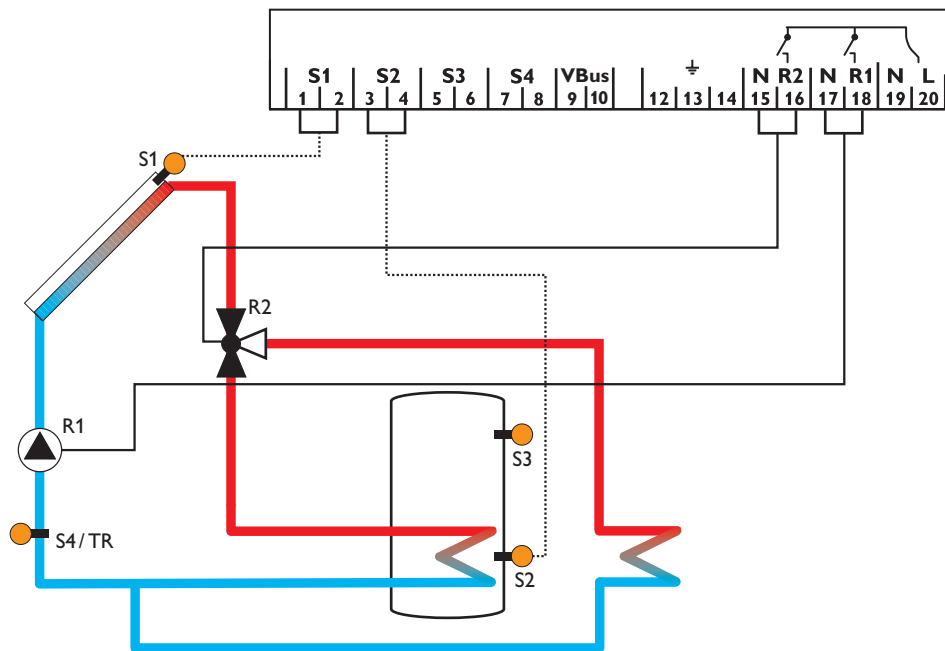
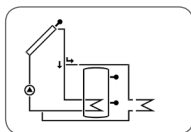



### Display channels

Channel	Description	Connection terminal	Page
COL	x Temperature collector	S1	38
TST	x Temperature store	S2	38
S3	x Temperature sensor 3	S3	39
TSTT	x* Temperature store top	S3	38
S4	x Temperature sensor 4	S4	39
TR	x* Temperature return sensor	S4	39
n %	x Speed relay	R1	39
h P1	x Operating hours R1	R1	40
h P2	x Operating hours R2	R2	40
kWh	x* Heat quantity in kWh	-	39
MWh	x* Heat quantity in MWh	-	39
TIME	x Time	-	40

### Adjustment channels

Channel	Description	Factory setting	Page
Arr	x System	10	41
DT O	x Switch-on temperature difference	6.0K [12.0 °Ra]	41
DT F	x Switch-off temperature difference	4.0K [8.0 °Ra]	41
DT S	x Set temperature difference	10.0K [20.0 °Ra]	42
RIS	x Rise R1	2K [4 °Ra]	42
nMN	x Minimum speed	30%	42
S MX	x Maximum store temperature	60 °C [140 °F]	42
OSEM	x Store emergency shutdown option	OFF	43
EM	x Collector emergency temperature	130 °C [270 °F]	43
CMX	s Maximum collector temperature	110 °C [230 °F]	43
OCN	x Collector minimum limitation option	OFF	45
CMN	x* Collector minimum temperature	10 °C [50 °F]	45
OCF	x Antifreeze option	OFF	45
CFR	x* Antifreeze temperature	4.0 °C [40.0 °F]	45
OTC	x Tube collector option	OFF	47
TCST	x* OTC starting time	07:00	47
TCEN	x* OTC ending time	19:00	47
TCRU	x* OTC runtime	30 s	47
TCIN	x* OTC standstill interval	30 min	47
OHQM	x Heat quantity measurement option	OFF	47
FMAX	x* Maximum flow rate	6.0 l	47
MEDT	x* Heat transfer fluid/Antifreeze type	1	48
MED%	x* Antifreeze concentration (only if MEDT = propylene or ethylene glycol)	45%	48
MAN1	x Manual mode R1	Auto	49
MAN2	x Manual mode R2	Auto	49
ADA1	x HE pump control	OFF	49
LANG	x Language	dE	50
UNIT	x Temperature unit	°C	50
RESE	x Reset - back to factory settings		50
#####	Version number		

### Legend:

Symbol	Description
x	Channel is available
x*	Channel is available, if the corresponding option is activated.
s*	System-specific channel, only available if the corresponding option is activated

## 3 Operation and function

### 3.1 Buttons

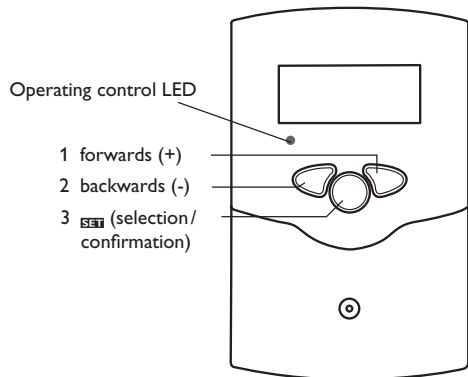

The controller is operated via the 3 push buttons below the display.

**Button 1 (+):** Scrolling forwards, increasing adjustment values

**Button 2 (-):** Scrolling backwards, reducing adjustment values

**Button 3 (OK/SET):** confirming/selecting

During normal operation, display channels will be displayed.

➔ In order to scroll between display channels, press buttons 1 and 2.

#### Access to adjustment channels

➔ Use button 1 in order to scroll to the last display channel, then press and hold down button 1 for approx. 2 s.

If an **adjustment channel** is shown on the screen, **SET** will be displayed on the right-hand side next to the channel name.

➔ Press button 3 in order to select an adjustment channel.

**SET** starts flashing.

➔ Adjust the desired value with buttons 1 and 2.

➔ Briefly press button 3.

**SET** permanently appears, the adjusted value has been saved.

## 4 System-Monitoring-Display

### System-Monitoring-Display

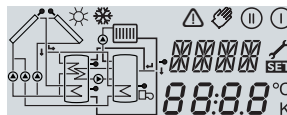

The System-Monitoring-Display consists of 3 blocks: **channel display**, **tool bar** and **system screen**.

#### Channel display

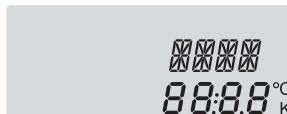

The **channel display** consists of 2 lines. The upper display line is an alphanumeric 16-segment display. In this line, mainly channel names and menu items are displayed. In the lower 16-segment display, values are displayed.

#### Tool bar

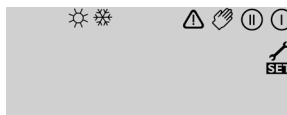

The additional symbols in the **tool bar** indicate the current system state.

## 4.1 System screen

The system selected is indicated in the System-Monitoring-Display. It consists of several system component symbols which are – depending on the current status of the system – either flashing, permanently shown or not indicated.

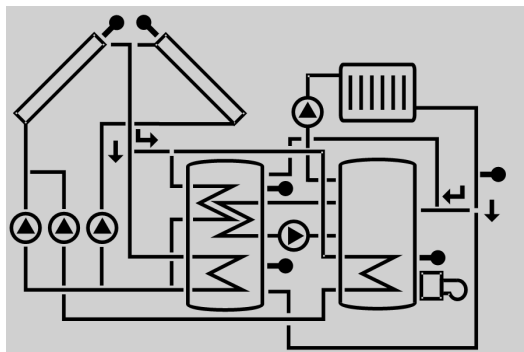

**Collector**  
with collector sensor

 **Temperature sensor**

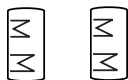

**Stores 1 and 2**  
with heat exchangers

 **Heating circuit**

 **Pump**



**3-port valve**  
Only the flow direction or  
current switching position is  
indicated.

 **Afterheating**  
with burner symbol

## 4.2 Other indications

### System screen

- Pumps are flashing when the corresponding relay is switched on.
- Sensor symbols are flashing, if the corresponding sensor display channel is selected.
- Sensors are flashing quickly in the case of a sensor fault.
- Burner symbol is flashing if the afterheating is active.

### Operating control LED

Green: Everything OK  
 Red / green flashing: Initialisation active  
 Red flashing: Manual mode  
 Sensor fault (sensor symbol is flashing quickly)

Permanently shown	Flashing	Status indications:
ⓘ		Relay 1 on
Ⓜ		Relay 2 on
✱		Maximum store temperature exceeded
	⚠ + ✱	Store emergency shutdown active
	⚠	Collector emergency shutdown active
ⓘ	✱	Collector cooling active
ⓘ	✱	System cooling active
ⓘ + ✱		Store cooling active
✱	⚠	Holiday cooling option activated
ⓘ + ✱	⚠	Holiday cooling option active
	✱	Collector minimum limitation active
✱		Antifreeze function activated
ⓘ / Ⓜ	✱	Antifreeze function active
👤 + ⓘ	⚠	Manual mode relay 1 ON
👤 + Ⓜ	⚠	Manual mode relay 2 ON
👤	⚠	Manual mode relay 1/2 OFF
🔧	⚠	Sensor fault

## 5 Commissioning

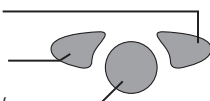
- 1 forwards (+)
  - 2 backwards (-)
  - 3 **SET** (selection / confirmation)
- 

→ Connect the device to the mains.

The controller runs an initialisation phase in which the operating control LED flashes red / green.

When the controller is commissioned or when it is reset, it will run a commissioning menu. The commissioning menu leads the user through the most important adjustment channels needed for operating the system.

### Operation

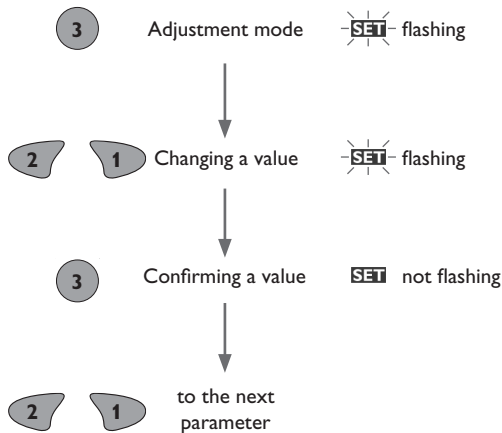

### 1. Language

→ Adjust the desired menu language.

#### LANG

Language selection  
Selection: dE, En, Fr  
Factory setting: dE

### 2. Temperature unit

→ Adjust the desired menu language.

#### UNIT

Temperature unit  
Selection: °F, °C  
Factory setting: °C

### 3. Time

→ Adjust the clock time.

First of all adjust the hours, then the minutes.

#### TIME

Real time clock

### 4. Arrangement

→ Adjust the desired system.

For a detailed description of the systems to choose from, see page 8.

#### Arr

System selection  
Adjustment range: 1 ... 10  
Factory setting: 1

If the system selection is changed later on, any previous adjustments which have been made in the other channels will be lost. Therefore, changing the system is always followed by a security enquiry.

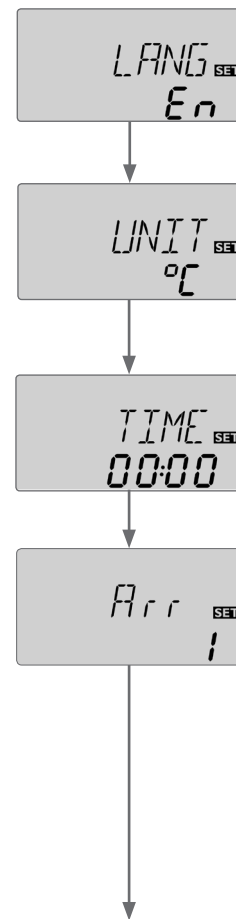

Only confirm the security enquiry if you are sure that you wish to change the system selection.

#### Security enquiry:

→ In order to confirm the security enquiry, press button 3.

#### 5. Maximum store temperature

→ Adjust the maximum store temperature.

##### SMX/S1MX/S2MX

Adjustment range: 4 ... 95 °C [40 ... 200 °F]

Arr 10: 4 ... 90 °C [40 ... 190 °F]

Factory setting: 60 °C [140 °F]



#### Note

The controller is also equipped with a non-adjustable emergency shutdown, deactivating the system if the store reaches 95 °C [200 °F].

#### 6. Minimum speed

→ Adjust the minimum speed for the corresponding pump.

##### nMN, n1MN, n2MN

Speed control

Adjustment range: 30 ... 100%

Factory setting: 30



#### Note

If loads which are not speed-controlled (e. g. valves) are used, the speed must be set to 100%.

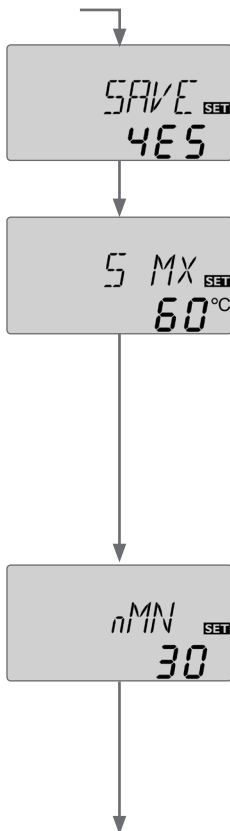

#### Confirmation

##### Completing the commissioning menu

After the last channel of the commissioning menu has been adjusted and confirmed, the controller asks for confirmation of the adjustments.

→ In order to confirm the adjustments made in the commissioning menu, press button 3.

The controller is then ready for operation and normally the factory settings will give close to optimum operation.



#### Note

The adjustments carried out during commissioning can be changed anytime in the corresponding adjustment channel. Additional functions and options can also be activated or deactivated (see page 41).

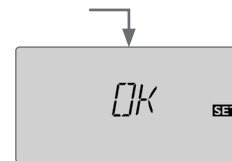

## 6 Channel overview

### 6.1 Display channels



#### Note

The display and adjustment channels as well as the adjustment ranges depend on the system selected, the functions and options as well as on the system components connected to the controller.

#### Display of drainback time periods

##### Initialisation



INIT  
60

##### INIT

ODB initialisation active

Indicates the time adjusted in **tD<sub>TO</sub>**, running backwards.

##### Filling time



FLL  
05:00

##### FLL

ODB filling time active

Indicates the time adjusted in **tFLL**, running backwards.

##### Stabilisation



STAB  
02:00

##### STAB

ODB stabilisation in progress

Indicates the time adjusted in **tSTB**, running backwards.

#### Display of collector temperatures



COL  
185.0

##### COL

Collector temperature

Display range: -40... +260 °C [-40... +500 °F]

Indicates the collector temperature.

- COL : Collector temperature (1-collector system)
- COL2: Collector temperature 2 (2-collector system)

#### Display of store temperatures



TST  
140.0

##### TST, TSTB, TSTT, TST1, TST2, TDIS

Store temperatures

Display range: -40... +260 °C [-40... +500 °F]

Indicates the store temperatures.

- TST : Store temperature (1-store system)
- TSTB : Store temperature base
- TSTT : Store temperature top
- TST1 : Temperature store 1 (2-store system)
- TST2 : Temperature store 2 (2-store system)
- TDIS : Thermal disinfection temperature  
(Arr = 3 only; replaces TSTT if, during thermal disinfection, the heating period DDIS is active)

## Indication of sensors 3 and 4

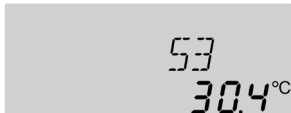

### S3, S4

Sensor temperatures

Display range: -40 ... +260 °C [-40 ... +500 °F]

Indicates the current temperature at the corresponding additional sensor (without control function).

- S3: Temperature at sensor 3
- S4: Temperature at sensor 4



### Note

S3 and S4 will only be indicated if the temperature sensors are connected to the corresponding terminals.

## Display of further temperatures

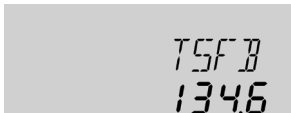

### TFSB, TRET, TR

Other measured temperatures

Display range: -40 ... +260 °C [-40 ... +500 °F]

Indicates the current temperature at the corresponding sensors.

- TFSB : Temperature solid fuel boiler
- TRET : Temperature heating return preheating
- TR : Temperature return

## Indication of current pump speed

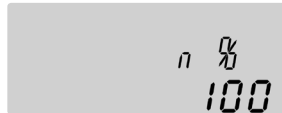

### n %, n1 %, n2 %

Current pump speed

Display range: 30 ... 100 %

Indicates the current pump speed of the corresponding pump.

- n % : Current pump speed (1-pump system)
- n1 % : Current pump speed pump 1
- n2 % : Current pump speed pump 2

## Display of heat quantity



### kWh

Heat quantity in kWh/MWh

Display channel



### MWh

Indicates the heat quantity produced in the system. For this purpose, the heat quantity measurement option has to be enabled. The flow rate as well as the values of the reference sensors flow and return are used for calculating the heat quantity supplied. It is shown in kWh in the **kWh** channel and in MWh in the **MWh** channel. The overall heat quantity results from the sum of both values. The accumulated heat quantity can be set back to zero. As soon as one of the display channels of the heat quantity is selected, the **SET** symbol permanently appears.

→ In order to access the reset mode of the counter, press button 3 for approx. 2 s.

**SET** starts flashing and the heat quantity value will be set back to zero.

→ In order to finish the reset process, press button 3.

In order to interrupt the reset process, do not press any button for about 5 s. The display returns to the display mode.

## Indication of thermal disinfection



### CDIS

Countdown monitoring period

Display range: 0... 30:0... 24 (dd:hh)

If the thermal disinfection option (**OTD**) is activated and the monitoring period is in progress, the remaining time is displayed as **CDIS** (in hours and minutes), counting backwards.

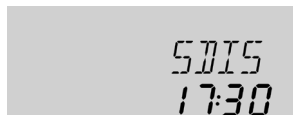

### SDIS

Display of starting time

Display range: 00:00... 24:00 (hh:mm)

If the thermal disinfection option (**OTD**) is activated and a starting delay time has been adjusted, the adjusted starting time is displayed as **SDIS** (flashing).

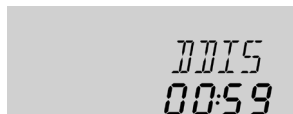

### DDIS

Indication of heating period

Display range: 00:00... 24:00 (hh:mm)

If the thermal disinfection option (**OTD**) is activated and the heating period is in progress, the remaining time is displayed as **CDIS** (in hours and minutes), counting backwards.

## Display of time

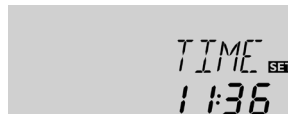

### TIME

Indicates the current clock time.

- ➔ In order to adjust the hours, press button 3 for approx. 2 s.
- ➔ Set the hours by pressing buttons 1 and 2.
- ➔ In order to adjust the minutes, press button 3.
- ➔ Set the minutes by pressing buttons 1 and 2.
- ➔ In order to save the adjustments, press button 3.

## Operating hours counter

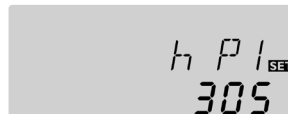

### hP/hP1/hP2

Operating hours counter

Display channel

The operating hours counter accumulates the operating hours of the corresponding relays (**hP/hP1/hP2**). Full hours are displayed.

The accumulated operating hours can be set back to zero. As soon as an operating hours channel is selected, the **SET** symbol permanently appears.

- ➔ In order to access the reset mode of the counter, press button 3 for approx. 2 s. **SET** starts flashing and the operating hours value will be set back to zero.
- ➔ In order to finish the reset process, press button 3.

In order to interrupt the reset process, do not press any button for about 5 s. The display returns to the display mode.



## 6.2 Adjustment channels

Access to adjustment channels

- Use button 1 in order to scroll to the last display channel, then press and hold down button 1 for approx. 2 s.

### System selection



#### Arr

System selection

Adjustment range: 1 ... 10

Factory setting: 1

In this channel, a pre-defined system can be selected. Each system has a set of pre-programmed settings that can be individually changed.

If the system selection is changed later on, any previous adjustments, which have been made in the other channels, will be lost. Therefore, changing the system is always followed by a security enquiry.

**Only confirm the security enquiry if you are sure that you wish to change the system selection.**

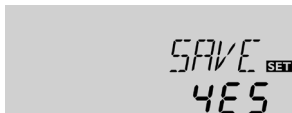

#### Security enquiry:

- In order to confirm the security enquiry, press button 3.

## ΔT control



### DT0/DT10/DT20/DT30

Switch-on temperature difference

Adjustment range: 1.0 ... 20.0 K [2.0 ... 40.0 °Ra]

Factory setting: 6.0 K [12.0 °Ra]

The controller works as a standard differential controller. If the temperature reaches or exceeds the switch-on temperature difference, the pump switches on.

When the temperature difference reaches or falls below the adjusted switch-off temperature difference, the respective relay switches off.



#### Note

The switch-on temperature difference must be at least 0.5 K [1 °Ra] higher than the switch-off temperature difference.



### DTF/DT1F/DT2F/DT3F

Switch-off temperature difference

Adjustment range: 0.5 ... 19.5 K [1.0 ... 39.0 °Ra]

Factory setting: 4.0 K [8.0 °Ra]



#### Note

If the drainback option **ODB** is activated, the values of the parameters **DT0**, **DTF** and **DTS** will be adapted to values suiting drainback systems:

DTE = 10 K [20 °Ra]

DTA = 4 K [8 °Ra]

DTS = 15 K [30 °Ra]

Adjustments that have been previously made in these channels will be overridden and have to be entered again if **ODB** is deactivated later on.

## Speed control

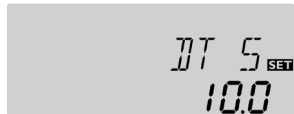

### DT5/DT15/DT25/DT35

Set temperature difference

Adjustment range: 1.5 ... 30.0 K [3.0 ... 60.0 °Ra]

Factory setting: 10.0 K [20.0 °Ra]



#### Note

For pump speed control, the operating mode of the corresponding relay must be set to **Auto** (adjustment channel **MAN1/MAN2**).



### RIS/RIS1/RIS2/RIS3

Rise

Adjustment range: 1 ... 20 K [2 ... 40 °Ra]

Factory setting: 2 K [4 °Ra]

If the temperature difference reaches or exceeds the switch-on temperature difference, the pump switches on at 100% speed for 10 s. Then, the speed is reduced to the minimum pump speed value.

If the temperature difference reaches the adjusted nominal value, the pump speed increases by one step (10%). The response of the controller can be adapted via the parameter Rise. Each time the difference increases by the adjustable rise value, the pump speed increases by 10% until the maximum pump speed of 100% is reached. If the temperature difference decreases by the adjustable rise value, pump speed will be decreased by one step.



#### Note

The set temperature difference must be at least 0.5 K [1 °Ra] higher than the switch-on temperature difference.

## Minimum speed

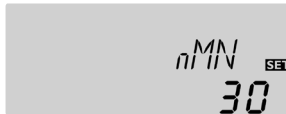

### nMN, n1MN, n2MN

Minimum speed

Adjustment range: 30 ... 100%

Factory setting: 30%

If ODB is activated: 50%

A relative minimum pump speed can be allocated to the outputs R1 and R2 via the adjustment channels **nMN**, **n1MN** and **n2MN**.



#### Note

If loads which are not speed-controlled (e.g. valves) are used, the speed must be set to 100%.

## Maximum store temperature



### SMX/S1MX/S2MX

Maximum store temperature

Adjustment range: 4 ... 95 °C [40 ... 200 °F]

Arr 10: 4 ... 90 °C [40 ... 190 °F]

Factory setting: 60 °C [140 °F]

If the store temperature reaches the adjusted maximum temperature, the store will no longer be loaded in order to avoid damage caused by overheating. A hysteresis of 2 K [4 °Ra] is set for the maximum store temperature.

If the maximum store temperature is exceeded, ✱ is displayed.



#### Note

If the collector cooling or the system cooling function is activated, the adjusted maximum store temperature may be exceeded. In order to prevent system damage, the controller is also equipped with an integrated store emergency shutdown, deactivating the system if the store reaches 95 °C [200 °F].

## Store emergency shutdown

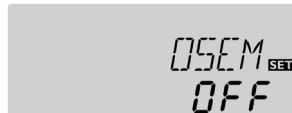

### OSEM

Store emergency shutdown option

Adjustment range: ON, OFF

Factory setting: OFF

This option is used for activating the internal store emergency shutdown for an upper store sensor. If the temperature at the reference sensor exceeds 95 °C [200 °F], store 1 will be blocked and loading will be stopped until the temperature falls below 90 °C [190 °F].



#### Note

Sensor S3 is used as the reference sensor in system 1, 2, 3, 8, 9 and 10. In the system 6 and 7, sensor S4 is used as the reference sensor. This option is not available in systems 4 and 5.

## Collector emergency shutdown/collector limit temperature



### EM/EM1/EM2

Collector emergency temperature

Adjustment range: 80 ... 200 °C [170 ... 390 °F]

Factory setting: 130 °C [270 °F]

When the collector temperature exceeds the adjusted collector limit temperature, the solar pump (R1/R2) switches off in order to protect the system components against overheating (collector emergency shutdown). A hysteresis of 10K [20 °Ra] is set for the collector temperature limitation. If the collector limit temperature is exceeded,  $\Delta$  is displayed.



#### Note

If the drainback option **ODB** is activated, the adjustment range of **EM** is changed to 80 ... 120 °C [170 ... 250 °F]. The factory setting in that case is 95 °C [200 °F].

## Cooling functions

In the following the 3 cooling functions – collector cooling, system cooling and store cooling – are described in detail. The following notes are valid for all 3 cooling functions:



#### Note

The cooling functions will not become active as long as solar loading is possible.



#### Note

In 2-store-systems, the cooling functions will only affect store 1, or the base area of the store respectively (such as in Arr = 4).

## Collector cooling



### OCC/OCC1/OCC2

Collector cooling option

Adjustment range: OFF/ON

Factory setting: OFF



### CMX

Collector maximum temperature

Adjustment range:

70 ... 160 °C [150 ... 320 °F]

Factory setting: 110 °C [230 °F]

The collector cooling function keeps the collector temperature within the operating range by heating the store. If the store temperature reaches 95 °C [200 °F] the function will switch off for safety reasons. If the store temperature exceeds the adjusted maximum store temperature, the solar system is switched off. If the collector temperature increases to the adjusted maximum collector temperature, the solar pump is activated until the collector temperature falls below the maximum collector temperature. The store temperature may then exceed the maximum store temperature, but only up to 95 °C [200 °F] (emergency shutdown of the store).

If the collector cooling function is active,  $\odot$  and  $\otimes$  are displayed (flashing).



#### Note

This function will only be available if the system cooling function (**OSYC**) is deactivated.



#### Note

In system 10, the parameter **CMX** is available without the **OCC** function. In system 10, **CMX** is used for setting the activation temperature for the heat dump function. No other switch-on condition is needed in that case.

## System cooling



OSYC SET  
OFF

### OSYC



System cooling option  
Adjustment range: OFF/ON  
Factory setting: OFF



DTCTF SET  
15.0

### DTCTF

Switch-off temperature difference  
Adjustment range: 0.5 ... 29.5 K [1.0 ... 59.0 °Ra]  
Factory setting: 15.0 K [30.0 °Ra]

The system cooling function aims to keep the solar system operational for a longer time. The function overrides the maximum store temperature to provide thermal relief of the collector field and the heat transfer fluid on hot days. If the store temperature is higher than the adjusted maximum store temperature and the switch-on temperature difference **DTCO** is reached, the solar pump remains switched on or will be switched on. Solar loading is continued until the temperature difference falls below the adjusted value **DTCTF** or the collector limit temperature **EM** is reached. If the system cooling function is active,  and  are displayed (flashing).



### Note

This function will only be available, if the collector cooling function (**OCC**) is deactivated.

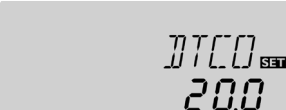

DTCTO SET  
20.0

### DTCTO

Switch-on temperature difference  
Adjustment range:  
1.0 ... 30.0 K [2.0 ... 60.0 °Ra]  
Factory setting: 20.0 K [40.0 °Ra]

## Store cooling



OSTC SET  
OFF

### OSTC

Store cooling option  
Adjustment range: OFF/ON  
Factory setting: OFF

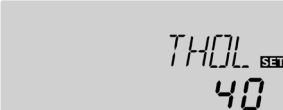

THOL SET  
40

### THOL



Holiday cooling temperature  
Adjustment range: 20 ... 80 °C [70 ... 175 °F]  
Factory setting: 40 °C [110 °F]

When the store cooling function is activated, the controller aims to cool down the store during the night in order to prepare it for solar loading on the following day. If the adjusted maximum store temperature **SMX/S1MX** is exceeded and the collector temperature falls below the store temperature, the system will be reactivated in order to cool down the store.

Cooling will continue until the store temperature has fallen below the adjusted maximum store temperature (**SMX/S1MX**) again. A hysteresis of 2 K [4 °Ra] is set for the store cooling function.

Reference threshold temperature differences for the store cooling function are **DTO** and **DTF**.

If no DHW consumption is expected for a longer period of time, the additional holiday cooling option **OHOL** can be activated in order to extend the store cooling function. The adjustable temperature **THOL** then replaces the maximum store temperature (**SMX/S1MX**) as the switch-off temperature for the store cooling function.

When the holiday cooling function is activated,  and  (flashing) are shown on the display.

If the holiday cooling function is active, ,  and  are displayed (flashing).



OHOL SET  
OFF

### OHOL

Holiday cooling option  
Adjustment range: OFF/ON  
Factory setting: OFF

## Minimum collector limitation

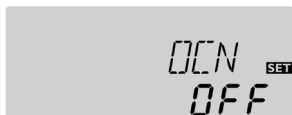

### OCN/OCN1/OCN2

Collector minimum limitation option  
Adjustment range: OFF/ON  
Factory setting: OFF



### CMN

Minimum collector temperature  
Adjustment range:  
10.0 ... 90.0 °C [50.0 ... 190.0 °F]  
Factory setting: 10.0 °C [50.0 °F]

If the collector minimum limitation option is activated, the pump (R1/R2) will only be switched on, if the adjustable collector minimum temperature is exceeded. The minimum temperature prevents the pump from being switched on too often at low collector temperatures. A hysteresis of 5 K [10 °Ra] is set for this function.

If the collector minimum limitation is active, ❄️ is displayed (flashing).



#### Note

If **OSTC** or **OCF** is active, the collector minimum limitation will be overridden. In that case, the collector temperature may fall below **CMN**.

## Antifreeze function

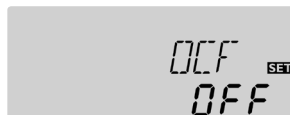

### OCF/OCF1/OCF2

Antifreeze option  
Adjustment range: OFF/ON  
Factory setting: OFF



### CFR/CFR1/CFR2

Antifreeze temperature  
Adjustment range:  
-40.0 ... +10.0 °C [-40.0 ... +50.0 °F]  
Factory setting: +4.0 °C [+40.0 °F]

The antifreeze function activates the loading circuit between the collector and the store when the temperature falls below the adjusted antifreeze temperature. This will protect the fluid against freezing or coagulating. If the adjusted antifreeze temperature is exceeded by 1 K [2 °Ra], the loading circuit will be deactivated.

If the antifreeze function is activated, ❄️ is displayed. If the antifreeze function is active, ⓪ and ❄️ are displayed (flashing).



#### Note

Since this function uses the limited heat quantity of the store, the antifreeze function should only be used in regions with few days of temperatures around the freezing point.

The antifreeze function will be suppressed if the store temperature falls below 5 °C [40 °F] in order to protect the store from frost damage.

## Priority logic



### PRIO

#### Priority

Adjustment range: SE 1, SE 2, Su 1, Su 2, 0, 1, 2

Factory setting: Arr 4: 2; Arr 5, 6: 1

If a 2-store system has been selected, the priority logic determines how the heat is divided between the stores. Different types of priority logic are adjustable:

- SE 1/SE 2: Spreaded loading
- Su 1/Su 2: Successive loading
- 0: Parallel loading
- 1/2: Store sequence control

If priority **PRIO SE 1** or **SE 2** (only available in Arr 6) is adjusted, the subordinate store will be loaded in parallel to the priority store if the temperature difference between the collector and the priority store (store 1 for SE 1, store 2 for SE 2) exceeds the adjusted value **DTSE** and the subordinate store has not reached its maximum temperature.

Parallel loading will stop as soon as the temperature difference between the collector and the priority store falls by 2K [4 °Ra] below **DTSE** or the subordinate store reaches its maximum temperature.

If priority **PRIO Su 1** or **Su 2** is adjusted, the stores are loaded successively. The subordinate store will only be loaded if the priority store (store 1 for Su 1, store 2 for Su 2) has reached its adjusted maximum temperature (**S1MX** or **S2MX**).



#### Note

Priority logic can be used in 2-store system only (Arr = 4, 5, 6).



#### Note

If the priority is set to PRIO Su 1 or Su 2, solar loading of the subordinate store will be stopped at once if the temperature in the priority store (store 1 for Su 1, store 2 for Su 2) falls below the adjusted maximum temperature. If, in that case, the temperature difference between the priority store and the collector is not sufficiently high, solar loading will be stopped completely.

## Spreaded loading temperature difference

(only available if PRIO is set to SE 1 or SE 2)

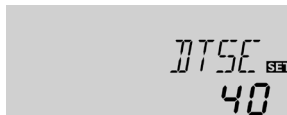

### DTSE

Spread temperature difference

Adjustment range: 20 ... 90K [40 ... 160 °Ra]

in steps of: 1 K [1 °Ra]

Factory setting: 40K [70 °Ra]

If priority **PRIO 0** is adjusted and the switch-on conditions for both stores are fulfilled, the stores are loaded in parallel (Arr 6) or in store sequence control (Arr 4, 5) respectively, beginning with the store with the lowest temperature. In store sequence control, solar loading will switch from one store to the other in steps of 5 K [10 °Ra] temperature difference between the stores.

If **PRIO 1/2** is adjusted, store sequence control will be activated (see below) with the corresponding store as the priority store.

### Store sequence control

(only available if priority is set to PRIO SE 1, SE 2, 1 or 2)

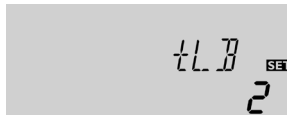

### tLB

Loading break store sequence control

Adjustment range: 1 ... 30 min

Factory setting: 2 min

Store sequence control will be activated when **PRIO** is set to SE 1, SE 2, 1 or 2.

If the priority store cannot be loaded, the subordinate store will be checked. If useful heat can be added to the subordinate store, it will be loaded for the circulation time (**tRUN** – factory setting 15 min). After this, the loading process stops and the controller monitors the increase in collector temperature during the loading break time **tLB**. If it increases by 2K[4 °Ra], the break time starts again to allow the collector to gain more heat. If the collector temperature does not increase sufficiently, the subordinate store will be loaded again for the **tRUN** runtime as before.

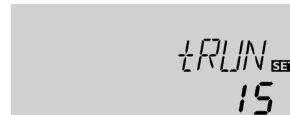

### tRUN

Circulation time store sequence control

Adjustment range: 1 ... 30 min

Factory setting: 15 min

As soon as the switch-on condition of the priority store is fulfilled, it will be loaded. If the switch-on condition of the priority store is not fulfilled, loading of the subordinate store will be continued. If the priority store reaches its maximum temperature, store sequence control will not be carried out.

If store sequence control is active and the system switches to load the priority store, the parameter **tLB** also acts as a stabilisation time, during which the switch-off condition **DTF** is ignored while the system operation is stabilising.

### Tube collector function



#### OTC

Tube collector option

Adjustment range: OFF/ON

Factory setting: OFF



#### TCST

Tube collector function starting time

Adjustment range: 00:00 ... 23:45

Factory setting: 07:00



#### TCRU

Tube collector function runtime

Adjustment range: 5 ... 500 s

Factory setting: 30 s



#### TCEN

Tube collector function ending time

Adjustment range: 00:00 ... 23:45

Factory setting: 19:00



#### TCIN

Tube collector function standstill interval

Adjustment range: 1 ... 60 min

Factory setting: 30 min

This function is used for improving the switch-on behaviour in systems with non-ideal sensor positions (e. g. with some tube collectors). This function operates within an adjusted time frame. It activates the collector circuit pump for an adjustable runtime between adjustable standstill intervals in order to compensate for the delayed temperature measurement. If the runtime is set to more than 10 seconds, the pump will be run at 100% for the first 10 s of the runtime. For the remaining runtime, the pump will be run at the adjusted minimum speed. If the collector sensor is defective or the collector is blocked, this function is suppressed or switched off.

In system 7 (Arr = 7) both collectors are operated independently from each other by means of this function. If the store is being loaded by one collector, the other one is nevertheless operated.



#### Note

If the drainback option **ODB** is activated, **TRCU** will not be available. In that case, the runtime will be determined by the parameters **tFLL** and **tSTB**.

### Heat quantity measurement



#### OHQM

Heat quantity measurement

Adjustment range: OFF/ON

Factory setting: OFF



#### FMAX

Flow rate in l/min

Adjustment range: 0.5 ... 100.0

Factory setting: 6.0



#### MEDT

Heat transfer fluid

Adjustment range: 0 ... 3

Factory setting: 1

#### Heat transfer fluid:

0: Water

1: Propylene glycol

2: Ethylene glycol

3: Tyfocor® LS/G-LS

**MED%**

Antifreeze concentration

in Vol-% (MED% is not indicated when MEDT 0 or 3 is used.)

Adjustment range: 20 ... 70%

Factory setting: 45%

Heat quantity measurement is possible in systems 1, 3, 4, 5 and 10. The heat quantity balancing (estimation) uses the difference between the flow and return temperatures and the entered flow rate (at 100% pump speed).

- ➔ Read the flow rate (l/min) and adjust it in the **FMAX** channel.
- ➔ Adjust the antifreeze type and concentration of the heat transfer fluid in the channels MEDT and MED%.

**Note**

If the system 10 has been selected and **OHQM** is activated, heat quantity measurement will be interrupted when the 3-port valve switches to the heat dump.

**Drainback option**

In a drainback system, the heat transfer fluid will flow into a holding tank if solar loading does not take place. The drainback option initiates the filling process if solar loading is about to start. If the drainback option is activated, the following adjustment can be made.

**Note**

A drainback system requires additional components such as a holding tank. The drainback option should only be activated if all components required are properly installed.

**Note**

The drainback option is only available in system with one store and one collector (Arr 1, 2, 3, 8 and 9).

**ODB**

Drainback option

Adjustment range: OFF/ON

Factory setting: OFF

**Note**

If the drainback option is activated, the cooling functions and the antifreeze function will not be available. If one or more than one of these functions have been activated before, they will be deactivated again as soon as **ODB** is activated. They will remain deactivated, even if **ODB** is deactivated later on.

**Note**

When the drainback option **ODB** is activated, the factory settings of the parameters **nMN/n1MN**, **DTO**, **DTF** and **DTS** will be adapted to values suiting drainback systems:

nMN/n1MN = 50%  
 DTO = 10K  
 DTF = 4K  
 DTS = 15K

Additionally, the adjustment range and the factory setting of the collector emergency shutdown will change. Adjustments previously made in these channels will be overridden and have to be entered again if the drainback option is deactivated later on.

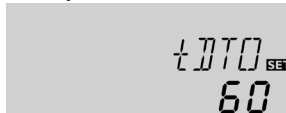
**Time period – switch-on condition****tDTO**

Time period – switch-on condition

Adjustment range: 1 ... 100 s

Factory setting: 60 s

The parameter **tDTO** is used for adjusting the time period during which the switch-on condition must be permanently fulfilled.



## Filling time



### tFLL

Filling time

Adjustment range: 1.0 ... 30.0 min

Factory setting: 5.0 min

The filling time can be adjusted using the parameter **tFLL**. During this period, the pump runs at 100% speed.

## Stabilisation

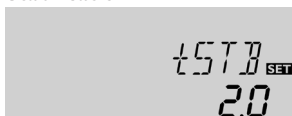

### tSTB

Stabilisation

Adjustment range: 1.0 ... 15.0 min

Factory setting: 2.0 min

The parameter **tSTB** is used for adjusting the time period during which the switch-off condition will be ignored after the filling time has ended.

## Booster function

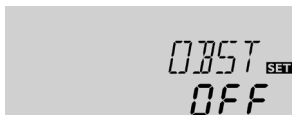

### OBST

Booster function

Adjustment range: ON/OFF

Factory setting: OFF

This function is used for switching on a second pump when filling the solar system. When solar loading starts, R2 is energised in parallel to R1. After the filling time has elapsed, R2 switches off.



### Note

The booster function is available in system 1 only. The booster function will only be available if the drainback option has been activated.

## Manual mode/Operating mode

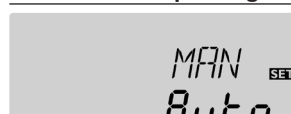

### MAN1/MAN2

Operating mode

Adjustment range: OFF, Auto, ON

Factory setting: Auto

For control and service work, the operating mode of the relays can be manually adjusted. For this purpose, select the adjustment value **MAN1** (for R1) or **MAN2** (for R2) in which the following adjustments can be made:

#### • MAN1/MAN2

Operating mode

OFF : Relay off  $\Delta$  (flashing) +  $\text{☞}$

Auto : Relay in automatic operation

ON : Relay on  $\Delta$  (flashing) +  $\text{☞}$  +  $\text{⓪/Ⓜ}$



### Note

Always adjust the operating mode back to **Auto** when the control and service work is completed. Normal operation is not possible in manual mode.

## HE pump control

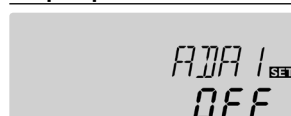

### ADA1/ADA2

HE pump control via adapter (see accessories page 56)

Adjustment range: ON, OFF

Factory setting: OFF

This option is used for controlling high-efficiency pumps via a VBus®/PWM adapter. The power supply of the pump(s) is carried out via the semiconductor relay(s). For pump speed control with activated **ADA1/ADA2** option, the relay is switched on or off (no burst control). Temperature dependent speed information is transmitted via the VBus®. The relay will remain deactivated for 1 hour after its switch-off conditions have been fulfilled (pump protection).

## Language



### LANG

Language selection

Selection: dE, En, Fr

Factory setting: dE

In this adjustment channel the menu language can be selected.

- dE : German
- En : English
- Fr : French

### Unit



### UNIT

Temperature unit selection

Selection: °F, °C

Factory setting: °C

In this adjustment channel, the display unit for temperatures and temperature differences can be selected. The unit can be switched between °C/K and °F/°Ra during operation.

Temperatures and temperature differences in °F and °Ra are displayed without units. If the indication is set to °C, the units are displayed with the values.

## Reset



### RESE

Reset function

By means of the reset function, all adjustments can be set back to their factory settings.

➔ In order to carry out a reset, press button 3

All adjustments that have previously been made will be lost! For this reason, a security enquiry will appear after the reset function has been selected.

**Only confirm the security enquiry if you are sure you want to set back all adjustment to the factory setting.**

### Security enquiry

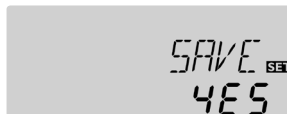

➔ In order to confirm the security enquiry, press button 3.



### Note

After a reset, the commissioning menu will start again (see page36).

## 7 Troubleshooting

### WARNING! Electric shock!



Upon opening the housing, live parts are exposed!  
**→ Always disconnect the device from power supply before opening the housing!**

The controller is protected by a fuse. The fuse holder (which also holds the spare fuse) becomes accessible when the cover is removed. To replace the fuse, pull the fuse holder from the base.

If a malfunction occurs, the display symbols will indicate an error code.

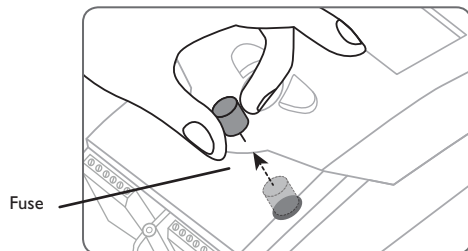

Operating control LED is permanently off.



If the display is off, check the power supply of the controller. Is it disconnected?

no

The fuse of the controller could be blown. The fuse holder (which holds the spare fuse) becomes accessible when the cover is removed. The fuse can then be replaced.

yes

Check the supply line and reconnect it.

The symbol  is indicated on the display and the symbol  flashes.

Sensor fault. An error code instead of a temperature is shown on the sensor display channel.

888.8

- 88.8

Cable is broken. Check the cable.

Short circuit. Check the cable.

Disconnected Pt1000 temperature sensors can be checked with an ohmmeter. Please check the resistance values correspond with the table.

°C	°F	Ω	°C	°F	Ω
-10	14	961	55	131	1213
-5	23	980	60	140	1232
0	32	1000	65	149	1252
5	41	1019	70	158	1271
10	50	1039	75	167	1290
15	59	1058	80	176	1309
20	68	1078	85	185	1328
25	77	1097	90	194	1347
30	86	1117	95	203	1366
35	95	1136	100	212	1385
40	104	1155	105	221	1404
45	113	1175	110	230	1423
50	122	1194	115	239	1442

Resistance values of Pt1000 sensors



### Note

For answers to frequently asked questions (FAQ) see [www.resol.com](http://www.resol.com).

Pump is overheated, but no heat transfer from the collector to the store, flow and return have the same temperature; perhaps also bubbling in the lines.

Air or gas bubbles in the system?

no

yes

Vent the system; increase the system pressure to a static primary pressure of at least plus 0.5 bar [7.25 psi]; if necessary continue to increase the pressure; switch the pump on and off for a short time.

Are the valves or the non-return valves defective or is the dirt trap blocked?

yes

Clean the dirt trap or replace defective component.

Pump starts up very late.

Switch-on temperature difference  $\Delta T_{on}$  too large?

no

yes

Change  $\Delta T_{on}$  and  $\Delta T_{off}$  correspondingly.

Non-ideal position of the collector sensor (e.g. flatscrew sensor instead of sensor in immersion sleeves).

no

yes

Put the solar pump (R1) into the manual mode On for a short time during irradiation. Check whether the collector temperature significantly increases.

Minimum limitation active.

o.k.

Pump starts for a short moment, switches off, switches on again, etc.

Temperature difference at the controller too small?

no

yes

Change  $\Delta T_{on}$  and  $\Delta T_{off}$  correspondingly.

Wrong position of collector sensors?

no

yes

Mount the collector sensor at solar flow (warmest collector output); use immersion sleeve of the respective collector.

Plausibility control of the option tube collector function.

The temperature difference between store and collector increases enormously during operation; the collector circuit cannot dissipate the heat.

Collector circuit pump/zone valve defective?

no

yes

Check or replace, if necessary.

Heat exchanger calcified?

no

yes

Decalcify it.

Heat exchanger blocked?

no

yes

Clean it.

Heat exchanger too small?

yes

Replace with correctly sized one.

Stores cool down at night.

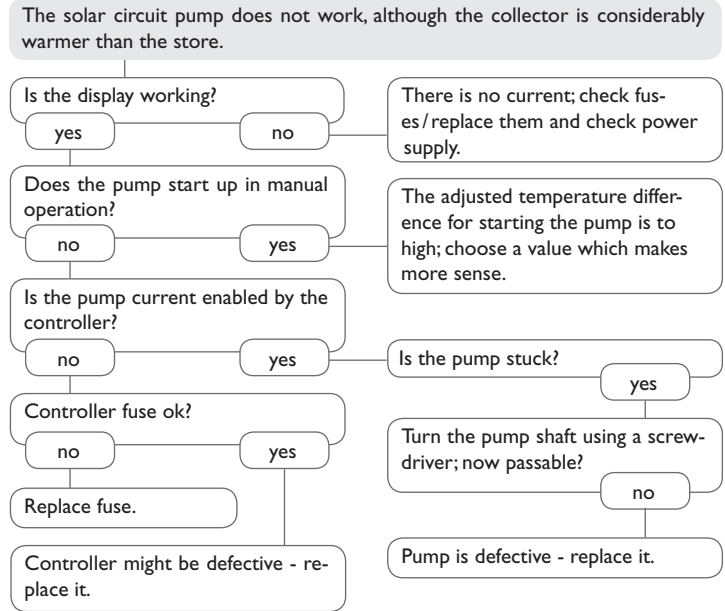
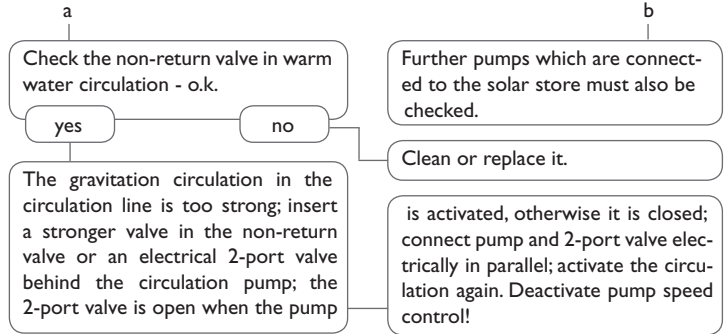
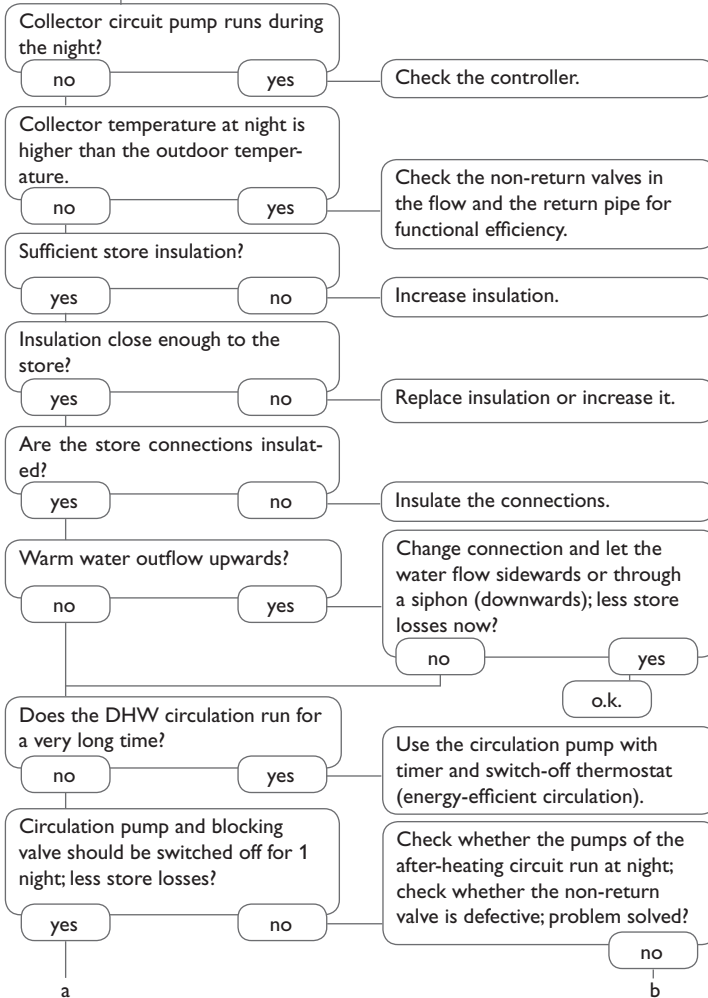

## 8 Accessories



Moisture-proof housing



Sensors



Overvoltage protection device



VBus®/LAN, VBus®/PWM & VBus®/USB interface adapters



SD3 Smart Display/  
GA3 Large Display



AM1 Alarm Module



KM1 Communication  
module



DL2 Datalogger



DL3 Datalogger

## 8.1 Sensors and measuring instruments

### Temperature sensors

The product range includes high-precision platinum temperature sensors, flatscrew sensors, outdoor temperature sensors, indoor temperature sensors, cylindrical clip-on sensors, also as complete sensors with immersion sleeve.

### Overvoltage protection device

In order to avoid overvoltage damage at collector sensors (e. g. caused by local lightning storms), we recommend installing the overvoltage protection RESOL SP10.

## 8.2 VBus® accessories

### SD3 Smart Display

The RESOL Smart Display is designed for simple connection to RESOL controllers with RESOL VBus®. It is used for visualising data issued by the controller: collector temperature, store temperature and energy yield of the solar thermal system. The use of high-efficiency LEDs and filter glass assures a high optical brilliance. An additional power supply is not required.

### GA3 Large display module

The GA3 is a completely mounted large display module for visualisation of collector- and store temperatures as well as the heat quantity yield of the solar system via one 6-digit and two 4-digit 7-segment-displays. An easy connection to all controllers with RESOL VBus® is possible. The front plate is made of antireflective filterglass and is printed with a light-resistant UV-lacquering. The universal RESOL VBus® allows the parallel connection of 8 large displays as well as additional VBus® modules.

### AM1 Alarm Module

The AM1 Alarm Module is designed to signal system failures. It is to be connected to the VBus® of the controller and issues an optical signal via the red LED if a failure has occurred. The AM1 also has a relay output, which can e. g. be connected to a building management system (BMS). Thus, a collective error message can be issued in the case of a system failure.

The AM1 Alarm module ensures that occurring failures can be immediately recognised and repaired, even if the system and the controller are difficult to access or located in a remote place. Thus, the reliability and the stable yield of the system are ensured.

### KM1 Communication module

The KM1 Communication module is the network connection for solar and heating systems, especially suited for technicians managing large systems, heating installers and home owners who like to keep a close eye on their system. The system can be parameterised over the Internet. VBus.net enables e. g. controlling the system yield in a comprehensive system scheme image.

### DL2 Datalogger

This additional module enables the acquisition and storage of large amounts of data (such as measuring and balance values of the solar system) over a long period of time. The DL2 can be configured and read-out with a standard Internet browser via its integrated web interface. For transmission of the data stored in the internal memory of the DL2 to a PC, an SD card can be used. The DL2 is appropriate for all controllers with RESOL VBus®. It can be connected directly to a PC or router for remote access and thus enables comfortable system monitoring for yield monitoring or for diagnostics of faults.

### DL3 Datalogger

Be it solar thermal, heating or DHW heat exchange controllers – with the DL3 you can easily and conveniently log system data of up to 6 RESOL controllers. Get a comprehensive overview of all controllers connected with the large full graphic display. Transfer data with an SD memory card, or use the LAN interface to view and process data on your PC.

### VBus.net

The Internet portal for easy and secure access to your system data. VBus.net is all about the data of your RESOL controller. Live data of your system, customized filter settings and much more await you.

### 8.3 Interface adapters

---

#### **VBus®/LAN interface adapter**

The VBus®/LAN interface adapter is designed for the direct connection of the controller to a PC or router. It enables easy access to the controller via the local network of the owner. Thus, controller access, data charting and system parameterisation can be effected from every workstation of the network. The VBus®/LAN interface adapter is suitable for all controllers equipped with a RESOL VBus®. The RESOL ServiceCenter software is included.

#### **VBus®/PWM interface adapter**

The VBus®/PWM interface adapter enables the speed control of two high-efficiency pumps even without an integrated PWM output on the system controller. The adapter is installed between the VBus® output of the controller and the PWM input of the high-efficiency pump, where it transforms the VBus® data packets into a 0-10 V and/or a PWM signal.

#### **VBus®/USB interface adapter**

The VBus®/USB interface adapter is the interface between the controller and a personal computer. With its standard mini USB port it enables a fast transmission of system data for processing, visualising and archiving as well as the parameterisation of the controller via the VBus®. The RESOL ServiceCenter software is included.

### 8.4 Accessories

---

#### **Moisture-proof housing**

Moisture-proof housing for controller installation outdoors or in highly humid locations.



<b>A</b>	
Accessories.....	54, 55, 56
Afterheating.....	16
Antifreeze function.....	45
<b>B</b>	
Booster function.....	49
<b>C</b>	
Code.....	51
Collector cooling.....	43
Collector emergency shutdown.....	43
Commissioning.....	36
Cooling functions.....	43
<b>D</b>	
$\Delta T$ control.....	41
Data communication/Bus.....	6
Display.....	34
Drainback option.....	48
<b>E</b>	
Electrical connection.....	6
<b>H</b>	
Heat quantity measurement.....	47
HE pump control.....	50
Holiday.....	44
<b>L</b>	
Language.....	50
<b>M</b>	
Manual mode.....	49
Minimum collector limitation.....	45
Minimum temperature.....	45
Mounting.....	5
<b>O</b>	
Operating mode.....	49
<b>S</b>	
Sensors.....	39
Speed control.....	42
Store cooling.....	44
System-Monitoring-Display.....	34
System screen.....	35
<b>T</b>	
Technical data.....	4
Thermal disinfection.....	17
Time.....	36
Troubleshooting.....	51
Tube collector function.....	47
<b>U</b>	
Unit.....	50





Distributed by:

## **RESOL – Elektronische Regelungen GmbH**

Heiskampstraße 10  
45527 Hattingen / Germany

Tel.: +49 (0) 23 24 / 96 48 - 0

Fax: +49 (0) 23 24 / 96 48 - 755

[www.resol.com](http://www.resol.com)

[info@resol.com](mailto:info@resol.com)

### **Important note**

The texts and drawings in this manual are correct to the best of our knowledge. As faults can never be excluded, please note:

Your own calculations and plans, under consideration of the current standards and directions should only be basis for your projects. We do not offer a guarantee for the completeness of the drawings and texts of this manual - they only represent some examples. They can only be used at your own risk. No liability is assumed for incorrect, incomplete or false information and / or the resulting damages.

### **Note**

The design and the specifications can be changed without notice.

The illustrations may differ from the original product.

### **Imprint**

This mounting- and operation manual including all parts is copyrighted. Another use outside the copyright requires the approval of RESOL - Elektronische Regelungen GmbH. This especially applies for copies, translations, micro films and the storage into electronic systems.

© **RESOL – Elektronische Regelungen GmbH**