

8PKIT		8 SOLAR PANELS KIT			Article No./Reference	
Designed by ALESSANDRO_FANTINI	Checked by OLGA_ULANOV	Approved by - date RA-2021/06/01	File name 8X30_DIY	Date 2021/06/07	Scale NTS	
This drawing is the property of AQUA SOLANOR INC. It may not be used for any purpose other than the owner. AQUA SOLANOR INC does not authorize the reproduction or conveyance of any information contained herein without prior written permission.			HYDRONIC_SOLAR_KIT			
			DWG.NO.:30T2C300L		REVISION 0	Sheet K02

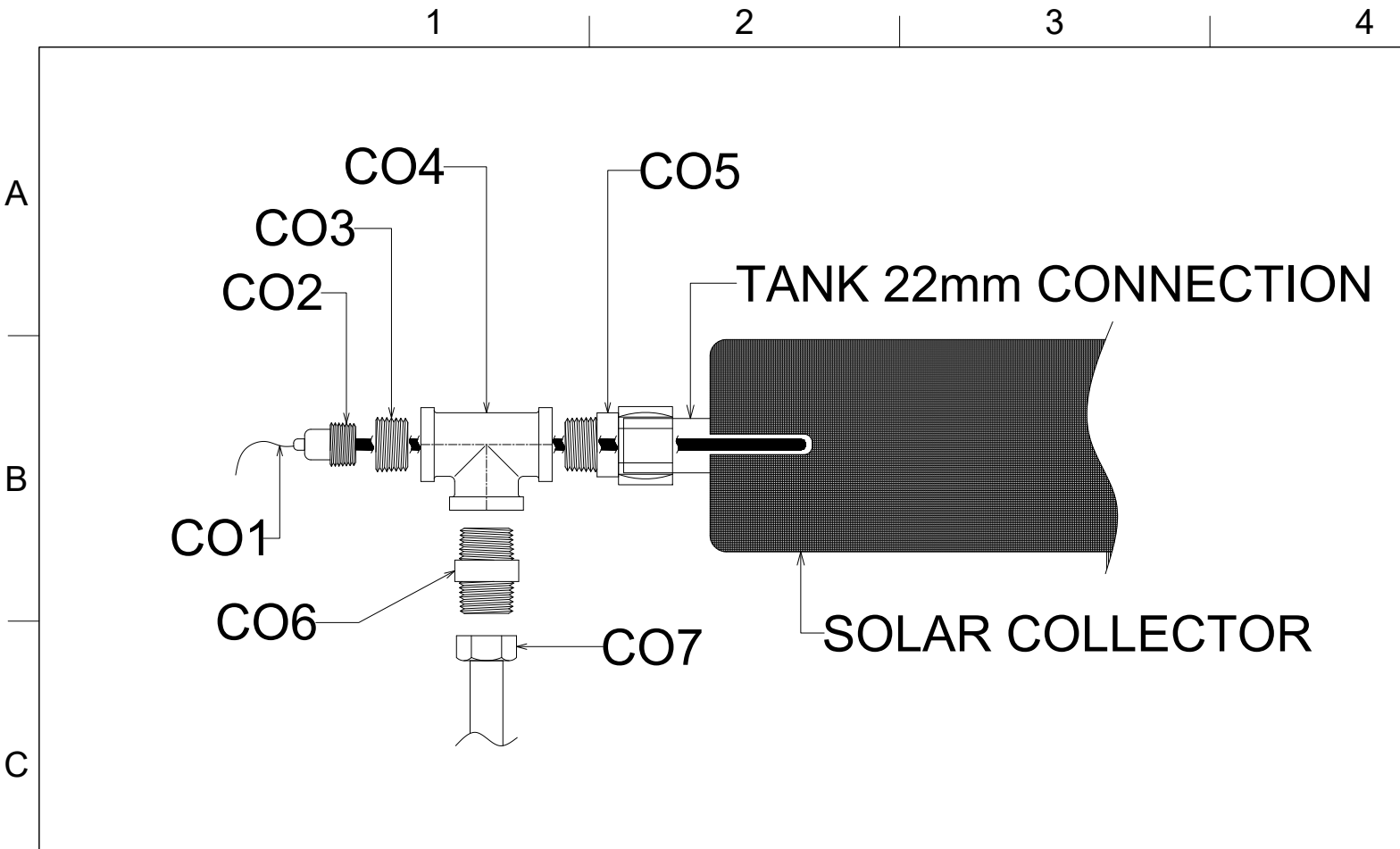

HSSCO50

1/2" COLLECTOR'S OUTLET CONNECTION KIT

CO1	TEMPERATURE SENSOR	
CO2	THERMAL WELL 1/2" MALE	
CO3	NONE	
CO4	FEMALE THREADED TEE 1/2" BSPT	
CO5	PANEL CONNECTOR 1/2" MALE BSPT TO 22mm COMPRESSION	
CO6	BSPT MALE THREADED NIPPLE 1/2 x 1/2"	
CO7	BSPT SOLAR HOSE CONNECTOR 1/2" BSP NUT, SS CLIP & GASKET	

HSSCO75

3/4" COLLECTOR'S OUTLET CONNECTION KIT

CO1	TEMPERATURE SENSOR	
CO2	THERMAL WELL 1/2" MALE	
CO3	REDUCER BUSH 3/4 x 1/2" BSPT	
CO4	FEMALE THREADED TEE 3/4" BSPT	
CO5	PANEL CONNECTOR 3/4" MALE BSPT TO 22mm COMPRESSION	
CO6	BSPT MALE THREADED NIPPLE 3/4 x 3/4"	
CO7	BSPT SOLAR HOSE CONNECTOR 3/4" BSP NUT, SS CLIP & GASKET	

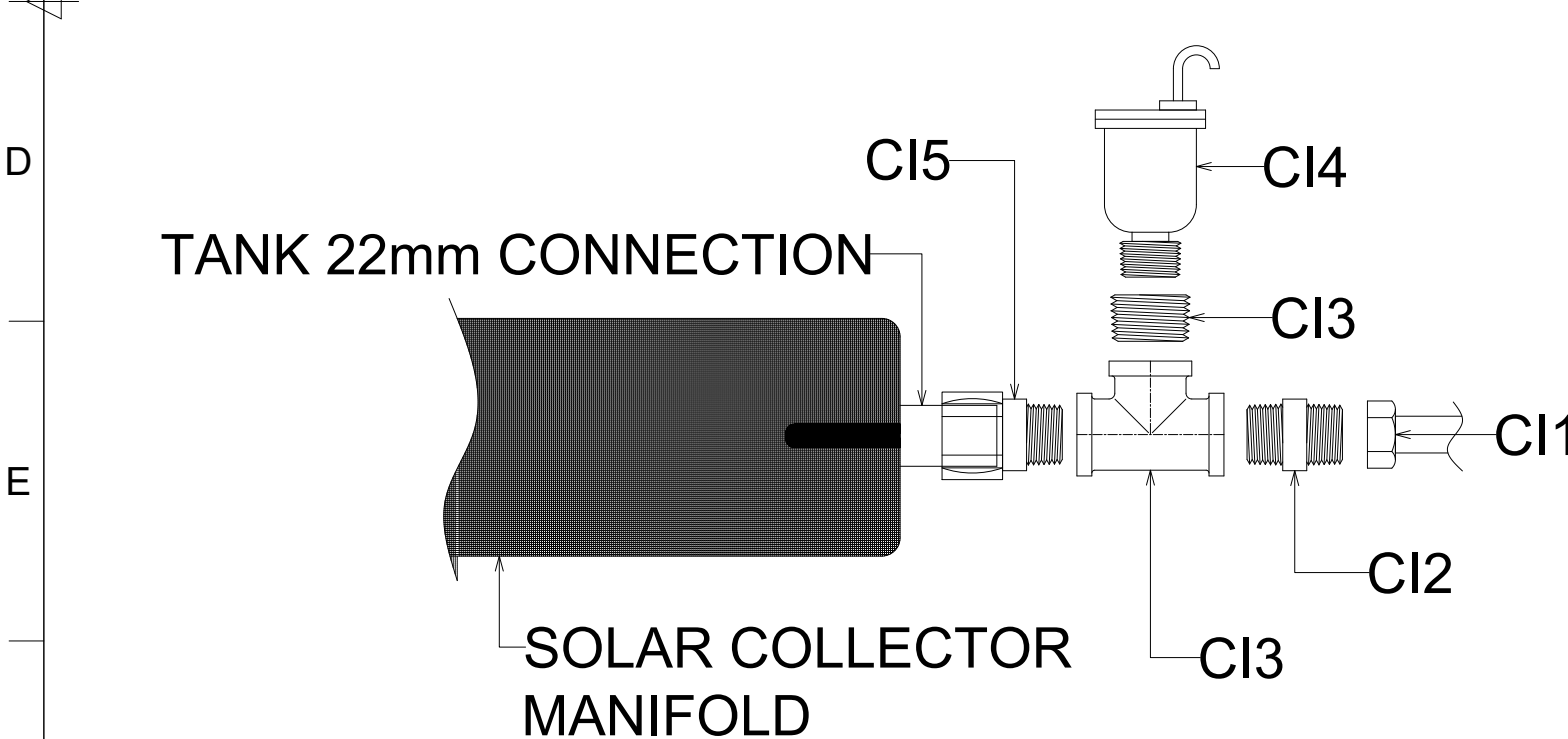

HSSCI50

1/2" COLLECTOR'S INLET CONNECTION KIT

CI3	NONE	
CI4	AUTOMATIC AIR VENT 1/2" MALE BSPT	
CI5	PANEL CONNECTOR 1/2" MALE BSPT TO 22mm COMPRESSION	
CI2	BSPT MALE THREADED NIPPLE 1/2 x 1/2"	
CI1	BSPT SOLAR HOSE CONNECTOR 1/2" BSP NUT, SS CLIP & GASKET	

HSSCI75

3/4" COLLECTOR'S INLET CONNECTION KIT

CI3	REDUCER BUSH 3/4 x 1/2" BSPT	
CI4	FEMALE THREADED TEE 3/4" BSPT	
CI5	PANEL CONNECTOR 3/4" MALE BSPT TO 22mm COMPRESSION	
CI2	BSPT MALE THREADED NIPPLE 3/4 x 3/4"	
CI1	BSPT SOLAR HOSE CONNECTOR 3/4" BSP NUT, SS CLIP & GASKET	

RevNo	Revision note	Date	Signature	Checked
01	FOR SUBMISSION TO CLIENT	2020-09-29	RA	YES

This drawing is the property of AQUA SOLANOR INC. It may not be used for any purpose other than the owner. AQUA SOLANOR INC does not authorize the reproduction or conveyance of any information contained herein without prior written permission.

Ref. #	P/N			SERVICE	
Designed by OLGA	Checked by ROGER	Approved by - date RA_2020-09-30	File name SS1	Date 20200929	Scale NTS
AQUA SOLANOR			SOLAR_HEATING_KIT		
2459 46TH AVENUE, LACHINE (QC) H8T3C9			DWG.NO.:SS215	Revision 0	Sheet DT-01

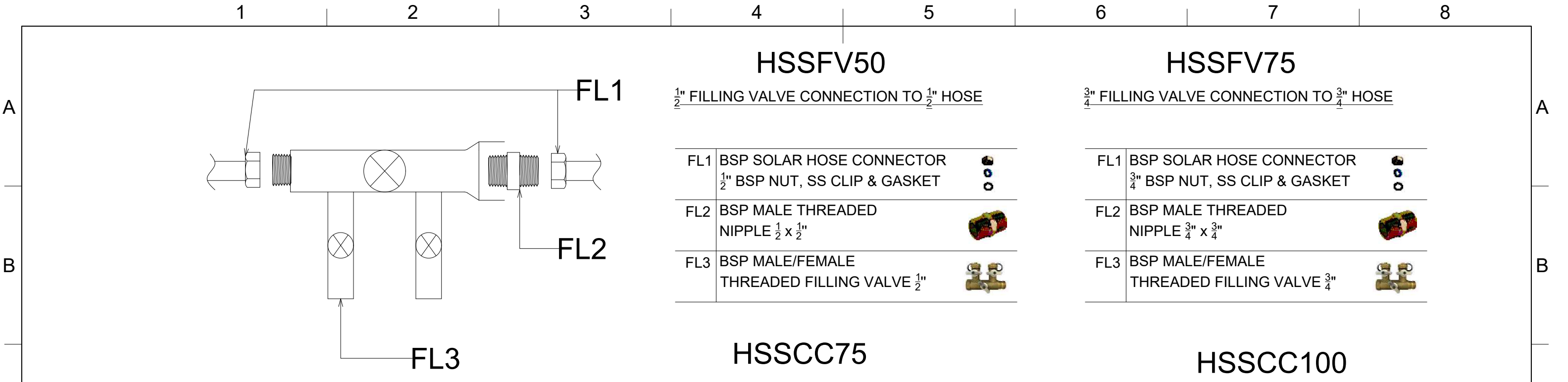

HSSFV50

$\frac{1}{2}$ " FILLING VALVE CONNECTION TO $\frac{1}{2}$ " HOSE

FL1	BSP SOLAR HOSE CONNECTOR $\frac{1}{2}$ " BSP NUT, SS CLIP & GASKET	
FL2	BSP MALE THREADED NIPPLE $\frac{1}{2}$ x $\frac{1}{2}$ "	
FL3	BSP MALE/FEMALE THREADED FILLING VALVE $\frac{1}{2}$ "	

HSSFV75

$\frac{3}{4}$ " FILLING VALVE CONNECTION TO $\frac{3}{4}$ " HOSE

FL1	BSP SOLAR HOSE CONNECTOR $\frac{3}{4}$ " BSP NUT, SS CLIP & GASKET	
FL2	BSP MALE THREADED NIPPLE $\frac{3}{4}$ x $\frac{3}{4}$ "	
FL3	BSP MALE/FEMALE THREADED FILLING VALVE $\frac{3}{4}$ "	

HSSCC75

$\frac{3}{4}$ " TANK CONNECTION KIT TO $\frac{3}{4}$ " FLEXIBLE STAINLESS STEEL SOLAR PIPE

TK1	BSPT SOLAR HOSE CONNECTOR $\frac{3}{4}$ " BSPT NUT, SS CLIP & GASKET	
TK2	NPT/BSPT THREADED ADAPTER FEMALE NPT $\frac{3}{4}$ " x MALE BSP $\frac{3}{4}$ "	

HSSCC100

$\frac{3}{4}$ " TANK COIL CONNECTION KIT TO 1" FLEXIBLE STAINLESS STEEL SOLAR PIPE

TK1	BSPT SOLAR HOSE CONNECTOR 1" BSP NUT, SS CLIP & GASKET	
TK2	NPT/BSPT THREADED ADAPTER FEMAL NPT $\frac{3}{4}$ " x MALE BSP $\frac{3}{4}$ "	
TK3	BSPT REDUCER BUSH 1" x $\frac{3}{4}$ "	

NOT INCLUDED IN THE KIT

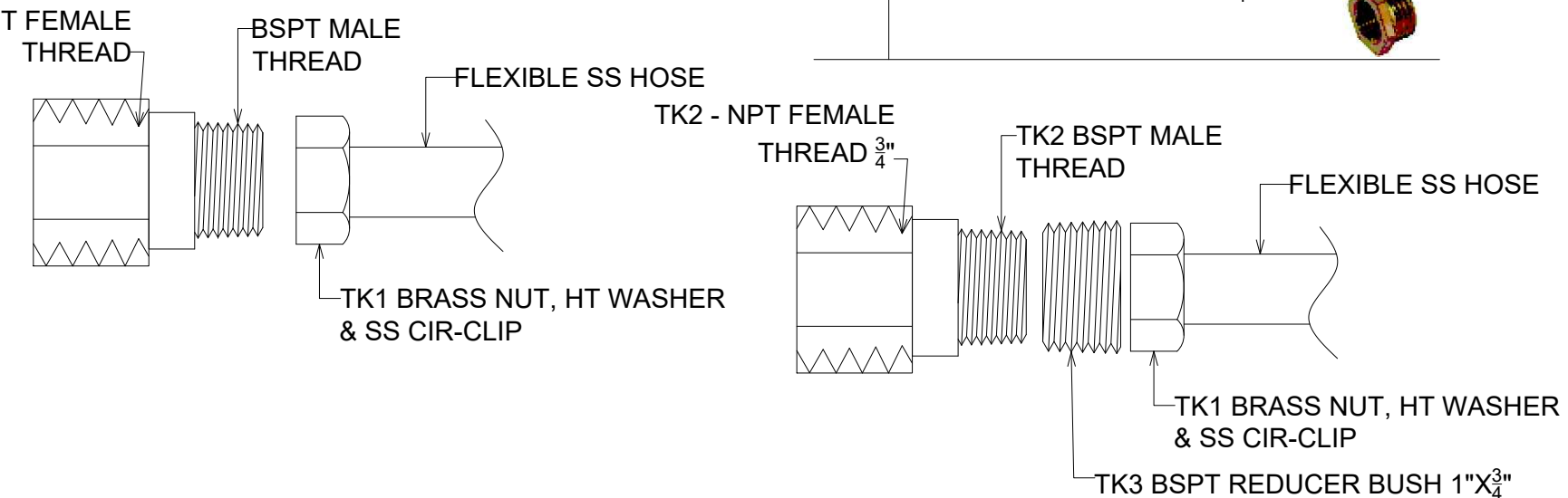
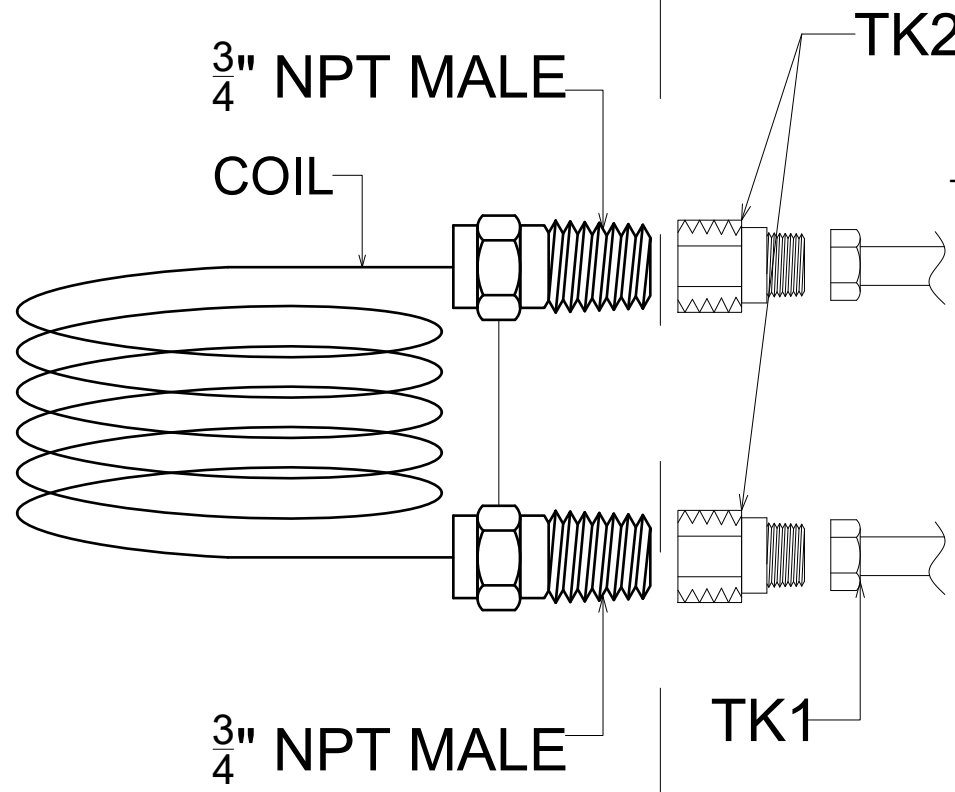

Ref. #	P/N			SERVICE	
Designed by OLGA	Checked by ROGER	Approved by - date RA_2020-09-30	File name SS1	Date 20200929	Scale NTS

This drawing is the property of AQUA SOLANOR INC. It may not be used for any purpose other than the owner. AQUA SOLANOR INC does not authorize the reproduction or conveyance of any information contained herein without written permission.

AQUA SOLANOR
2459 46TH AVENUE, LACHINE (QC) H8T3C9

SOLAR_HEATING_KIT

DWG.NO.:SS215 Revision 0 Sheet DT-02

RevNo	Revision note	Date	Signature	Checked
01	FOR SUBMISSION TO CLIENT	2020-09-29	RA	YES

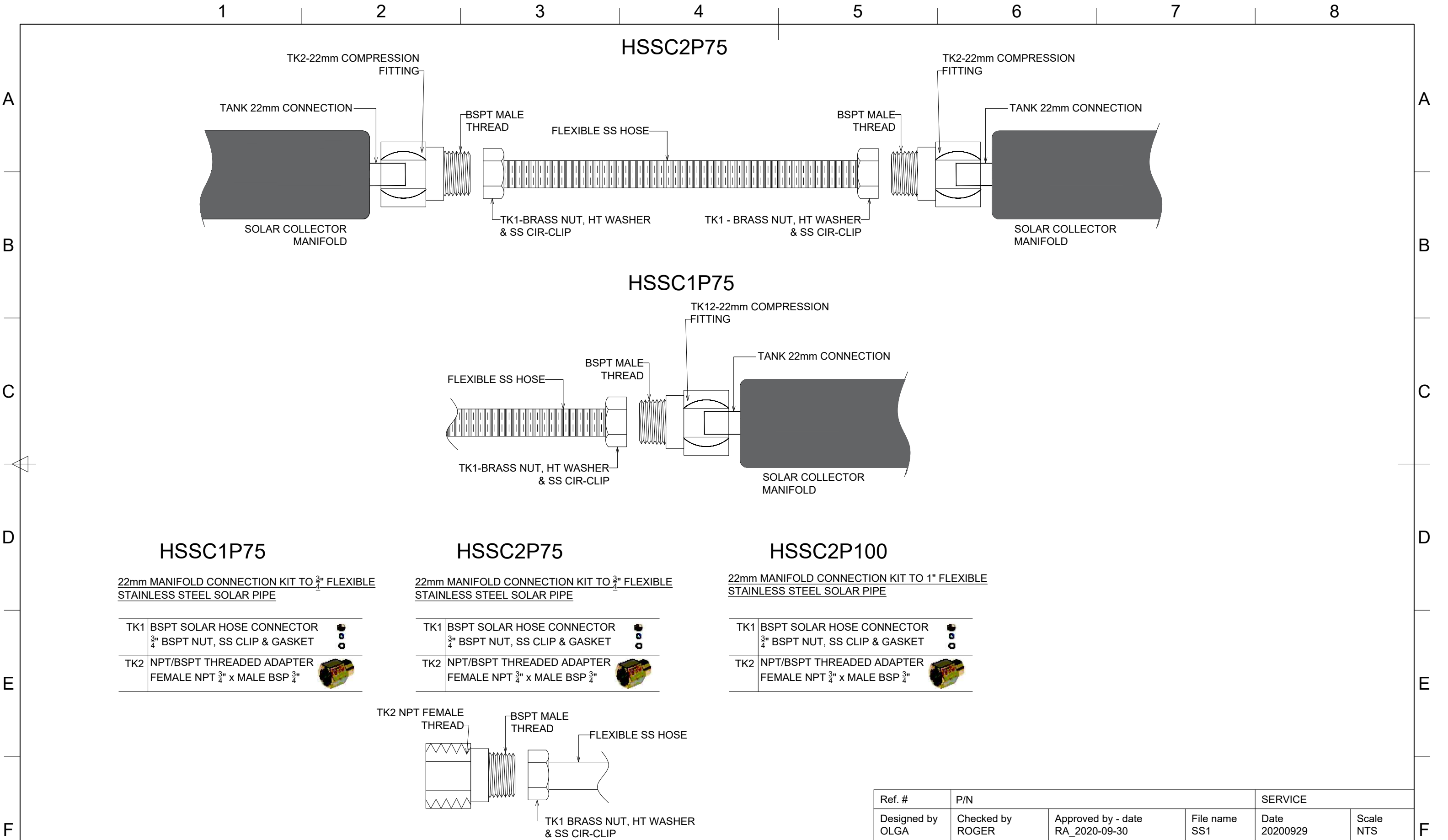

HSSC1P75

22mm MANIFOLD CONNECTION KIT TO 3/4" FLEXIBLE STAINLESS STEEL SOLAR PIPE

TK1	BSPT SOLAR HOSE CONNECTOR 3/4" BSPT NUT, SS CLIP & GASKET	
TK2	NPT/BSPT THREADED ADAPTER FEMALE NPT 3/4" x MALE BSP 3/4"	

HSSC2P75

22mm MANIFOLD CONNECTION KIT TO 3/4" FLEXIBLE STAINLESS STEEL SOLAR PIPE

TK1	BSPT SOLAR HOSE CONNECTOR 3/4" BSPT NUT, SS CLIP & GASKET	
TK2	NPT/BSPT THREADED ADAPTER FEMALE NPT 3/4" x MALE BSP 3/4"	

HSSC2P100

22mm MANIFOLD CONNECTION KIT TO 1" FLEXIBLE STAINLESS STEEL SOLAR PIPE

TK1	BSPT SOLAR HOSE CONNECTOR 3/4" BSPT NUT, SS CLIP & GASKET	
TK2	NPT/BSPT THREADED ADAPTER FEMALE NPT 3/4" x MALE BSP 3/4"	

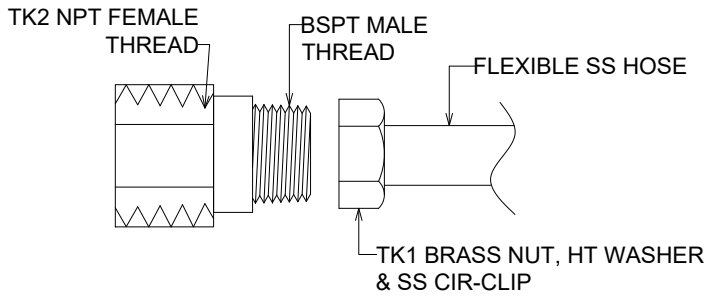

Ref. #	P/N	SERVICE	
Designed by OLGA	Checked by ROGER	Approved by - date RA_2020-09-30	File name SS1
		Date 20200929	Scale NTS

This drawing is the property of AQUA SOLANOR INC. It may not be used for any purpose other than the owner. AQUA SOLANOR INC does not authorize the reproduction or conveyance of any information contained herein without written permission.

AQUA SOLANOR
2459 46TH AVENUE, LACHINE (QC) H8T3C9

SOLAR_HEATING_KIT
DWG.NO.:SS215

RevNo	Revision note	Date	Signature	Checked
01	FOR SUBMISSION TO CLIENT	2020-09-29	RA	YES

Revision 0
Sheet DT-02