

SHIMPO

92856B

Aspire

Potter's Wheels Lever Handle & Foot Pedal Operation



Congratulations on your purchase of a Shimpo potter's wheel! We trust you will enjoy many years of professional results from your wheel. Please read the entire instruction manual thoroughly before initial set-up and operation. The information contained herein will aid you in operating your Shimpo wheel safely and with excellent results.

If you have any questions regarding our product(s), call your local Shimpo dealer.

NIDEC-SHIMPO AMERICA CORPORATION

Features and Benefits

The Aspire offers the power, resilience and quietness that Shimpo wheels are known for.

Features included:

- Heavy-duty steel frame construction assures long service life.
- Unique closed loop micro- controller maintains required speed under heavy load.
- Lever handle and foot pedal offer flexibility in speed adjustment.
- Two-year warranty.

Contents Included



Splash Pan : 1



Bat: 2

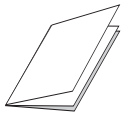

Instruction Manual.

Parts Description with Lever Handle or Foot Pedal

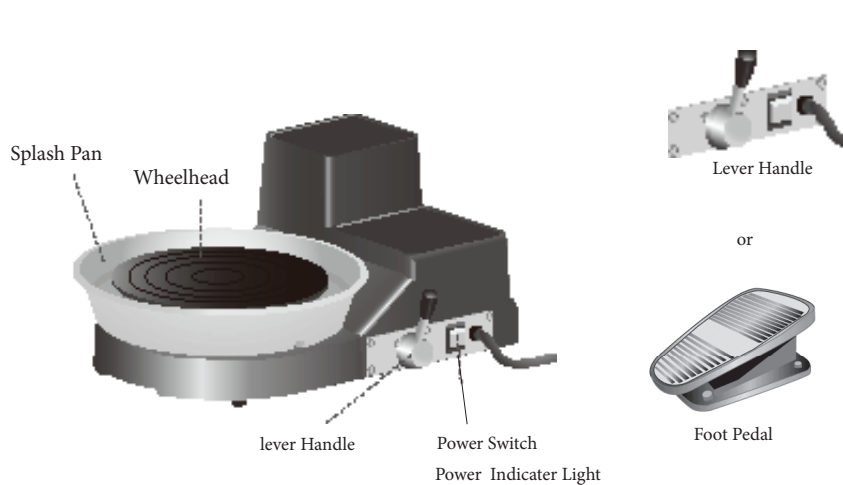

【Warning】 Please start to use the wheel only after you understand the safety information and functions of the equipment.

This instruction manual provides three grades of warnings as follows.
Please follow these instructions carefully.

 **Danger** Danger marking indicates possible death, severe injury or fire if the user disregards the warning.

 **Warning** Warning marking indicates the possibility of a severe injury if the user does not follow the instructions.

 **Caution** Caution marking indicates the possibility of light injury or damages if user operates the wheel improperly.

Extremely important markings to pay attention to:







 Warning, Pay Close Attention

 Do Not

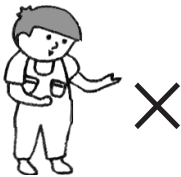
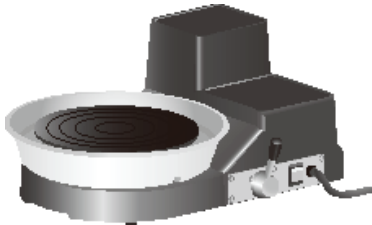

 Please Follow Instructions

Shimpo will not indemnify any damages or losses caused by improper operation due to the lack of following the instruction manual, natural disaster, fire, or user's abuse or negligence.

⚠ Danger

<p> Do not use the wheel other than for throwing clay.</p> <p>This product is designed for the creation of ceramic art.</p>	<p> Do not place any items other than ceramic materials on the wheelhead.</p> <p>Water buckets and tools should be placed on the attached workspace.</p>
<p> Repairs and modifications by the user are prohibited.</p> <p>May cause electrocution or injury.</p>	<p> Do not insert hands or objects into openings or moving parts.</p> <p>May cause electrocution or injury.</p>
<p> Do not leave children unattended near wheel.</p> <p style="text-align: right;">Injury may occur</p> <div style="display: flex; justify-content: center; align-items: center;">   </div>	
<p> Stop operation of the wheel if you smell or see smoke or hear unusual noises.</p> <p>Shut off the power, unplug power cable and contact the Shimpo dealer or Shimpo.</p>	

⚠ Warning

<p> Handle with extreme care when moving or lifting.</p> <p>Serious injury can occur if moving or lifting is done improperly.</p>	<p> Do not plug into or unplug from AC outlet with wet hands.</p> <p>May cause electrocution.</p> 
--	--



Do not move or hold the wheel while power is on.

The wheelhead may start turning and your hand may be caught between the wheelhead and the enclosure.



Be careful of loose fitting clothing and long hair.

May catch in clay or wheelhead causing damage or injury.



Caution



Do not lift the wheel by the wheelhead.

May cause damage or injury.



Be careful of jewelry and long nails.

Jewelry may catch in equipment and cause damage or injury. Nails may be broken.



Place the wheel on a flat, horizontal surface.

It may cause a vibration if the placement is not level.

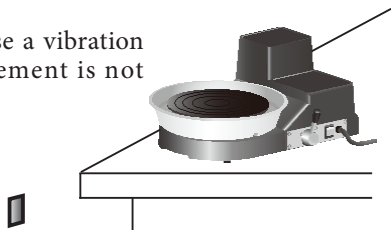

Do not remove the bottom cover.

There are electrical parts which need to be protected from hands, water and other materials.



Do not place a TV, radio, or an antenna too close to the wheel.

It may cause noise and picture distortion.

Splash Pan Installation

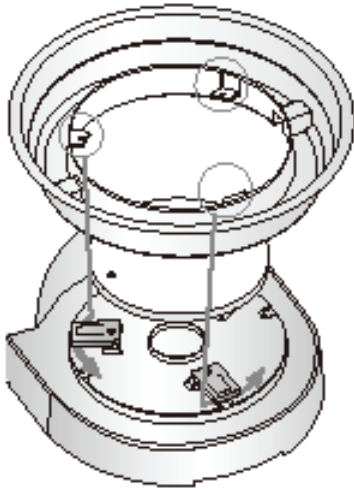

① Put splash pan on and turn it to the left to lock into place.



If water or clay is filled over this line, it overflows to the inside.

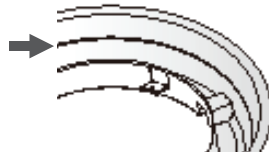

Bat Placement

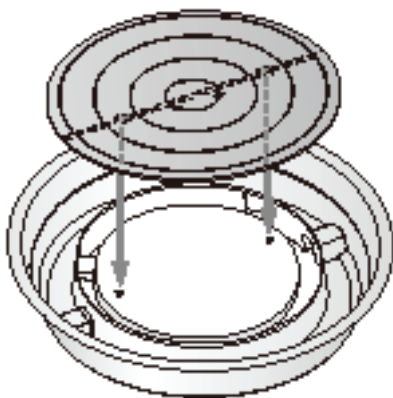

① Install bat on wheelhead by lining up the slot on the bottom of the bat with the bat pins on the wheelhead and press down "FIRMLY".

Power Connection



Please do not use this wheel with any voltage or frequency other than what is indicated.

Confirm that you have the correct line voltage and then insert power plug into the power outlet.

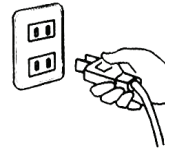

Do not connect many power cables to the same outlet.

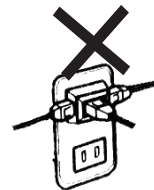

Make sure the power switch is off when you plug the power cable into the AC outlet.

Operation Warning



Press the lever handle or foot pedal all the way back before turning the power.

The wheelhead will not move if the lever handle or foot pedal was not all the way back at last power off.



Do not operate any switches with wet hands.

Lever Handle Operation Starting & Stopping

Start

- ① Turn the power switch on.

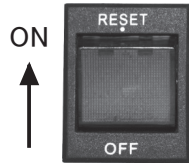

- ② Press the lever handle from the stop position to increase speed. Move the lever toward you to reduce speed.

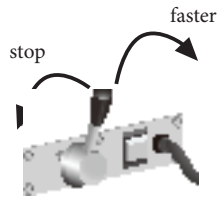

Stop

- ① Press the lever handle all the way back to stop wheelhead.

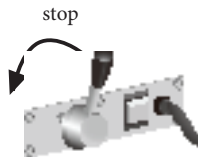

- ② Turn the power switch off.

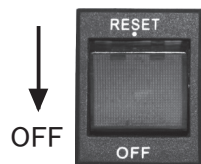

Lever Handle Operation Power Switch

The power switch has two functions. One is to turn wheel on and off. The other is a reset function. This wheel has a safety feature for overload. In order to reset, operator must switch off and on again. (Don't forget to pull the lever handle all the way down to "STOP" before turning switch back on.)

- ① Switch the on switch to the off position (refer to diagram).
- ② Return the lever handle to the off position (refer to diagram).
- ③ Turn the power switch back on.

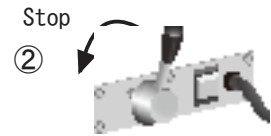
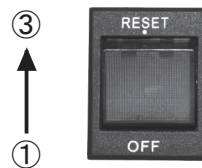

Maintenance

Use caution when performing any maintenance, inspection, and adjustments.



Turn the power switch off and unplug the power cable for cleaning, testing or adjustment. (It is recommended to do the same if the wheel will not be in use for a long period.)



DO NOT POUR WATER ON THE WHEEL TO CLEAN IT.

Wipe the wheel down with a damp sponge or cloth. (Splash pan can be cleaned if it is removed from the wheel.)

Foot Pedal Operation Starting and Stopping

Start

- ① Turn the power switch on.

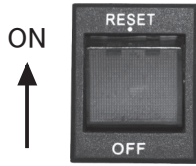

- ③ Press the pedal forward from the stop position to increase speed. Step backward to reduce speed.

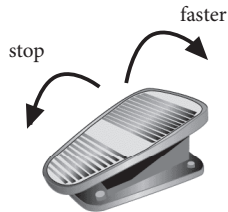

Stop

- ① Press the pedal all the way back to stop wheelhead.

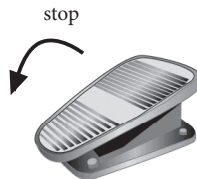

- ② Turn the power switch off.

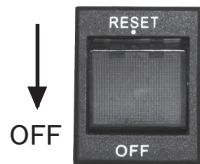

Foot Pedal Operation Power Switch

The power switch has two functions. One is to turn wheel on and off. The other is a reset function. This wheel has a safety feature for overload. In order to reset, operator must switch off and on again. (Don't forget to press the pedal all the way down to "STOP" before turning switch back on.)

Switch the on switch to the off position (refer to diagram).

Return the foot pedal to the off position (refer to diagram).

Turn the power switch back on.

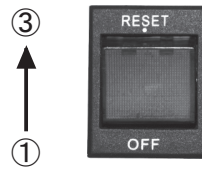

Maintenance

Use caution when performing any maintenance, inspection, and adjustments.



Turn the power switch off and unplug the power cable for cleaning, testing or adjustment. (It is recommended to do the same if the wheel will not be in use for a long period.)



DO NOT POUR WATER ON THE WHEEL TO CLEAN IT. Wipe the wheel down with a damp sponge or cloth. (Splash pan can be cleaned if it is removed from the wheel.)

Foot Pedal Tension Adjustment

Loosen nuts on the right side of foot pedal in order to adjust the pressure needed to move the pedal.

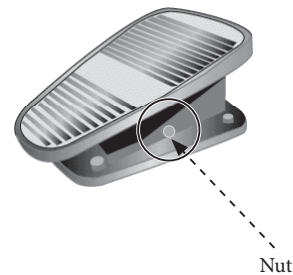

Troubleshooting

Problem Wheelhead does not turn

- Is the wheel plugged in to the power source?
- Is the power switch in the "on" position?
- Is the power source working correctly and supplying the correct amount of electrical current?
- Is the lever handle or foot pedal at the stop "0" position?
- Are there several wheels or other equipment/appliances on the same circuit?
(Check the breaker to see if the circuit has been overloaded.)

Problem Unusual sound coming from the wheel body

- Is the wheel resting on a solid surface and level?
- Is there too much clay on the wheelhead?
- Is the clay totally centered?

Problem The wheelhead stops turning

- Did the wheel stop turning due to too much clay on the wheelhead?
- Did an overload cause the breaker to open at the main power source?
- Has the power cord become unplugged?
- Is the Power Switch in the on Position?

Manufactured by

NIDEC-SHIMPO AMERICA CORPORATION

1701 Glenlake Avenue Itasca, IL 60143 USA
Phone: (800) 237-7097 FAX: (630) 924-0340